

**Engwinklige LED im MIDLLED-Gehäuse (940 nm)**  
**Narrow beam LED in MIDLLED package (940 nm)**  
**Lead (Pb) Free Product - RoHS Compliant**

**SFH 4641**  
**SFH 4646**

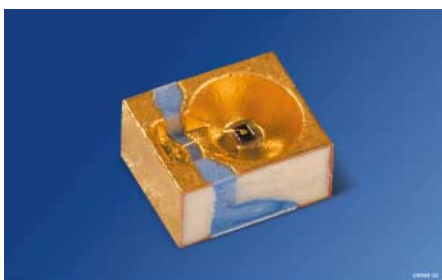

SFH 4641

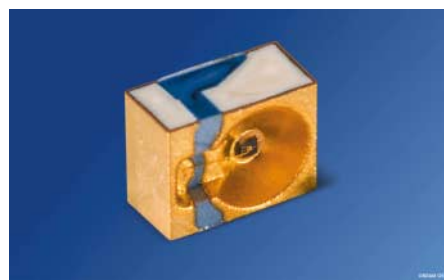

SFH 4646

**Wesentliche Merkmale**

- Infrarot LED mit hoher Ausgangsleistung
- Kurze Schaltzeiten
- Enger Abstrahlwinkel ( $\pm 15^\circ$ )
- Geringe Bauhöhe
- Als Toplooker und Sidelooker einsetzbar
- SFH 4641: Gurtung als Toplooker
- SFH 4646: Gurtung als Sidelooker

**Anwendungen**

- Infrarotbeleuchtung für Kameras
- IR-Datenübertragung
- Sensorik in der Automobiltechnik
- Fernsteuerung

**Sicherheitshinweise**

Je nach Betriebsart emittieren diese Bauteile hochkonzentrierte, nicht sichtbare Infrarot-Strahlung, die gefährlich für das menschliche Auge sein kann. Produkte, die diese Bauteile enthalten, müssen gemäß den Sicherheitsrichtlinien der IEC-Normen 60825-1 und 62471 behandelt werden.

**Features**

- High Power Infrared LED
- Short switching times
- Narrow halfangle ( $\pm 15^\circ$ )
- Low profile component
- Usable as top-looking and side-looking device
- SFH 4641: Taping as Toplooker
- SFH 4646: Taping as Sidelooker

**Applications**

- Infrared Illumination for cameras
- IR Data Transmission
- Automotive sensors
- Remote controls

**Safety Advices**

Depending on the mode of operation, these devices emit highly concentrated non visible infrared light which can be hazardous to the human eye. Products which incorporate these devices have to follow the safety precautions given in IEC 60825-1 and IEC 62471.

Typ Type	Bestellnummer Ordering Code	Strahlstärkegruppierung <sup>1)</sup> ( $I_F = 70 \text{ mA}$ , $t_p = 20 \text{ ms}$ ) Radiant Intensity Grouping <sup>1)</sup> $I_e \text{ (mW/sr)}$
SFH 4641	Q65110A8098	$\geq 16 \text{ (typ. 40)}$
SFH 4646	Q65110A8099	$\geq 16 \text{ (typ. 40)}$

<sup>1)</sup> gemessen bei einem Raumwinkel  $\Omega = 0.01 \text{ sr}$  / measured at a solid angle of  $\Omega = 0.01 \text{ sr}$

**Grenzwerte** ( $T_A = 25\text{ °C}$ )**Maximum Ratings**

Bezeichnung Parameter	Symbol Symbol	Wert Value	Einheit Unit
Betriebs- und Lagertemperatur Operating and storage temperature range	$T_{op}, T_{stg}$	- 40 ... + 100	°C
Sperrspannung Reverse voltage	$V_R$	5	V
Vorwärtsgleichstrom Forward current	$I_F$	70	mA
Stoßstrom, $t_p = 25\text{ }\mu\text{s}$ , $D = 0$ Surge current	$I_{FSM}$	700	mA
Verlustleistung Power dissipation	$P_{tot}$	140	mW
Wärmewiderstand Sperrschicht - Umgebung bei Montage auf FR4 Platine, Padgröße je $16\text{ mm}^2$ Thermal resistance junction - ambient mounted on PC-board (FR4), pads size $16\text{ mm}^2$ each	$R_{thJA}$	380	K/W
Wärmewiderstand Sperrschicht - Lötstelle bei Montage auf Metall-Block Thermal resistance junction - soldering point, mounted on metal block	$R_{thJS}$	220	K/W

**Kennwerte** ( $T_A = 25\text{ °C}$ )**Characteristics**

Bezeichnung Parameter	Symbol Symbol	Wert Value	Einheit Unit
Wellenlänge der Strahlung Wavelength at peak emission $I_F = 70\text{ mA}$	$\lambda_{peak}$	950	nm
Centroid-Wellenlänge der Strahlung Centroid wavelength $I_F = 70\text{ mA}$	$\lambda_{centroid}$	940	nm
Spektrale Bandbreite bei 50% von $I_{max}$ Spectral bandwidth at 50% of $I_{max}$ $I_F = 70\text{ mA}$	$\Delta\lambda$	42	nm
Abstrahlwinkel Half angle	$\varphi$	$\pm 15$	Grad deg.
Aktive Chipfläche Active chip area	$A$	0.04	$\text{mm}^2$

**Kennwerte** ( $T_A = 25\text{ °C}$ )  
**Characteristics** (cont'd)

Bezeichnung Parameter	Symbol Symbol	Wert Value	Einheit Unit
Abmessungen der aktiven Chipfläche Dimension of the active chip area	$L \times B$ $L \times W$	$0.2 \times 0.2$	mm <sup>2</sup>
Schaltzeiten, $I_e$ von 10% auf 90% und von 90% auf 10%, bei $I_F = 70\text{ mA}$ , $R_L = 50\ \Omega$ Switching times, $I_e$ from 10% to 90% and from 90% to 10%, $I_F = 70\text{ mA}$ , $R_L = 50\ \Omega$	$t_r$ , $t_f$	11	ns
Durchlassspannung Forward voltage $I_F = 70\text{ mA}$ , $t_p = 20\text{ ms}$ $I_F = 500\text{ mA}$ , $t_p = 100\ \mu\text{s}$	$V_F$ $V_F$	1.6 (< 2.0) 2.4 (< 3.0)	V V
Sperrstrom Reverse current	$I_R$	not designed for reverse operation	$\mu\text{A}$
Gesamtstrahlungsfluss Total radiant flux $I_F = 70\text{ mA}$ , $t_p = 20\text{ ms}$	$\Phi_{e\text{ typ}}$	33	mW
Temperaturkoeffizient von $I_e$ bzw. $\Phi_e$ , $I_F = 70\text{ mA}$ Temperature coefficient of $I_e$ or $\Phi_e$ , $I_F = 70\text{ mA}$	$TC_I$	- 0.5	%/K
Temperaturkoeffizient von $V_F$ , $I_F = 70\text{ mA}$ Temperature coefficient of $V_F$ , $I_F = 70\text{ mA}$	$TC_V$	- 3.5	mV/K
Temperaturkoeffizient von $\lambda$ , $I_F = 70\text{ mA}$ Temperature coefficient of $\lambda$ , $I_F = 70\text{ mA}$	$TC_\lambda$	+ 0.3	nm/K

**Strahlstärke  $I_e$  in Achsrichtung<sup>1)</sup>**

gemessen bei einem Raumwinkel  $\Omega = 0.01$  sr

**Radiant Intensity  $I_e$  in Axial Direction**

at a solid angle of  $\Omega = 0.01$  sr

Bezeichnung Parameter	Symbol	Werte Values				Einheit Unit
		-S	-T	-U	-V	
Strahlstärke Radiant intensity $I_F = 70$ mA, $t_p = 20$ ms	$I_{e \text{ min}}$ $I_{e \text{ max}}$	16 32	25 50	40 80	63 125	mW/sr mW/sr
Strahlstärke Radiant intensity $I_F = 500$ mA, $t_p = 25$ $\mu$ s	$I_{e \text{ typ}}$	120	185	295	465	mW/sr

<sup>1)</sup> Nur eine Gruppe in einer Verpackungseinheit (Streuung kleiner 2:1) /  
Only one bin in one packing unit (variation lower 2:1)

**Abstrahlcharakteristik**

**Radiation Characteristics  $I_{rel} = f(\varphi)$**

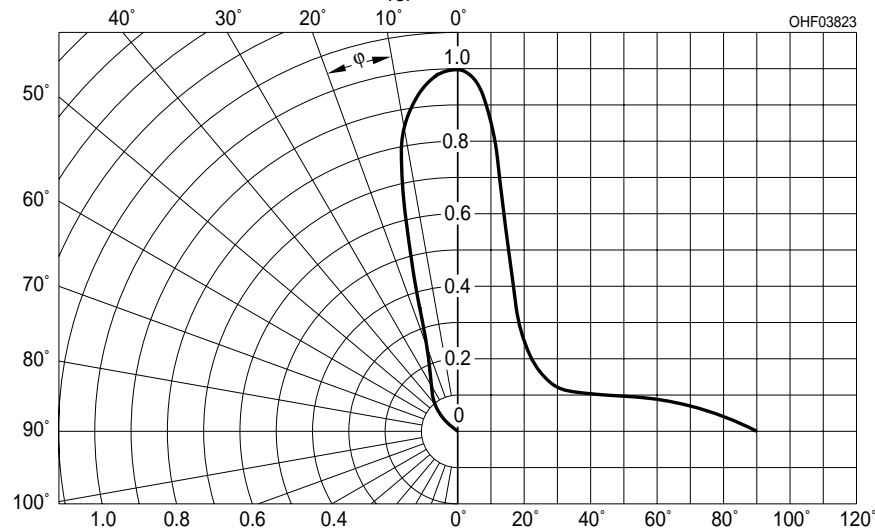

**Relative Spectral Emission**

$I_{rel} = f(\lambda)$

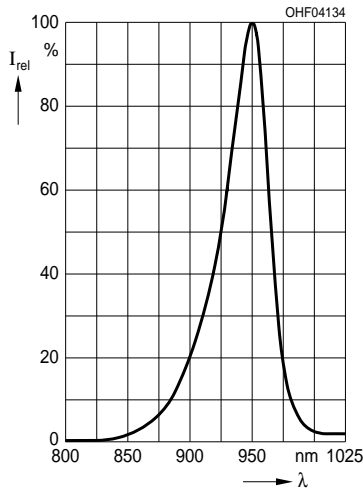

**Forward Current  $I_F = f(V_F)$**

Single pulse,  $t_p = 100 \mu s$

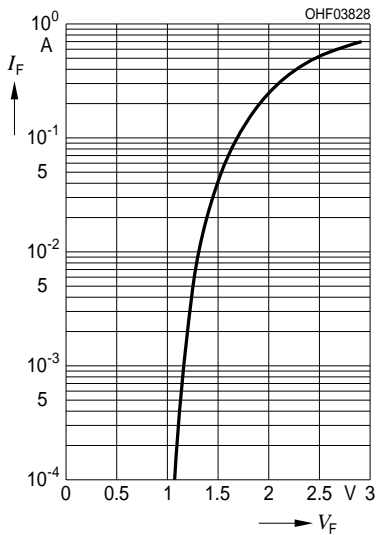

**Radiant Intensity  $\frac{I_e}{I_e(70 \text{ mA})} = f(I_F)$**

Single pulse,  $t_p = 25 \mu s$

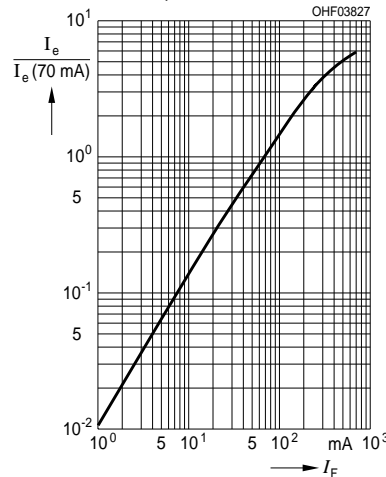

**Max. Permissible Forward Current**

$I_F = f(T_A), R_{thJA} = 380 \text{ K/W}$

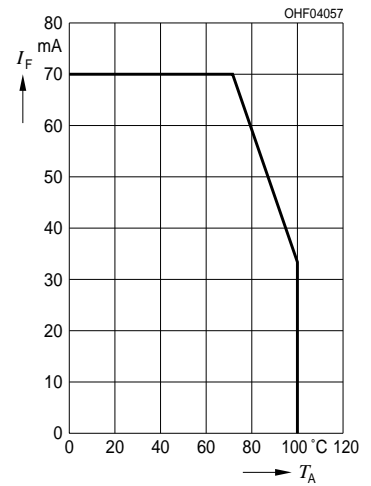

**Permissible Pulse Handling Capability  $I_F = f(\tau), T_A = 25 \text{ °C}$ , duty cycle  $D =$  parameter**

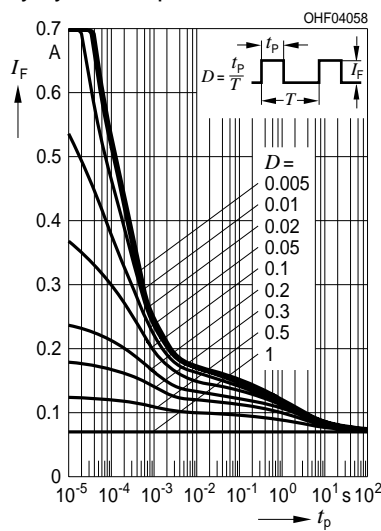

**Permissible Pulse Handling Capability  $I_F = f(\tau), T_A = 85 \text{ °C}$ , duty cycle  $D =$  parameter**

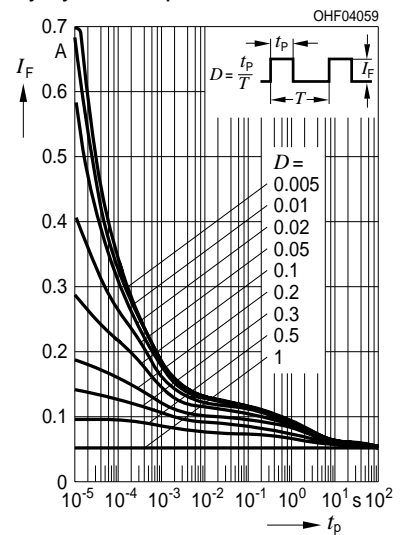

**Maßzeichnung**  
**Package Outlines**

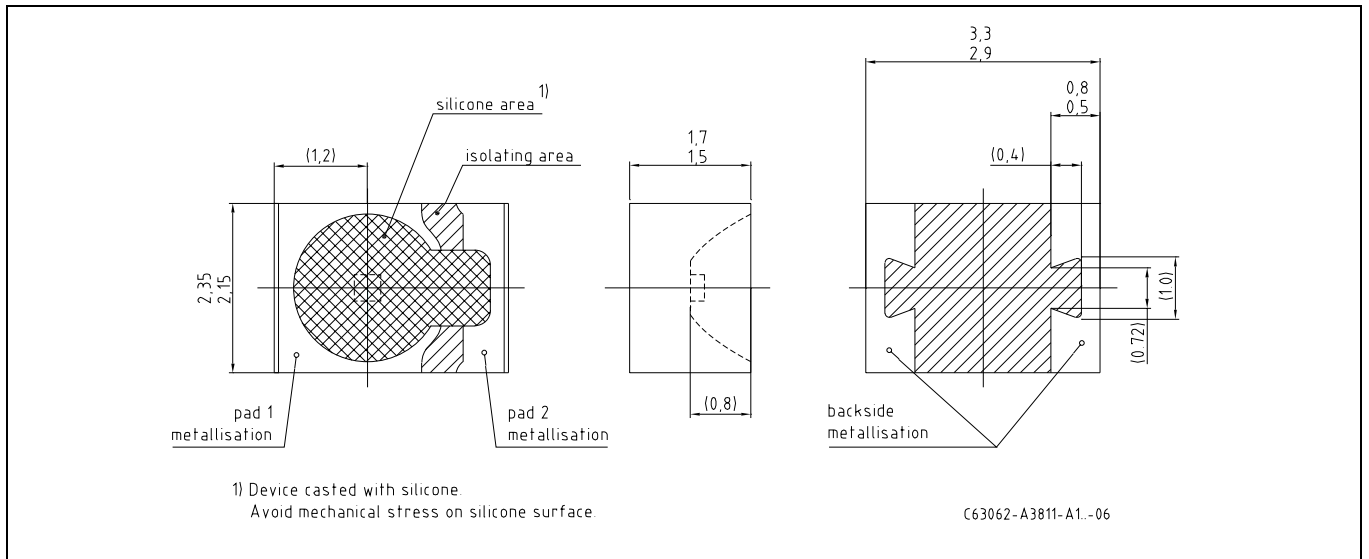

Maße in mm / Dimensions in mm.

Gehäuse / Package	MID mit klarem Silikonverguss / MID casted with clear Silicone
Anschlussbelegung Pin configuration	Pad 1 = Anode / anode Pad 2 = Kathode / cathode

Gurtung / Polarität und Lage

Verpackungseinheit 2000/Rolle, ø180 mm  
oder 9000/Rolle, ø330 mm

Method of Taping / Polarity and Orientation

Packing unit 2000/reel, ø180 mm  
or 9000/reel, ø330 mm

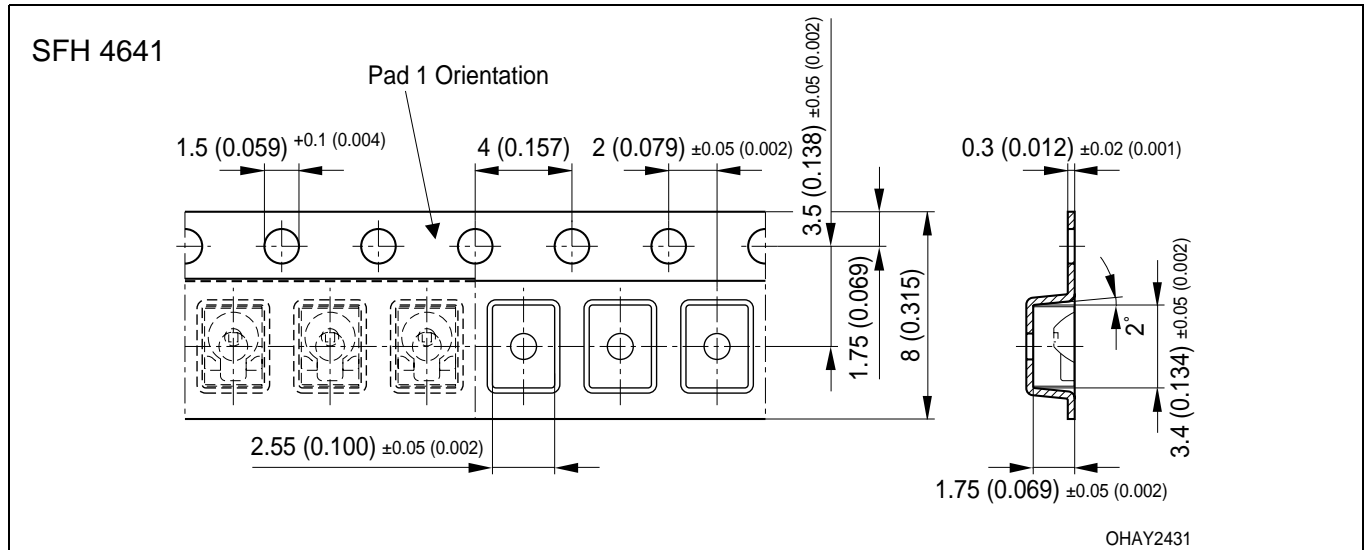

Maße in mm (inch) / Dimensions in mm (inch).

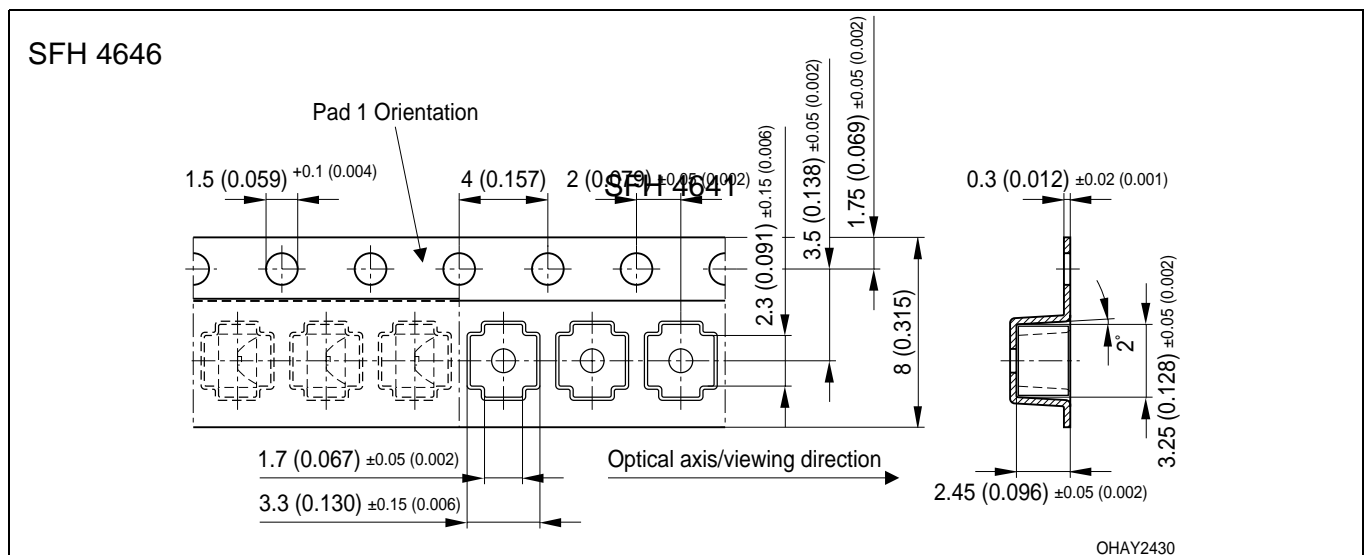

Maße in mm (inch) / Dimensions in mm (inch).

**Empfohlenes Lötpaddesign**  
**Recommended Solder Pad Design**

SFH 4641

Padgeometrie für verbesserte Wärmeableitung  
 Pad design for improved heat dissipation

Cu-Fläche > 16 mm<sup>2</sup>  
 Cu-area

 Lötstopplack  
 Solder resist

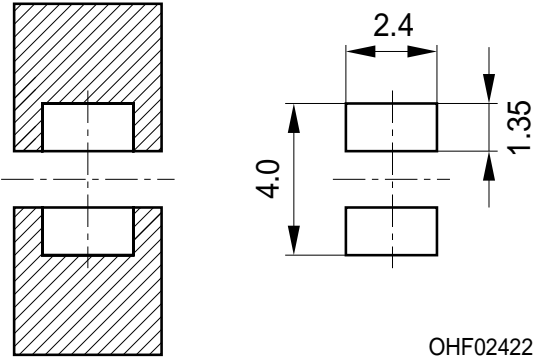

OHF02422

SFH 4646

Padgeometrie für verbesserte Wärmeableitung  
 Pad design for improved heat dissipation

Cu-Fläche > 16 mm<sup>2</sup>  
 Cu-area

 Lötstopplack  
 Solder resist

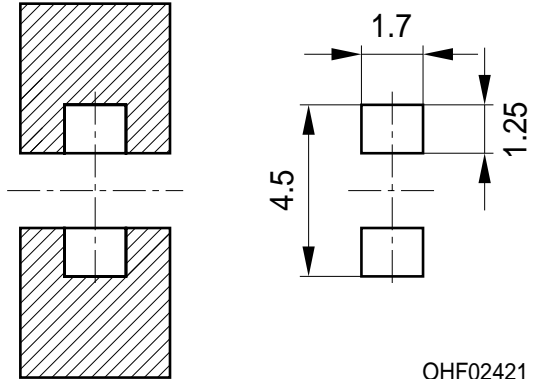

OHF02421

Maße in mm / Dimensions in mm.

**Verarbeitungshinweis:** Das Gehäuse ist mit Silikon vergossen. Mechanischer Stress auf der Bauteiloberfläche sollte so gering wie möglich gehalten werden.

**Handling indication:** The package is casted with silicone. Mechanical stress at the surface of the unit should be as low as possible.



**Lötbedingungen**  
**Soldering Conditions**  
**Reflow Lötprofil für bleifreies Löten**  
**Reflow Soldering Profile for lead free soldering**

Vorbehandlung nach JEDEC Level 2  
 Preconditioning acc. to JEDEC Level 2  
 (nach J-STD-020C)  
 (acc. to J-STD-020C)

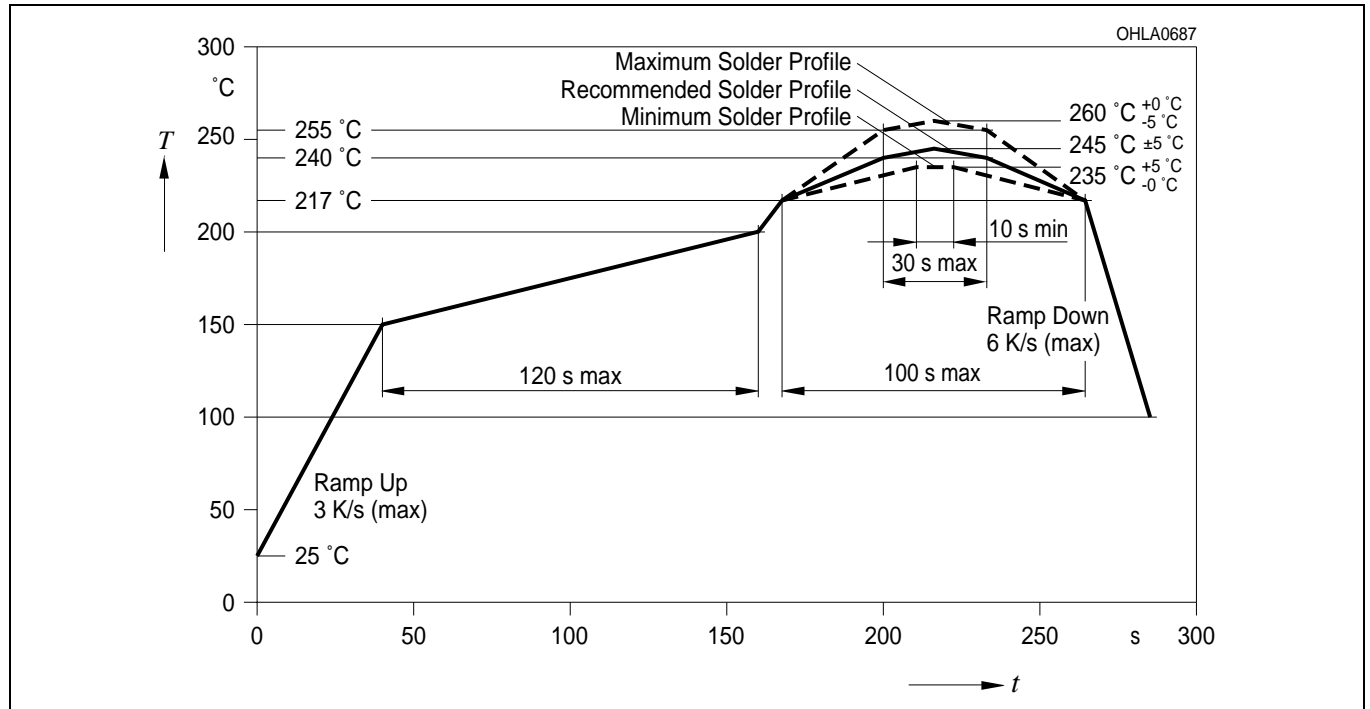

**Published by**  
**OSRAM Opto Semiconductors GmbH**  
 Leibnizstraße 4, D-93055 Regensburg  
[www.osram-os.com](http://www.osram-os.com)  
 © All Rights Reserved.

EU RoHS and China RoHS compliant product



此产品符合欧盟 RoHS 指令的要求；  
 按照中国的相关法规和标准，不含有毒有害物质或元素。

The information describes the type of component and shall not be considered as assured characteristics. Terms of delivery and rights to change design reserved. Due to technical requirements components may contain dangerous substances. For information on the types in question please contact our Sales Organization.

**Packing**

Please use the recycling operators known to you. We can also help you – get in touch with your nearest sales office. By agreement we will take packing material back, if it is sorted. You must bear the costs of transport. For packing material that is returned to us unsorted or which we are not obliged to accept, we shall have to invoice you for any costs incurred.

**Components used in life-support devices or systems must be expressly authorized for such purpose!** Critical components <sup>1</sup>, may only be used in life-support devices or systems <sup>2</sup> with the express written approval of OSRAM OS.

<sup>1</sup> A critical component is a component used in a life-support device or system whose failure can reasonably be expected to cause the failure of that life-support device or system, or to affect its safety or effectiveness of that device or system.

<sup>2</sup> Life support devices or systems are intended (a) to be implanted in the human body, or (b) to support and/or maintain and sustain human life. If they fail, it is reasonable to assume that the health of the user may be endangered.