

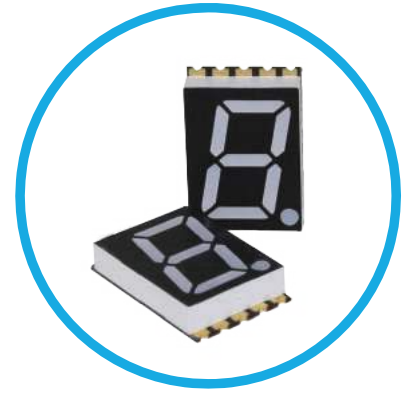

DSM7T Series

Thin Surface Mount Single Digit 7-Segment LED Numeric Display



DSM7TA56106T - 0.56" (14.22mm) Digit Height
Emitting Color: Blue (InGaN)

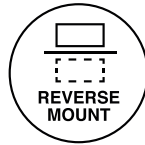
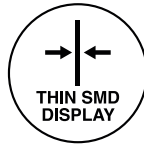

Application

- People Movers
- Home Appliances
- Medical Devices
- Industrial Devices
- Automation and Controls
- Light Control
- IoT
- Transportation
- Food Service Appliances

Key features

- 1-digit seven segment led numeric display
- Includes a decimal point (DP), useful when two or more seven-segment displays are connected to each other to display decimals
- White segments and black surface
- Substrate: InGaN
- Outer dimensions: 17.0 x 12.5 x 3.85mm
- High light output
- Excellent character appearance
- Quality tested with the highest industry standard
- Side by side mounting allows space saving
- Provides the ability to reduce overall thickness of PCB, with major cost savings
- Available in 3 different digit heights and widths
- Automation-friendly tape and reel
- Technically and mechanically rugged
- Small and light, easy assembly
- Life expectancy: up to 50,000 hours
- Lower power consumption
- Allow top mount and reverse mount design
- Mechanically rugged
- Moisture Sensitive Level (MSL): 2a
- Available in blue, red and pure green
- Polarity: common anode
- Easy mounting on PC boards or sockets
- Low current operation
- Degree of protection IP50 (Dust-Protected)

Ordering Data

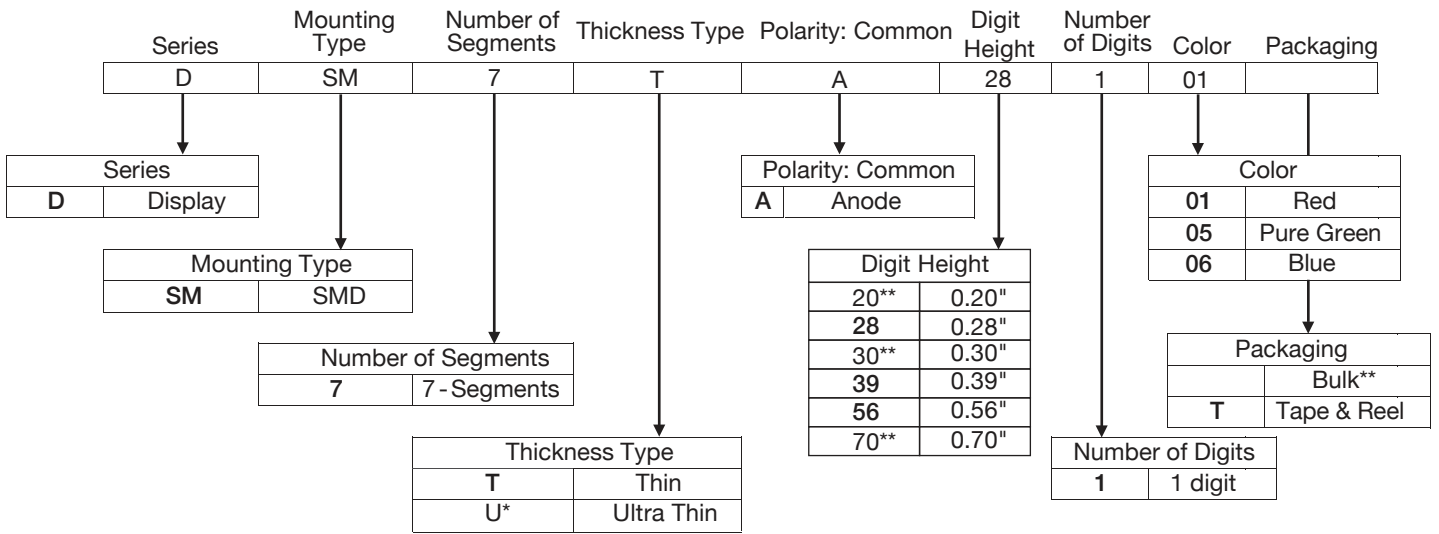

*Please refer to DSM7U product datasheet for Ultra Thin Version
 **Only available for DSM7U Version

Dimensions and Internal Circuit Diagram

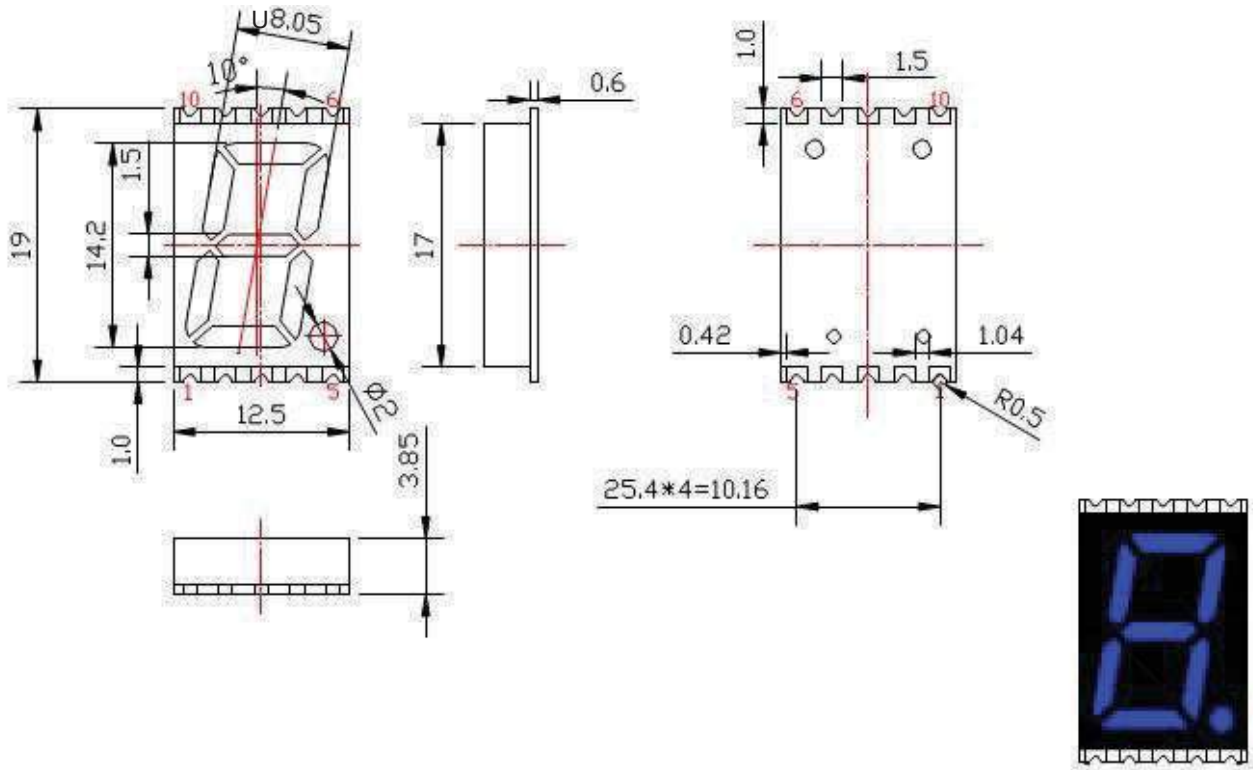

Dimensions in millimeters
 Tolerance is ± 0.25 mm unless otherwise noted

Internal Circuit Diagram

Pin Connections (Common Anode)

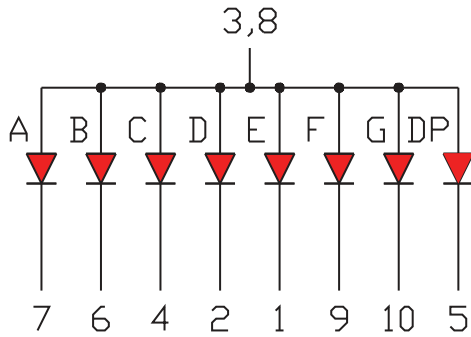

PIN No	Connection
1	CATHODE E
2	CATHODE D
3	COMMON ANODE
4	CATHODE C
5	CATHODE DP
6	CATHODE B
7	CATHODE A
8	COMMON ANODE
9	CATHODE F
10	CATHODE G

Product Specifications

Absolute Maximum Ratings while $T_a=25^\circ\text{C}$

Parameter	Minimum (m)	Maximum (M)	Unit
Forward Current I_F /Seg	--	20	mA
Reverse Voltage V_R /Seg	--	5	V
Operating Temperature T_{OPR}	-30	+85	$^\circ\text{C}$
Storage Temperature T_{STG}	-40	+100	$^\circ\text{C}$
Peak Current I_{FM} /Seg	--	60	mA

(Notice: 1/10th duty cycle, 0.1ms pulse width)

Electrical-Optical Characteristics while $T_a=25^\circ\text{C}$

Parameter	Condition	Unit	Minimum	Typical	Maximum
Forward Voltage V_F /Seg	$I_F=20\text{mA}$	V	2.6	3.0	3.6
Reverse Current I_R /Seg	$V_R=5\text{V}$	μA	--	--	50
Wavelength λ_P	$I_F=20\text{mA}$	nm	465	470	475
Full Width at Half Maximum $\Delta\lambda$	$I_F=20\text{mA}$	nm	--	15	--
Luminosity I_V /Seg	$I_F=20\text{mA}$	mcd	80	125	175
Viewing angle	wide viewing angle				

Product Specifications

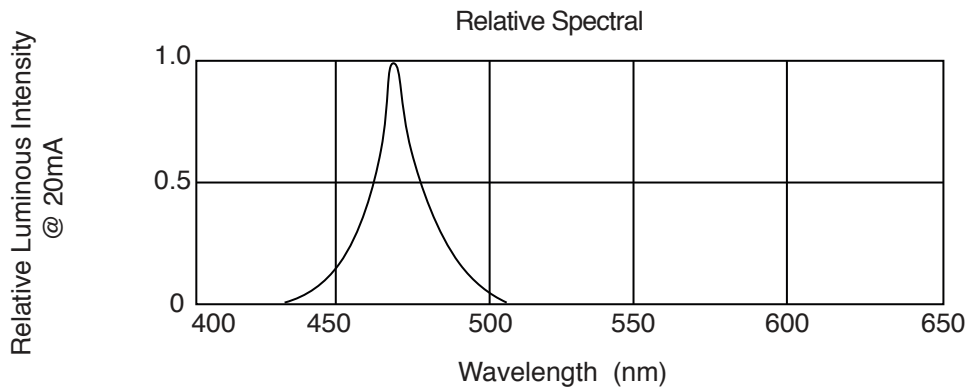

Forward Current vs. Forward Voltage

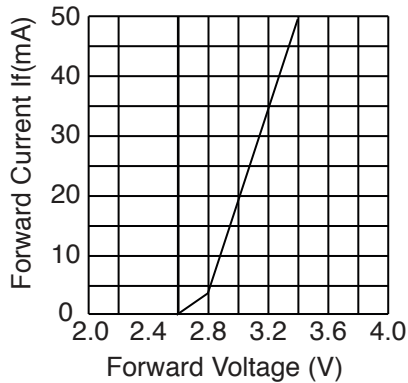

Relative Luminous Intensity vs. Forward current

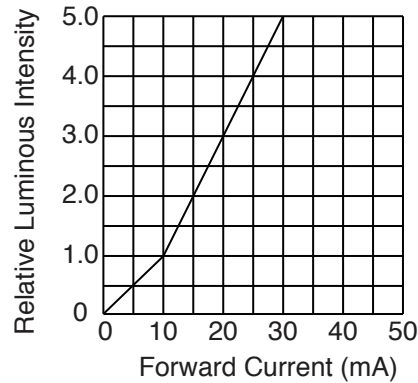

Forward Current Vs. Temperature

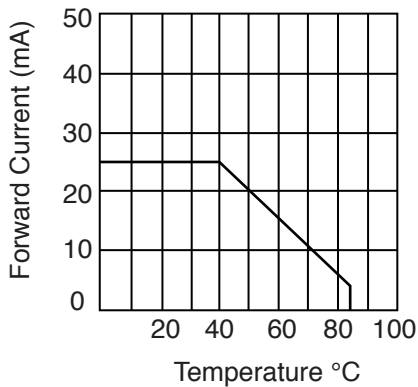

Luminous Intensity vs. Temperature

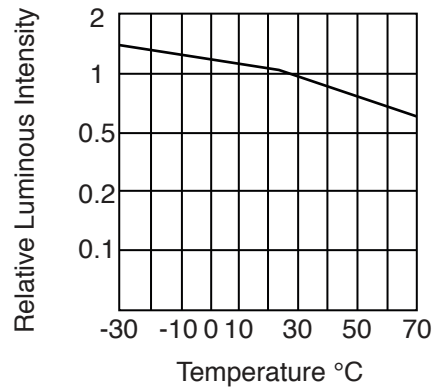

Circuit Design Notes

- Always use current limit resistors when necessary
- LEDs could be electrically connected in parallel, with each current limiting resistor

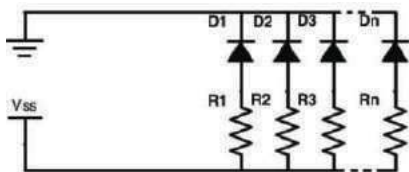

Correct

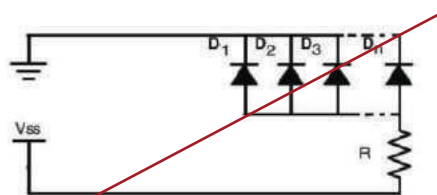

INCORRECT

Recommended Reflow Soldering Profile

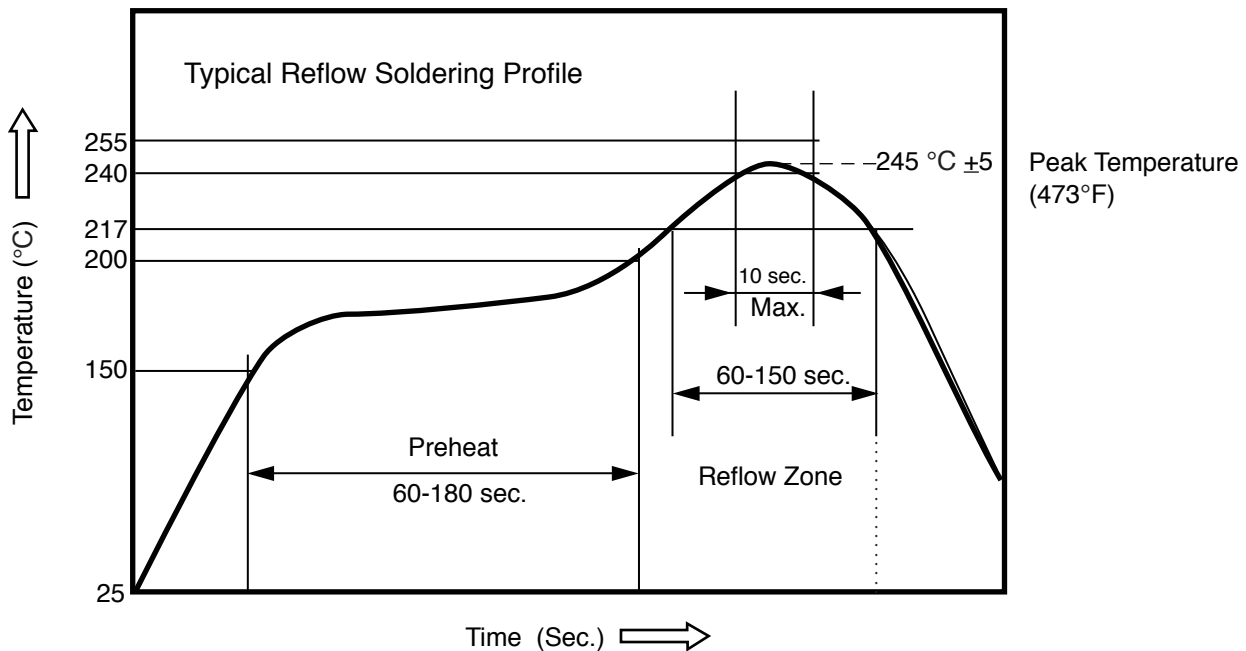

Profile Feature	Typical Parameters
Preheat Temperature Min	150 °C (302°F)
Preheat Temperature Max	200 °C (392°F)
Preheat Time	60 -180 sec.
Reflow Starting Temperature	217 °C (423°F)
Time Spent During Reflow	60 -150 sec.
Reflow Peak Temperature	245 °C (473°F)

- Manual soldering is suggested
 - Use soldering irons of which power is less than 30 Watt.
 - Keep the temperature of soldering irons below 360 °C
 - Only one soldering is allowed on each bonding pad.
 - The maximum time from when a soldering iron comes into contact with the parts that are to be connected until the joint is finished should not exceed three seconds.
 - Perform other procedures after the soldered pad cools down.
- Suggested storage conditions: 25°C +/-10°C (77°F +/-50°F), relative humidity 65% RH +/- 20% RH.

Tape and Reel Dimensions

Carrier band

Electrostatic Discharge (ESD) Package
Anti Static Bags Aluminium Moisture Barrier Bag.

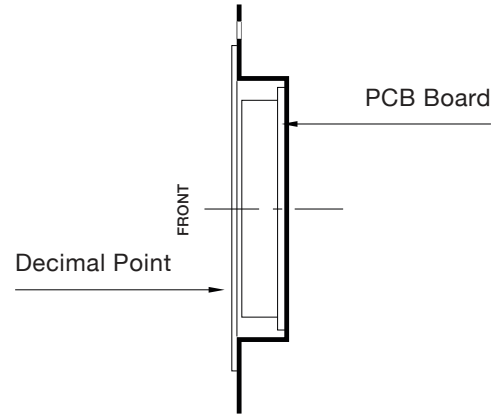
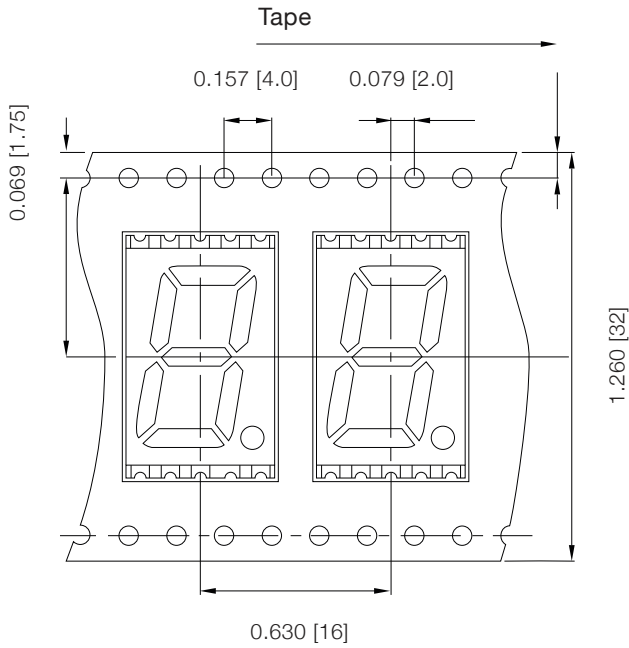

Reel Dimensions

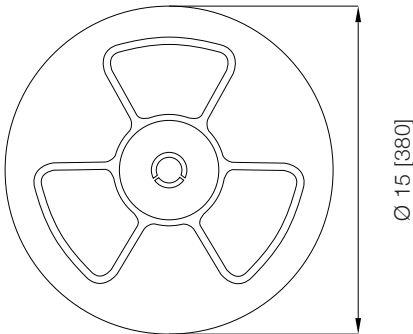

900PCS/Reel

Direction of the feed

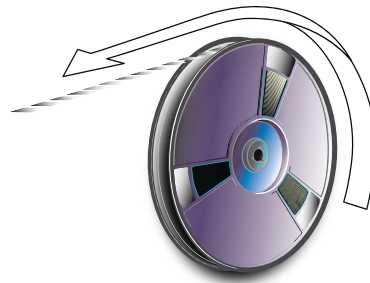

Allow top mount or reverse mount design

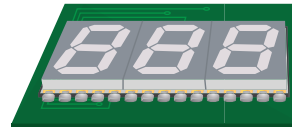

Top Mount



Reverse Mount

Dimensions in inches [millimeters]

Compliances and Approvals

