

**Mechanical Dimensions: Inches [mm]**

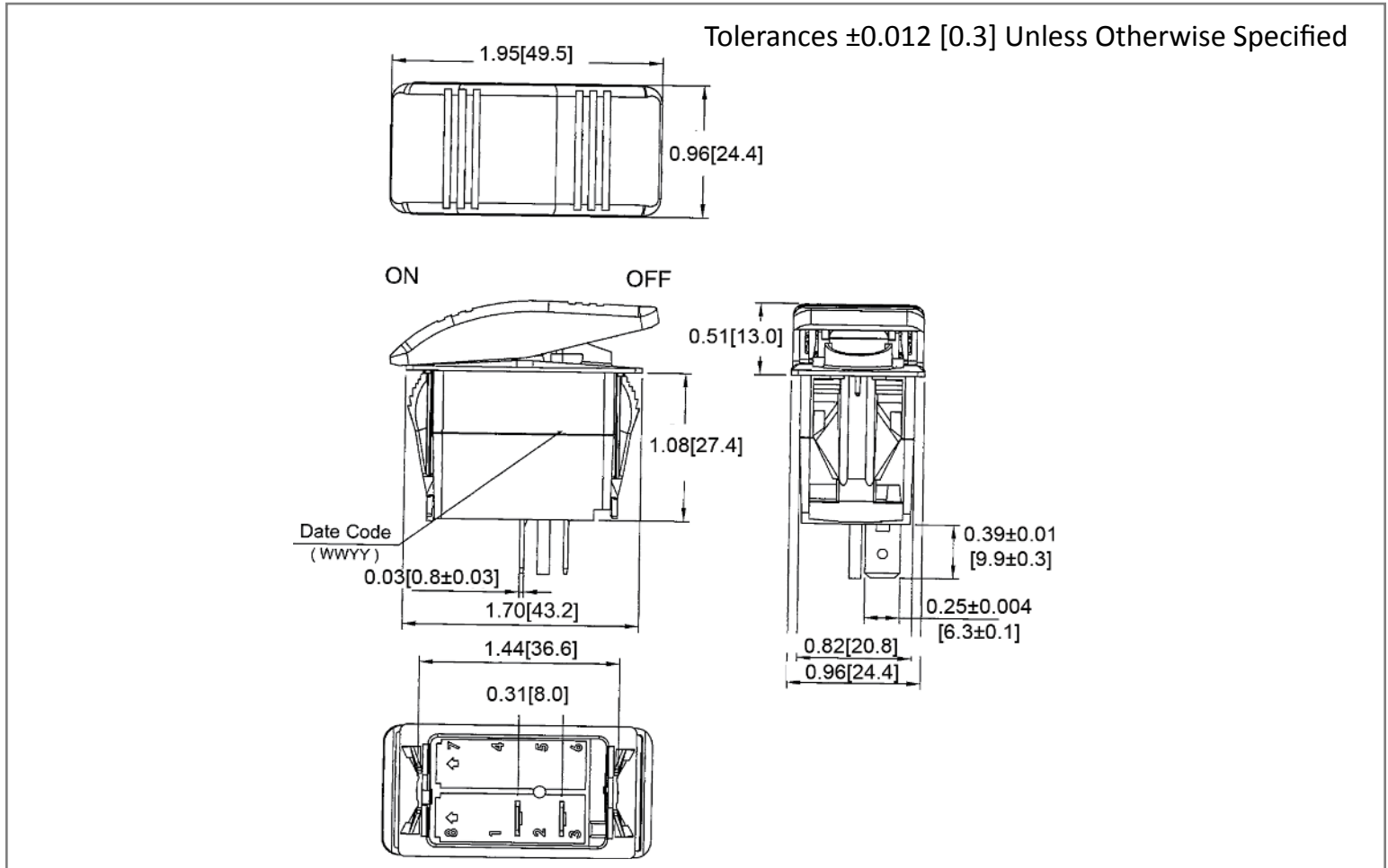

**Mounting Hole**

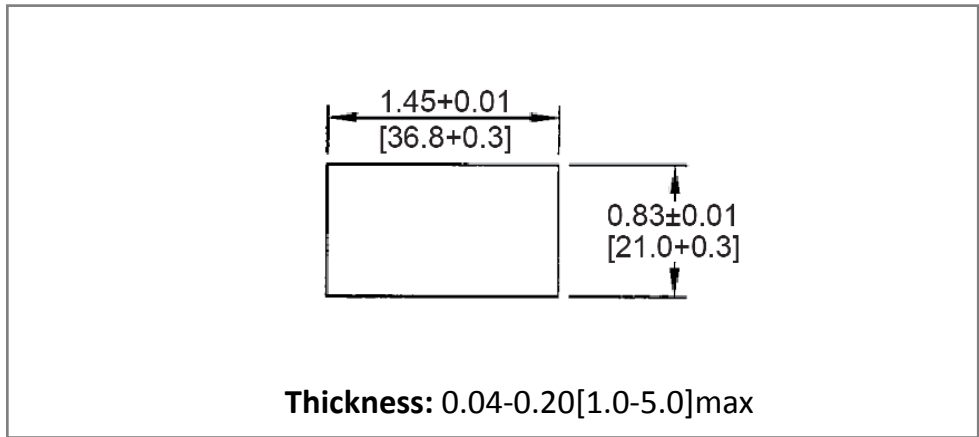

**Circuit Diagram**

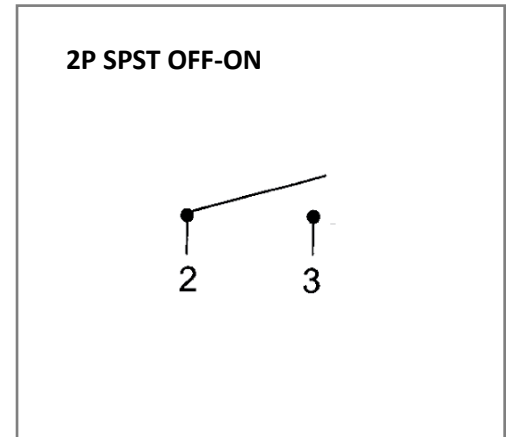

**Electrical Specifications**

Rating	21A 14V DC
Contact Resistance	50m ohm Max
Insulation Resistance	DC 500V 100M ohm Min
Dielectric Strength	AC 1500V 1 minute
Operation Temperature	-25°C~85°C

**Material Specifications**

Frame	Black, Nylon 66 (94V-2)
Actuator	Black, Nylon 66 (94V-2)
Terminals	Silver plated copper
Splash-proof	IP56

Rev	Date of issue	Revision Notes	Designed	Approved
B	06-25-2021	Initial Drawing	RC	OF