

Plug - PP-H 4/ 2 - 3212016

Please be informed that the data shown in this PDF Document is generated from our Online Catalog. Please find the complete data in the user's documentation. Our General Terms of Use for Downloads are valid (<http://phoenixcontact.com/download>)



Plug, Connection method: Push-in / plug connection, Number of positions: 2, Cross section: 0.2 mm² - 6 mm², AWG: 24 - 10, Width: 12.4 mm, Height: 42.3 mm, Color: gray

The figure shows a version of the article

Why buy this product

- Large-surface labeling option
- The Push-in technology COMBI plugs for self-assembly provide solutions that users can implement themselves
- Tested for railway applications

Key Commercial Data

| | |
|--------------------------------------|----------|
| Packing unit | 1 STK |
| Minimum order quantity | 50 STK |
| Weight per Piece (excluding packing) | 10.000 g |
| Custom tariff number | 85366990 |
| Country of origin | Poland |

Technical data

Environmental Product Compliance

| | |
|------------|--|
| China RoHS | No hazardous substances above threshold values |
|------------|--|

General

| | |
|-----------------------|-------------------|
| Number of positions | 2 |
| Number of levels | 1 |
| Number of connections | 2 |
| Potentials | 2 |
| Nominal cross section | 4 mm ² |
| Color | gray |

Plug - PP-H 4/ 2 - 3212016

Technical data

General

| | |
|---|---|
| Insulating material | PA |
| Flammability rating according to UL 94 | V0 |
| Area of application | Railway industry |
| | Machine building |
| | Plant engineering |
| Rated surge voltage | 8 kV |
| Degree of pollution | 3 |
| Overvoltage category | III |
| Insulating material group | I |
| Maximum load current | 32 A (with 6 mm ² conductor cross section) |
| Nominal current I _N | 32 A |
| Nominal voltage U _N | 800 V |
| Open side panel | No |
| Relative insulation material temperature index (Elec., UL 746 B) | 130 °C |
| Temperature index of insulation material (DIN EN 60216-1 (VDE 0304-21)) | 130 °C |
| Static insulating material application in cold | -60 °C |
| Behavior in fire for rail vehicles (DIN 5510-2) | Test passed |
| Flame test method (DIN EN 60695-11-10) | V0 |
| Oxygen index (DIN EN ISO 4589-2) | >32 % |
| NF F16-101, NF F10-102 Class I | 2 |
| NF F16-101, NF F10-102 Class F | 2 |
| Surface flammability NFPA 130 (ASTM E 162) | passed |
| Specific optical density of smoke NFPA 130 (ASTM E 662) | passed |
| Smoke gas toxicity NFPA 130 (SMP 800C) | passed |
| Calorimetric heat release NFPA 130 (ASTM E 1354) | 28 MJ/kg |
| Fire protection for rail vehicles (DIN EN 45545-2) R22 | HL 1 - HL 3 |
| Fire protection for rail vehicles (DIN EN 45545-2) R23 | HL 1 - HL 3 |
| Fire protection for rail vehicles (DIN EN 45545-2) R24 | HL 1 - HL 3 |
| Fire protection for rail vehicles (DIN EN 45545-2) R26 | HL 1 - HL 3 |

Dimensions

| | |
|--------|---------|
| Width | 12.4 mm |
| Length | 21 mm |
| Height | 42.3 mm |
| | 24 mm |
| Pitch | 6.2 mm |

Connection data

Plug - PP-H 4/ 2 - 3212016

Technical data

Connection data

| | |
|---|---------------------------|
| Connection method | Push-in / plug connection |
| Connection in acc. with standard | IEC 61984 |
| Conductor cross section solid min. | 0.2 mm ² |
| Conductor cross section solid max. | 6 mm ² |
| Conductor cross section AWG min. | 24 |
| Conductor cross section AWG max. | 10 |
| Conductor cross section flexible min. | 0.2 mm ² |
| Conductor cross section flexible max. | 4 mm ² |
| Min. AWG conductor cross section, flexible | 24 |
| Max. AWG conductor cross section, flexible | 12 |
| Conductor cross section flexible, with ferrule without plastic sleeve min. | 0.25 mm ² |
| Conductor cross section flexible, with ferrule without plastic sleeve max. | 4 mm ² |
| Conductor cross section flexible, with ferrule with plastic sleeve min. | 0.25 mm ² |
| Conductor cross section flexible, with ferrule with plastic sleeve max. | 4 mm ² |
| 2 conductors with same cross section, stranded, TWIN ferrules with plastic sleeve, min. | 0.5 mm ² |
| 2 conductors with same cross section, stranded, TWIN ferrules with plastic sleeve, max. | 1 mm ² |
| Stripping length | 10 mm ... 12 mm |
| Internal cylindrical gage | A4 |

Standards and Regulations

| | |
|--|-----------|
| Connection in acc. with standard | CUL |
| | IEC 61984 |
| Flammability rating according to UL 94 | V0 |

Drawings

Circuit diagram



Diagram

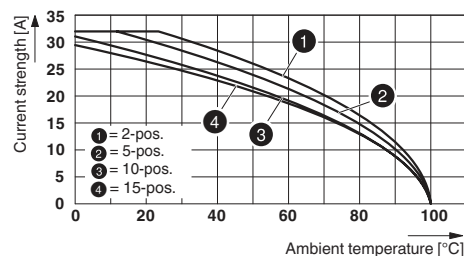

Plug - PP-H 4/ 2 - 3212016

Schematic diagram

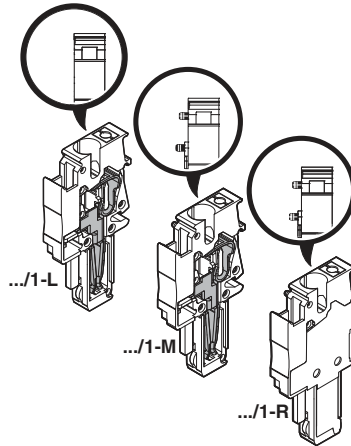

Classifications

eCl@ss

| | |
|------------|----------|
| eCl@ss 4.0 | 272607xx |
| eCl@ss 4.1 | 27260701 |
| eCl@ss 5.0 | 27260701 |
| eCl@ss 5.1 | 27260701 |
| eCl@ss 6.0 | 27141151 |
| eCl@ss 7.0 | 27141151 |
| eCl@ss 8.0 | 27141151 |
| eCl@ss 9.0 | 27141151 |

ETIM

| | |
|----------|----------|
| ETIM 4.0 | EC002021 |
| ETIM 5.0 | EC002021 |

UNSPSC

| | |
|---------------|----------|
| UNSPSC 6.01 | 30211802 |
| UNSPSC 7.0901 | 39121402 |
| UNSPSC 11 | 39121402 |
| UNSPSC 12.01 | 39121402 |
| UNSPSC 13.2 | 39121402 |

Approvals

Approvals

Plug - PP-H 4/ 2 - 3212016

Approvals

Approvals

UL Recognized / cUL Recognized / LR / EAC / BV / DNV GL / cULus Recognized

Ex Approvals

Approval details

UL Recognized <http://database.ul.com/cgi-bin/XYV/template/LISEXT/1FRAME/index.htm> FILE E 60425

| | B | C |
|--------------------------------|-------|-------|
| mm ² /AWG/kcmil | 24-10 | 24-10 |
| Nominal current I _N | 28 A | 28 A |
| Nominal voltage U _N | 600 V | 600 V |

cUL Recognized <http://database.ul.com/cgi-bin/XYV/template/LISEXT/1FRAME/index.htm> FILE E 60425

| | B | C |
|--------------------------------|-------|-------|
| mm ² /AWG/kcmil | 24-10 | 24-10 |
| Nominal current I _N | 28 A | 28 A |
| Nominal voltage U _N | 600 V | 600 V |

LR <http://www.lr.org/en/14/20057>

EAC 7500651.22.01.00246

BV http://www.veristar.com/wps/portal!ut/p/_s.7_0_A/7_0_RIM/39979/A0 BV

DNV GL <https://www.dnvgl.com/TAE000010T>

cULus Recognized <http://database.ul.com/cgi-bin/XYV/template/LISEXT/1FRAME/index.htm>

Plug - PP-H 4/ 2 - 3212016

Accessories

Accessories

Cable housing

Cable housing - PH 4/2 - 3000734



Cable housing, Pitch: 6.2 mm, Length: 21 mm, Width: 12.4 mm, Height: 52.3 mm, Number of positions: 2, Color: gray

Cable housing - PH 4/3 - 3000736



Cable housing, Pitch: 6.2 mm, Length: 21 mm, Width: 18.6 mm, Height: 52.3 mm, Number of positions: 3, Color: gray

Cable housing - PH 4/4 - 3000737



Cable housing, Pitch: 6.2 mm, Length: 21 mm, Width: 24.8 mm, Height: 52.3 mm, Number of positions: 4, Color: gray

Cable housing - PH 4/5 - 3000738



Cable housing, Pitch: 6.2 mm, Length: 21 mm, Width: 31 mm, Height: 52.3 mm, Number of positions: 5, Color: gray

Cable housing - PH 4/6 - 3000739



Cable housing, Pitch: 6.2 mm, Length: 21 mm, Width: 37.2 mm, Height: 52.3 mm, Number of positions: 6, Color: gray

Plug - PP-H 4/ 2 - 3212016

Accessories

Cable housing - PH 4/7 - 3000740



Cable housing, Pitch: 6.2 mm, Length: 21 mm, Width: 43.4 mm, Height: 52.3 mm, Number of positions: 7, Color: gray

Cable housing - PH 4/8 - 3000741



Cable housing, Pitch: 6.2 mm, Length: 21 mm, Width: 49.6 mm, Height: 52.3 mm, Number of positions: 8, Color: gray

Cable housing - PH 4/9 - 3000742



Cable housing, Pitch: 6.2 mm, Length: 21 mm, Width: 55.8 mm, Height: 52.3 mm, Number of positions: 9, Color: gray

Cable housing - PH 4/10 - 3000743



Cable housing, Pitch: 6.2 mm, Length: 21 mm, Width: 62 mm, Height: 52.3 mm, Number of positions: 10, Color: gray

Insulating sleeve

Insulating sleeve - MPS-IH WH - 0201663



Insulating sleeve, Color: white

Plug - PP-H 4/ 2 - 3212016

Accessories

Insulating sleeve - MPS-IH RD - 0201676



Insulating sleeve, Color: red

Insulating sleeve - MPS-IH BU - 0201689



Insulating sleeve, Color: blue

Insulating sleeve - MPS-IH YE - 0201692



Insulating sleeve, Color: yellow

Insulating sleeve - MPS-IH GN - 0201702



Insulating sleeve, Color: green

Insulating sleeve - MPS-IH GY - 0201728



Insulating sleeve, Color: gray

Plug - PP-H 4/ 2 - 3212016

Accessories

Insulating sleeve - MPS-IH BK - 0201731



Insulating sleeve, Color: black

Insulating sleeve - ISH 4/0,5 - 3002885



Insulating sleeve, Color: gray

Insulating sleeve - ISH 4/1,0 - 3002898



Insulating sleeve, Color: black

Labeled terminal marker

Zack Marker strip, flat - ZBF 6 CUS - 0825027



Zack Marker strip, flat, Strip, can be ordered: Strip, white, labeled according to customer specifications, Mounting type: Snap into flat marker groove, for terminal block width: 6.2 mm, Lettering field: 5.15 x 6.15 mm

Marker for terminal blocks - UC-TMF 6 CUS - 0824646



Marker for terminal blocks, can be ordered: by sheet, white, labeled according to customer specifications, Mounting type: Snap into flat marker groove, for terminal block width: 6.2 mm, Lettering field: 5.6 x 5.1 mm

Plug - PP-H 4/ 2 - 3212016

Accessories

Marker for terminal blocks - UCT-TMF 6 CUS - 0829665



Marker for terminal blocks, can be ordered: by sheet, white, labeled according to customer specifications, Mounting type: Snap into flat marker groove, for terminal block width: 6.2 mm, Lettering field: 5.4 x 4.7 mm

Zack Marker strip, flat - ZBF 6,LGS:FORTL.ZAHLEN - 0808749



Zack Marker strip, flat, Strip, white, labeled, Printed horizontally: Consecutive numbers 1 - 10, 11 - 20, etc. up to 91 - 100, Mounting type: Snap into flat marker groove, for terminal block width: 6.2 mm, Lettering field: 5.15 x 6.15 mm

Zack Marker strip, flat - ZBF 6,QR:FORTL.ZAHLEN - 0808765



Zack Marker strip, flat, Strip, white, labeled, Printed vertically: Consecutive numbers 1 - 10, 11 - 20, etc. up to 91 - 100, Mounting type: Snap into flat marker groove, for terminal block width: 6.2 mm, Lettering field: 5.15 x 6.15 mm

Zack Marker strip, flat - ZBF 6,LGS:GERADE ZAHLEN - 0810834



Zack Marker strip, flat, Strip, white, labeled, Printed horizontally: Consecutive numbers 2 - 20, 22 - 40, etc. up to 82 - 100, Mounting type: Snap into flat marker groove, for terminal block width: 6.2 mm, Lettering field: 5.15 x 6.15 mm

Zack Marker strip, flat - ZBF 6,LGS:UNGERADE ZAHLEN - 0810876



Zack Marker strip, flat, Strip, white, labeled, Printed horizontally: Odd numbers 1 - 19, 21 - 39, etc. up to 81 - 99, Mounting type: Snap into flat marker groove, for terminal block width: 6.2 mm, Lettering field: 5.15 x 6.15 mm

Mounting material

Plug - PP-H 4/ 2 - 3212016

Accessories

Latching - PR/2 - 3040630



Latching, Number of positions: 2, Color: orange

Latching - PRT/2 - 3040631



Latching, can only be released using a screwdriver, Number of positions: 2, Color: orange

Latching - PRZ - 3040614



Latching, Length: 3 mm, Width: 5.2 mm, Number of positions: 2, Color: orange

Latching - PR - 3040559



Latching, Number of positions: 1, Color: orange

Screwdriver tools

Screwdriver - SZF 1-0,6X3,5 - 1204517



Actuation tool, for ST terminal blocks, also suitable for use as a bladed screwdriver, size: 0.6 x 3.5 x 100 mm, 2-component grip, with non-slip grip

Plug - PP-H 4/ 2 - 3212016

Accessories

Screwdriver - ST-BW - 1207608



Actuation tool, for all 2.5 mm² - 4.0 mm² spring-cages

Shield connection

Shield connection clip - PSH 3- 6 - 3040591



Shield connection clip, Color: black

Shield connection clip - PSH 5-10 - 3040601



Shield connection clip, Color: black

Terminal marking

Zack Marker strip, flat - ZBF 6:UNBEDRUCKT - 0808710



Zack Marker strip, flat, Strip, white, unlabeled, can be labeled with: Plotter, Mounting type: Snap into flat marker groove, for terminal block width: 6.2 mm, Lettering field: 5.15 x 6.15 mm

Marker for terminal blocks - UC-TMF 6 - 0818140



Marker for terminal blocks, Sheet, white, unlabeled, can be labeled with: BLUEMARK CLED, BLUEMARK LED, Plotter, Mounting type: Snap into flat marker groove, for terminal block width: 6.2 mm, Lettering field: 5.6 x 5.1 mm

Plug - PP-H 4/ 2 - 3212016

Accessories

Marker for terminal blocks - UCT-TMF 6 - 0828746



Marker for terminal blocks, Sheet, white, unlabeled, can be labeled with: THERMOMARK CARD, BLUEMARK CLED, BLUEMARK LED, TOPMARK LASER, THERMOMARK PRIME, Mounting type: Snap into flat marker groove, for terminal block width: 6.2 mm, Lettering field: 5.4 x 4.7 mm

Test plug terminal block

Test plugs - MPS-MT - 0201744



Test plugs, Color: silver