

# I/O Relay Terminal G7TC

CSM\_G7TC\_DS\_E\_6\_1

## Single Cable Connection to PLC Means Space is Saved and Less Control Panel Wiring is Required.

- Compact size: 182 (W) × 85 (D) × 68 (H) mm (8-point Output Block width is 102 mm).
- Connects to the PLC through the connector, and requires only a snap-in operation.
- Surge suppressor circuit built-in.
- Immediate recognition of I/O signal status using LED operation indicators.
- Mounts easily on a DIN track.
- G3TA I/O Solid-state relay can be mounted instead of G7T.
- Approved by UL, CSA (except for G7TC-OC16-1).

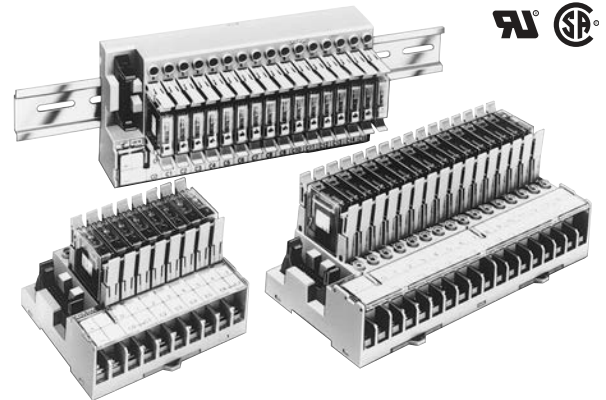

For the most recent information on models that have been certified for safety standards, refer to your OMRON website.

## Ordering Information

I/O Relay Terminal When your order, specify the rated voltage.

I/O classification	I/O points	Internal I/O common	Rated voltage	Model
Input	16	NPN (– common)	12 VDC	G7TC-ID16
			24 VDC	
			100 (110) VDC	
			100/(110) VAC	G7TC-IA16
			200/(220) VAC	
Output	16	NPN (+ common)	12 VDC	G7TC-OC16
			24 VDC	
		PNP (– common)	12 VDC	G7TC-OC16-1 *
			24 VDC	
	8	NPN (+ common)	12 VDC	G7TC-OC08
			24 VDC	
			24 VDC	

**Note: 1.** When ordering, add the rated coil voltage to the model number.  
Example: G7TC-ID16 24 VDC

Rated coil voltage

**2.** When the G7TC is used with an AC rated voltage, three rated currents can be used. If a coil voltage of 110 or 220 VAC is used, 50 Hz cannot be used.

\* Not approved by UL, CSA.

## Accessories (Order Separately)

### Cable for I/O Relay Terminals XW2Z-R

- Cable with Loose Wire and Crimp Terminals: XW2Z-RY□□C  
XW2Z-RA□□C
- Cable with Loose Wires:
- Cable with connectors
  - Fujitsu connectors (1:1): XW2Z-R□□C
  - (1:2): XW2Z-RI□□C-□  
XW2Z-RO□□C-□
  - (1:3): XW2Z-R□□C-□-□
  - MIL connectors (1:1): XW2Z-RI□□C  
XW2Z-RO□□C
  - (1:2): XW2Z-RI□□-□-□D□  
XW2Z-RM□□-□-□D□  
XW2Z-RO□□-□-□D1

Refer to *Connecting Cables* on page 14 for details.

### Short Bar

Model
G78-04

### Output Short-Circuit Module

Model
G77-S

### Socket

Model
P7TF-05

### Mounted Relays and I/O Terminal Sockets

Mounted Relays (G7T I/O Relays and G3TA I/O SSRs)

I/O Terminal Sockets (P7TF-IS16/OS16/OS08)



Refer to *Safety Precautions* on page 13 for details.

### Indicator Module (With Surge Suppressing Function)

	Model	Applicable relay coil voltage	Remarks
For AC relay	P70A	100 (110) V AC	Varistor surge suppression
		200 (220) V AC	
For DC relay	P70D	12/24 V DC	Diode surge suppression

**Note:** 1. Order the indicator module suitable for the relay coil voltage.  
 2. The indicator module for DC relays can be used with a 12-V or 24 V DC power supply.

### Accessories for DIN Track Mounting

Appearance	Name	Model	Minimum order (quantity)
	DIN Tracks	1 m	1
		0.5 m	
	End Plate	PFP-M *	10
	Spacer	PFP-S *	

\* Please order in sets of 10 units.

## Model Number Legend

A G7TC I/O Relay Terminal is a combination of (8 or 16) G7T I/O Relays with SPST-NO specifications and a P7TF I/O Terminal Socket.

**G7TC-**      
 1 2 3 4

#### 1. Input/Output Classification

- I: For input
- O: For output

#### 2. Type of I/O Signal

- A: AC coil type for input relays mounted (Input/Output Classification: I)
- D: DC coil type for input relays mounted (Input/Output Classification: I)
- C: Contact output for output relays mounted (Input/Output Classification: O)

#### 3. Number of I/O Points

- 16: 16 points
- 08: 8 points (for output only)

#### 4. Internal I/O Common

Blank: NPN

Output

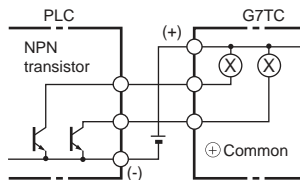

Input

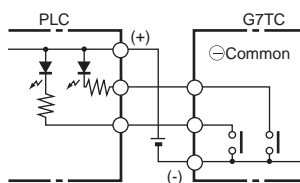

1: PNP

Output

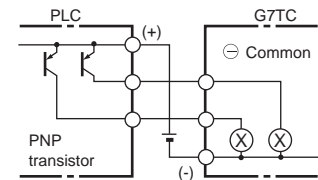

## Specifications

### Coil Ratings (Common to Input/Output per Relay)

Rated voltage (V)	Item	Rated current (mA)		Coil resistance (Ω)	Must operate	Must release	Maximum voltage	Power consumption	
		50 Hz	60 Hz					of rated voltage	
AC	100/(110)	8.2/-	7/7.7	8,700	80% max.	30% min.	105%	0.7 VA	11 VA
	200/(220)	4.1/-	3.5/3.85	33,300					
DC	12	42		290	80% max.	10% min.	105%	0.5 W	8 W
	24	21		1,150					
	100/110	5		20,000					

- Note:**
1. The rated current and coil resistance are measured at a coil temperature of 23°C with a tolerance of 15%/-20% for AC rated current and ±15% for coil resistance.
  2. The operating characteristics are measured at a coil temperature of 23°C.
  3. The value for maximum voltage is the maximum value within the allowable voltage fluctuation range for the relay coil's operating power supply. Continuous operation at this voltage is not within product specifications.
  4. Approx. 4 mA flows into each LED indicator. To calculate the power supply capacity, add the current value of each LED indicator.
  5. When the G7TC is used with an AC rated voltage, three rated currents can be used. If a coil voltage of 110 or 220 VAC is used, 50 Hz cannot be used.

### Contact Ratings (G7T I/O Relay)

Classification	For input		For output	
	Resistive load (cosφ=1)	Inductive load (cosφ=0.4 L/R=7 ms)	Resistive load (cosφ=1)	Inductive load (cosφ=0.4 L/R=7 ms)
Rated load	1 A at 24 VDC	0.5 A at 24 VDC	2 A at 220 VAC 5 A at 24 VDC	1 A at 220 VAC 2 A at 24 VDC
Rated carry current	1 A		5 A	
Max. switching voltage	250 VAC, 125 VDC			
Max. switching current	1 A	0.5 A	5 A	2 A
Error rate (reference value) *	100 μA at 1 V		10 mA at 5 V	
Electrical endurance	10,000,000 operations (at 10 mA) 50,000 operations (at 1 A)	2,500,000 operations (at 10 mA) 20,000 operations (at 1 A)	1,000,000 operations (under rated load)	
Mechanical endurance	50,000,000 operations			

\* The above values are for a switching frequency of 120 operations/min.

## Characteristics

Item	Model	G7TC-IA16 (Input, AC coil)	G7TC-ID16 (Input, DC coil)	G7TC-OC16 (-1) (output, DC coil)	G7TC-OC08 (output, DC coil)
Contact form		SPST-NO × 16			SPST-NO × 8
Contact mechanism		Bifurcated crossbar contact		Single contact	
Contact material		Au cladding + Ag		AgInSn	
Contact resistance #1		50 mΩ max.			
Must Operate time #2		15 ms max.			
Release time #2		15 ms max.			
Max. switching frequency	Mechanical limit	18,000 operations/h			
	At rated load	1,800 operations/h			
Insulation resistance		100 MΩ (at 500 VDC)			
Dielectric strength	Between coil and contact	2,000 VAC, 50/60 Hz for 1 minute			
	Between same polarity contacts	1,000 VAC, 50/60 Hz for 1 minute			
	Between paired connectors #3	250 VAC, 50/60 Hz for 1 minute			
Vibration resistance		10 to 55 to 10 Hz with 0.5-mm single amplitude (1.0-mm double amplitude)			
Shock resistance		200 m/s <sup>2</sup>			
Noise immunity		Noise level: 1.5 kV; pulse width: 100 ns to 1 μs			
Rated voltage between positive and negative terminal blocks		Rated voltage of controller's (PLC or other) input circuit		12 VDC ±5%	24 VDC ±5%
Rated current between positive and negative terminal blocks		Input circuit current of controller (PLC or other) × number of ON points		12 VDC: 46 mA × number of ON points	24 VDC: 25 mA × number of ON points
Cable length #4	To controller	5 m max. (reference value)			
	To I/O devices	50 m max. (reference value, for 2-mm <sup>2</sup> CVV cable)		Dependent on load	
Ambient operating temperature		0 to 55°C			
Ambient operating humidity		35% to 85% (with no icing or condensation)			
Tightening torque for external connections		0.78 to 1.18 N·m			
Tensile strength		No damage when a tensile force of 49 N is applied in each direction. In the direction of the track, the tensile strength is 9.8 N min.			
I/O terminal tightening torque		Tightening strength: 0.98 N·m; Tensile strength 49 N per minute			
LED color		Red	Green		
Case color		Transparent red	Transparent green	Transparent green	
Coil surge absorber		Varistor	Diode (1 A, 1,000 V)		
Weight		Approx. 640 g	Approx. 630 g	Approx. 670 g	Approx. 350 g

**Note:** The above values are initial values.

\*1. Measurement: 1 A at 5 VDC.

\*2. Ambient temperature: 23°C.

\*3. This is between connector pin No. 10 and 20, and between connector pin No. 9 and 19.

\*4. Connecting cables up to 5 m are available as standard products. For longer cables, enquire separately.

## Approved Standards

- The rated values for safety standard certification are not the same as individually defined performance values. Always check the specifications before use.
- Standard G7TC I/O Relay Terminal, except for the G7TC-OC16-1, have met UL and CSA standards (UL file no. E95399; CSA file no. LR35535).

### UL standard certification (File No. E95399)

Model	Standard number	Category	Listed/Recognized	Contact ratings
G7TC-ID16 G7TC-IA16	UL508	NRAQ2	Recognized	Terminal block side: 250 VAC max./point Connector side: 10 mA/point, 24 VDC
G7TC-OC16 G7TC-OC08	UL508	NRAQ2	Recognized	Terminal block side: Inductive load: 10 A, 250 VAC Resistive load: 10 A, 30 VDC Rated horsepower: 1/2 HP, 240 VAC

### CSA Standard (File No. LR35535)

Model	Standard number	Class number	Contact ratings
G7TC-ID16	CSA C22.2 No.14	3211 04	6 to 240 VAC 6 to 125 VDC
G7TC-IA16			
G7TC-OC16			
G7TC-OC08			

# Engineering Data (Reference Value)

## Life Expectancy of Output

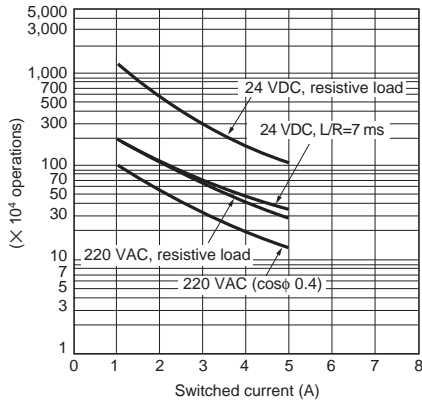

## Max. Switching capacity of Output

(Life expectancy: 1,000,000 operations)

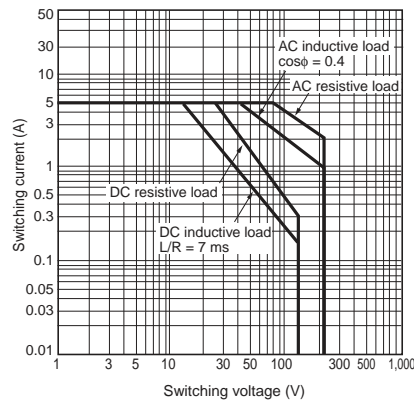

## Life Expectancy of Input

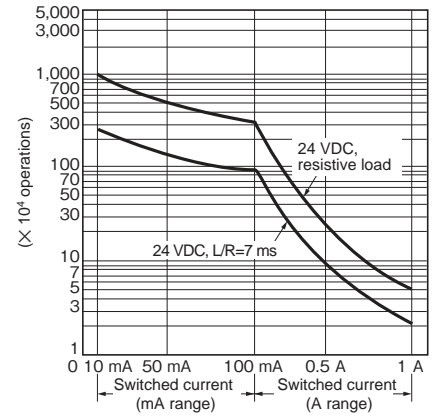

- Note:**
- These data are actual measured values that were sampled from the production line and prepared in graph format, and are for reference purposes only. A relay is manufactured by mass production, and as a basic rule must be used with allowance made for a certain amount of deviation.
  - The data shown above are values for a single relay.

## Load Current vs. Ambient Temperature

G3TA-OA202SZ-US  
G3TA-OA202SL-US  
G3TA-ODX02S-US

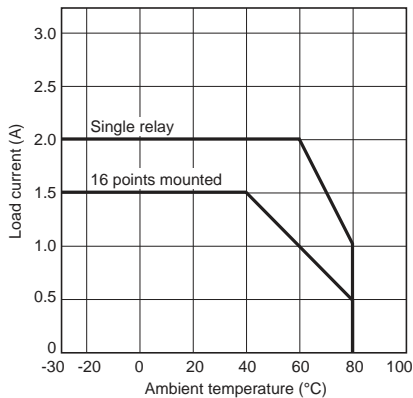

G3TA-OA201S-US

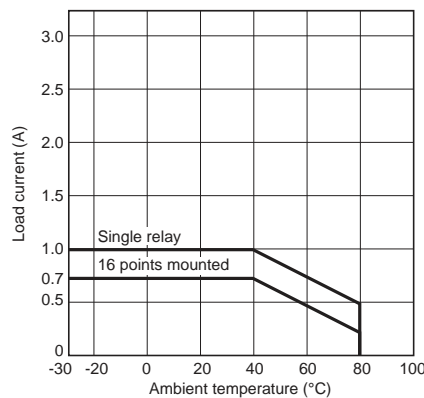

## Inrush Current

The following graphs show the maximum inrush currents that can be withstood for non-repetitive operation. For repetitive operation, the figures should be reduced by half.

G3TA-OA202SZ-US  
G3TA-OA202SL-US

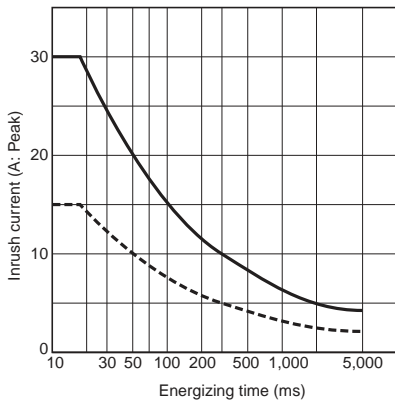

G3TA-ODX02S-US  
G3TA-OD201S-US

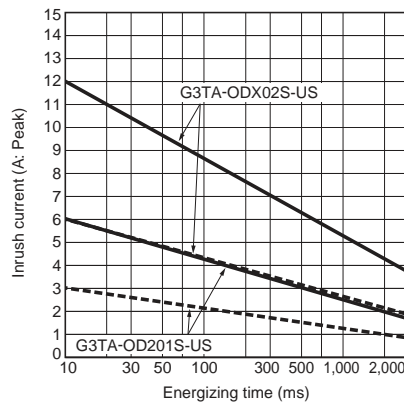

### Cable Length

The following graph gives reference values for the relationship between cable length and voltage in the case where the voltage fluctuation of the power supply is 5%.

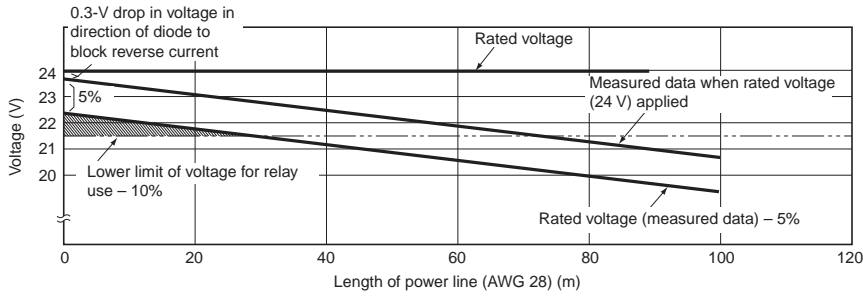

### Internal Circuits

#### G7TC-ID16 (NPN input/- common)

##### Connector Pin Configuration Top View

I/O indications on Screw Terminals

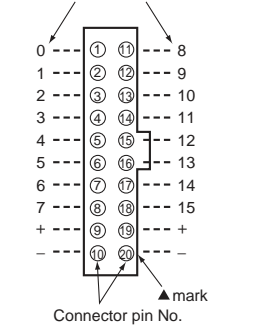

Connector pin No.

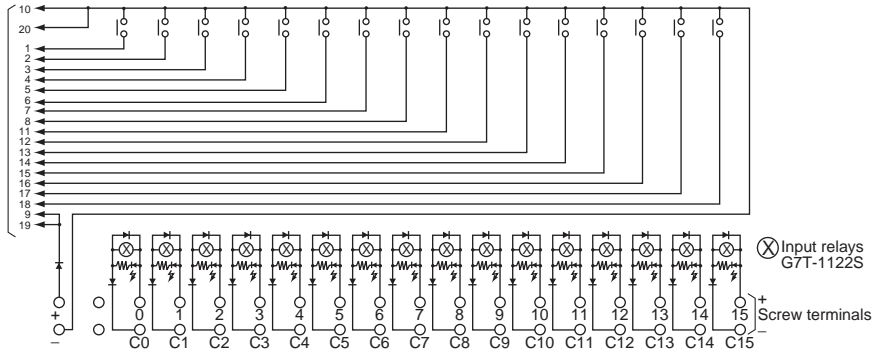

#### G7TC-IA16 (NPN input/- common)

##### Connector Pin Configuration Top View

I/O indications on Screw Terminals

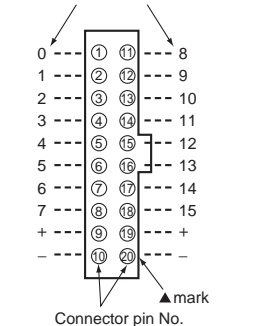

Connector pin No.

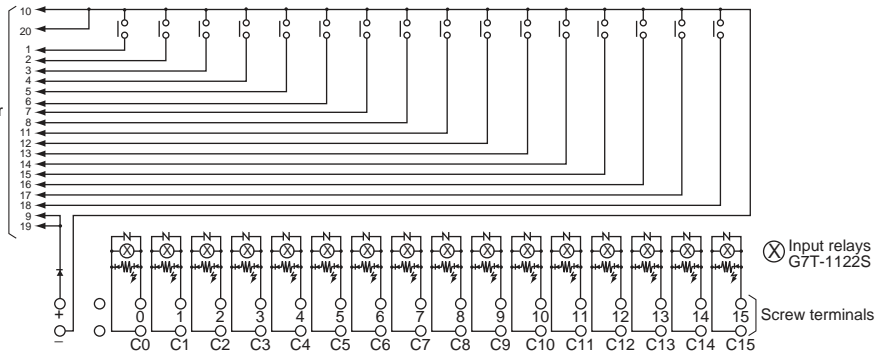

**Note:** Pin numbers are indicated for convenience. The ▲ mark can be used to determine orientation.

**G7TC-OC16 (NPN output/+ common)**

**Note:** A controller with an NPN transistor, common output can be connected to the G7TC-OC16.

**Connector Pin Configuration  
Top View**

I/O indications on Screw Terminals

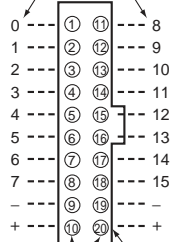

Connector No.

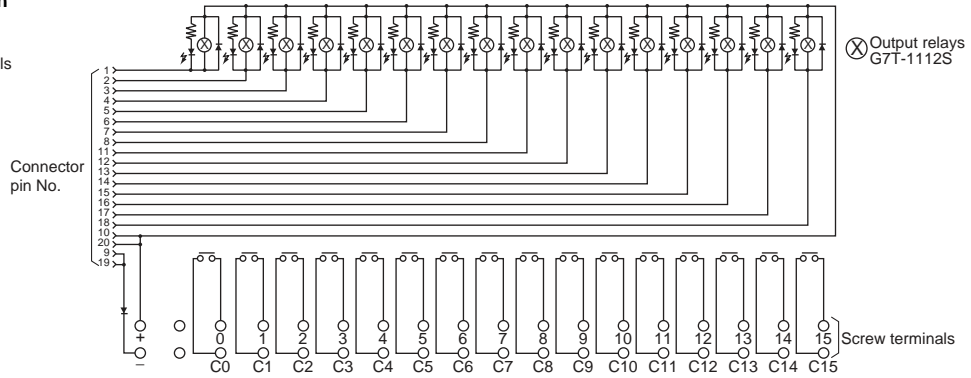

**G7TC-OC16-1 (PNP output/- common)**

**Note:** A controller with a PNP transistor, + common output can be connected to the G7TC-OC16-1.

Do not connect the G71 Remote Interface to the G7TC-OC16-1.

Due to the difference in polarity, the G71 will be damaged if the G7TC-OC16-1 and the G71 are connected to each other.

Use the G7TC-OC16 (NPN output/+ common) instead, to connect to the G71.

The reception of orders for G71 Remote Interface was discontinued at the end of March 2012.

**Connector Pin Configuration  
Top View**

I/O indications on Screw Terminals

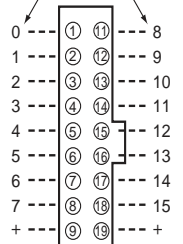

Connector No.

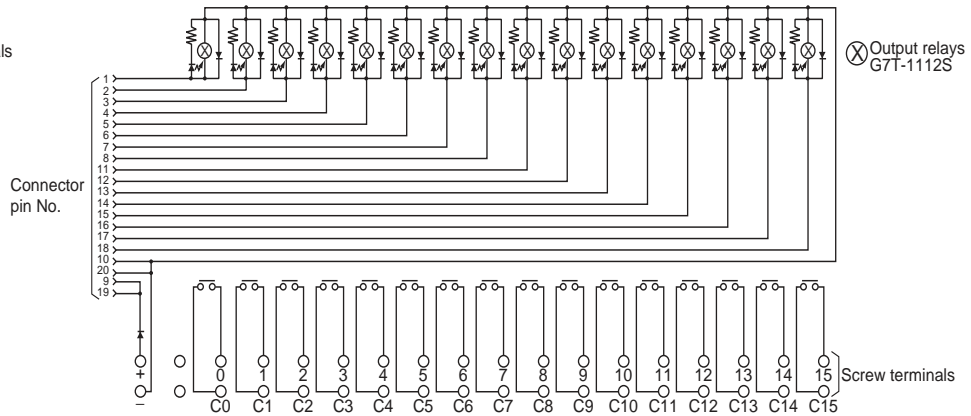

**G7TC-OC08 (NPN output/+ common)**

**Note:** A controller with an NPN transistor, -common output can be connected to the G7TC-OC08.

**Connector Pin Configuration  
Top View**

I/O indications on Screw Terminals

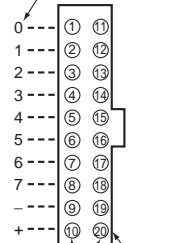

Connector No.

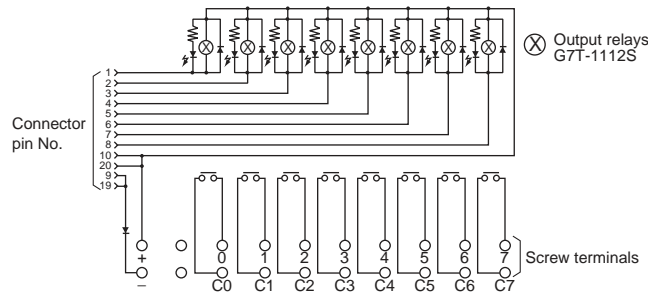

**Note:** Pin numbers are indicated for convenience. The ▲ mark can be used to determine orientation.

# Dimensions

## I/O Relay Terminal

G7TC-ID16  
G7TC-IA16

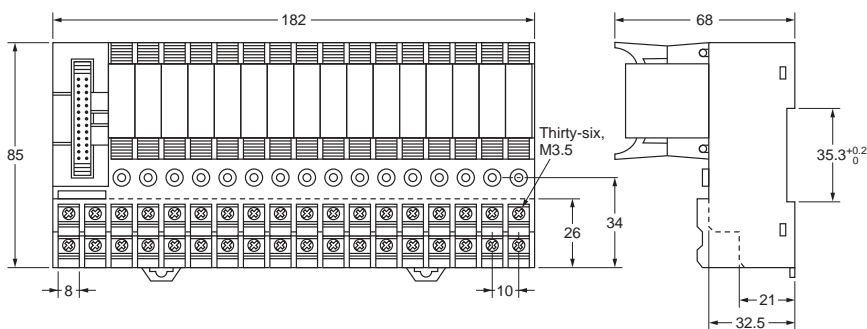
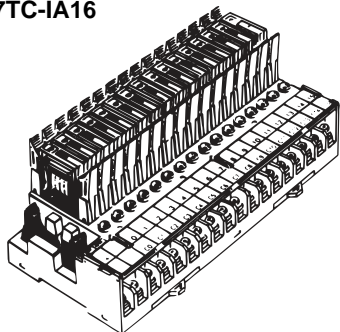

G7TC-OC16  
G7TC-OC16-1

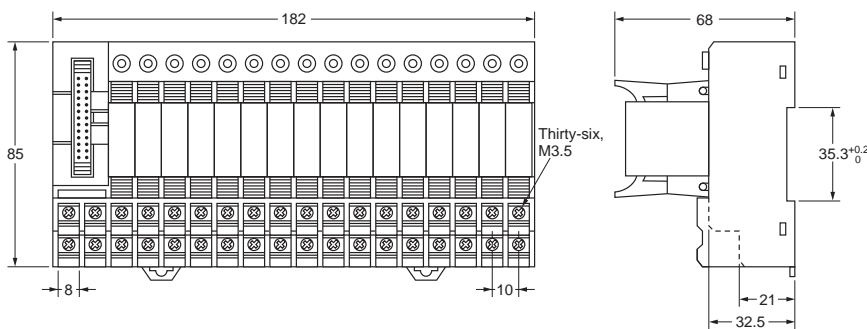
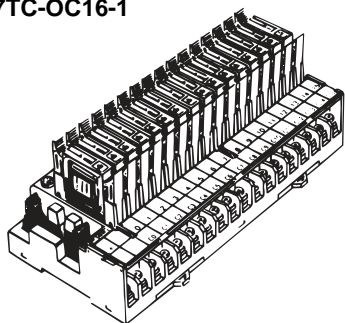

G7TC-OC08

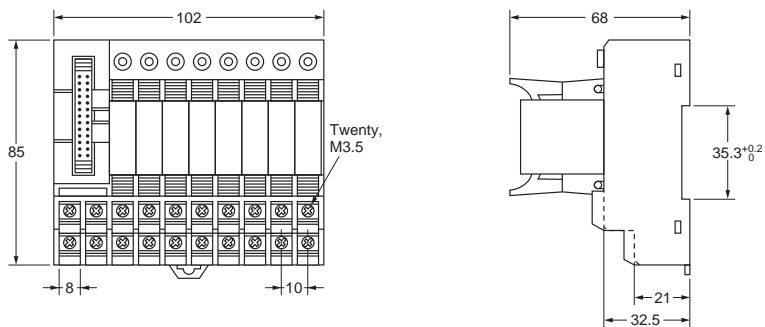
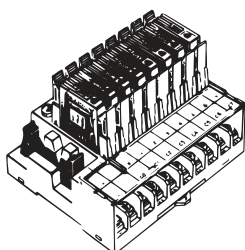



## Accessories (Order Separately)

### Short Bar

#### G78-04

Use this piece for short-circuiting across terminals.  
Max. current flow: 20 A

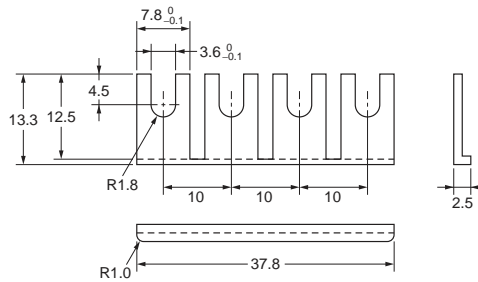
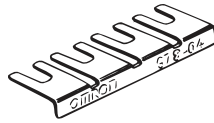

### Output Short-Circuit Module

#### G77-S

The output of the I/O Relay Terminal can be obtained without relays through the G77-S Output Short-Circuit Module. Note that the G77-S Output Short-Circuit Module is not available for inputs.

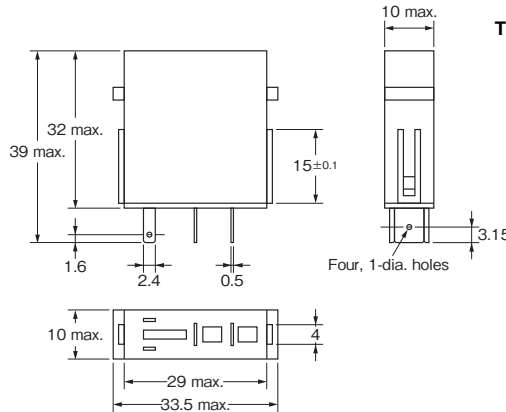
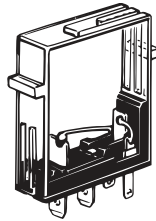

Terminal Arrangement/Internal Connections (Bottom View)

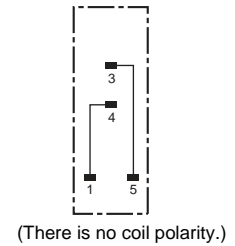

### Socket

#### P7TF-05

The G7T (SPST-NO, SPST-NC, and SPDT types) and the G3TA I/O Relays can be mounted on the P7TF-05 Socket. The P7TF-05 can be used for applications involving sequences that require slim relays, or to enable use of SPDT relays with the I/O Relay Terminal. To use part of the I/O Relay Terminal with SPDT specifications, insert an Output Short-Circuit Module into the I/O Relay Terminal, and use the P7TF-05 Socket in combination with an SPDT Relay for the Module's output.

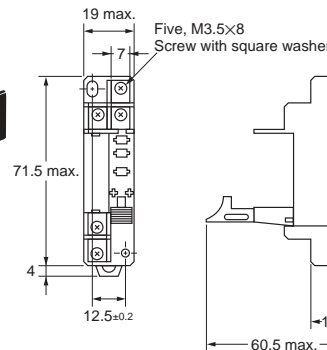
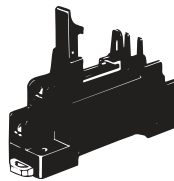

Internal Connections (Top View)

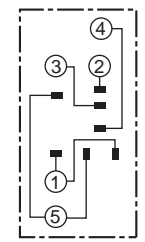

**Note:** Terminal 1 is positive when the I/O SSR is employed.

### Specifications

<b>Contact resistance</b>	10 mΩ max. (measured at 5 V DC, 1 A)
<b>Dielectric strength</b>	2,000 VAC for 1 minute
<b>Insulation resistance</b>	1,000 MΩ min. (at 500 V)
<b>Vibration resistance</b>	10 to 55 to 10 Hz, 0.5 mm single amplitude (1.0 mm double amplitude)
<b>Shock resistance</b>	1,000 m/s <sup>2</sup>
<b>Ambient temperature</b>	Operating: -40 to 70°C (with no icing or condensation)
<b>Ambient humidity</b>	5% to 85%
<b>Weight</b>	Approx. 28 g

Mounting Hole Dimensions

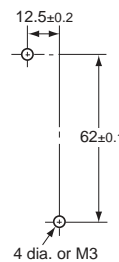

**Note:** Terminal 1 is positive when the G3TA or Indicator Module is employed.

### Indicator Module (With Surge Suppressing Function)

#### P70□

Remove the transparent style strip of the P7TF-05 socket and mount this module and it will function as an operation indicator with the surge suppression.

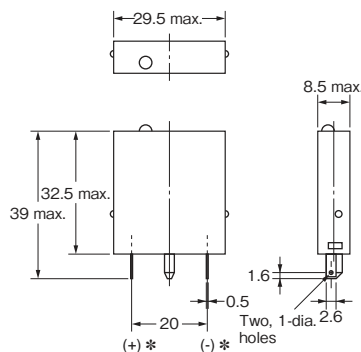

Internal Connection

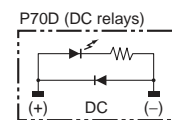
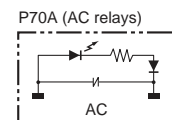

(There is no coil polarity for AC relays.)

\* For DC relays

Parts for Rail Mounting

DIN Track  
PFP-100N  
PFP-50N

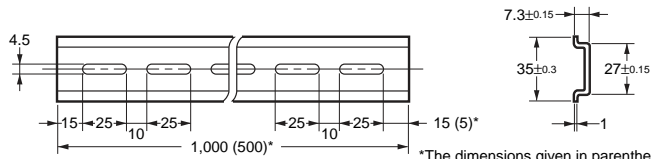
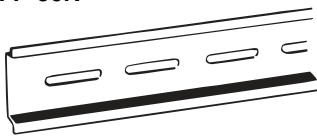

\*The dimensions given in parentheses ( ) are for the PFP-50N.

End Plate  
PFP-M

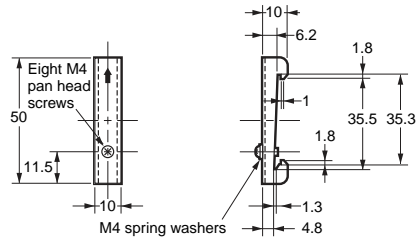
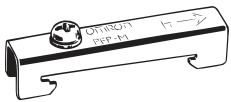

Spacer  
PFP-S

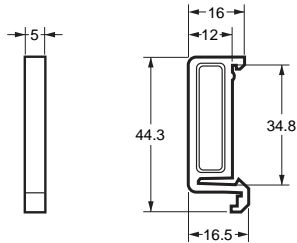
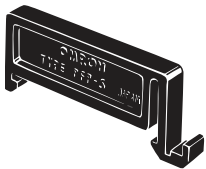

# Terminal Arrangement / Terminal Connection Example

## Input G7TC-ID16 G7TC-IA16

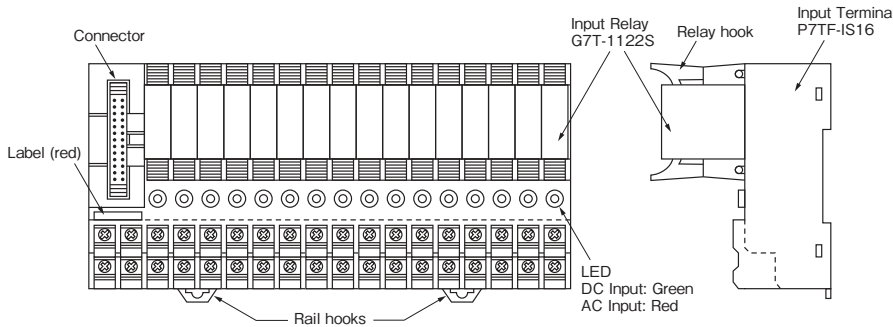

- Supply power to terminals 0 through 15 and C0 through C15 according to the voltage specifications of the I/O Relays and I/O Relay Terminal. Do not reverse positive and negative terminals on the DC Input Block (0 through 15 are positive; C0 through C15, negative). Short Bar is available.
- Supply to the power terminal (positive and negative) the rated voltage of the controller's input circuits (24 VDC or 12 VDC). Use a low-noise power source.
- When using a Connecting Cable with two connectors, be sure to use the Cable for Input Blocks. Using the Cable for Output Blocks may result in malfunction or damage to the product. Connecting Cable: XW2Z-R Tape Color: Red

### External connections

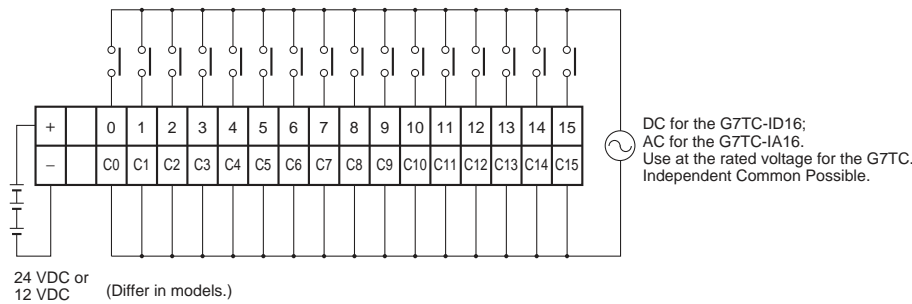

## Output G7TC-OC16(-1) G7TC-OC08

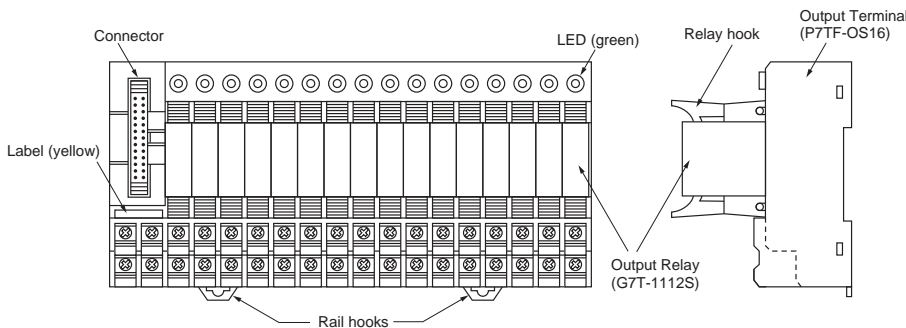

- There are voltage specifications for the Relays and Terminals. Depending on the controller connected, select either 12 or 24 VDC.
- Supply power to contact output terminals 0 through 15 and C0 through C15 according to the requirements of the loads. A 4 terminal Short Bar is available.
- Supply to the power terminals (positive and negative) power both for driving the relays and for controller output transistors. Match the controller and I/O Relay Terminal voltage specifications. Use a low- noise power source.
- When using a Connecting Cable with two connectors, be sure to use the Cable for Output Blocks. Using the Cable for Input Blocks may result in malfunction or damage to the product. Connecting Cable: XW2Z-R Tape Color: Yellow
- Output Block Unit G7TC-OC08 does not have terminals 8 through 15 and C8 through C15. Although a 20-pin connector is used, pins 11 through 18 are not connected.
- When an I/O SSR (G3TA-OD□□-US) is mounted, terminals 0 to 15 will be positive.

### External connections

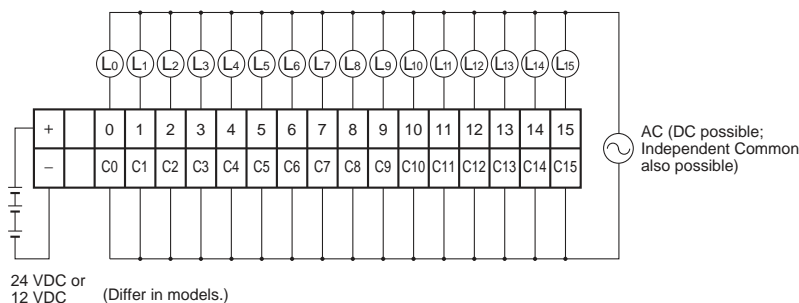

## Connection Example for SPDT Relays

The following is an application example for the P7TF-05 using an SPDT Relay on a terminal of the G7TC-□□16(-1).

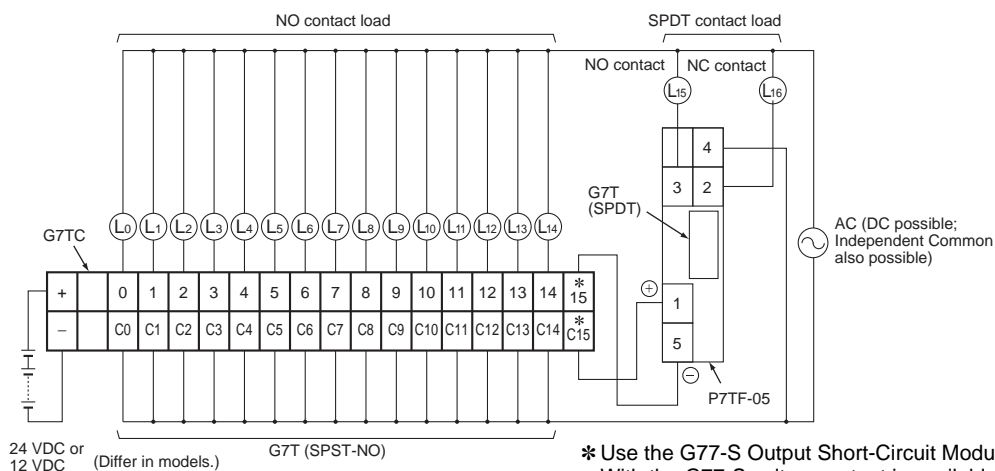

\* Use the G77-S Output Short-Circuit Module in place of the G7T I/O Relay. With the G77-S voltage output is available between terminals 15 and C15. The maximum current is determined according to the controller.

**Note:** If more than one G77-S Output Short-Circuit Module is employed, the voltage output of the terminals on the G7TC is as follows:  
 G7TC-OC16: The positive side (the lower row) connects to the common line internally.  
 G7TC-OC16-1: The negative side (the upper row) connects to the common line internally.

## Safety Precautions

Be sure to read *The Safety Precautions for All I/O Relay Terminals* in the website at the following URL: <http://www.ia.omron.com/product/cautions/46/243/index.html>.

For PLC I/O unit connection procedures, refer to *G70V/G7TC/G70A/G70D Table of I/O Relay Terminal and connectable device combinations* (Cat. No. J217).

### General

I/O Relays and I/O Relay Terminal can be combined as follows to form I/O Relay Terminal:

	I/O Relay Terminal	I/O Relay	I/O SSR #2		I/O Terminal (Socket) #3
DC input	G7TC-ID16	G7T-1122S *1	DC	G3TA-IDZ002 (M)-US	P7TF-IS16 (DC type)
AC input	G7TC-IA16		AC	G3TA-IAZR02S-US	P7TF-IS16 (AC type)
DC output	G7TC-OC16 G7TC-OC16-1 G7TC-OC08	G7T-1112S (SPST-NO type) *1 G7T-1012S (SPST-NC type)	AC	G3TA-OA202SZ-US G3TA-OA202SL-US	P7TF-OS16 P7TF-OS16-1
			DC	G3TA-ODX02S-US G3TA-OD201S-US	P7TF-OS08

\*1. These are the I/O Relays mounted on the G7TC I/O Relay Terminal.

\*2. To use I/O SSRs, remove the I/O Relays and mount the I/O SSRs to the slots where the I/O Relays were mounted. Or, order and combine a P7TF I/O Terminal and I/O SSRs.

\*3. The P7TF I/O Terminal provides only sockets. It does not have Relays mounted to it. Mount I/O Relays or I/O SSRs to the sockets. Specify the rated voltage in the same way as when ordering the G7TC I/O Relay Terminal.

- Combinations of AC Input Relays/SSRs and DC Input Relays/SSRs cannot be used with the same Terminal. This is because specifications for coil surge suppression elements are different. Relays/SSRs with different voltage specifications cannot be used with the same Terminal. (For example, a 100-VAC Input Relay and a 200-VAC Input Relay, or a 12-VDC Output Relay and a 24-VDC Output Relay cannot be used with the same Terminal.) This is because specifications of operation indicator circuits are different.
- Only use I/O Terminals, I/O Relays, and I/O SSRs with the same specifications for rated voltage.
- I/O Relay Terminal are color coded, as shown below, according to input/output and AC/DC specifications.

		I/O Terminal label	I/O Terminal indicators	I/O Relay case
for Input	DC	Red	Green	Green
	AC	Red	Red	Red
for Output	DC	Yellow	Green	Transparent

- Both Input and Output Blocks do not have internal power supplies. For an Output Block, supply the relay drive power to the positive and negative terminals (either 12 or 24 VDC). Loads (terminal contacts 0 through 15) must also be supplied with appropriate power. For an Input Block, supply, to the positive and negative terminals, power for input signals to the controller.
- The same Connecting Cable, XW2Z-RY, is used for the G7TC-OC08 eight-point Output Block as for other I/O Relay Terminal; leave 8 points unconnected.
- Indicators indicate the presence or absence of signals. Use the display lever inside each relay for fault diagnosis. (Some relays do not have this lever depending on the specifications.)
- Each relay must be pressed down until its hold-down hooks engage completely. Heating or malfunction can result if relays are not mounted properly.
- Unlabeled terminals are not electrically connected. Use these for repeater terminals.
- Indicator positions and relay orientation differ between Input and Output Blocks. This is to aid in differentiating Input Blocks from Output Blocks and in following signal flow.
- DC Input Blocks and Output Blocks with G3TA-OD□□□□ have positive and negative terminals, with the positive terminals normally being on the top of the I/O Relay Terminal. Reversing positive and negative terminals will prevent operation.

- DIN tracks are generally used to mount I/O Relay Terminal. For screw mounting, a 210-mm DIN track is available that can be used as an adapter in combination with End Plates (PFP-M, two required).
- A Short Bar is provided to connect four terminals. The current capacity of the Short Bar is 20 A. As long as this current capacity is not exceeded, the Short Bar can be used in combination as shown at the right to connect more than four terminals.

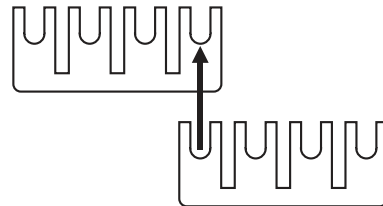

- Special Connecting Cables are provided for connections to OMRON PLC I/O Units with Connectors. Connecting Cables with two connectors, however, come in two types: Cables for Input Blocks (XW2Z-R) and Cables for Output Blocks (XW2Z-R). Be sure to purchase the correct Cable for the application.

### Microload Switching

Input Relays (DC coil type) and I/O SSRs (DC input type) can be mounted onto an Output Block. Doing so enables using controller programming to simultaneously switch on or off two outputs (DPST-NO operation) to switch a SPST-NO load that in turn switches another SPST-NO load. One configuration for this is shown below.

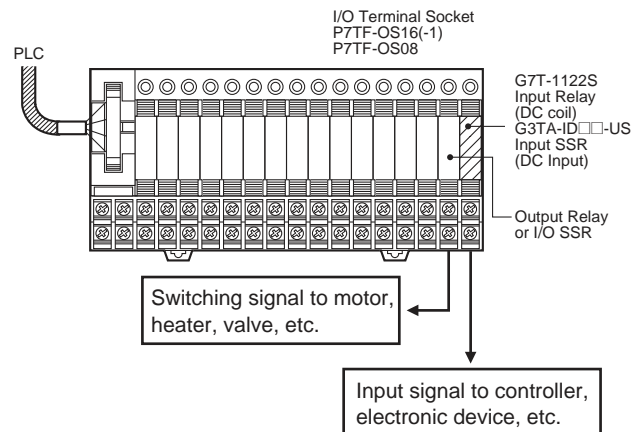

# Connecting Cables

Refer to *XW2Z-R Cables for I/O Relay Terminals* (Cat. No. G126) for details on the Connecting Cables.

Type (A side)	Name	I/O Classification	Appearance	Cable length L (mm)			Models
Various devices	Cables with Loose Wires and Crimp Terminals XW2Z-RY□C	16 I/O points		1,000			XW2Z-RY100C
				1,500			XW2Z-RY150C
				2,000			XW2Z-RY200C
				3,000			XW2Z-RY300C
				5,000			XW2Z-RY500C
	Cables with Loose Wires XW2Z-RA□C	16 I/O points		2,000			XW2Z-RA200C
				5,000			XW2Z-RA500C
Fujitsu connectors (24 pins)	Cables with Connectors (1:1) XW2Z-R□C	16 I/O points		1,000			XW2Z-R100C
				1,500			XW2Z-R150C
				2,000			XW2Z-R200C
				3,000			XW2Z-R300C
				5,000			XW2Z-R500C
Fujitsu connectors (40 pins)	Cables with Connectors (1:2) XW2Z-RI□C-□ XW2Z-RO□C-□	32 input points		(A) 1,000	(B) 750		XW2Z-RI100C-75
				(A) 1,500	(B) 1,250		XW2Z-RI150C-125
				(A) 2,000	(B) 1,750		XW2Z-RI200C-175
				(A) 3,000	(B) 2,750		XW2Z-RI300C-275
				(A) 5,000	(B) 4,750		XW2Z-RI500C-475
		32 output points		(A) 1,000	(B) 750		XW2Z-RO100C-75
				(A) 1,500	(B) 1,250		XW2Z-RO150C-125
				(A) 2,000	(B) 1,750		XW2Z-RO200C-175
				(A) 3,000	(B) 2,750		XW2Z-RO300C-275
				(A) 5,000	(B) 4,750		XW2Z-RO500C-475
Fujitsu connectors (56 pins)	Cables with Connectors (1:3) XW2Z-R□C-□-□	48 I/O points		(A) 1,500	(B) 1,250	(C) 1,000	XW2Z-R150C-125-100
				(A) 2,000	(B) 1,750	(C) 1,500	XW2Z-R200C-175-150
				(A) 3,000	(B) 2,750	(C) 2,500	XW2Z-R300C-275-250
MIL connectors (20 pins)	Cables with Connectors (1:1) XW2Z-RI□C, XW2Z-RO□C	16 I/O points		250			XW2Z-RI25C
				500			XW2Z-RI50C
				250			XW2Z-RO25C
				500			XW2Z-RO50C

Type (A side)	Name	I/O Classification	Appearance	Cable length L (mm)		Models	
MIL connectors (40 pins)	Cables with Connectors (1:2)  XW2Z-RO□-□-D1, XW2Z-RI□-□-D1, XW2Z-RI□-□-D2, XW2Z-RM□-□-D1 *1 XW2Z-RM□-□-D2 *1	32 I/O points		(A) 500	(B) 250	XW2Z-RO50-25-D1	
				(A) 750	(B) 500	XW2Z-RO75-50-D1	
				(A) 1,000	(B) 750	XW2Z-RO100-75-D1	
				(A) 1,500	(B) 1,250	XW2Z-RO150-125-D1	
				(A) 2,000	(B) 1,750	XW2Z-RO200-175-D1	
				(A) 3,000	(B) 2,750	XW2Z-RO300-275-D1	
				(A) 5,000	(B) 4,750	XW2Z-RO500-475-D1	
				(A) 500	(B) 250	XW2Z-RI50-25-D1	
				(A) 750	(B) 500	XW2Z-RI75-50-D1	
		(A) 1,000		(B) 750	XW2Z-RI100-75-D1		
		(A) 1,500		(B) 1,250	XW2Z-RI150-125-D1		
		(A) 2,000		(B) 1,750	XW2Z-RI200-175-D1		
		(A) 3,000		(B) 2,750	XW2Z-RI300-275-D1		
		(A) 5,000		(B) 4,750	XW2Z-RI500-475-D1		
		(A) 500		(B) 250	XW2Z-RI50-25-D2		
		(A) 750		(B) 500	XW2Z-RI75-50-D2		
		16 inputs and 16 outputs (32 I/O points)		(A) 500	(B) 250	XW2Z-RM50-25-D1	
				(A) 750	(B) 500	XW2Z-RM75-50-D1	
(A) 500	(B) 250		XW2Z-RM50-25-D2				
(A) 750	(B) 500		XW2Z-RM75-50-D2				
Mitsubishi Electric PLCs with 32-point connectors (1:2) *2	Mitsubishi Electric PLC Connecting Cables  XW2Z-RI□C-□-MN XW2Z-RO□C-□-MN		32 input points		(A) 1,000	(B) 750	XW2Z-RI100C-75-MN
					(A) 1,500	(B) 1,250	XW2Z-RI150C-125-MN
		(A) 2,000			(B) 1,750	XW2Z-RI200C-175-MN	
		32 output points	(A) 3,000		(B) 2,750	XW2Z-RI300C-275-MN	
			(A) 1,000		(B) 750	XW2Z-RO100C-75-MN	
			(A) 1,500		(B) 1,250	XW2Z-RO150C-125-MN	
(A) 2,000	(B) 1,750	XW2Z-RO200C-175-MN					
(A) 3,000	(B) 2,750	XW2Z-RO300C-275-MN					

**Note: 1.** Contact for a cable length other than the above.

**2.** For a connector pin assignment diagram and cable color information, refer to the wiring drawings.

\*1. These cables are used to connect to slave products for DeviceNet and other networks.

\*2. For details on models that can be used, refer to *List of Combinations with the Mitsubishi PLC MELSEC-L Series, MELSEC-Q Series, and MELSEC iQ-R Series* on page 20.

# Combinations of Connections

Refer to the next page for details on the combinations of cables and connection devices [OMRON PLC I/O Units NX Series, CJ Series, CS Series], [Mitsubishi PLC I/O Units MELSEC-L Series, MELSEC-Q Series, MELSEC IQ-R Series].

For combinations with other products, refer to *I/O Relay Terminals and Connected Devices* (Cat. No. J217) or to the datasheets for related products.

## Connection Patterns

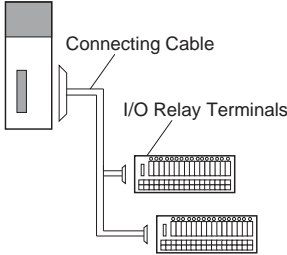
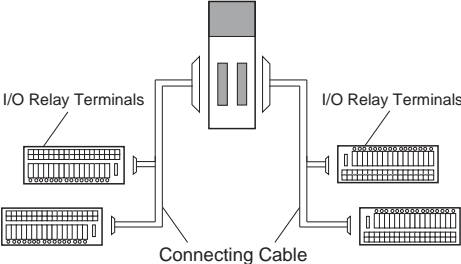
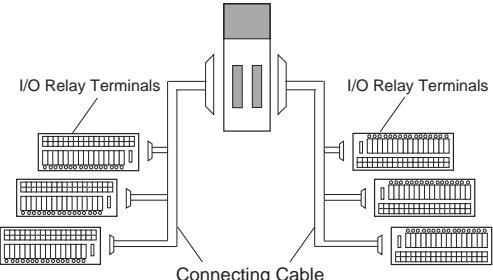
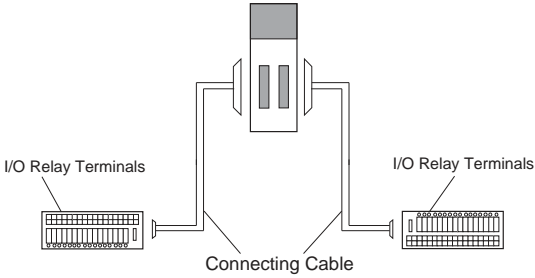
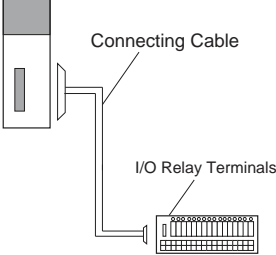
Pattern	Configuration
A	 <p>Connecting Cable</p> <p>I/O Relay Terminals</p>
B	 <p>I/O Relay Terminals</p> <p>I/O Relay Terminals</p> <p>Connecting Cable</p>
D	 <p>I/O Relay Terminals</p> <p>I/O Relay Terminals</p> <p>Connecting Cable</p>
E	 <p>I/O Relay Terminals</p> <p>I/O Relay Terminals</p> <p>Connecting Cable</p>
F	 <p>Connecting Cable</p> <p>I/O Relay Terminals</p>



## List of Combinations with the OMRON PLC NX Series

NX I/O Units				Conne- tion pattern	XW2Z-R Cables			G7TC I/O Relay Terminals		
I/O capacity	Model	External connectors	Polarity		Connection	Model *	Quantity required	Specifications	Model	Quantity required
<b>Input Units</b>										
16 inputs	NX-ID5142-5	1 MIL connector (20 p)	NPN or PNP	F	1:1	XW2Z-RO□C	1	NPN Inputs	G7TC-IA16/ID16	1
32 inputs	NX-ID6142-5	1 MIL connector (40 p)	NPN or PNP	A	1:2	XW2Z-RO□-□-D1	1	NPN Inputs	G7TC-IA16/ID16	2
	NX-ID6142-6	1 MIL connector (40 p)	NPN or PNP		1:2	XW2Z-RI□C-□	1	NPN Inputs	G7TC-IA16/ID16	2
<b>Output Units</b>										
16 outputs	NX-OD5121-5	1 MIL connector (20 p)	NPN	F	1:1	XW2Z-RO□C	1	NPN outputs	G7TC-OC16	1
	NX-OD5256-5	1 MIL connector (20 p)	PNP		1:1	XW2Z-RI□C	1	PNP outputs	G7TC-OC16-1	1
32 outputs	NX-OD6121-5	1 MIL connector (40 p)	NPN	A	1:2	XW2Z-RO□-□-D1	1	NPN outputs	G7TC-OC16	2
	NX-OD6256-5	1 MIL connector (40 p)	PNP		1:2	XW2Z-RI□-□-D1	1	PNP outputs	G7TC-OC16-1	2
32 outputs	NX-OD6121-6	1 Fujitsu connector (40 p)	NPN		1:2	XW2Z-RO□C-□	1	NPN outputs	G7TC-OC16	2
<b>Mixed I/O Units</b>										
16 inputs and 16 outputs	NX-MD6121-6	2 Fujitsu connectors (24 p) (1 for 16 inputs and 1 for 16 outputs)	Inputs: NPN or PNP	E	1:1	XW2Z-R□C	1	NPN Inputs	G7TC-IA16/ID16	1
			Outputs: NPN		1:1	XW2Z-R□C	1	NPN outputs	G7TC-OC16	1
	NX-MD6121-5	2 MIL connectors (20 p) (1 for 16 inputs and 1 for 16 outputs)	Inputs: NPN or PNP		1:1	XW2Z-RO□C	1	NPN Inputs	G7TC-IA16/ID16	1
			Outputs: NPN		1:1	XW2Z-RO□C	1	NPN outputs	G7TC-OC16	1
	NX-MD6256-5	2 MIL connectors (20 p) (1 for 16 inputs and 1 for 16 outputs)	Inputs: NPN or PNP		1:1	XW2Z-RO□C	1	NPN Inputs	G7TC-IA16/ID16	1
			Outputs: PNP		1:1	XW2Z-RO□C	1	PNP outputs	G7TC-OC16-1	1

\* The box □ is replaced by the cable length. For details on the types, refer to pages 14 and 15.

**Note:** The G7TC-OC08 8-output type is also available.

## List of Combinations with the OMRON PLC CJ Series

CJ1W I/O Units				Conne ction pattern	XW2Z-R Cables			G7TC I/O Relay Terminals		
I/O capacity	Model	External connectors	Polarity		Connection	Model #	Quantity required	Specifications	Model	Quantity required
<b>Input Units</b>										
32 inputs	CJ1W-ID231	1 Fujitsu connector (40 p)	NPN or PNP	A	1:2	XW2Z-RI□C-□	1	NPN Inputs	G7TC-IA16/ID16	2
	CJ1W-ID232	1 MIL connector (40 p)	NPN or PNP		1:2	XW2Z-RO□□-□-D1	1	NPN Inputs	G7TC-IA16/ID16	2
	CJ1W-ID233	1 MIL connector (40 p)	NPN or PNP		1:2	XW2Z-RO□□-□-D1	1	NPN Inputs	G7TC-IA16/ID16	2
64 inputs	CJ1W-ID261	2 Fujitsu connectors (40 p) (2, 32-point connectors)	NPN or PNP	B	1:2	XW2Z-RI□C-□	2	NPN Inputs	G7TC-IA16/ID16	4
	CJ1W-ID262	2 MIL connectors (40 p) (2, 32-point connectors)	NPN or PNP		1:2	XW2Z-RO□□-□-D1	2	NPN Inputs	G7TC-IA16/ID16	4
<b>Output Units</b>										
32 outputs	CJ1W-OD231	1 Fujitsu connector (40 p)	Sinking (NPN)	A	1:2	XW2Z-RO□C-□	1	NPN outputs	G7TC-OC16	2
	CJ1W-OD233	1 MIL connector (40 p)	Sinking (NPN)		1:2	XW2Z-RO□□-□-D1	1	NPN outputs	G7TC-OC16	2
	CJ1W-OD232	1 MIL connector (40 p)	Sourcing (PNP)		1:2	XW2Z-RI□□-□-D1	1	PNP outputs	G7TC-OC16-1	2
	CJ1W-OD234	1 MIL connector (40 p)	Sinking (NPN)		1:2	XW2Z-RO□□-□-D1	1	NPN outputs	G7TC-OC16	2
64 outputs	CJ1W-OD261	2 Fujitsu connectors (40 p) (2, 32-point connectors)	Sinking (NPN)	B	1:2	XW2Z-RO□C-□	2	NPN outputs	G7TC-OC16	4
	CJ1W-OD262	2 MIL connectors (40 p) (2, 32-point connectors)	Sourcing (PNP)		1:2	XW2Z-RI□□-□-D1	2	PNP outputs	G7TC-OC16-1	4
	CJ1W-OD263	2 MIL connectors (40 p) (2, 32-point connectors)	Sinking (NPN)		1:2	XW2Z-RO□□-□-D1	2	NPN outputs	G7TC-OC16	4
<b>Mixed I/O Units</b>										
16 inputs and 16 outputs	CJ1W-MD231	2 Fujitsu connectors (24 p) (1 for 16 inputs and 1 for 16 outputs)	Inputs: Sinking/Sourcing (NPN or PNP)	E	1:1	XW2Z-R□C	1	NPN Inputs	G7TC-IA16/ID16	1
			Outputs: Sinking (NPN)		1:1	XW2Z-R□C	1	NPN outputs	G7TC-OC16	1
	CJ1W-MD233	2 MIL connectors (20 p) (1 for 16 inputs and 1 for 16 outputs)	Inputs: Sinking/Sourcing (NPN or PNP)		1:1	XW2Z-RO□C	1	NPN Inputs	G7TC-IA16/ID16	1
			Outputs: Sinking (NPN)		1:1	XW2Z-RO□C	1	NPN outputs	G7TC-OC16	1
	CJ1W-MD232	2 MIL connectors (20 p) (1 for 16 inputs and 1 for 16 outputs)	Inputs: Sinking/Sourcing (NPN or PNP)		1:1	XW2Z-RO□C	1	NPN Inputs	G7TC-IA16/ID16	1
			Inputs: Sourcing (PNP)		1:1	XW2Z-RO□C	1	PNP outputs	G7TC-OC16-1	1
32 inputs/ 32 outputs	CJ1W-MD261	2 Fujitsu connectors (40 p) (1 for 32 inputs and 1 for 32 outputs)	Inputs: Sinking/Sourcing (NPN or PNP)	B	1:2	XW2Z-RI□C-□	1	NPN Inputs	G7TC-IA16/ID16	2
			Outputs: Sinking (NPN)		1:2	XW2Z-RO□C-□	1	NPN outputs	G7TC-OC16	2
	CJ1W-MD263	2 MIL connectors (40 p) (1 for 32 inputs and 1 for 32 outputs)	Inputs: Sinking/Sourcing (NPN or PNP)		1:2	XW2Z-RO□□-□-D1	1	NPN Inputs	G7TC-IA16/ID16	2
			Outputs: Sinking (NPN)		1:2	XW2Z-RO□□-□-D1	1	NPN outputs	G7TC-OC16	2

\* The box □ is replaced by the cable length. For details on the types, refer to pages 14 and 15.

**Note:** The G7TC-OC08 8-output type is also available.

## List of Combinations with the OMRON PLC CS Series

CJ1W I/O Units				Conne tion pattern	XW2Z-R Cables			G7TC I/O Relay Terminals		
I/O capacity	Model	External connectors	Polarity		Connection	Model *	Quantity required	Specifications	Model	Quantity required
<b>Input Units</b>										
32 inputs	CS1W-ID231	1 Fujitsu connector (40 p)	NPN or PNP	A	1:2	XW2Z-RI□C-□	1	NPN Inputs	G7TC-IA16/ID16	2
64 inputs	CS1W-ID261	2 Fujitsu connectors (40 p) (2, 32-point connectors)	NPN or PNP	B	1:2	XW2Z-RI□C-□	2	NPN Inputs	G7TC-IA16/ID16	4
96 inputs	CS1W-ID291	2 Fujitsu connectors (56 p) (2, 48-point connectors)	NPN or PNP	D	1:3	XW2Z-R□C-□-□	2	NPN Inputs	G7TC-IA16/ID16	6
<b>Output Units Transistor Output Units</b>										
32 outputs	CS1W-OD231	1 Fujitsu connector (40 p)	Sinking (NPN)	A	1:2	XW2Z-RO□C-□	1	NPN outputs	G7TC-OC16	2
	CS1W-OD232	1 Fujitsu connector (40 p)	Sourcing (PNP)		1:2	---	1	PNP outputs	G7TC-OC16-1	2
64 outputs	CS1W-OD261	2 Fujitsu connectors (40 p) (2, 32-point connectors)	Sinking (NPN)	B	1:2	XW2Z-RO□C-□	2	NPN outputs	G7TC-OC16	4
	CS1W-OD262	2 Fujitsu connectors (40 p) (2, 32-point connectors)	Sourcing (PNP)		1:2	---	2	PNP outputs	G7TC-OC16-1	4
96 outputs	CS1W-OD291	2 Fujitsu connectors (56 p) (2, 48-point connectors)	Sinking (NPN)	D	1:3	XW2Z-R□C-□-□	2	NPN outputs	G7TC-OC16	6
	CS1W-OD292	2 Fujitsu connectors (56 p) (2, 48-point connectors)	Sourcing (PNP)		1:3	XW2Z-R□C-□-□	2	PNP outputs	G7TC-OC16-1	6
<b>Mixed I/O Units DC Transistor Output Units</b>										
32 inputs/ 32 outputs	CS1W-MD261	2 Fujitsu connectors (40 p) (1 for 32 inputs and 1 for 32 outputs)	Inputs: Sinking/Sourcing (NPN or PNP)	B	1:2	XW2Z-RI□C-□	1	NPN Inputs	G7TC-IA16/ID16	2
			Outputs: Sinking (NPN)		1:2	XW2Z-RO□C-□	1	NPN outputs	G7TC-OC16	2
	CS1W-MD262	2 Fujitsu connectors (40 p) (1 for 32 inputs and 1 for 32 outputs)	Inputs: Sinking/Sourcing (NPN or PNP)		1:2	XW2Z-RI□C-□	1	NPN Inputs	G7TC-IA16/ID16	2
			Outputs: Sourcing (PNP)		1:2	---	1	PNP outputs	G7TC-OC16-1	2
48 inputs/ 48 outputs	CS1W-MD291	2 Fujitsu connectors (56 p) (1 for 48 inputs and 1 for 48 outputs)	Inputs: Sinking/Sourcing (NPN or PNP)	D	1:3	XW2Z-R□C-□-□	1	NPN Inputs	G7TC-IA16/ID16	3
			Outputs: Sinking (NPN)		1:3	XW2Z-R□C-□-□	1	NPN outputs	G7TC-OC16	3
	CS1W-MD292	2 Fujitsu connectors (56 p) (1 for 48 inputs and 1 for 48 outputs)	Inputs: Sinking/Sourcing (NPN or PNP)		1:3	XW2Z-R□C-□-□	1	NPN Inputs	G7TC-IA16/ID16	3
			Outputs: Sourcing (PNP)		1:3	XW2Z-R□C-□-□	1	PNP outputs	G7TC-OC16-1	3

\* The box □ is replaced by the cable length. For details on the types, refer to pages 14 and 15.

Note: The G7TC-OC08 8-output type is also available.

Refer to the manuals for the connected PLC for the connections to I/O Units for OMRON PLCs.

Series	Model	Man. No.	Manual Name
CS1	CS1G-CPU□□□, CS1H-CPU□□□	W339	Programmable Controllers Operation Manual
CJ1	CJ1H-CPU□□□H-R, CJ1G/H-CPU□□□□, CJ1G-CPU□□□□P, CJ1M-CPU□□□, CJ1G-CPU□□□□	W393	CJ Series Programmable Controllers Operation Manual
CJ2	CJ2H-CPU6□-EIP, CJ2H-CPU6□, CJ2M-CPU□□□	W472	CJ-series CJ2 CPU Unit Hardware User's Manual
NJ	NJ501-□□□□□	W500	NJ-series CPU Unit Hardware User's Manual
NX	NX-ID□□□□□, NX-IA□□□□□, NX-OD□□□□□, NX-OC□□□□□, NX-MD□□□□□	W521	NX-series Digital I/O Units User's Manual

## List of Combinations with the Mitsubishi PLC MELSEC-L Series, MELSEC-Q Series, and MELSEC iQ-R Series

PLC I/O Unit				Connection pattern	XW2Z-R Cables			G7TC I/O Relay Terminals			
I/O capacity	Model	External connectors	Polarity		Connection	Model #1	Quantity required	Specifications	Model	Quantity required	
<b>Input Units</b>											
32 inputs	LX41C4	1 Fujitsu connector	NPN or PNP	A	1:2	XW2Z-R□□□□-□□MN	1	Inputs *2	G7TC-ID16/IA16	2	
	QX41/QX41-S1/ QX41-S2										
	QX71										
	RX41C4										
64 inputs	LX42C4	2 Fujitsu connectors	NPN or PNP	B	1:2	XW2Z-R□□□□-□□MN	2	Inputs *2	G7TC-ID16/IA16	4	
	QX42/QX42-S1										
	QX82/QX82-S1										
	RX42C4										
<b>Output Units</b>											
32 outputs	LY41NT1P	1 Fujitsu connector	NPN	A	1:2	XW2Z-RO□□□□-□□MN	1	NPN outputs	G7TC-OC16	2	
	QY41P										
	QY71										
	RY41NT2P	1 Fujitsu connector	PNP			---					
	LY41PT1P										
	RY41PT1P										
64 outputs	RY41PT2H	2 Fujitsu connectors	NPN	B	1:2	XW2Z-RO□□□□-□□MN	2	NPN outputs	G7TC-OC16	4	
	LY42NT1P										
	RY42NT2P										
	QY42P										
	LY42PT1P										2 Fujitsu connectors
RY42PT1P											
QY82P	2 Fujitsu connectors	PNP	---								
LY42PT2H											
<b>Mixed I/O Units</b>											
32 inputs/ 32 outputs	RH42C4NT2P (Input side)	2 Fujitsu connectors	NPN or PNP	B	1:2	XW2Z-R□□□□-□□MN	1	Inputs *2	G7TC-ID16/IA16	2	
	RH42C4NT2P (Output side)		NPN								XW2Z-RO□□□□-□□MN
	QH42P (Input side)	2 Fujitsu connectors	NPN or PNP			1:2	XW2Z-R□□□□-□□MN	1	Inputs *2	G7TC-ID16/IA16	2
	QH42P (Output side)		NPN								
	QX41Y41P (Input side)	2 Fujitsu connectors	NPN or PNP			1:2	XW2Z-R□□□□-□□MN	1	Inputs *2	G7TC-ID16/IA16	2
	QX41Y41P (Output side)		NPN								
	LH42C4NT1P (Input side)	2 Fujitsu connectors	NPN or PNP			1:2	XW2Z-R□□□□-□□MN	1	Inputs *2	G7TC-ID16/IA16	2
	LH42C4NT1P (Output side)		NPN								
	LH42C4PT1P (Input side)	2 Fujitsu connectors	NPN or PNP			1:2	XW2Z-R□□□□-□□MN	1	Inputs *2	G7TC-ID16/IA16	2
	LH42C4PT1P (Output side)		PNP								

**Note:** Contact for a cable length other than the above.

Cables that can be connected to the QX81, QX81-S2, and QY81P have not been prepared.

\*1. The box □ is replaced by the cable length. For details on the types, refer to pages 14 and 15.

\*2. Either NPN inputs or PNP inputs can be used.

## Terms and Conditions Agreement

### Read and understand this catalog.

Please read and understand this catalog before purchasing the products. Please consult your OMRON representative if you have any questions or comments.

### Warranties.

(a) Exclusive Warranty. Omron's exclusive warranty is that the Products will be free from defects in materials and workmanship for a period of twelve months from the date of sale by Omron (or such other period expressed in writing by Omron). Omron disclaims all other warranties, express or implied.

(b) Limitations. OMRON MAKES NO WARRANTY OR REPRESENTATION, EXPRESS OR IMPLIED, ABOUT NON-INFRINGEMENT, MERCHANTABILITY OR FITNESS FOR A PARTICULAR PURPOSE OF THE PRODUCTS. BUYER ACKNOWLEDGES THAT IT ALONE HAS DETERMINED THAT THE PRODUCTS WILL SUITABLY MEET THE REQUIREMENTS OF THEIR INTENDED USE.

Omron further disclaims all warranties and responsibility of any type for claims or expenses based on infringement by the Products or otherwise of any intellectual property right. (c) Buyer Remedy. Omron's sole obligation hereunder shall be, at Omron's election, to (i) replace (in the form originally shipped with Buyer responsible for labor charges for removal or replacement thereof) the non-complying Product, (ii) repair the non-complying Product, or (iii) repay or credit Buyer an amount equal to the purchase price of the non-complying Product; provided that in no event shall Omron be responsible for warranty, repair, indemnity or any other claims or expenses regarding the Products unless Omron's analysis confirms that the Products were properly handled, stored, installed and maintained and not subject to contamination, abuse, misuse or inappropriate modification. Return of any Products by Buyer must be approved in writing by Omron before shipment. Omron Companies shall not be liable for the suitability or unsuitability or the results from the use of Products in combination with any electrical or electronic components, circuits, system assemblies or any other materials or substances or environments. Any advice, recommendations or information given orally or in writing, are not to be construed as an amendment or addition to the above warranty.

See <http://www.omron.com/global/> or contact your Omron representative for published information.

### Limitation on Liability: Etc.

OMRON COMPANIES SHALL NOT BE LIABLE FOR SPECIAL, INDIRECT, INCIDENTAL, OR CONSEQUENTIAL DAMAGES, LOSS OF PROFITS OR PRODUCTION OR COMMERCIAL LOSS IN ANY WAY CONNECTED WITH THE PRODUCTS, WHETHER SUCH CLAIM IS BASED IN CONTRACT, WARRANTY, NEGLIGENCE OR STRICT LIABILITY.

Further, in no event shall liability of Omron Companies exceed the individual price of the Product on which liability is asserted.

### Suitability of Use.

Omron Companies shall not be responsible for conformity with any standards, codes or regulations which apply to the combination of the Product in the Buyer's application or use of the Product. At Buyer's request, Omron will provide applicable third party certification documents identifying ratings and limitations of use which apply to the Product. This information by itself is not sufficient for a complete determination of the suitability of the Product in combination with the end product, machine, system, or other application or use. Buyer shall be solely responsible for determining appropriateness of the particular Product with respect to Buyer's application, product or system. Buyer shall take application responsibility in all cases.

NEVER USE THE PRODUCT FOR AN APPLICATION INVOLVING SERIOUS RISK TO LIFE OR PROPERTY OR IN LARGE QUANTITIES WITHOUT ENSURING THAT THE SYSTEM AS A WHOLE HAS BEEN DESIGNED TO ADDRESS THE RISKS, AND THAT THE OMRON PRODUCT(S) IS PROPERLY RATED AND INSTALLED FOR THE INTENDED USE WITHIN THE OVERALL EQUIPMENT OR SYSTEM.

### Programmable Products.

Omron Companies shall not be responsible for the user's programming of a programmable Product, or any consequence thereof.

### Performance Data.

Data presented in Omron Company websites, catalogs and other materials is provided as a guide for the user in determining suitability and does not constitute a warranty. It may represent the result of Omron's test conditions, and the user must correlate it to actual application requirements. Actual performance is subject to the Omron's Warranty and Limitations of Liability.

### Change in Specifications.

Product specifications and accessories may be changed at any time based on improvements and other reasons. It is our practice to change part numbers when published ratings or features are changed, or when significant construction changes are made. However, some specifications of the Product may be changed without any notice. When in doubt, special part numbers may be assigned to fix or establish key specifications for your application. Please consult with your Omron's representative at any time to confirm actual specifications of purchased Product.

### Errors and Omissions.

Information presented by Omron Companies has been checked and is believed to be accurate; however, no responsibility is assumed for clerical, typographical or proofreading errors or omissions.