

## Chip Common Mode Choke Coil

### DLP11RB□□□UL2□

### Reference Specification

### 1.Scope

This reference specification applies to Chip Common Mode Choke Coil DLP11RB series.

### 2.Part Numbering

(ex.) DL P 11 R B 150 U L 2 L  
 (1) (2) (3) (4) (5) (6) (7) (8) (9) (10)

- |  |   |
|--|---|
| (1) Chip Common Mode Choke Coil            | (6) Common mode Impedance (Typ. at 100MHz)          |
| (2) Structure (P : Film Type)              | (7) Circuit U : Characteristic Impedance 90Ω system |
| (3) Dimension (L×W)                        | (8) Features  |
| (4) Magnetic Shield and Low Height Type    | (9) Number of Line                                  |
| (5) Category: Cut off Frequency 8GHz(Typ.) | (10) Packaging Code L : Taping / B : Bulk           |

### 3.Rating

Customer Part Number	Murata Part Number	Common Mode Impedance (at 100MHz, Under Standard Testing Condition)	Rated Voltage	Withstanding Voltage	Rated Current	DC Resistance	Insulation Resistance
	DLP11RB150UL2L	15Ω+/-5Ω	5 V(DC)	12.5V(DC)	100mA	0.8Ω+/-25%	100M Ω min.
	DLP11RB150UL2B						
	DLP11RB400UL2L	40Ω+/-10Ω	5 V(DC)	12.5V(DC)	100mA	1.3Ω+/-25%	100M Ω min.
	DLP11RB400UL2B						

Murata Part Number	Differential mode to common mode conversion characteristics (Scd21) @2.5GHz	Impedance Characteristics between signal lines Z0 (TDR@50ps)
DLP11RB150UL2L	-40dB(typ.)	90Ω+/-15Ω
DLP11RB150UL2B		
DLP11RB400UL2L	-40dB(typ.)	90Ω+/-15Ω
DLP11RB400UL2B		

Operating Temperature : -40 to +85°C      Storage Temperature : -40 to +85°C

### 4. Standard Testing Conditions

<Unless otherwise specified>  
 Temperature : Ordinary Temperature 15 to 35°C  
 Humidity : Ordinary Humidity 25 to 85%(RH)

<In case of doubt>  
 Temperature : 20 ± 2°C  
 Humidity : 60 to 70%(RH)  
 Atmospheric Pressure : 86 to 106kPa

### 5.Style and Dimensions

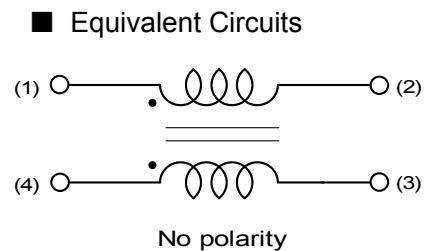
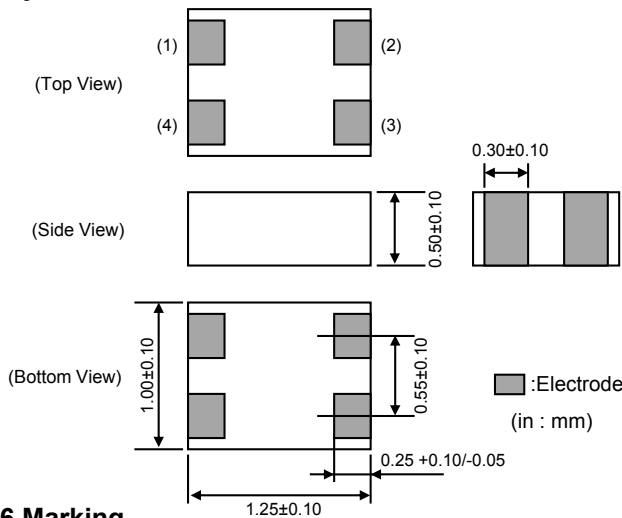

■ Unit Mass (Typical value)  
0.002g

**6.Marking**  
No Marking.

**7. Electrical Performance**

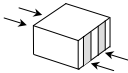
No.	Item	Specification	Test Method
7.1	Common Mode Impedance	Meet item 3.	Measuring Frequency : 100±1MHz (ref.item 10.) Measuring Equipment : KEYSIGHT4291A or the equivalents (In case of doubt, the heat treatment (200°C, about 10 minutes) shall be applied.
7.2	Withstanding Voltage	Products shall not be damaged.	Test Voltage : 2.5 times for Rated Voltage Time : 1 to 5 seconds Charge Current : 1 mA max.(ref.item 10.)
7.3	DC Resistance (Rdc)	Meet item 3.	Measuring current : 100mA max.(ref.item 10.) 
7.4	Insulation Resistance (I.R.)		Measuring voltage : Rated Voltage Measuring time : 1 minute max. (ref.item 10.)
7.5	Impedance Characteristics between signal lines (Z0)		Network Analyzer Measuring Equipment : E5071B or the equivalents (ref.item 10.)
7.6	Differential mode to common mode conversion characteristics (Scd21)		Network Analyzer Measuring Equipment : E5071B or the equivalents (ref.item 10.)

**8. Mechanical Performance**

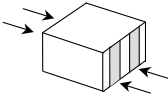
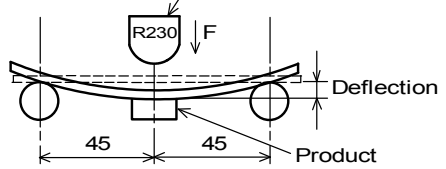
No.	Item	Specification	Test Method								
8.1	Appearance and Dimensions	Meet item 5.	Visual Inspection and measured with Slide Calipers.								
8.2	Solderability	The electrodes shall be at least 95% covered with new solder coating. 	Flux : Ethanol solution of rosin, 25(wt)% Pre-Heating : 150°C, 1minute Solder : Sn-3.0Ag-0.5Cu Solder Temperature : 245±3°C Immersion Time : 3±1 s Immersion and emersion rates : 25 mm / s								
8.3	Resistance to Soldering Heat	Meet Table 1. <table border="1"> <thead> <tr> <th colspan="2">Table 1</th> </tr> </thead> <tbody> <tr> <td>Appearance</td> <td>No damaged</td> </tr> <tr> <td>Common Mode Impedance Change</td> <td>within ± 20%</td> </tr> <tr> <td>I.R.</td> <td>100MΩ min.</td> </tr> </tbody> </table>	Table 1		Appearance	No damaged	Common Mode Impedance Change	within ± 20%	I.R.	100MΩ min.	Flux : Ethanol solution of rosin, 25(wt)% Pre-Heating : 150°C, 1minute Solder : Sn-3.0Ag-0.5Cu Solder Temperature : 270±5°C Immersion Time : 10±1 s Immersion and emersion rates : 25 mm / s Then measured after exposure in the room condition for 4 to 48 hours.
Table 1											
Appearance	No damaged										
Common Mode Impedance Change	within ± 20%										
I.R.	100MΩ min.										
8.4	Drop	<table border="1"> <tbody> <tr> <td>DC Resistance Change</td> <td>within ± 30%</td> </tr> </tbody> </table>	DC Resistance Change	within ± 30%	It shall be dropped on concrete or steel board. Method : free fall Height : 1m The Number of Times : 3 times						
DC Resistance Change	within ± 30%										
8.5	Vibration		It shall be soldered on the substrate. Oscillation Frequency : 10 to 55 to 10Hz for 1 minute Total Amplitude : 1.5mm Testing Time : A period of 2 hours in each of 3 mutually perpendicular directions.								
8.6	Bending Strength	Meet Table 2. <table border="1"> <thead> <tr> <th colspan="2">Table 2</th> </tr> </thead> <tbody> <tr> <td>Appearance</td> <td>No damaged</td> </tr> <tr> <td>DC Resistance Change</td> <td>within ± 30%</td> </tr> </tbody> </table>	Table 2		Appearance	No damaged	DC Resistance Change	within ± 30%	Substrate : (t =1.0 mm). Deflection : 2 mm Speed of Applying Force : 0.5 mm / s Keeping time : 30 s Pressure jig 		
Table 2											
Appearance	No damaged										
DC Resistance Change	within ± 30%										

**9.Environmental Performance** (Products shall be soldered on the glass-epoxy substrate)

No.	Item	Specification	Test Method
9.1	Temperature Cycle	Meet Table 1.	1 Cycle Step 1 -40°C(+0°C,-3°C) / 30(+3,-0) min Step 2 Ordinary Temp. / within 3 min Step 3 +85(+3°C,-0°C) / 30(+3,-0) min Step 4 Ordinary Temp. / within 3 min Total of 100 cycles. Then measured after exposure in the room condition for 4 to 48 hours.
9.2	Humidity		Temperature : 40±2°C Humidity : 90 to 95 % (RH) Time : 1000 hours(+48 hours,-0 hours) Then measured after exposure in the room condition for 4 to 48 hours.
9.3	Heat life		Temperature : 85±2°C Test Voltage : 2 times for Rated Voltage Time : 1000 hours(+48 hours,-0 hours) Then measured after exposure in the room condition for 4 to 48 hours. (ref. Item 10.)
9.4	Cold Resistance		Temperature : -40± 2°C Time : 1000 hours(+48 hours,-0 hours) Then measured after exposure in the room condition for 4 to 48 hours.

**10. Terminal to be Tested.**

When measuring and supplying the voltage,the following terminal is applied.

No.	Item	Terminal to be Tested
10.1	Impedance Characteristics between signal lines Differential mode to common Mode conversion characteristics	
10.2	Common Mode Impedance	
10.3	Withstanding Voltage Insulation Resistance Heat Life	
10.4	DC Resistance	

**11. Measuring method for common mode impedance.**

Measured common mode impedance may be included measurement error due to stray capacitance, residual inductance of test fixture.

To correct this error, the common mode impedance should be calculate as follows;

- (1) Measure admittance of the fixture(opened),  $G_o$   $B_o$ .
- (2) Measure impedance of the fixture(shorted),  $R_s$   $X_s$ .
- (3) Measure admittance of the specimen,  $G_m$   $B_m$ .
- (4) Calculate corrected impedance  $|Z|$  using the formula below.

$$|Z| = (R_x^2 + X_x^2)^{1/2}$$

Where

$$R_x = \frac{G_m - G_o}{(G_m - G_o)^2 + (B_m - B_o)^2} - R_s$$

$$X_x = \frac{-(B_m - B_o)}{(G_m - G_o)^2 + (B_m - B_o)^2} - X_s$$

**12. P.C.B., Flux, Solder and Soldering condition**

Test shall be done using P.C.B., Flux, Solder and Soldering condition which are specified in item 16 except the case of being specified special condition.

**13. Impedance Frequency Characteristics(Typical)**

**• DLP11RB150UL2**

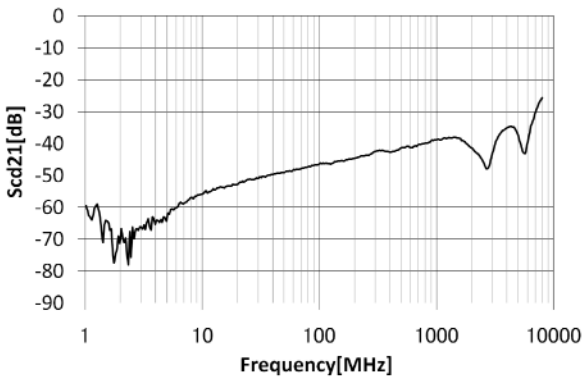
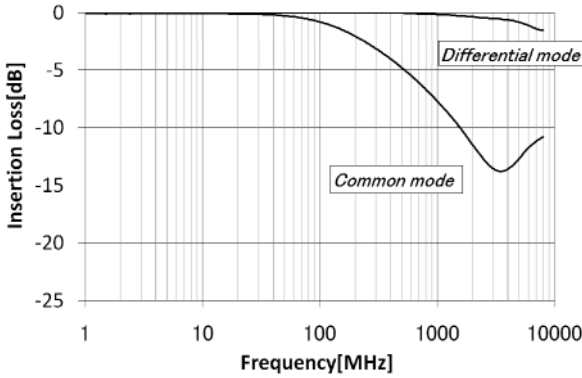
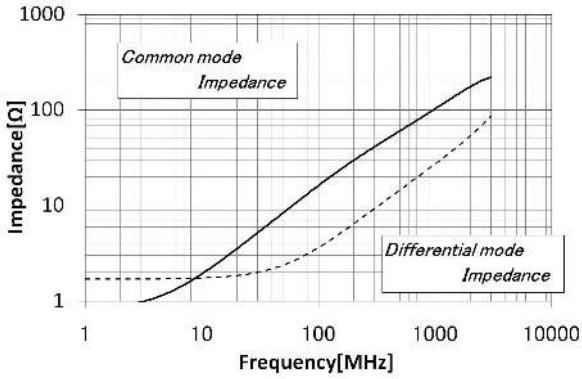

**• DLP11RB400UL2**

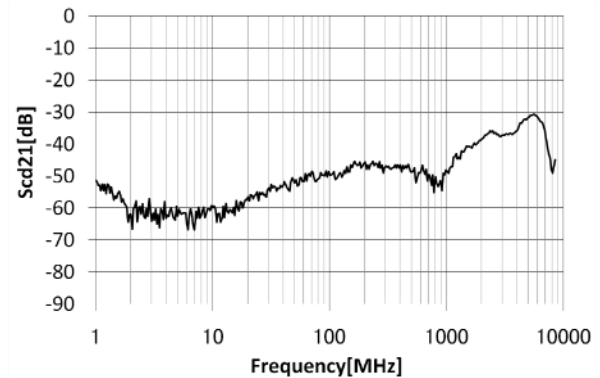
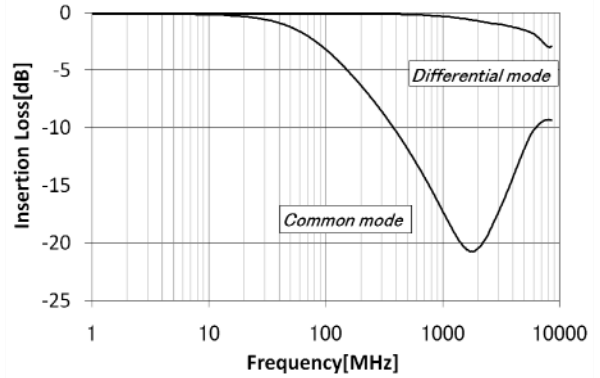
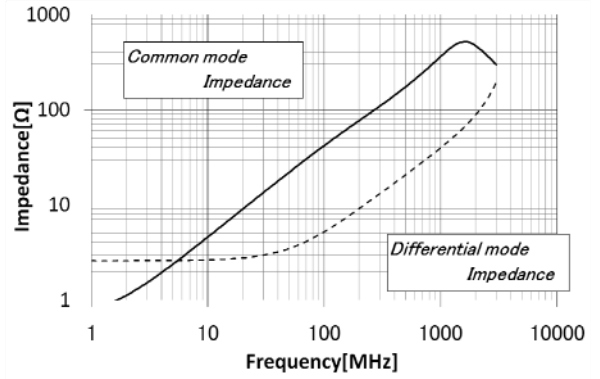

**14. Specification of Packaging**

**14.1 Appearance and Dimensions ( 8mm-wide,Plastic tape)**

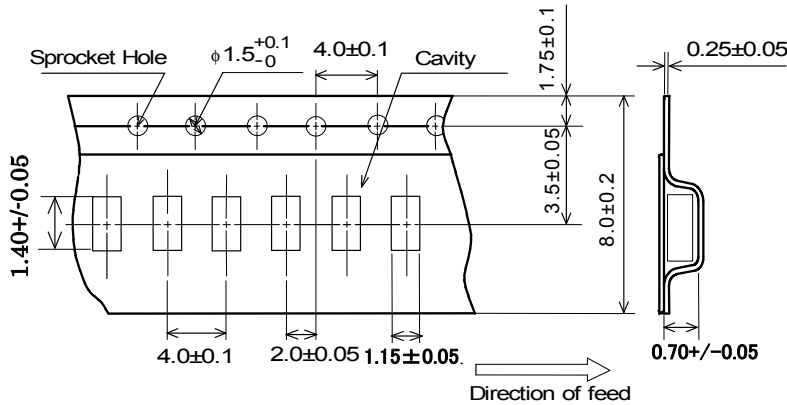

\*Dimension of the Cavity is measured at the bottom side.

(in:mm)

**14.2 Specification of Taping**

- (1)Packing quantity(Standard quantity) 4000 pcs. / reel
- (2)Packing Method  
Products shall be packaged in each embossed cavity of plastic tape and sealed with cover tape.
- (3)Sprocket Hole  
The sprocket holes are to the right as the tape is pulled toward the use
- (4)Spliced point  
The cover tape have no spliced point.
- (5)Missing components number  
Missing components number within 0.1% of the number per reel or 1 pc., whichever is greater, and are not continuous. The specified quantity per reel is kept.

**14.3 Pull Strength of Plastic Tape**

Plastic Tape	5N min.
Cover Tape	10N min.

**14.4 Peeling off force of Cover Tape**

0.2 to 0.7N(Minimum value is Typical)  
Speed of Peeling off : 300 mm/min.

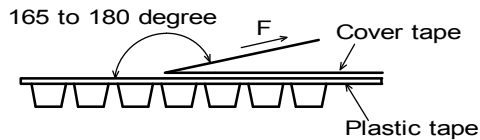

**14.5 Dimensions of Leader-tape, Trailer and Reel**

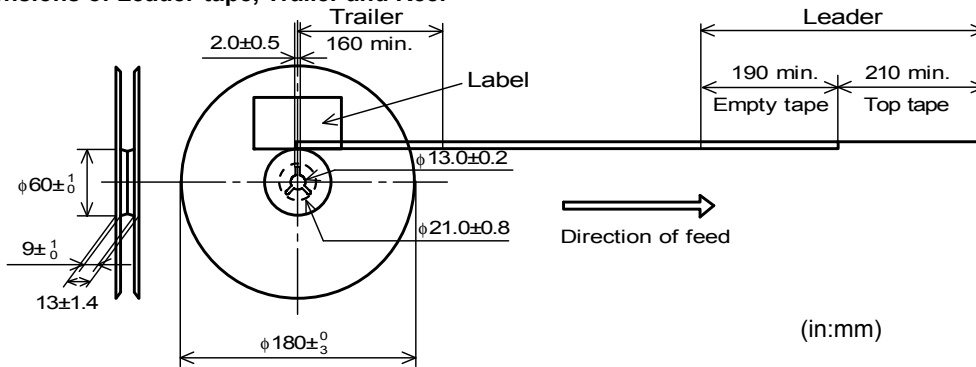

(in:mm)



**16.3 Resin coating**

The impedance value may change and/or it may affect on the product's performance due to high cure-stress of resin to be used for coating / molding products. So please pay your careful attention when you select resin. In prior to use, please make the reliability evaluation with the product mounted in your application set.

**16.4 Attention regarding P.C.B. bending**

The following shall be considered when designing and laying out P.C.B.'s.

(1) P.C.B. shall be designed so that products are not subject to the mechanical stress due to warping the board.

[Products direction]

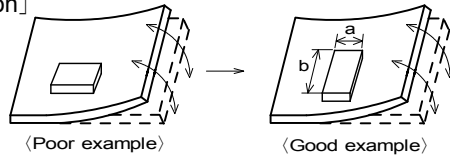

Products shall be location the sideways Direction (Length :  $a < b$ ) to the mechanical Stress.

(2) Components location on P.C.B. separation.

It is effective to implement the following measures, to reduce stress in separating the board.

It is best to implement all of the following three measures; however, implement as many measures as possible to reduce stress.

Contents of Measures	Stress Level
(1) Turn the mounting direction of the component parallel to the board separation surface.	A > D *1
(2) Add slits in the board separation part.	A > B
(3) Keep the mounting position of the component away from the board separation surface.	A > C

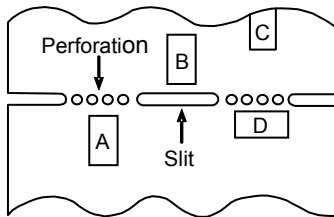

\*1 A > D is valid when stress is added vertically to the perforation as with Hand Separation.

If a Cutting Disc is used, stress will be diagonal to the PCB, therefore A > D is invalid.

(3) Mounting Components Near Screw Holes

When a component is mounted near a screw hole, it may be affected by the board deflection that occurs during the tightening of the screw. Mount the component in a position as far away from the screw holes as possible.

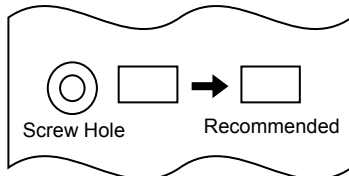

**16.5 Attention Regarding P.C.B. Design**

< The Arrangement of Products >

P.C.B. shall be designed so that products are far from the portion of perforation.

The portion of perforation shall be designed as narrow as possible, and shall be designed so as not to be applied the stress in the case of P.C.B. separation.

Products shall not be arranged on the line of a series of holes when there are big holes in P.C.B.

(Because the stress concentrate on the line of holes.)

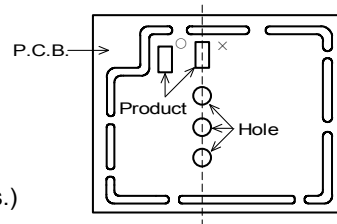
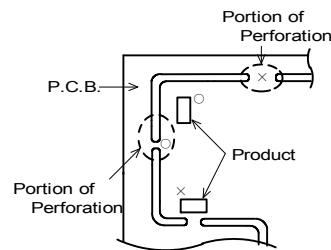

< Products Placing >

Support pins shall be set under P.C.B .  
to prevent causing a warp to P.C.B.  
during placing the products on the other side of P.C.B.

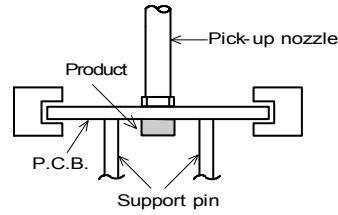

< P.C.B. Separation >

P.C.B. shall not be separated with hand.  
P.C.B. shall be separated with the fixture so as not to cause P.C.B. bending.

**16.6 Attention Regarding P.C.B. Mounting**

In case of mounting by use of mounting machine, please choose nozzle which can pick up components of 1005 size or the equivalents.

**16.7 Standard Land Dimensions**

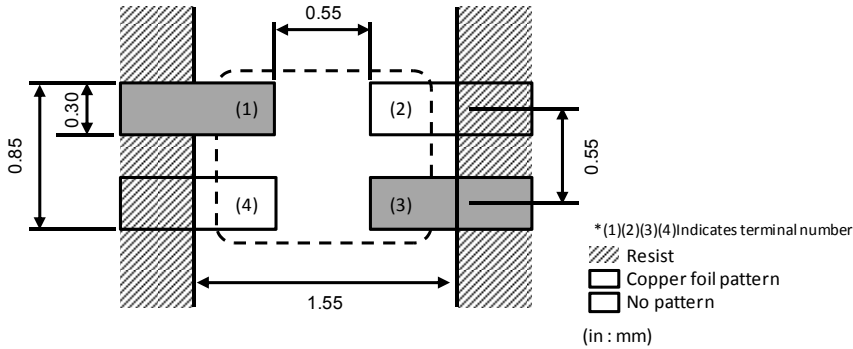

**16.8 Soldering(Reflow soldering)**

Standard soldering profile and the limit soldering profile is as follows.  
The excessive limit soldering conditions may cause leaching of the electrode and / or resulting in the deterioration of product quality.

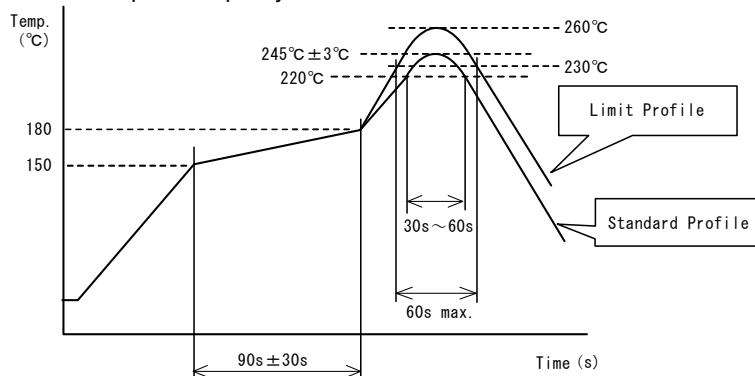

	Standard Profile	Limit Profile
Pre-heating	150~180°C、90s±30s	
Heating	above 220°C、30s~60s	above 230°C、60s max.
Peak temperature	245±3°C	260°C、10s
Cycle of reflow	2 times	2 times

(1) Standard printing pattern of solder paste

- Standard thickness of the solder paste should be around 100µm.
- Use the solder paste printing pattern of the right pattern.
- For the resist and copper foil pattern, use standard land dimension
- Use Sn-3.0Ag-0.5Cu solder.

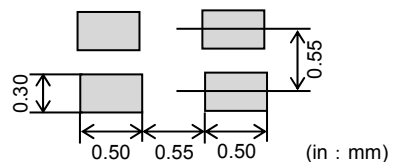

(2) Reworking with Soldering iron

- The following conditions shall be strictly followed when using a soldering iron after being mounted by reflow soldering.
  - Pre-heating: 150°C, 1 min
  - Tip temperature: 380°C max.
  - Soldering time : 3(+1,-0) seconds.
  - Soldering iron output: 30W max.
  - Tip diameter: φ3mm max.
  - Times : 2times max.
- Do not touch the products directly with the tip of the soldering iron.



## (3) Solder Volume

Solder shall be used not to be exceeded the upper limits as shown below.

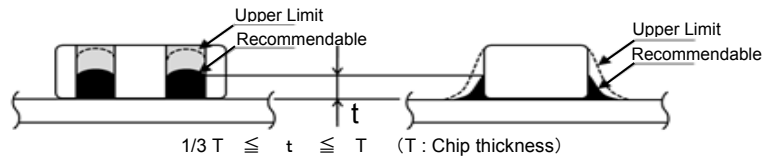

Accordingly increasing the solder volume, the mechanical stress to product is also increased. Excessive solder volume may cause the failure of mechanical or electrical performance.

**16.9 Cleaning Conditions**

Products shall be cleaned on the following conditions.

- (1) Cleaning temperature shall be limited to 60°C max. (40°C max. for Isopropyl alcohol.)
- (2) Ultrasonic cleaning shall comply with the following conditions, avoiding the resonance phenomenon at the mounted products and P.C.B..
  - Power : 20W/l max. • Frequency : 28kHz to 40kHz • Time : 5 minutes max.
- (3) Cleaner
  1. Alternative cleaner • Isopropyl alcohol (IPA)
  2. Aqueous agent • PINE ALPHA ST-100S
- (4) There shall be no residual flux and residual cleaner after cleaning.
 

In the case of using aqueous agent, products shall be dried completely after rinse with de-ionized water in order to remove the cleaner.
- (5) Other cleaning
 

Please contact us.

**16.10 Handling of a substrate**

After mounting products on a substrate, do not apply any stress to the product caused by bending or twisting to the substrate when cropping the substrate, inserting and removing a connector from the substrate or tightening screw to the substrate.

Excessive mechanical stress may cause cracking in the product.

Bending

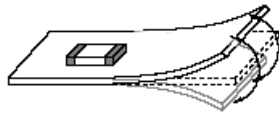

Twisting

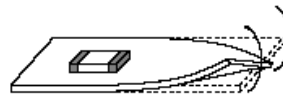
**16.11 Operating Environment**

Do not use this product under the following environmental conditions, on deterioration of the performance, such as insulation resistance may result from the use.

- (1) in corrosive gases (acidic gases, alkaline gases, chlorine, sulfur gases, organic gases and etc.)
- (2) in the atmosphere where liquid such as organic solvent, may splash on the products.

**16.12 Storage Conditions**

## (1) Storage period

Use the products within 12 months after delivered.

Solderability should be checked if this period is exceeded.

## (2) Storage environment condition

- Products should be stored in the warehouse on the following conditions.

Temperature : -10 to +40°C

Humidity : 15 to 85% relative humidity

No rapid change on temperature and humidity

- Products should not be stored in corrosive gases, such as sulfurous, acid gases, alkaline gases, to prevent the following deterioration.
 

Poor solderability due to the oxidized electrode.
- Products should be stored on the palette for the prevention of the influence from humidity, dust and so on.
- Products should be stored in the warehouse without heat shock, vibration, direct sunlight and so on.
- Products should be stored under the airtight packaged condition.

## (3) Delivery

Care should be taken when transporting or handling product to avoid excessive vibration or mechanical shock.

17. **△Note**

- (1) Please make sure that your product has been evaluated in view of your specifications with our product being mounted to your product.
- (2) You are requested not to use our product deviating from the reference specifications.
- (3) The contents of this reference specification are subject to change without advance notice. Please approve our product specifications or transact the approval sheet for product specifications before ordering.