

Development Board EPC9034 Quick Start Guide

80 V Half-bridge with Gate Drive, Using EPC2021

Revision 2.0

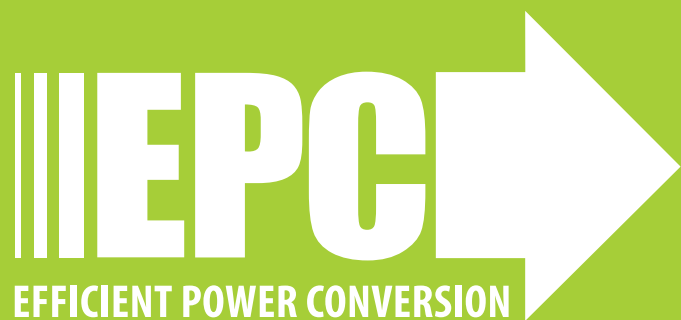

DESCRIPTION

The EPC9034 development board is a 80 V maximum device voltage, 35 A maximum output current, half bridge with onboard gate drives, featuring the EPC2021 enhancement mode (eGaN®) field effect transistor (FET). The purpose of this development board is to simplify the evaluation process of the EPC2021 eGaN FET by including all the critical components on a single board that can be easily connected into the majority of existing converter topologies.

The EPC9034 development board measures 2" x 2" and contains two EPC2021 eGaN FETs in a half bridge configuration using the Texas Instruments LMG1205 gate driver. The board also contains all critical components and the layout supports optimal switching performance. There are also various probe points to facilitate simple waveform measurement and efficiency calculation. A block diagram of the circuit is given in figure 1.

For more information on the EPC2021 please refer to the datasheet available from EPC at www.epc-co.com. The datasheet should be read in conjunction with this quick start guide.

QUICK START PROCEDURE

The half bridge development board EPC9034 is easy to set up as buck or boost converter. Refer to figure 2 for buck converter configuration and measurement setup, and figure 3 for boost converter setup, and follow the procedure below:

Buck converter configuration

1. With power off, connect the input power supply bus to V_{IN} (J5, J6) and ground / return to GND.
2. With power off, connect the switch node (SW) of the half bridge to your circuit as required (half bridge configuration). Or use the provided pads for inductor (L_1) and output capacitors (C_{out}), as shown in figure 2 with a DC load connected across V_{OUT} and GND.
3. With power off, connect the gate drive supply to V_{DD} (J1, Pin-1) and ground return to GND (J1, Pin-2 indicated on the bottom side of the board).
4. With power off, connect the input PWM control signal to PWM1 (J2, Pin-1) and ground return to any of GND J2 pins indicated on the bottom side of the board.
5. Turn on the gate drive supply – make sure the supply is between 7.5 V and 12 V.
6. Turn on the controller / PWM input source.
7. Making sure the initial input supply voltage is 0 V, turn on the power and slowly increase the voltage to the required value (do not exceed the absolute maximum voltage). Probe switching node to see switching operation.
8. Once operational, adjust the PWM control, bus voltage, and load within the operating range and observe the output switching behavior, efficiency and other parameters.
9. For shutdown, please follow steps in reverse.

Table 1: Performance Summary ($T_A = 25^\circ\text{C}$) EPC9034

Symbol	Parameter	Conditions	Min	Max	Units
V_{DD}	Gate Drive Input Supply Range		7	12	V
V_{IN}	Bus Input Voltage Range ⁽¹⁾			64 ⁽¹⁾	V
I_{OUT}	Switch Node Output Current ⁽²⁾			35 ⁽²⁾	A
V_{PWM}	PWM Logic Input Voltage Threshold	Input 'High' Input 'Low'	3.5 0	6 1.5	V V
V_{SW}	Switch-node Voltage			64 ⁽¹⁾	
	Minimum 'High' State Input Pulse Width	V_{PWM} rise and fall time < 10ns	50		ns
	Minimum 'Low' State Input Pulse Width ⁽³⁾	V_{PWM} rise and fall time < 10ns	100 ⁽³⁾		ns

(1) Maximum input voltage depends on inductive loading, maximum switch node ringing must be kept under 80 V for EPC2021.

(2) Maximum current depends on die temperature – actual maximum current will be subject to switching frequency, bus voltage and thermal cooling.

(3) Limited by time needed to 'refresh' high side bootstrap supply voltage.



Front view

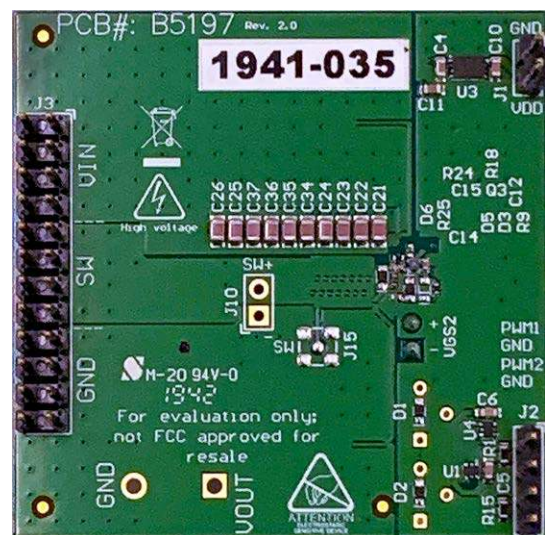

Back view

EPC9034 development board

Boost Converter configuration

Warning: Never operate the boost converter mode without a load as the output voltage can increase beyond the maximum ratings.

1. The inductor (L_1) and input capacitors (labeled as C_{out}) can either be soldered onto the board, as shown in figure 3, or provided off board. Anti-parallel diodes can also be installed using the additional pads on the right side of the EPC2021 FETs.
2. With power off, connect the input power supply bus to V_{OUT} (J9, Pin-1) and ground / return to GND (J9, Pin-2), or externally across the capacitor if the inductor L_1 and C_{out} are provided externally. Connect the output voltage (labeled as V_{IN} , J5, J6) to your circuit as required, e.g., resistive load.
3. With power off, connect the gate drive supply to V_{DD} (J1, Pin-1) and ground return to GND (J1, Pin-2 indicated on the bottom side of the board).
4. With power off, connect the input PWM control signal to PWM1 (J2, Pin-1) and ground return to any of GND J2 pins indicated on the bottom side of the board. Note that the bottom FET gate drive signal is inverted with regard to PWM1. It is also possible to use separate input PWM signals by removing R2 and R17 and installing 0 Ω jumpers for R14 and R16.
5. Turn on the gate drive supply – make sure the supply is between 7.5 V and 12 V.
6. Turn on the controller / PWM input source.
7. Making sure the output is not open circuit, and the input supply voltage is initially 0 V, turn on the power and slowly increase the voltage to the required value (do not exceed the absolute maximum voltage). Probe switching node to see switching operation.
8. Once operational, adjust the PWM control, bus voltage, and load within the operating range and observe the output switching behavior, efficiency and other parameters. Observe device temperature for operational limits.
9. For shutdown, please follow steps in reverse.

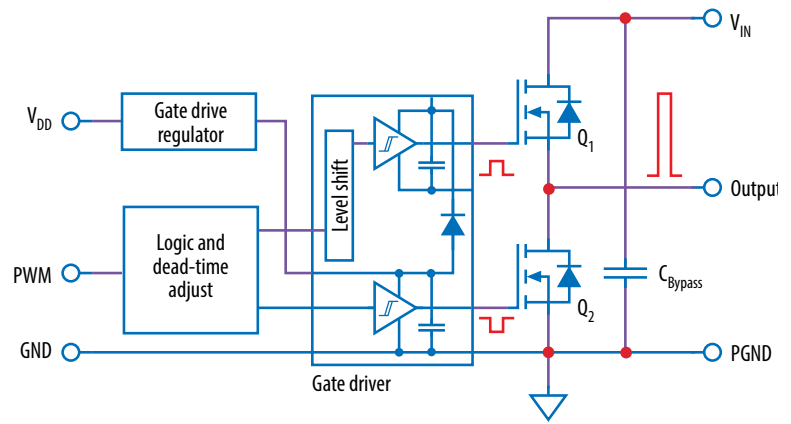

Figure 1: Block diagram of EPC9034 development board

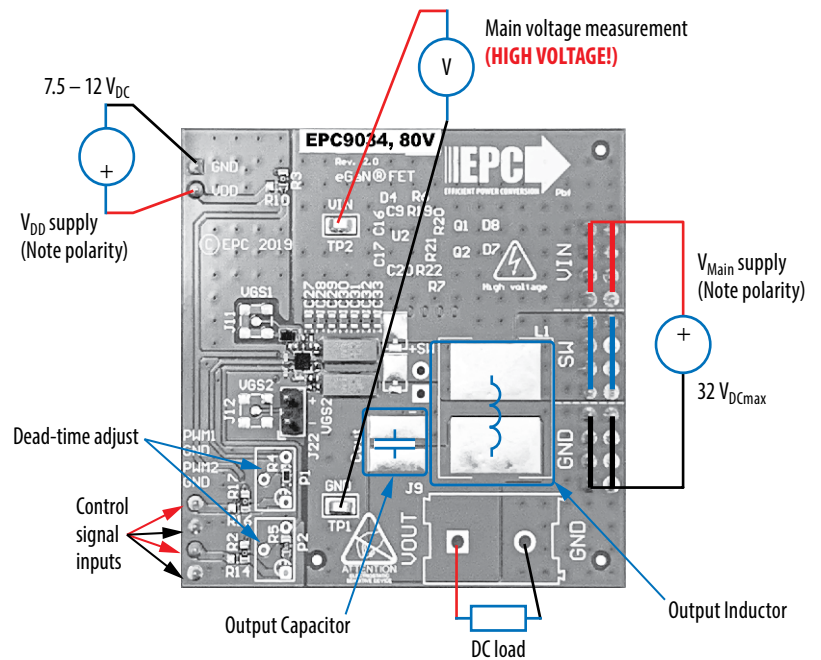

Figure 2: Buck configuration

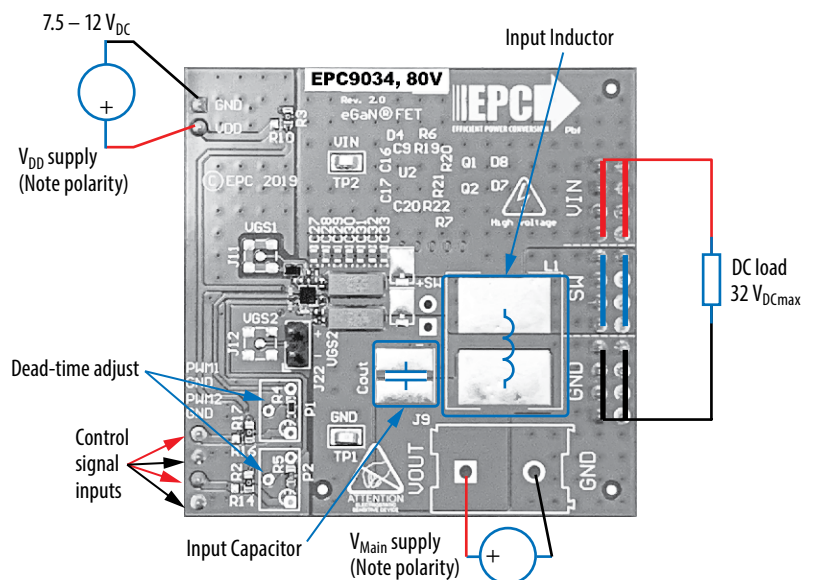

Figure 3: Boost configuration

THERMAL CONSIDERATIONS

The EPC9034 development board showcases the EPC2021 eGaN FET. The EPC9034 is intended for bench evaluation with low ambient temperature and convection cooling. The addition of heat-sinking and forced air cooling can significantly increase the current rating of these devices, but care must be taken to not exceed the absolute maximum die temperature of 150° C.

NOTE. The EPC9034 development board does not have any current or thermal protection on board. For more information regarding the thermal performance of EPC eGaN FETs, please consult:

D. Reusch and J. Glaser, *DC-DC Converter Handbook*, a supplement to *GaN Transistors for Efficient Power Conversion*, First Edition, Power Conversion Publications, 2015.

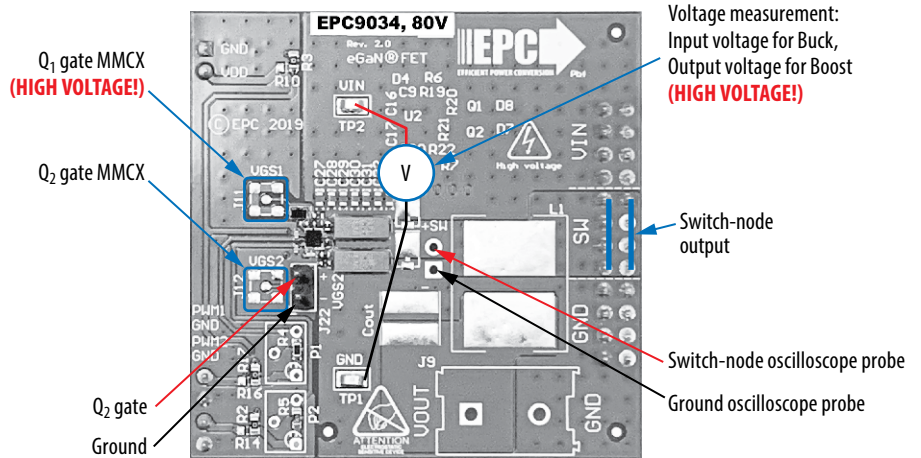

Figure 4: Measurement top side

MEASUREMENT CONSIDERATIONS

When measuring the high frequency content switch node, care must be taken to provide an accurate high speed measurement. An optional two pin header (J10) is included for switch node measurement. MMCX connector footprint is also provided (J15 in figure 5) to measure switch node.

Low-side gate voltage (V_{GS2}) can be measured at the two pin header (J22) or the MMCX (J12). Please refer to figure 4. R7 (0 Ω resistor) will need to be installed.

High-side gate voltage (V_{GS1}) can only be measured using the MMCX connector (J11). Please refer to figure 4. R6 (0 Ω resistor) will need to be installed.

Differential probe is recommended for measuring high-side gate. IsoVu probes from Tektronix has mating MMCX connector.

For regulator passive voltage probes (e.g. TPP1000) measuring low-side gate or switch node using MMCX connector, probe adaptor is available. PN: 206-0663-xx.

NOTE. For information about measurement techniques, the EPC website offers: [“AN023 Accurately Measuring High Speed GaN Transistors”](#) and the How to GaN educational video series, including: [HTG09- Measurement](#)

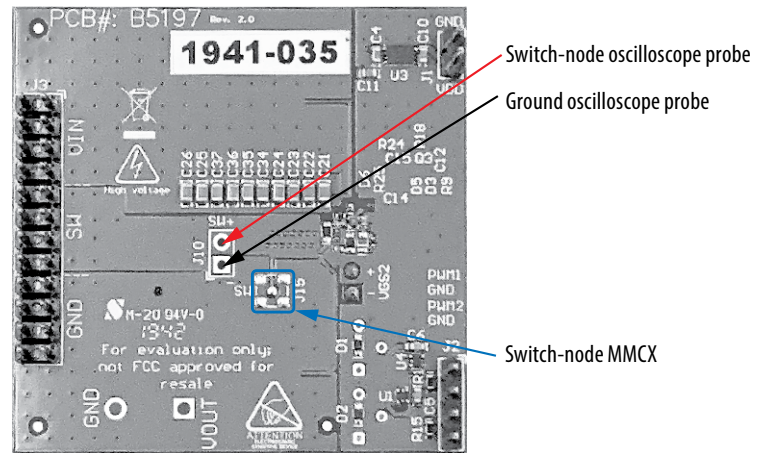

Figure 5: Measurement bottom side.

Table 2: Bill of Materials

Item	Qty	Reference	Part Description	Manufacturer	Part Number
1	3	C4, C10, C11	Capacitor, 1 μ F, \pm 10%, 25 V X7R	TDK	C1608X7R1E105K
2	2	C5, C6	Capacitor, 0.1 μ F, \pm 10%, 25 V X7R	TDK	C1608X7R1E104K
3	1	C9	Capacitor, 0.1 μ F, \pm 10%, 25 V X7R	Yageo	CC0402KRX7R8BB104
4	2	C12, C14	Capacitor, 0.1 μ F, \pm 10%, 16 V X7R	Murata	GRM155R71C104KA88D
5	1	C15	Capacitor, 0.022 μ F, \pm 10%, 25 V X7R	TDK	C1005X7R1E223K050BB
6	2	C16, C17	Capacitor, 100 pF, \pm 10%, 50 V X7R	Yageo	CC0402KRX7R9BB101
7	1	C20	Capacitor, 4.7 μ F, \pm 10%, 10 V X5R	TDK	C1005X5R1A475K050BC
8	10	C21, C22, C23, C24, C25, C26, C34, C35, C36, C37	Capacitor, 1 μ F, \pm 20%, 100 V X7S	TDK	C2012X7S2A105M125AB
9	7	C27, C28, C29, C30, C31, C32, C33	Capacitor, 0.22 μ F, \pm 10%, 100 V X7S	Taiyo Yuden	HMK107C7224
10	4	D1, D2, D5, D6	Schottky Diode, 30 V 30 mA	Diodes Inc.	SDM03U40
11	1	D4	Zener Diode, 5.1 V, 150 mW, \pm 5%	Bournes	CD0603-Z5V1
12	1	U2	100 V eGaN Driver	TI	LMG1205YFXR
13	2	Q1, Q2	eGaN FET, 80 V, 2.5 m Ω	EPC	EPC2021
14	1	Q3	eGaN FET, 100 V, 3300 m Ω	EPC	EPC2038
15	2	R1, R15	Resistor, 10 k Ω , \pm 5%, 1/10 W	Yageo	RC0603JR-0710KL
16	3	R2, R3, R17	Resistor, 0.0 Ω , 1/16 W	Stackpole	RMCF0603ZT0R00
17	1	R4	Resistor, 10 Ω , \pm 1%, 1/10 W	Panasonic	ERJ-3EKF10R0V
18	1	R5	Resistor, 100 Ω , \pm 1% 0.1 W, 1/10 W	Panasonic	ERJ-3EKF1000V
19	1	R9	Resistor, 0 Ω Jumper 0.063 W, 1/16 W	Stackpole	RMCF0402ZT0R00
20	2	R19, R21	Resistor, 2.7 Ω , \pm 5% 0.1 W, 1/10 W	Panasonic	ERJ-2GEJ2R7X
21	2	R20, R22	Resistor, 500 m Ω , \pm 1% 0.125 W, 1/8 W	Stackpole	PT0402FR-7W0R5L
22	1	R24	Resistor, 27 k Ω , \pm 5% 0.1 W, 1/10 W	Panasonic	ERJ-2GEJ273X
23	1	R25	Resistor, 20 Ω , \pm 5% 0.063 W, 1/16 W	Stackpole	RMCF0402JT20R0
24	1	U3	I.C., Regulator	Microchip	MCP1703T-5002E/MC
25	1	U1	I.C., Logic	Fairchild	NC7SZ00L6X
26	1	U4	I.C., Logic	Fairchild	NC7SZ08L6X
27	2	J1, J22	Connector	Würth	61300211121
28	2	J2, J3	Connector	Tyco	4-103185-0-04
29	2	TP1, TP2	SMT test point	Keystone	5015

Optional Components

Item	Qty	Reference	Part Description	Manufacturer	Part Number
1	DNP	Cout	TBD	Generic	Generic
2	DNP	D3	Schottky Diode, 40 V 300 mA	ST	BAT54KFILM
3	DNP	D7, D8	Schottky Diode, 100 V 2A	Vishay	SS2PH10-M3
4	DNP	L1	Inductor - TBD	Generic	Generic
5	DNP	P1, P2	Potentiometer, 1 k Ω 0.25 W, 1/4 W	Murata	PV37W102C01B00
6	DNP	R10, R14, R16	Resistor, 0 Ω Jumper 0.1 W, 1/10 W	Stackpole	RMCF0603ZT0R00
7	DNP	R6, R7	Resistor, 0 Ω Jumper 0.063 W, 1/16 W	Stackpole	RMCF0402ZT0R00
8	DNP	R18	Resistor, 4.7 Ω , \pm 5% 0.1 W, 1/10 W	Panasonic	ERJ-2GEJ4R7X
9	DNP	J9	7.62 mm Euro Term.	Würth	691216410002
10	DNP	J10	.1" Male Vert.	Würth	61300211121
11	DNP	J11, J12, J15	Connector	Molex	0734152063

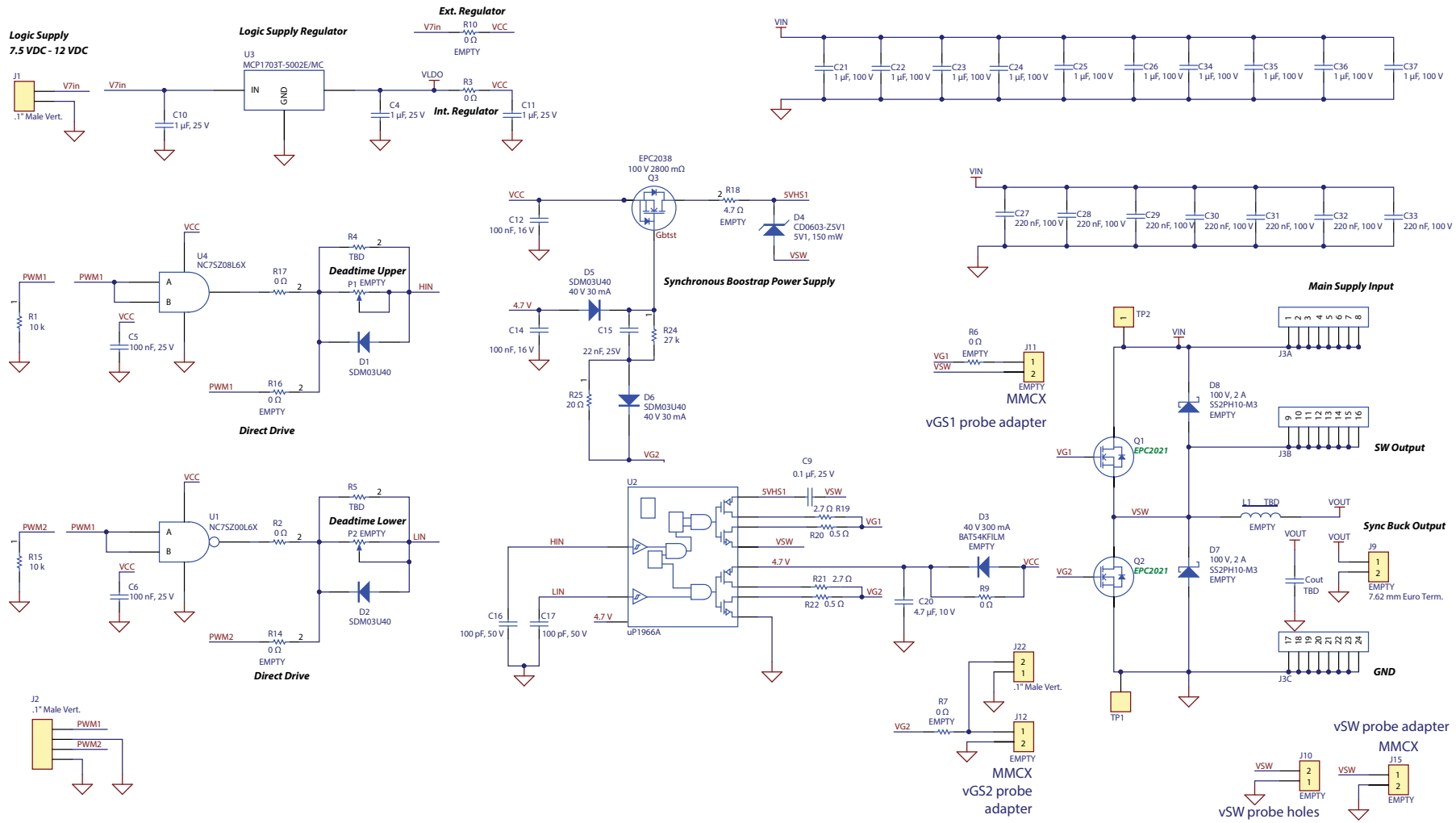

Figure 6: EPC9034 - Schematic

For More Information:

Please contact info@epc-co.com
or your local sales representative

Visit our website:
www.epc-co.com

Sign-up to receive
EPC updates at
bit.ly/EPCupdates
or text "EPC" to 22828



EPC Products are distributed through Digi-Key.
www.digikey.com

Demonstration Board Notification

The EPC9034 board is intended for product evaluation purposes only. It is not intended for commercial use nor is it FCC approved for resale. Replace components on the Evaluation Board only with those parts shown on the parts list (or Bill of Materials) in the Quick Start Guide. Contact an authorized EPC representative with any questions. This board is intended to be used by certified professionals, in a lab environment, following proper safety procedures. Use at your own risk.

As an evaluation tool, this board is not designed for compliance with the European Union directive on electromagnetic compatibility or any other such directives or regulations. As board builds are at times subject to product availability, it is possible that boards may contain components or assembly materials that are not RoHS compliant. Efficient Power Conversion Corporation (EPC) makes no guarantee that the purchased board is 100% RoHS compliant.

The Evaluation board (or kit) is for demonstration purposes only and neither the Board nor this Quick Start Guide constitute a sales contract or create any kind of warranty, whether express or implied, as to the applications or products involved.

Disclaimer: EPC reserves the right at any time, without notice, to make changes to any products described herein to improve reliability, function, or design. EPC does not assume any liability arising out of the application or use of any product or circuit described herein; neither does it convey any license under its patent rights, or other intellectual property whatsoever, nor the rights of others.