

IRGB4059DPbF

INSULATED GATE BIPOLAR TRANSISTOR WITH ULTRAFAST SOFT RECOVERY DIODE

Features

- Low $V_{CE(on)}$ Trench IGBT Technology
- Low Switching Losses
- Maximum Junction temperature 175 °C
- 5µs SCSOA
- Square RBSOA
- 100% of The Parts Tested for 4X Rated Current (I_{LM})
- Positive $V_{CE(on)}$ Temperature Coefficient.
- Ultra Fast Soft Recovery Co-pak Diode
- Tighter Distribution of Parameters
- Lead-Free Package

Benefits

- High Efficiency in a Wide Range of Applications
- Suitable for a Wide Range of Switching Frequencies due to Low $V_{CE(ON)}$ and Low Switching Losses
- Rugged Transient Performance for Increased Reliability
- Excellent Current Sharing in Parallel Operation
- Low EMI

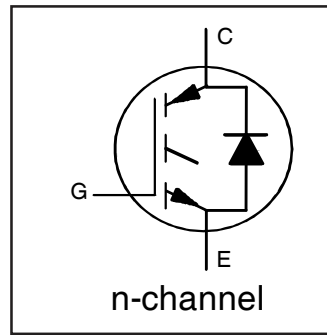

| |
|---|
| $V_{CES} = 600V$ |
| $I_C = 4.0A, T_C = 100^\circ C$ |
| $t_{sc} > 5\mu s, T_{jmax} = 175^\circ C$ |
| $V_{CE(on) typ.} = 1.75V$ |

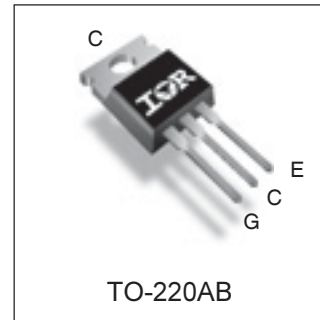

| | | |
|----------|-----------|----------|
| G | C | E |
| Gate | Collector | Emitter |

Absolute Maximum Ratings

| | Parameter | Max. | Units |
|---------------------------|---|-----------------------------------|-------|
| V_{CES} | Collector-to-Emitter Breakdown Voltage | 600 | V |
| $I_C @ T_C = 25^\circ C$ | Continuous Collector Current | 8 | A |
| $I_C @ T_C = 100^\circ C$ | Continuous Collector Current | 4 | |
| I_{CM} | Pulsed Collector Current | 16 | |
| I_{LM} | Clamped Inductive Load Current ① | 16 | |
| $I_F @ T_C = 25^\circ C$ | Diode Continuous Forward Current | 8 | |
| $I_F @ T_C = 100^\circ C$ | Diode Continuous Forward Current | 4 | |
| I_{FM} | Diode Maximum Forward Current ② | 16 | |
| V_{GE} | Continuous Gate-to-Emitter Voltage | ± 20 | V |
| | Transient Gate-to-Emitter Voltage | ± 30 | |
| $P_D @ T_C = 25^\circ$ | Maximum Power Dissipation | 56 | W |
| $P_D @ T_C = 100^\circ$ | Maximum Power Dissipation | 28 | |
| T_J T_{STG} | Operating Junction and Storage Temperature Range | -55 to + 175 | °C |
| | Soldering Temperature, for 10 seconds | 300 (0.063 in. (1.6mm) from case) | |

Thermal Resistance

| | Parameter | Min. | Typ. | Max. | Units |
|-----------------|---|------|------|------|-------|
| $R_{\theta JC}$ | Junction-to-Case - IGBT ③ | | | 2.70 | °C/W |
| $R_{\theta JC}$ | Junction-to-Case - Diode ③ | | | 6.30 | |
| $R_{\theta CS}$ | Case-toSink, flat, greased surface | | 0.5 | | |
| $R_{\theta JA}$ | Junction-to-Ambient, typical socket mount ③ | | 80 | | |
| Wt | Weight | | 1.44 | | g |

Electrical Characteristics @ $T_J = 25^\circ\text{C}$ (unless otherwise specified)

| | Parameter | Min. | Typ. | Max. | Units | Conditions | Ref.Fig |
|---------------------------------|---|------|------|-----------|---------------------|---|-------------------|
| $V_{(BR)CES}$ | Collector-to-Emitter Breakdown Voltage | 600 | — | — | V | $V_{GE} = 0V, I_C = 100 \mu A$ ④ | CT6 |
| $\Delta V_{(BR)CES}/\Delta T_J$ | Temperature Coeff. of Breakdown Voltage | — | 0.3 | — | $V/^\circ\text{C}$ | $V_{GE} = 0V, I_C = 250 \mu A$ (25 -175 $^\circ\text{C}$) ④ | |
| $V_{CE(on)}$ | Collector-to-Emitter Saturation Voltage | — | 1.75 | 2.05 | | $I_C = 4A, V_{GE} = 15V, T_J = 25^\circ\text{C}$ | 5,6,7,9, 10,11 |
| | | — | 2.15 | — | V | $I_C = 4A, V_{GE} = 15V, T_J = 150^\circ\text{C}$ | |
| | | — | 2.20 | — | | $I_C = 4A, V_{GE} = 15V, T_J = 175^\circ\text{C}$ | |
| $V_{GE(th)}$ | Gate Threshold Voltage | 4.0 | | 6.5 | V | $V_{CE} = V_{GE}, I_C = 100 \mu A$ | 9,10,11,12 |
| $\Delta V_{GE(th)}/\Delta T_J$ | Threshold Voltage temp. coefficient | — | -18 | — | $mV/^\circ\text{C}$ | $V_{CE} = V_{GE}, I_C = 250 \mu A$ (25 -175 $^\circ\text{C}$) | |
| g_{fe} | Forward Transconductance | — | 2.0 | — | S | $V_{CE} = 50V, I_C = 4A, PW = 80\mu s$ | |
| I_{CES} | Collector-to-Emitter Leakage Current | — | 1 | 25 | μA | $V_{GE} = 0V, V_{CE} = 600V$ | 8 |
| | | — | 280 | — | μA | $V_{GE} = 0V, V_{CE} = 600V, T_J = 175^\circ\text{C}$ | |
| V_{FM} | Diode Forward Voltage Drop | — | 1.60 | 2.30 | V | $I_F = 4A$ | |
| | | — | 1.30 | — | | $I_F = 4A, T_J = 175^\circ\text{C}$ | |
| I_{GES} | Gate-to-Emitter Leakage Current | — | — | ± 100 | nA | $V_{GE} = \pm 20 V$ | |

Switching Characteristics @ $T_J = 25^\circ\text{C}$ (unless otherwise specified)

| | Parameter | Min. | Typ. | Max. | Units | Conditions | Ref.Fig |
|--------------|--------------------------------------|-------------|------|------|---------|--|----------------|
| Q_g | Total Gate Charge (turn-on) | — | 9 | 13 | nC | $I_C = 4A$ $V_{CC} = 400V$ $V_{GE} = 15V$ | 24 |
| Q_{ge} | Gate-to-Emitter Charge (turn-on) | — | 2 | 3 | | | CT1 |
| Q_{gc} | Gate-to-Collector Charge (turn-on) | — | 4 | 6 | | | |
| E_{on} | Turn-On Switching Loss | — | 35 | 77 | μJ | $I_C = 4A, V_{CC} = 400V, V_{GE} = 15V$ $R_G = 100\Omega, L = 1mH, L_S = 150nH, T_J = 25^\circ\text{C}$ Energy losses include tail and diode reverse recovery | CT4 |
| E_{off} | Turn-Off Switching Loss | — | 75 | 118 | | | |
| E_{total} | Total Switching Loss | — | 110 | 196 | | | |
| $t_{d(on)}$ | Turn-On delay time | — | 25 | 33 | ns | $I_C = 4A, V_{CC} = 400V$ $R_G = 100\Omega, L = 1mH, L_S = 150nH$ $T_J = 25^\circ\text{C}$ | CT4 |
| t_r | Rise time | — | 10 | 14 | | | |
| $t_{d(off)}$ | Turn-Off delay time | — | 65 | 75 | | | |
| t_f | Fall time | — | 15 | 20 | | | |
| E_{on} | Turn-On Switching Loss | — | 90 | — | μJ | $I_C = 4A, V_{CC} = 400V, V_{GE} = 15V$ $R_G = 100\Omega, L = 1mH, L_S = 150nH, T_J = 175^\circ\text{C}$ Energy losses include tail and diode reverse recovery | 13,15 |
| E_{off} | Turn-Off Switching Loss | — | 120 | — | | | CT4 |
| E_{total} | Total Switching Loss | — | 210 | — | | | WF1,WF2 |
| $t_{d(on)}$ | Turn-On delay time | — | 20 | — | ns | $I_C = 4A, V_{CC} = 400V$ $R_G = 100\Omega, L = 1mH, L_S = 150nH$ $T_J = 175^\circ\text{C}$ | 14,16 |
| t_r | Rise time | — | 15 | — | | | CT4 |
| $t_{d(off)}$ | Turn-Off delay time | — | 85 | — | | | WF1,WF2 |
| t_f | Fall time | — | 35 | — | | | |
| C_{ies} | Input Capacitance | — | 240 | — | pF | $V_{GE} = 0V$ $V_{CC} = 30V$ $f = 1Mhz$ | 22 |
| C_{oes} | Output Capacitance | — | 25 | — | | | |
| C_{res} | Reverse Transfer Capacitance | — | 10 | — | | | |
| RBSOA | Reverse Bias Safe Operating Area | FULL SQUARE | | | | $T_J = 175^\circ\text{C}, I_C = 16A$ $V_{CC} = 480V, V_p = 600V$ $R_g = 100\Omega, V_{GE} = +15V$ to 0V | 4 CT2 |
| SCSOA | Short Circuir Safe Operating Area | 5 | | | μs | $V_{CC} = 400V, V_p = 600V$ $R_G = 100\Omega, V_{GE} = +15V$ to 0V | 22, CT3 WF4 |
| E_{rec} | Reverse recovery energy of the diode | | 145 | | μJ | $T_J = 175^\circ\text{C}$ | 17,18,19 |
| t_{rr} | Diode Reverse recovery time | | 55 | | ns | $V_{CC} = 400V, I_F = 4A$ | 20,21 |
| I_{rr} | Peak Reverse Recovery Current | | 11 | | A | $V_{GE} = 15V, R_g = 100\Omega, L = 1mH, L_S = 150nH$ | WF3 |

Notes:

- ① $V_{CC} = 80\% (V_{CES}), V_{GE} = 15V, L = 100 \mu H, R_G = 100 \Omega$.
- ② Pulse width limited by max. junction temperature.
- ③ R_θ is measured at T_J approximately 90°C
- ④ Refer to AN-1086 for guide lines for measuring $V_{(BR)CES}$ safely

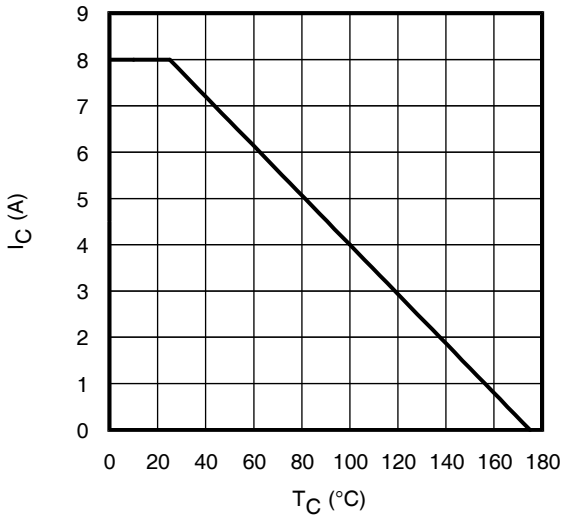

Fig. 1 - Maximum DC Collector Current vs. Case Temperature

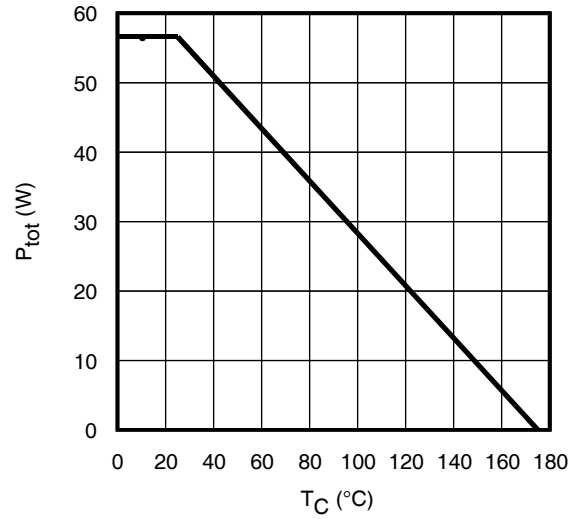

Fig. 2 - Power Dissipation vs. Case Temperature

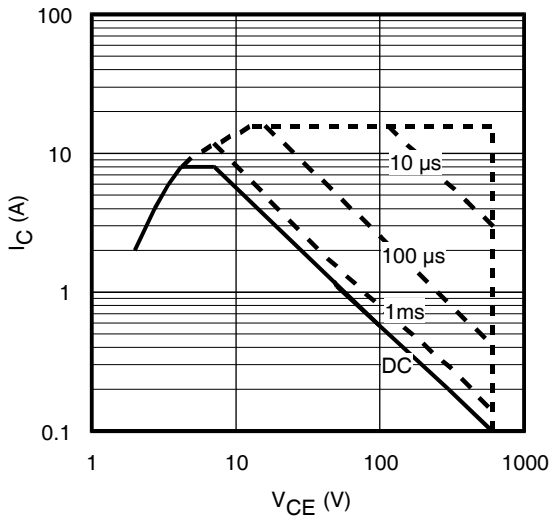

Fig. 3 - Forward SOA,
 $T_C = 25^\circ\text{C}$; $T_J \leq 175^\circ\text{C}$

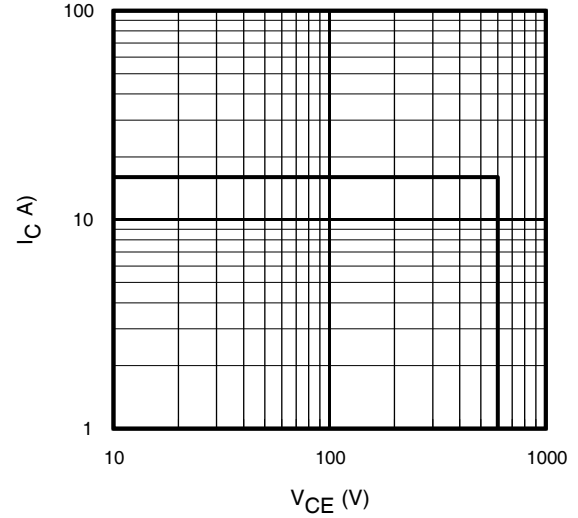

Fig. 4 - Reverse Bias SOA
 $T_J = 175^\circ\text{C}$; $V_{CE} = 15\text{V}$

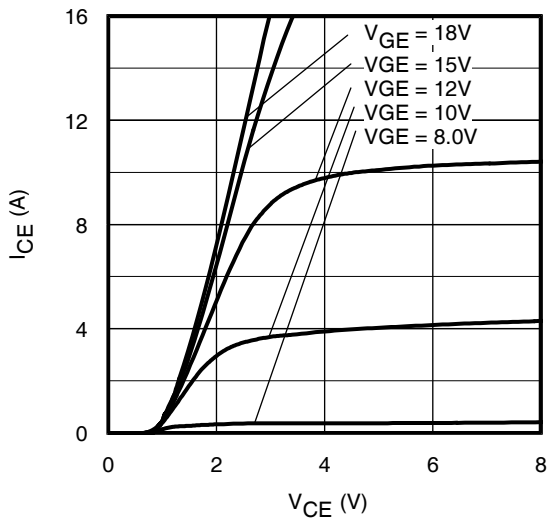

Fig. 5 - Typ. IGBT Output Characteristics
 $T_J = -40^\circ\text{C}$; $t_p = 80\mu\text{s}$

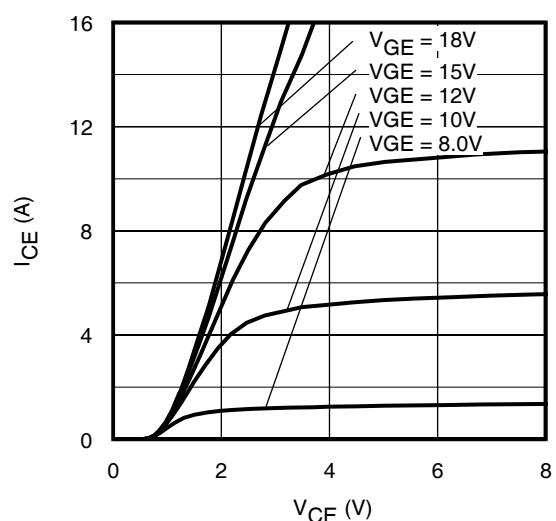

Fig. 6 - Typ. IGBT Output Characteristics
 $T_J = 25^\circ\text{C}$; $t_p = 80\mu\text{s}$

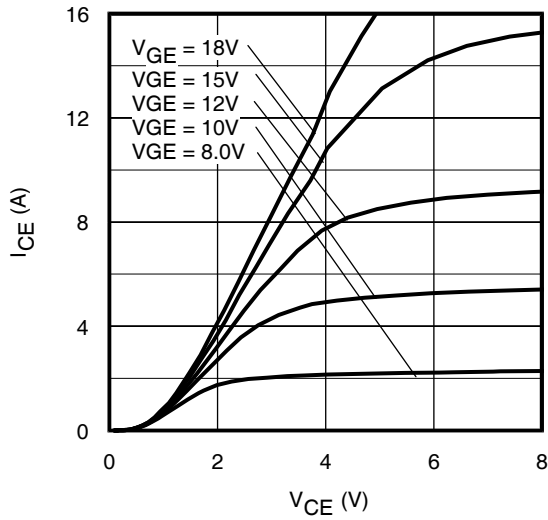

Fig. 7 - Typ. IGBT Output Characteristics
 $T_J = 175^\circ\text{C}$; $t_p = 80\mu\text{s}$

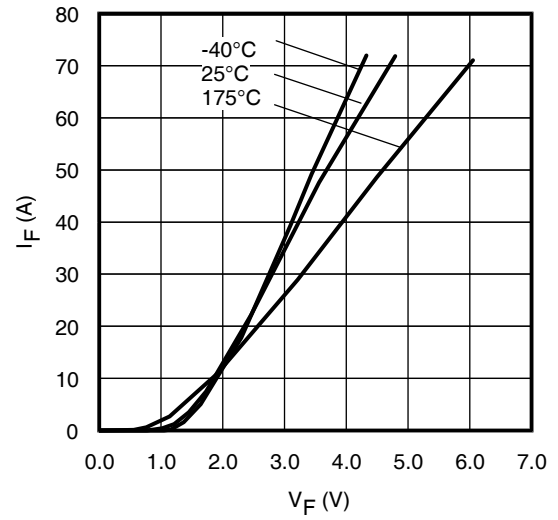

Fig. 8 - Typ. Diode Forward Characteristics
 $t_p = 80\mu\text{s}$

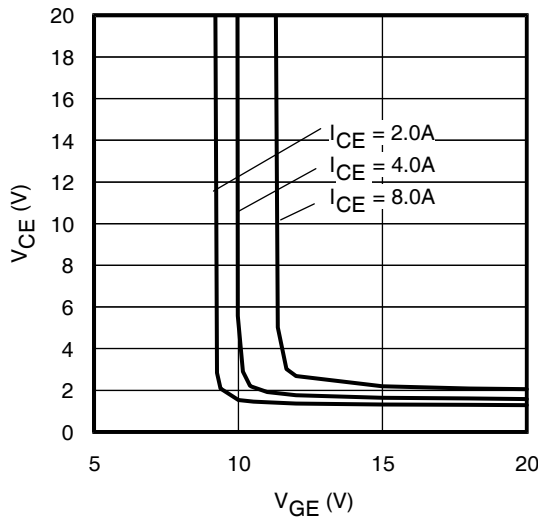

Fig. 9 - Typical V_{CE} vs. V_{GE}
 $T_J = -40^\circ\text{C}$

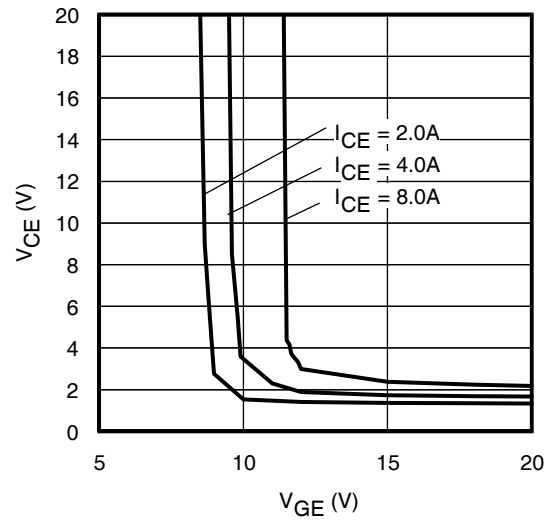

Fig. 10 - Typical V_{CE} vs. V_{GE}
 $T_J = 25^\circ\text{C}$

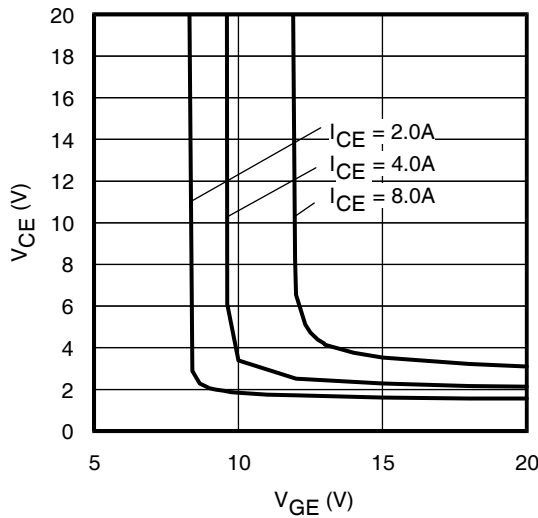

Fig. 11 - Typical V_{CE} vs. V_{GE}
 $T_J = 175^\circ\text{C}$

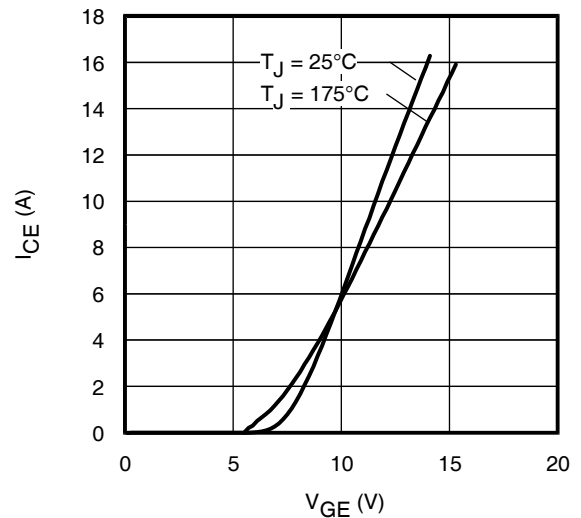

Fig. 12 - Typ. Transfer Characteristics
 $V_{CE} = 50\text{V}$; $t_p = 10\mu\text{s}$

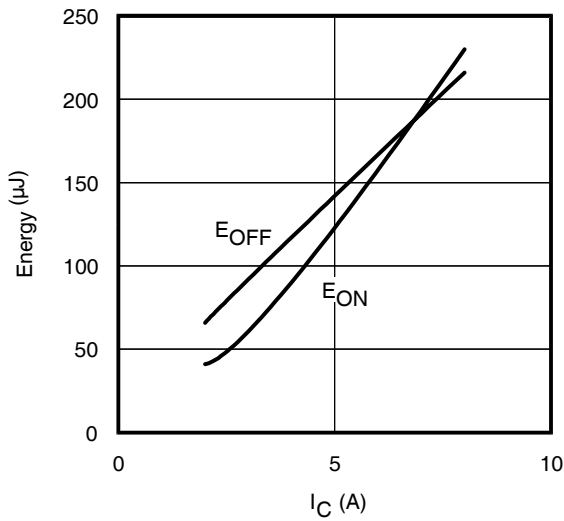

Fig. 13 - Typ. Energy Loss vs. I_C

$T_J = 175^\circ\text{C}$; $L = 1\text{mH}$; $V_{CE} = 400\text{V}$; $R_G = 100\Omega$; $V_{GE} = 15\text{V}$.

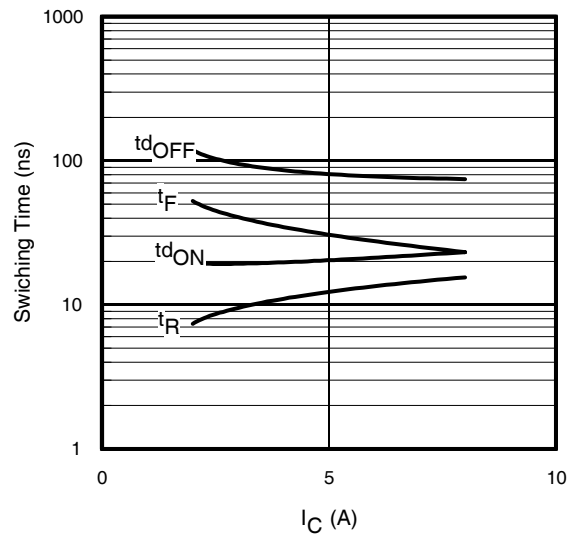

Fig. 14 - Typ. Switching Time vs. I_C

$T_J = 175^\circ\text{C}$; $L = 1\text{mH}$; $V_{CE} = 400\text{V}$
 $R_G = 100\Omega$; $V_{GE} = 15\text{V}$

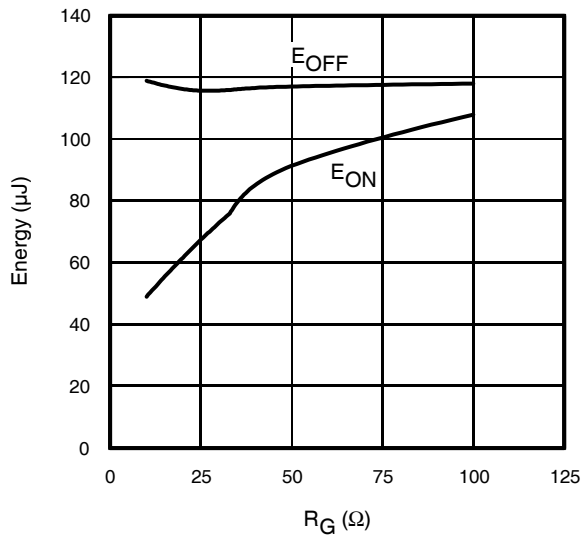

Fig. 15 - Typ. Energy Loss vs. R_G

$T_J = 175^\circ\text{C}$; $L = 1\text{mH}$; $V_{CE} = 400\text{V}$; $I_{CE} = 4\text{A}$; $V_{GE} = 15\text{V}$

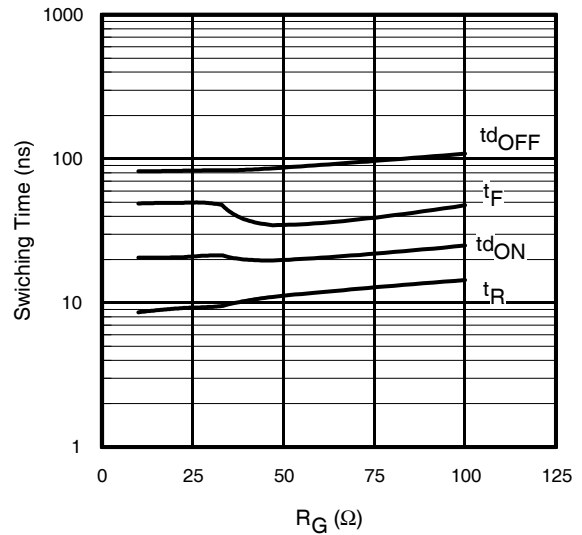

Fig. 16 - Typ. Switching Time vs. R_G

$T_J = 175^\circ\text{C}$; $L = 1\text{mH}$; $V_{CE} = 400\text{V}$
 $I_{CE} = 4\text{A}$; $V_{GE} = 15\text{V}$

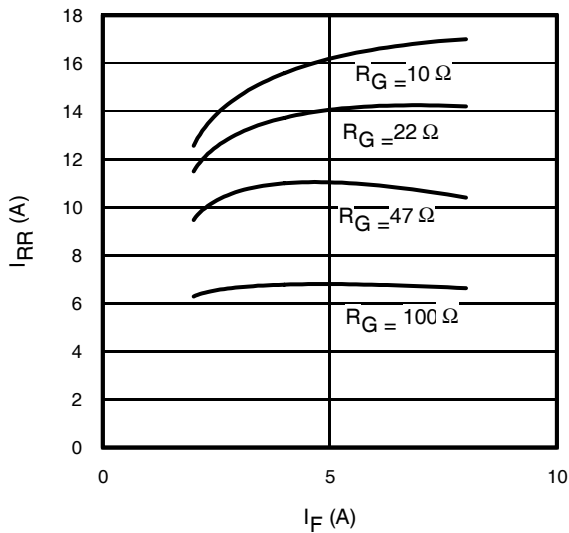

Fig. 17 - Typical Diode I_{RR} vs. I_F

$T_J = 175^\circ\text{C}$

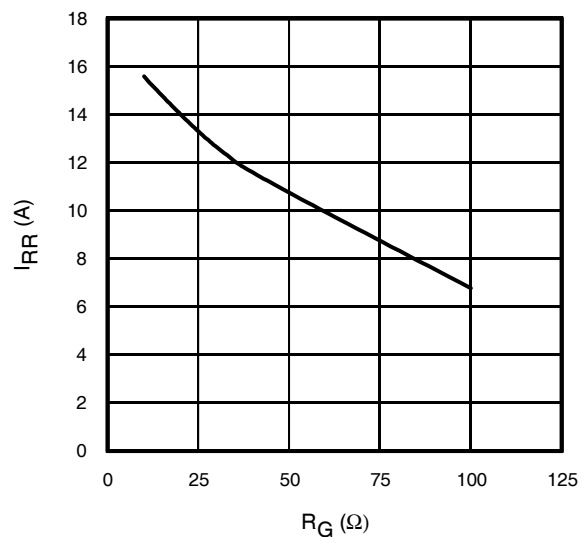

Fig. 18 - Typical Diode I_{RR} vs. R_G

$T_J = 175^\circ\text{C}$; $I_F = 4.0\text{A}$

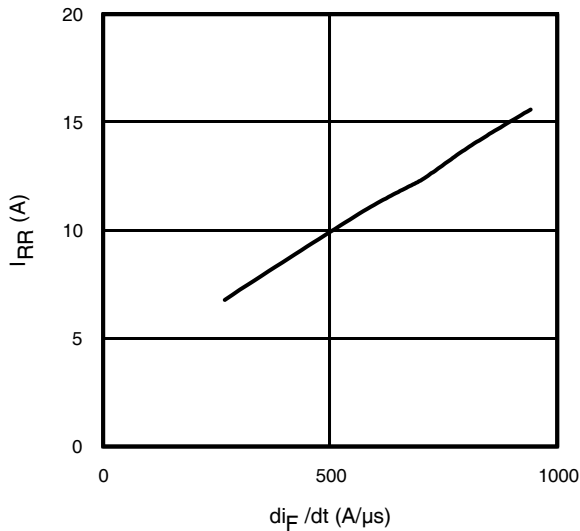

Fig. 19- Typical Diode I_{RR} vs. di_F/dt
 $V_{CC}=400V$; $V_{GE}=15V$;
 $I_{CE}=4A$; $T_J=175^\circ C$

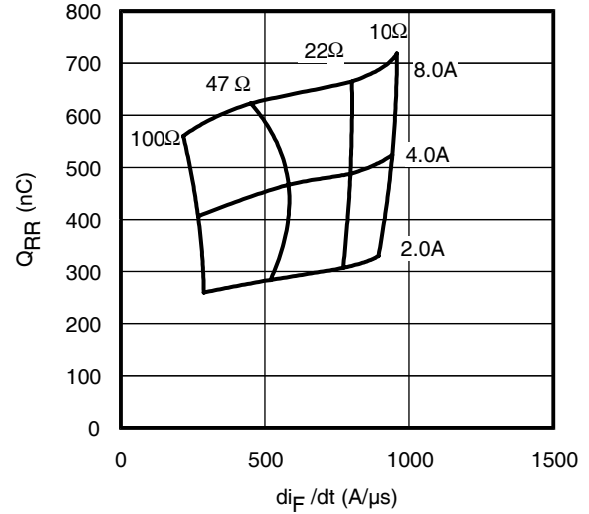

Fig. 20 - Typical Diode Q_{RR}
 $V_{CC}=400V$; $V_{GE}=15V$; $T_J=175^\circ C$

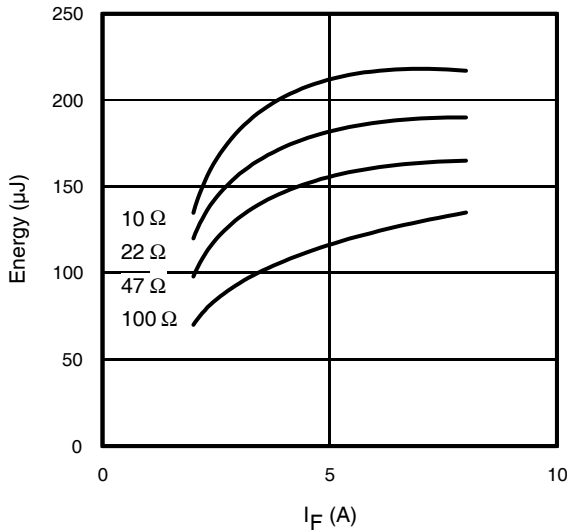

Fig. 21 - Typical Diode E_{RR} vs. I_F
 $T_J=175^\circ C$

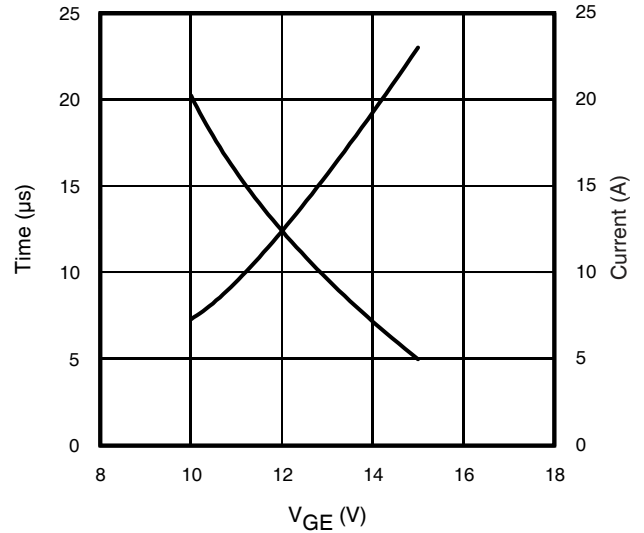

Fig. 22- Typ. V_{GE} vs Short Circuit Time
 $V_{CC}=400V$, $T_C=25^\circ C$

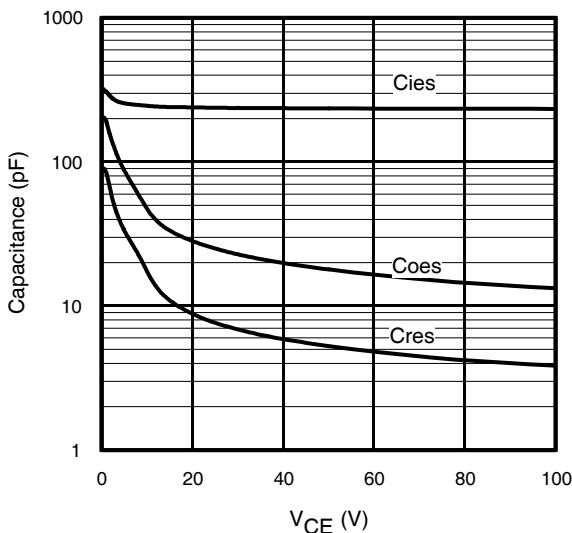

Fig. 23- Typ. Capacitance vs. V_{CE}
 $V_{GE}=0V$; $f=1MHz$

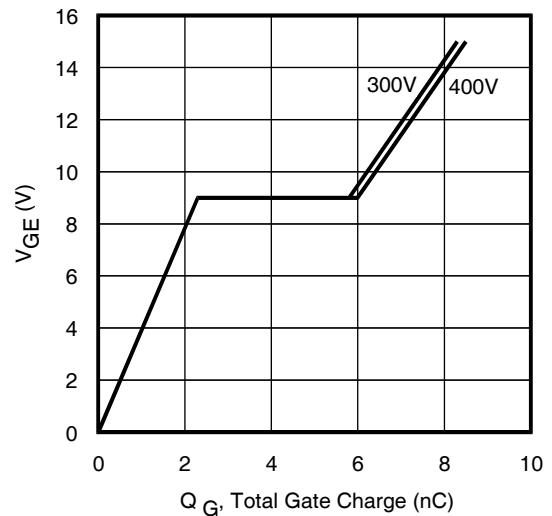

Fig. 24 - Typical Gate Charge vs. V_{GE}
 $I_{CE}=4A$, $L=600\mu H$

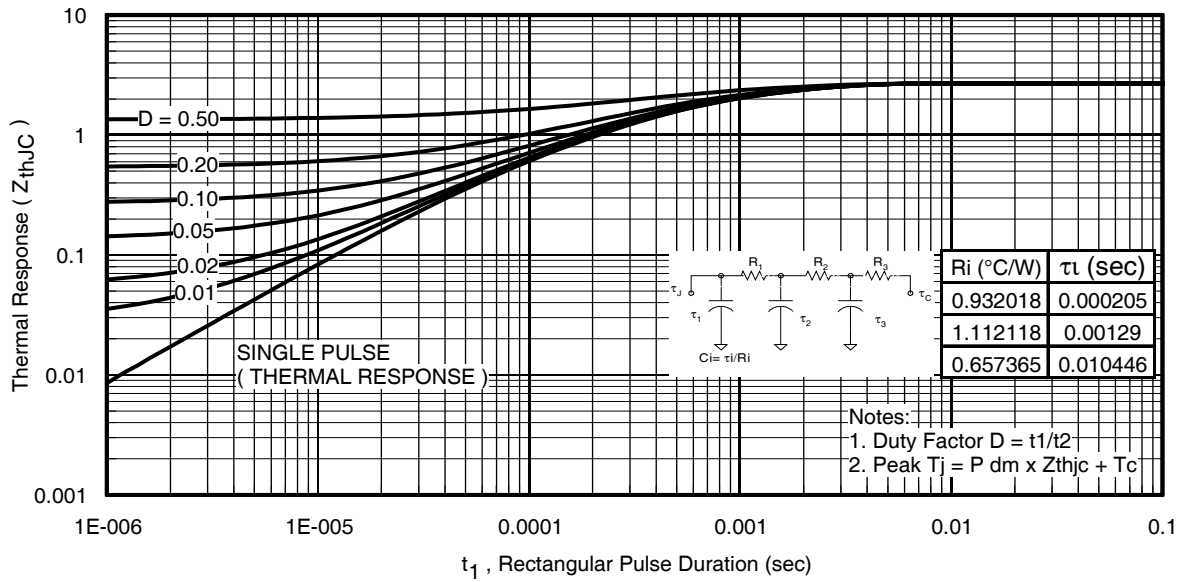

Fig 25. Maximum Transient Thermal Impedance, Junction-to-Case (IGBT)

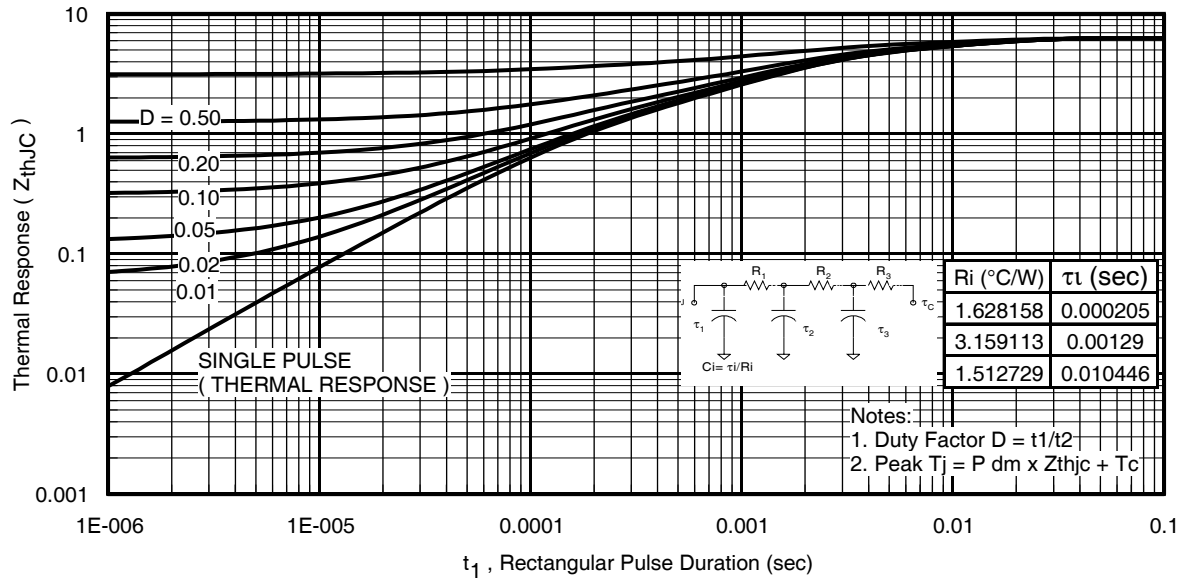

Fig. 26. Maximum Transient Thermal Impedance, Junction-to-Case (DIODE)

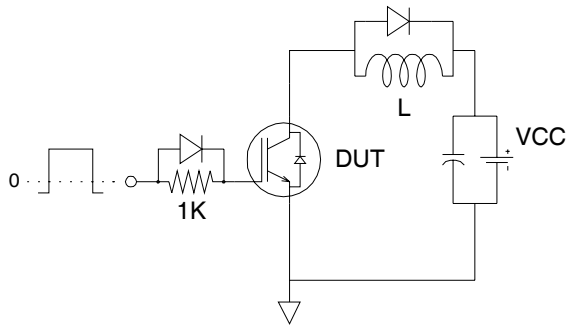

Fig.C.T.1 - Gate Charge Circuit (turn-off)

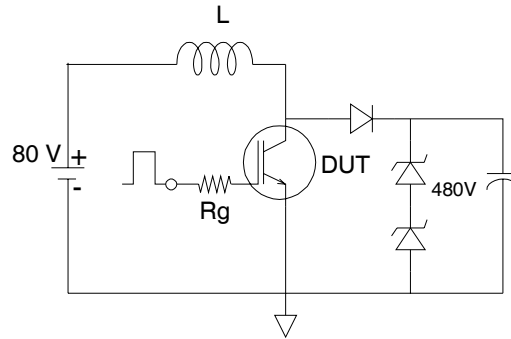

Fig.C.T.2 - RBSOA Circuit

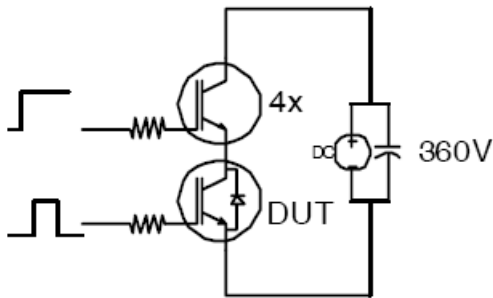

Fig.C.T.3 - S.C.SOA Circuit

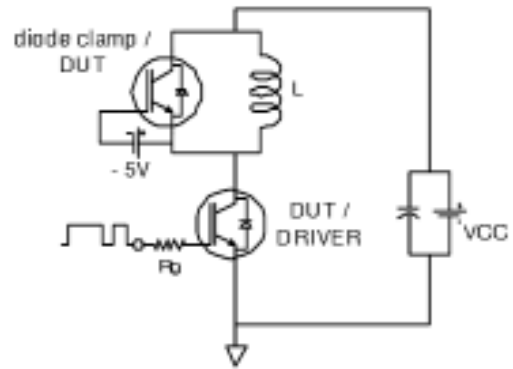

Fig.C.T.4 - Switching Loss Circuit

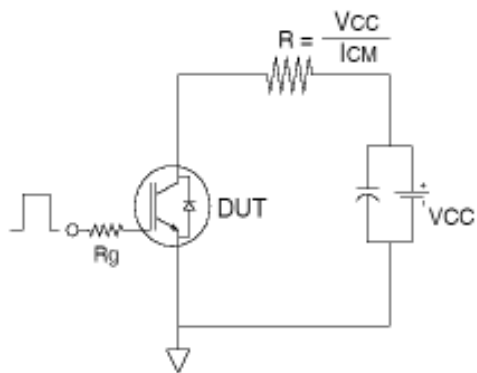

Fig.C.T.5 - Resistive Load Circuit

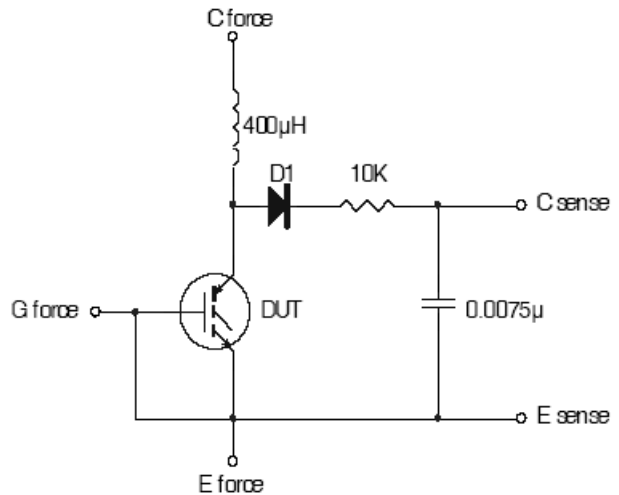

Fig.C.T.6 - Typical Filter Circuit for $V_{(BR)CES}$ Measurement

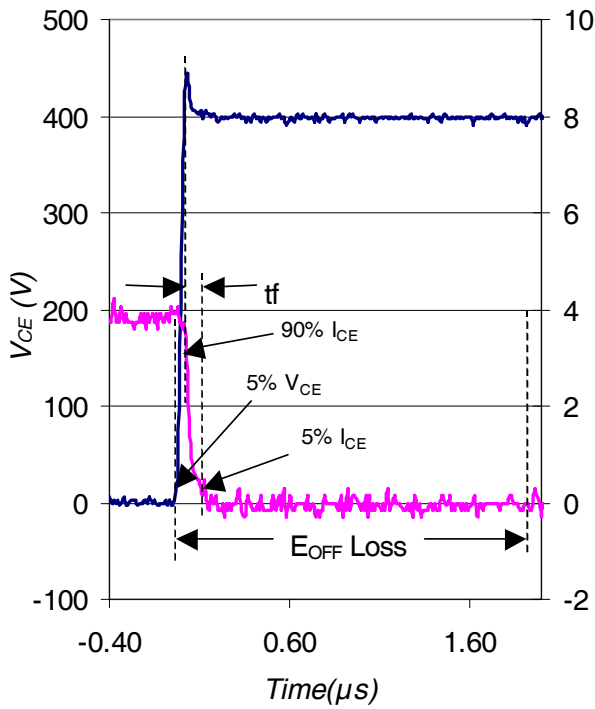

Fig. WF1 - Typ. Turn-off Loss Waveform
@ $T_J = 175^\circ\text{C}$ using Fig. CT.4

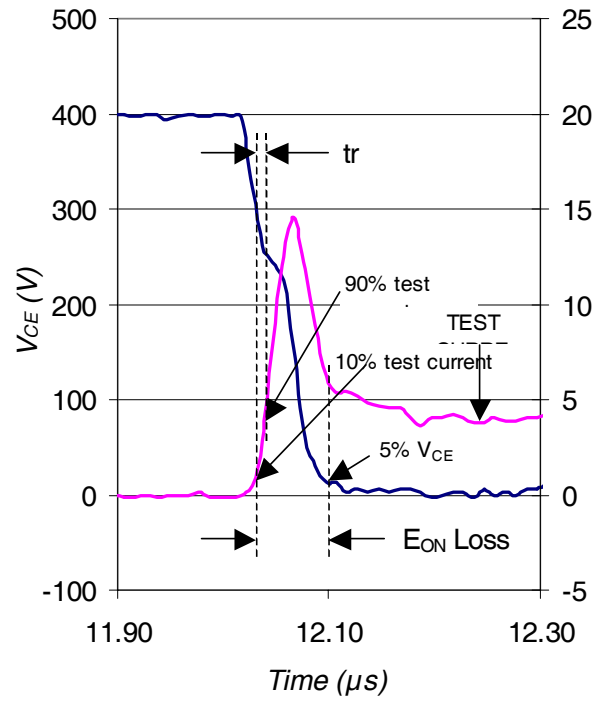
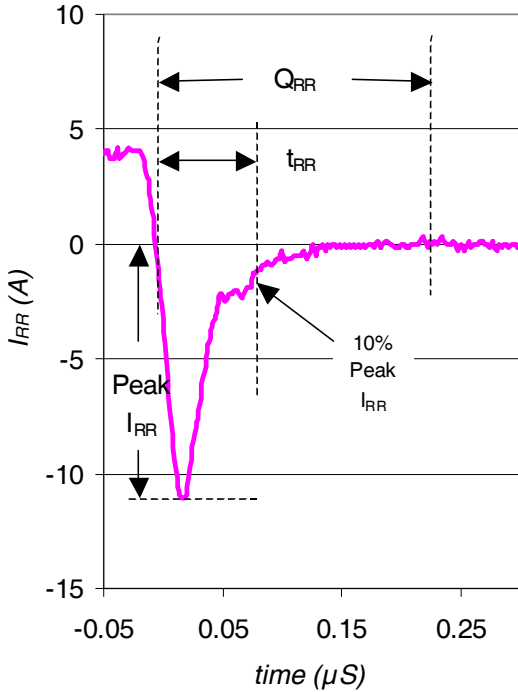
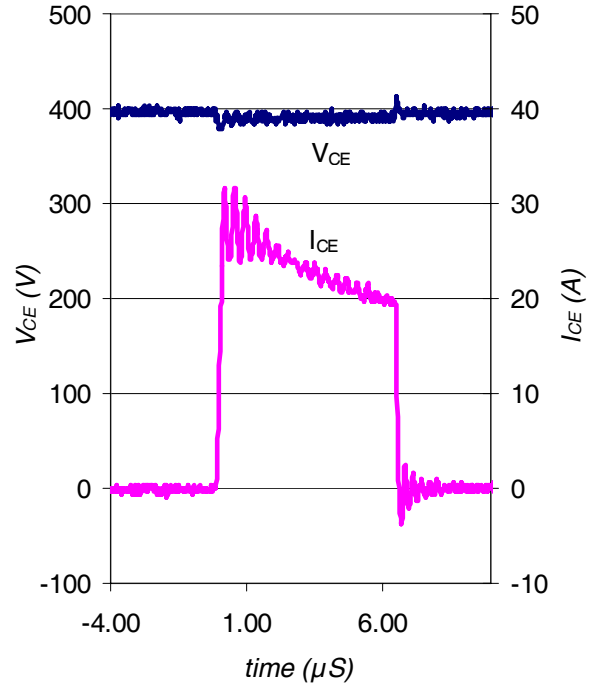

Fig. WF2 - Typ. Turn-on Loss Waveform
@ $T_J = 175^\circ\text{C}$ using Fig. CT.4



WF.3- Typ. Reverse Recovery Waveform
@ $T_J = 175^\circ\text{C}$ using CT.4



WF.4- Typ. Short Circuit Waveform
@ $T_J = 25^\circ\text{C}$ using CT.3

TO-220AB Package Outline (Dimensions are shown in millimeters (inches))

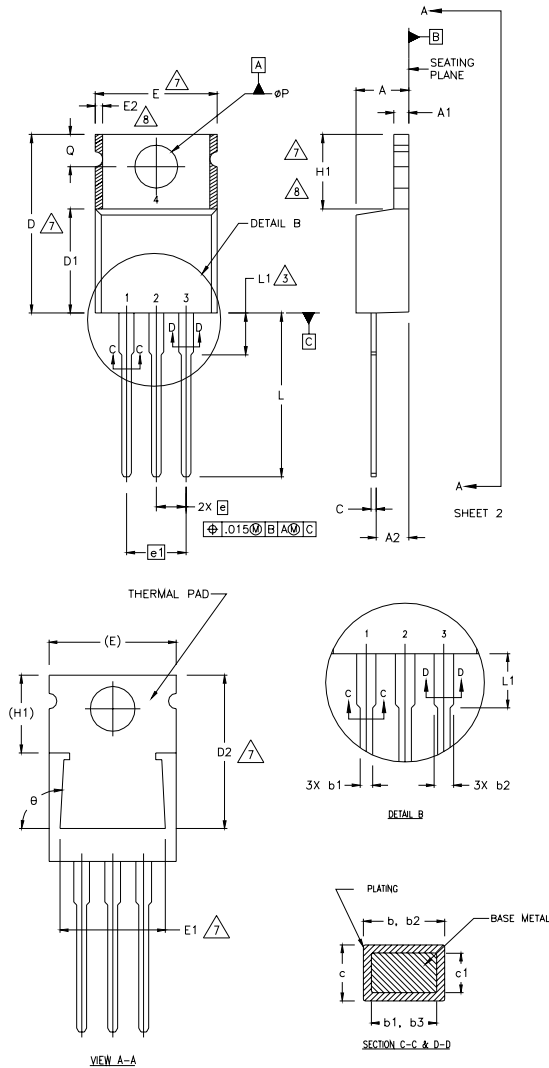

NOTES:

- 1 DIMENSIONING AND TOLERANCING PER ASME Y14.5 M- 1994.
- 2 DIMENSIONS ARE SHOWN IN INCHES [MILLIMETERS].
- 3 LEAD DIMENSION AND FINISH UNCONTROLLED IN L1.
- 4 DIMENSION D & E DO NOT INCLUDE MOLD FLASH. MOLD FLASH SHALL NOT EXCEED .005" (0.127) PER SIDE. THESE DIMENSIONS ARE MEASURED AT THE OUTERMOST EXTREMES OF THE PLASTIC BODY.
- 5 DIMENSION b1 & c1 APPLY TO BASE METAL ONLY.
- 6 CONTROLLING DIMENSION : INCHES.
- 7 THERMAL PAD CONTOUR OPTIONAL WITHIN DIMENSIONS E,H1,D2 & E1
- 8 DIMENSION E2 X H1 DEFINE A ZONE WHERE STAMPING AND SINGULATION IRREGULARITIES ARE ALLOWED.

LEAD ASSIGNMENTS

HEXFET

- 1.- GATE
- 2.- DRAIN
- 3.- SOURCE

IGBTs, CoPACK

- 1.- GATE
- 2.- COLLECTOR
- 3.- EMITTER

DIODES

- 1.- ANODE/OPEN
- 2.- CATHODE
- 3.- ANODE

| SYMBOL | DIMENSIONS | | | | NOTES |
|--------|-------------|-------|----------|------|-------|
| | MILLIMETERS | | INCHES | | |
| | MIN. | MAX. | MIN. | MAX. | |
| A | 3.56 | 4.82 | .140 | .190 | |
| A1 | 0.51 | 1.40 | .020 | .055 | |
| A2 | 2.04 | 2.92 | .080 | .115 | |
| b | 0.38 | 1.01 | .015 | .040 | |
| b1 | 0.38 | 0.96 | .015 | .038 | 5 |
| b2 | 1.15 | 1.77 | .045 | .070 | |
| b3 | 1.15 | 1.73 | .045 | .068 | |
| c | 0.36 | 0.61 | .014 | .024 | |
| c1 | 0.36 | 0.56 | .014 | .022 | 5 |
| D | 14.22 | 16.51 | .560 | .650 | 4 |
| D1 | 8.38 | 9.02 | .330 | .355 | |
| D2 | 12.19 | 12.88 | .480 | .507 | 7 |
| E | 9.66 | 10.66 | .380 | .420 | 4,7 |
| E1 | 8.38 | 8.89 | .330 | .350 | 7 |
| e | 2.54 BSC | | .100 BSC | | |
| e1 | 5.08 | | .200 BSC | | |
| H1 | 5.85 | 6.55 | .230 | .270 | 7,8 |
| L | 12.70 | 14.73 | .500 | .580 | |
| L1 | - | 6.35 | - | .250 | 3 |
| øP | 3.54 | 4.08 | .139 | .161 | |
| Q | 2.54 | 3.42 | .100 | .135 | |
| ø | 90°-93° | | 90°-93° | | |

TO-220AB Part Marking Information

EXAMPLE: THIS IS AN IRF1010
 LOT CODE 1789
 ASSEMBLED ON WW 19, 2000
 IN THE ASSEMBLY LINE "C"

Note: "P" in assembly line position indicates "Lead - Free"

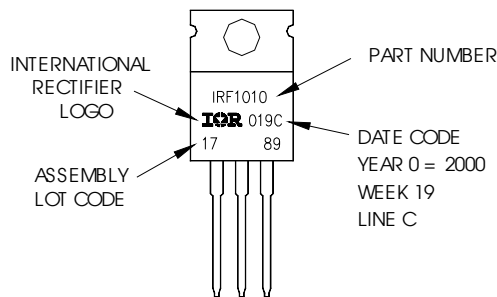

TO-220AB packages are not recommended for Surface Mount Application.

Data and specifications subject to change without notice.
 This product has been designed and qualified for Industrial market.
 Qualification Standards can be found on IR's Web site.

Note: For the most current drawings please refer to the IR website at:
<http://www.irf.com/package/>