

uA78Mxx-Q1 SERIES POSITIVE-VOLTAGE REGULATORS

SLVS537B – JUNE 2004 – REVISED SEPTEMBER 2008

- Qualified for Automotive Applications
- 3-Terminal Regulators
- Output Current Up To 500 mA
- No External Components
- Internal Thermal-Overload Protection
- High Power-Dissipation Capability
- Internal Short-Circuit Current Limiting
- Output Transistor Safe-Area Compensation

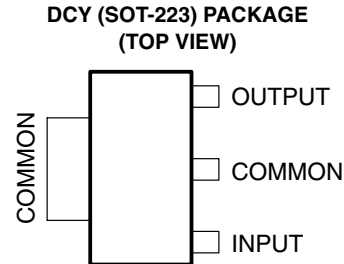
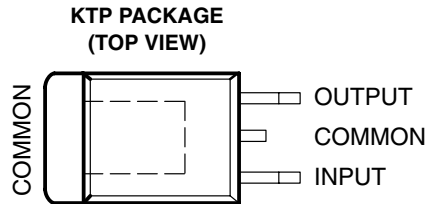

description/ordering information

This series of fixed-voltage integrated-circuit voltage regulators is designed for a wide range of applications. These applications include on-card regulation for elimination of noise and distribution problems associated with single-point regulation. Each of these regulators can deliver up to 500 mA of output current. The internal current-limiting and thermal-shutdown features of these regulators essentially make them immune to overload. In addition to use as fixed-voltage regulators, these devices can be used with external components to obtain adjustable output voltages and currents and also as the power-pass element in precision regulators.

ORDERING INFORMATION[†]

T_J	$V_O(NOM)$ (V)	PACKAGE [‡]		ORDERABLE PART NUMBER	TOP-SIDE MARKING
-40°C to 125°C	3.3	PowerFLEX™ (KTP)	Reel of 3000	UA78M33QKTPRQ1	78M33CQ
		SOT-223 (DCY)	Reel of 2500	UA78M33QDCYRQ1	C3Q
	5	PowerFLEX™ (KTP)	Reel of 3000	UA78M05QKTPRQ1	78M05CQ
		SOT-223 (DCY)	Reel of 2500	UA78M05QDCYRQ1	C5Q
	8	PowerFLEX™ (KTP)	Reel of 3000	UA78M08QKTPRQ1	78M08CQ
		SOT-223 (DCY)	Reel of 2500	UA78M08QDCYRQ1	C8Q
10	PowerFLEX™ (KTP)	Reel of 3000	UA78M10QKTPRQ1	78M10CQ	

[†] For the most current package and ordering information, see the Package Option Addendum at the end of this document, or see the TI web site at www.ti.com.

[‡] Package drawings, thermal data, and symbolization are available at www.ti.com/packaging.



Please be aware that an important notice concerning availability, standard warranty, and use in critical applications of Texas Instruments semiconductor products and disclaimers thereto appears at the end of this data sheet.

PowerFLEX is a trademark of Texas Instruments.

PRODUCTION DATA information is current as of publication date. Products conform to specifications per the terms of Texas Instruments standard warranty. Production processing does not necessarily include testing of all parameters.



POST OFFICE BOX 655303 • DALLAS, TEXAS 75265

Copyright © 2008, Texas Instruments Incorporated

uA78Mxx-Q1 SERIES POSITIVE-VOLTAGE REGULATORS

SLVS537B – JUNE 2004 – REVISED SEPTEMBER 2008

schematic

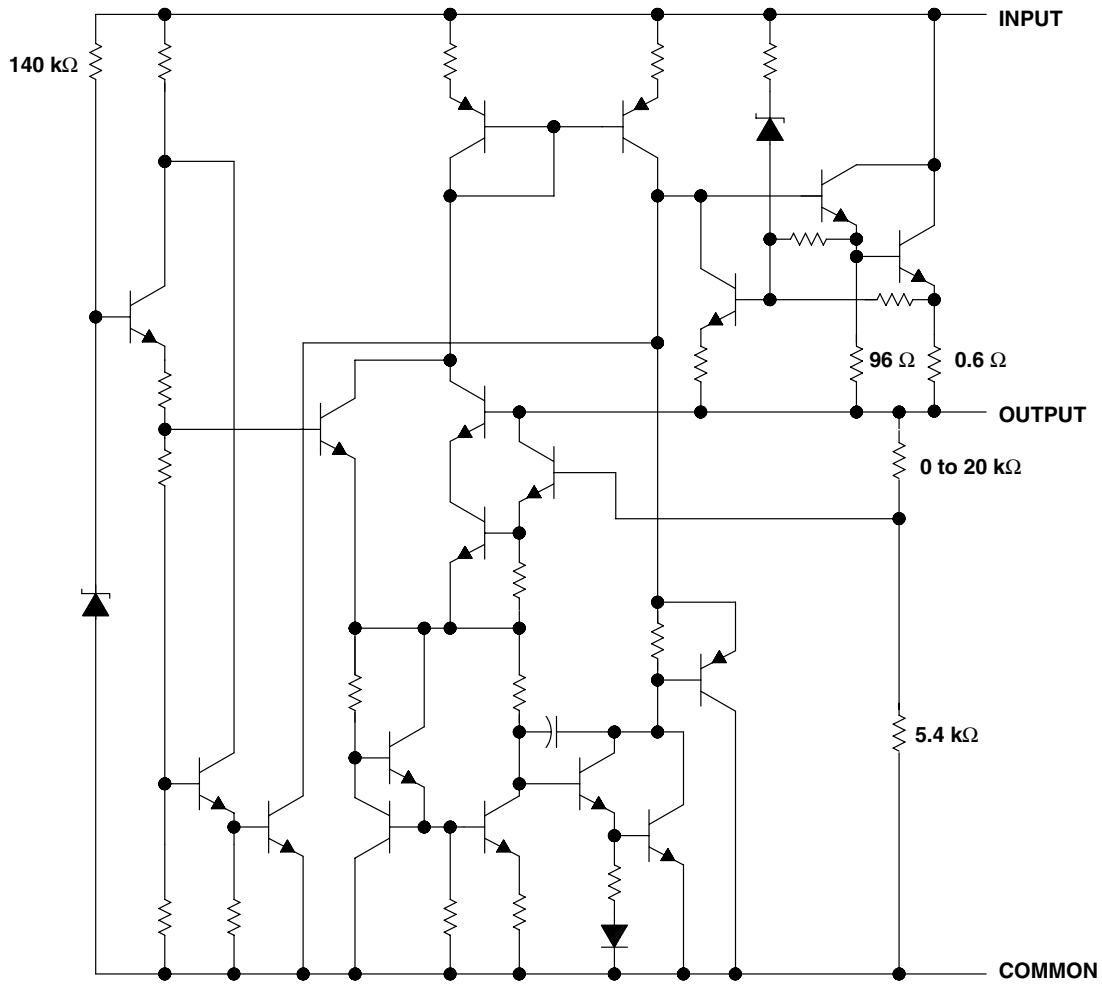

Resistor values shown are nominal.

uA78Mxx-Q1 SERIES POSITIVE-VOLTAGE REGULATORS

SLVS537B – JUNE 2004 – REVISED SEPTEMBER 2008

absolute maximum ratings over virtual junction temperature range (unless otherwise noted)†

Input voltage, V_I	35 V
Operating virtual junction temperature, T_J	150°C
Lead temperature 1,6 mm (1/16 inch) from case for 10 seconds	260°C
Storage temperature range, T_{stg}	–65°C to 150°C

† Stresses beyond those listed under “absolute maximum ratings” may cause permanent damage to the device. These are stress ratings only, and functional operation of the device at these or any other conditions beyond those indicated under “recommended operating conditions” is not implied. Exposure to absolute-maximum-rated conditions for extended periods may affect device reliability.

package thermal data (see Note 1)

PACKAGE	BOARD	θ_{JC}	θ_{JA}
PowerFLEX (KTP)	High K, JESD 51-5	19°C/W	28°C/W
SOT-223 (DCY)	High K, JESD 51-7	4°C/W	53°C/W

NOTE 1: Maximum power dissipation is a function of $T_J(\max)$, θ_{JA} , and T_A . The maximum allowable power dissipation at any allowable ambient temperature is $P_D = (T_J(\max) - T_A)/\theta_{JA}$. Operating at the absolute maximum T_J of 150°C can affect reliability.

recommended operating conditions

		MIN	MAX	UNIT	
V_I	Input voltage	μ A78M33	5.3	25	V
		μ A78M05	7	25	
		μ A78M06	8	25	
		μ A78M08	10.5	25	
		μ A78M09	11.5	26	
		μ A78M10	12.5	28	
		μ A78M12	14.5	30	
I_O	Output current		500	mA	
T_J	Operating virtual junction temperature	–40	125	°C	



μA78Mxx-Q1 SERIES POSITIVE-VOLTAGE REGULATORS

SLVS537B – JUNE 2004 – REVISED SEPTEMBER 2008

electrical characteristics at specified virtual junction temperature, $V_I = 8\text{ V}$, $I_O = 350\text{ mA}$, $T_J = 25^\circ\text{C}$ (unless otherwise noted)

PARAMETER	TEST CONDITIONS†	μA78M33Q			UNIT	
		MIN	TYP	MAX		
Output voltage‡	$I_O = 5\text{ mA to }350\text{ mA}$, $V_I = 8\text{ V to }20\text{ V}$		3.2	3.3	3.4	V
		$T_J = -40^\circ\text{C to }125^\circ\text{C}$	3.1	3.3	3.5	
Input voltage regulation	$I_O = 200\text{ mA}$	$V_I = 5.3\text{ V to }25\text{ V}$		9	100	mV
		$V_I = 8\text{ V to }25\text{ V}$		3	50	
Ripple rejection	$V_I = 8\text{ V to }18\text{ V}$, $f = 120\text{ Hz}$	$I_O = 100\text{ mA}$, $T_J = -40^\circ\text{C to }125^\circ\text{C}$	62			dB
		$I_O = 300\text{ mA}$	62	80		
Output voltage regulation	$V_I = 8\text{ V}$, $I_O = 5\text{ mA to }500\text{ mA}$		20	100	mV	
Temperature coefficient of output voltage	$I_O = 5\text{ mA}$, $T_J = -40^\circ\text{C to }125^\circ\text{C}$		-1		mV/°C	
Output noise voltage	$f = 10\text{ Hz to }100\text{ kHz}$		40	200	μV	
Dropout voltage			2		V	
Bias current			4.5	6	mA	
Bias current change	$I_O = 200\text{ mA}$, $V_I = 8\text{ V to }25\text{ V}$, $T_J = -40^\circ\text{C to }125^\circ\text{C}$				0.8	mA
	$I_O = 5\text{ mA to }350\text{ mA}$, $T_J = -40^\circ\text{C to }125^\circ\text{C}$				0.5	
Short-circuit output current	$V_I = 35\text{ V}$		300		mA	
Peak output current			700		mA	

† All characteristics are measured with a 0.33-μF capacitor across the input and a 0.1-μF capacitor across the output. Pulse-testing techniques maintain T_J as close to T_A as possible. Thermal effects must be taken into account separately.

‡ This specification applies only for dc power dissipation permitted by absolute maximum ratings.

electrical characteristics at specified virtual junction temperature, $V_I = 10\text{ V}$, $I_O = 350\text{ mA}$, $T_J = 25^\circ\text{C}$ (unless otherwise noted)

PARAMETER	TEST CONDITIONS†	μA78M05Q			UNIT	
		MIN	TYP	MAX		
Output voltage	$I_O = 5\text{ mA to }350\text{ mA}$, $V_I = 7\text{ V to }20\text{ V}$		4.8	5	5.2	V
		$T_J = -40^\circ\text{C to }125^\circ\text{C}$	4.75		5.25	
Input voltage regulation	$I_O = 200\text{ mA}$	$V_I = 7\text{ V to }25\text{ V}$		3	100	mV
		$V_I = 8\text{ V to }25\text{ V}$		1	50	
Ripple rejection	$V_I = 8\text{ V to }18\text{ V}$, $f = 120\text{ Hz}$	$I_O = 100\text{ mA}$, $T_J = -40^\circ\text{C to }125^\circ\text{C}$	62			dB
		$I_O = 300\text{ mA}$	62	80		
Output voltage regulation	$I_O = 5\text{ mA to }500\text{ mA}$		20	100	mV	
	$I_O = 5\text{ mA to }200\text{ mA}$		10	50		
Temperature coefficient of output voltage	$I_O = 5\text{ mA}$, $T_J = -40^\circ\text{C to }125^\circ\text{C}$		-1		mV/°C	
Output noise voltage	$f = 10\text{ Hz to }100\text{ kHz}$		40	200	μV	
Dropout voltage			2		V	
Bias current			4.5	6	mA	
Bias current change	$I_O = 200\text{ mA}$, $V_I = 8\text{ V to }25\text{ V}$, $T_J = -40^\circ\text{C to }125^\circ\text{C}$				0.8	mA
	$I_O = 5\text{ mA to }350\text{ mA}$, $T_J = -40^\circ\text{C to }125^\circ\text{C}$				0.5	
Short-circuit output current	$V_I = 35\text{ V}$		300		mA	
Peak output current			0.7		A	

† All characteristics are measured with a 0.33-μF capacitor across the input and a 0.1-μF capacitor across the output. Pulse-testing techniques maintain T_J as close to T_A as possible. Thermal effects must be taken into account separately.



POST OFFICE BOX 655303 • DALLAS, TEXAS 75265

uA78Mxx-Q1 SERIES POSITIVE-VOLTAGE REGULATORS

SLVS537B – JUNE 2004 – REVISED SEPTEMBER 2008

electrical characteristics at specified virtual junction temperature, $V_I = 14\text{ V}$, $I_O = 350\text{ mA}$, $T_J = 25^\circ\text{C}$ (unless otherwise noted)

PARAMETER	TEST CONDITIONS†		μA78M08Q			UNIT
			MIN	TYP	MAX	
Output voltage	$V_I = 10.5\text{ V to }23\text{ V}$, $I_O = 5\text{ mA to }350\text{ mA}$	$T_J = -40^\circ\text{C to }125^\circ\text{C}$	7.7	8	8.3	V
			7.6		8.4	
Input voltage regulation	$I_O = 200\text{ mA}$	$V_I = 10.5\text{ V to }25\text{ V}$		6	100	mV
		$V_I = 11\text{ V to }25\text{ V}$		2	50	
Ripple rejection	$V_I = 11.5\text{ V to }21.5\text{ V}$, $f = 120\text{ Hz}$	$I_O = 100\text{ mA}$, $T_J = -40^\circ\text{C to }125^\circ\text{C}$	56			dB
		$I_O = 300\text{ mA}$	56	80		
Output voltage regulation	$I_O = 5\text{ mA to }500\text{ mA}$			25	160	mV
	$I_O = 5\text{ mA to }200\text{ mA}$			10	80	
Temperature coefficient of output voltage	$I_O = 5\text{ mA}$,	$T_J = -40^\circ\text{C to }125^\circ\text{C}$		-1		mV/°C
Output noise voltage	$f = 10\text{ Hz to }100\text{ kHz}$			52		μV
Dropout voltage				2		V
Bias current				4.6	6	mA
Bias current change	$V_I = 10.5\text{ V to }25\text{ V}$,	$I_O = 200\text{ mA}$,	$T_J = -40^\circ\text{C to }125^\circ\text{C}$		0.8	mA
	$I_O = 5\text{ mA to }350\text{ mA}$,	$T_J = -40^\circ\text{C to }125^\circ\text{C}$			0.5	
Short-circuit output current	$V_I = 35\text{ V}$			250		mA
Peak output current				0.7		A

† All characteristics are measured with a 0.33-μF capacitor across the input and a 0.1-μF capacitor across the output. Pulse-testing techniques maintain T_J as close to T_A as possible. Thermal effects must be taken into account separately.

electrical characteristics at specified virtual junction temperature, $V_I = 17\text{ V}$, $I_O = 350\text{ mA}$, $T_J = 25^\circ\text{C}$ (unless otherwise noted)

PARAMETER	TEST CONDITIONS†		μA78M10Q			UNIT
			MIN	TYP	MAX	
Output voltage	$V_I = 12.5\text{ V to }25\text{ V}$, $I_O = 5\text{ mA to }350\text{ mA}$	$T_J = -40^\circ\text{C to }125^\circ\text{C}$	9.6	10	10.4	V
			9.5		10.5	
Input voltage regulation	$I_O = 200\text{ mA}$	$V_I = 12.5\text{ V to }28\text{ V}$		7	100	mV
		$V_I = 14\text{ V to }28\text{ V}$		2	50	
Ripple rejection	$V_I = 15\text{ V to }25\text{ V}$, $f = 120\text{ Hz}$	$I_O = 100\text{ mA}$, $T_J = -40^\circ\text{C to }125^\circ\text{C}$	59			dB
		$I_O = 300\text{ mA}$	55	80		
Output voltage regulation	$I_O = 5\text{ mA to }500\text{ mA}$			25	200	mV
	$I_O = 5\text{ mA to }200\text{ mA}$			10	100	
Temperature coefficient of output voltage	$I_O = 5\text{ mA}$,	$T_J = -40^\circ\text{C to }125^\circ\text{C}$		-1		mV/°C
Output noise voltage	$f = 10\text{ Hz to }100\text{ kHz}$			64		μV
Dropout voltage				2		V
Bias current				4.7	6	mA
Bias current change	$V_I = 12.5\text{ V to }28\text{ V}$,	$I_O = 200\text{ mA}$,	$T_J = -40^\circ\text{C to }125^\circ\text{C}$		0.8	mA
	$I_O = 5\text{ mA to }350\text{ mA}$,	$T_J = -40^\circ\text{C to }125^\circ\text{C}$			0.5	
Short-circuit output current	$V_I = 35\text{ V}$			245		mA
Peak output current				0.7		A

† All characteristics are measured with a 0.33-μF capacitor across the input and a 0.1-μF capacitor across the output. Pulse-testing techniques maintain T_J as close to T_A as possible. Thermal effects must be taken into account separately.



PACKAGING INFORMATION

Orderable Device	Status (1)	Package Type	Package Drawing	Pins	Package Qty	Eco Plan (2)	Lead finish/ Ball material (6)	MSL Peak Temp (3)	Op Temp (°C)	Device Marking (4/5)	Samples
UA78M05QDCYRG4Q1	ACTIVE	SOT-223	DCY	4	2500	RoHS & Green	NIPDAU	Level-2-260C-1 YEAR	-40 to 125	C5Q	Samples
UA78M05QDCYRQ1	ACTIVE	SOT-223	DCY	4	2500	RoHS & Green	NIPDAU	Level-2-260C-1 YEAR	-40 to 125	C5Q	Samples
UA78M33QDCYRG4Q1	ACTIVE	SOT-223	DCY	4	2500	RoHS & Green	NIPDAU	Level-2-260C-1 YEAR	-40 to 125	C3Q	Samples

(1) The marketing status values are defined as follows:

ACTIVE: Product device recommended for new designs.

LIFEBUY: TI has announced that the device will be discontinued, and a lifetime-buy period is in effect.

NRND: Not recommended for new designs. Device is in production to support existing customers, but TI does not recommend using this part in a new design.

PREVIEW: Device has been announced but is not in production. Samples may or may not be available.

OBSOLETE: TI has discontinued the production of the device.

(2) **RoHS:** TI defines "RoHS" to mean semiconductor products that are compliant with the current EU RoHS requirements for all 10 RoHS substances, including the requirement that RoHS substance do not exceed 0.1% by weight in homogeneous materials. Where designed to be soldered at high temperatures, "RoHS" products are suitable for use in specified lead-free processes. TI may reference these types of products as "Pb-Free".

RoHS Exempt: TI defines "RoHS Exempt" to mean products that contain lead but are compliant with EU RoHS pursuant to a specific EU RoHS exemption.

Green: TI defines "Green" to mean the content of Chlorine (Cl) and Bromine (Br) based flame retardants meet JS709B low halogen requirements of <=1000ppm threshold. Antimony trioxide based flame retardants must also meet the <=1000ppm threshold requirement.

(3) MSL, Peak Temp. - The Moisture Sensitivity Level rating according to the JEDEC industry standard classifications, and peak solder temperature.

(4) There may be additional marking, which relates to the logo, the lot trace code information, or the environmental category on the device.

(5) Multiple Device Markings will be inside parentheses. Only one Device Marking contained in parentheses and separated by a "~" will appear on a device. If a line is indented then it is a continuation of the previous line and the two combined represent the entire Device Marking for that device.

(6) Lead finish/Ball material - Orderable Devices may have multiple material finish options. Finish options are separated by a vertical ruled line. Lead finish/Ball material values may wrap to two lines if the finish value exceeds the maximum column width.

Important Information and Disclaimer:The information provided on this page represents TI's knowledge and belief as of the date that it is provided. TI bases its knowledge and belief on information provided by third parties, and makes no representation or warranty as to the accuracy of such information. Efforts are underway to better integrate information from third parties. TI has taken and continues to take reasonable steps to provide representative and accurate information but may not have conducted destructive testing or chemical analysis on incoming materials and chemicals. TI and TI suppliers consider certain information to be proprietary, and thus CAS numbers and other limited information may not be available for release.

In no event shall TI's liability arising out of such information exceed the total purchase price of the TI part(s) at issue in this document sold by TI to Customer on an annual basis.

OTHER QUALIFIED VERSIONS OF UA78M-Q1 :

- Catalog : [UA78M](#)

NOTE: Qualified Version Definitions:

- Catalog - TI's standard catalog product

TAPE AND REEL INFORMATION

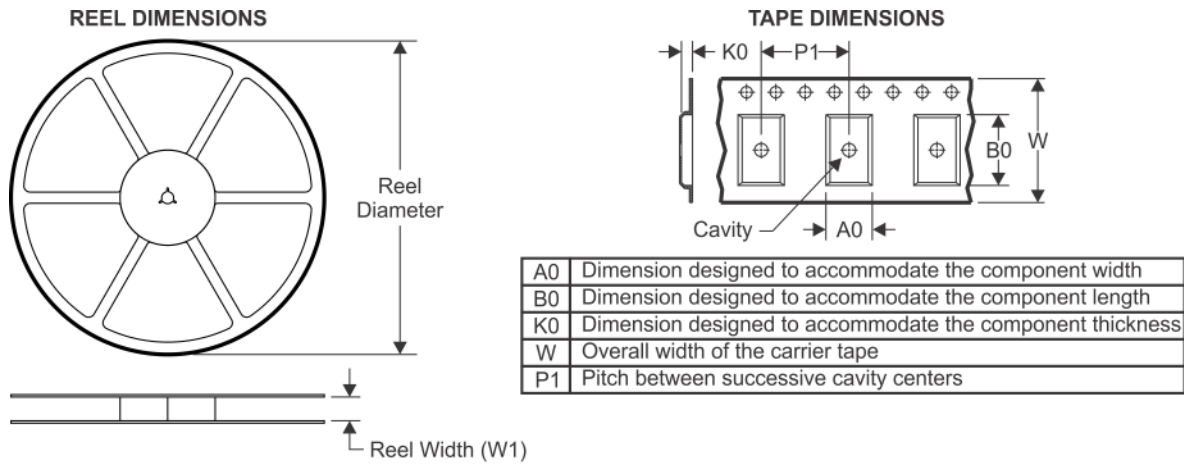

QUADRANT ASSIGNMENTS FOR PIN 1 ORIENTATION IN TAPE

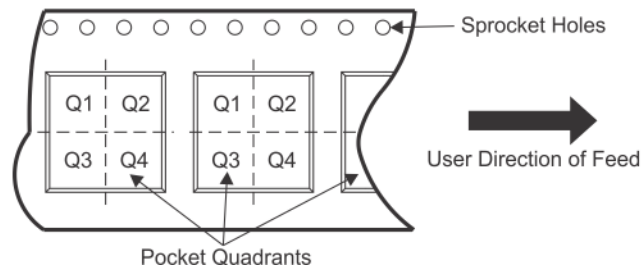

*All dimensions are nominal

Device	Package Type	Package Drawing	Pins	SPQ	Reel Diameter (mm)	Reel Width W1 (mm)	A0 (mm)	B0 (mm)	K0 (mm)	P1 (mm)	W (mm)	Pin1 Quadrant
UA78M05QDCYRG4Q1	SOT-223	DCY	4	2500	330.0	12.4	6.8	7.3	1.88	8.0	12.0	Q3
UA78M33QDCYRG4Q1	SOT-223	DCY	4	2500	330.0	12.4	6.83	7.42	1.88	8.0	12.0	Q3

TAPE AND REEL BOX DIMENSIONS

*All dimensions are nominal

Device	Package Type	Package Drawing	Pins	SPQ	Length (mm)	Width (mm)	Height (mm)
UA78M05QDCYRG4Q1	SOT-223	DCY	4	2500	346.0	346.0	29.0
UA78M33QDCYRG4Q1	SOT-223	DCY	4	2500	346.0	346.0	29.0

DCY (R-PDSO-G4)

PLASTIC SMALL-OUTLINE

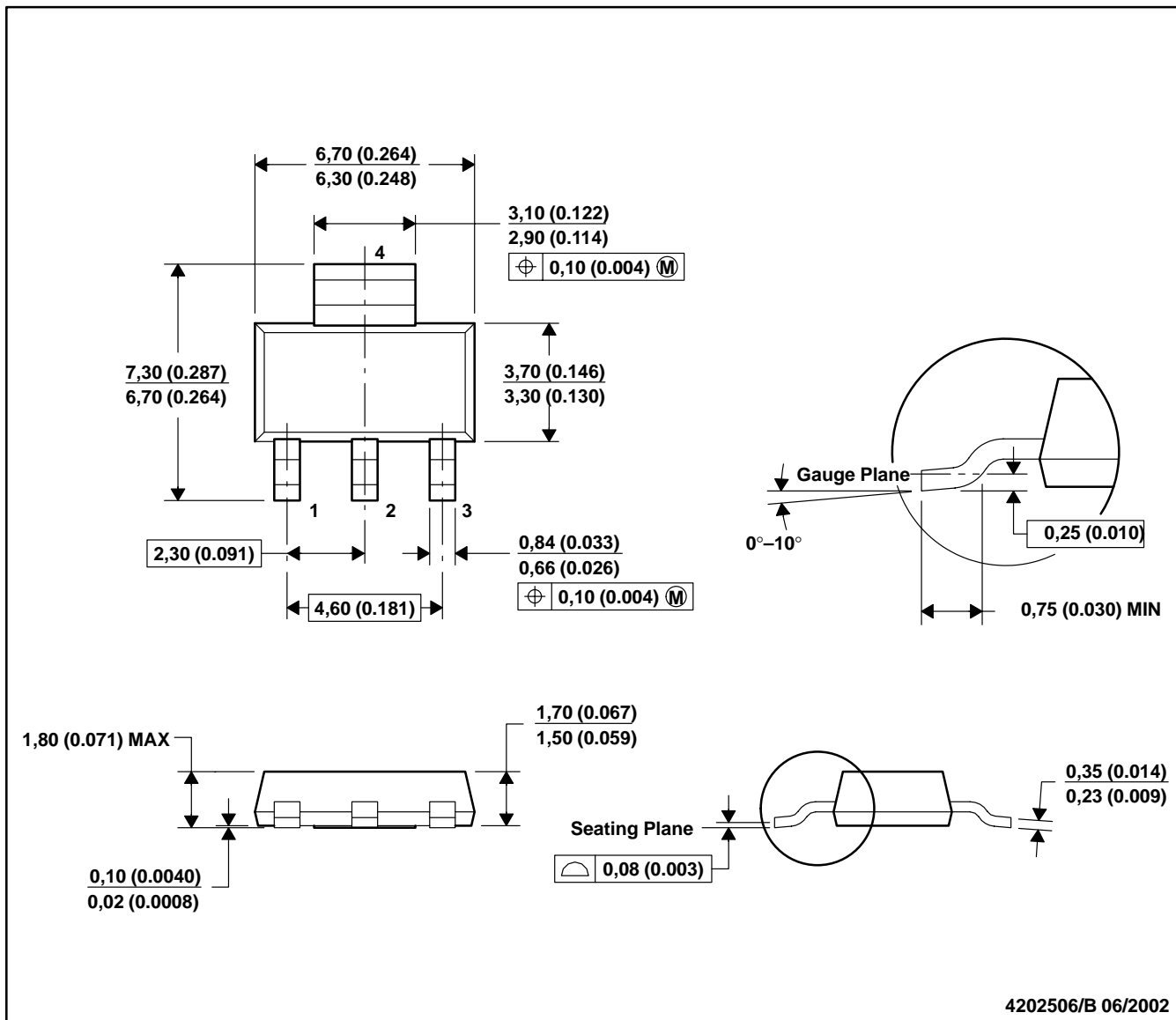

- NOTES: A. All linear dimensions are in millimeters (inches).
 B. This drawing is subject to change without notice.
 C. Body dimensions do not include mold flash or protrusion.
 D. Falls within JEDEC TO-261 Variation AA.

DCY (R-PDSO-G4)

PLASTIC SMALL OUTLINE

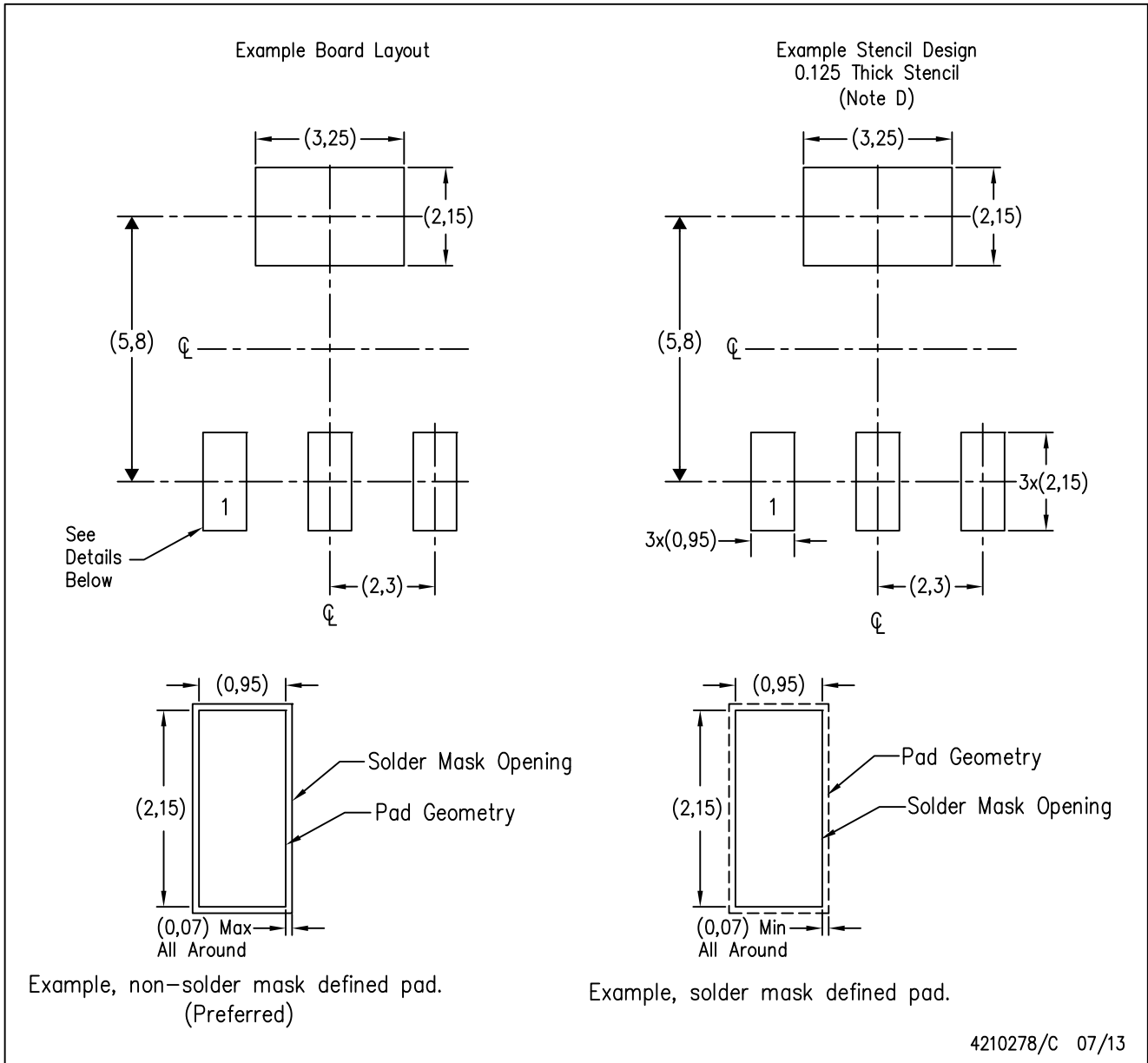

- NOTES:
- A. All linear dimensions are in millimeters.
 - B. This drawing is subject to change without notice.
 - C. Publication IPC-7351 is recommended for alternate designs.
 - D. Laser cutting apertures with trapezoidal walls and also rounding corners will offer better paste release. Customers should contact their board assembly site for stencil recommendations. Refer to IPC 7525 for stencil design considerations.

IMPORTANT NOTICE AND DISCLAIMER

TI PROVIDES TECHNICAL AND RELIABILITY DATA (INCLUDING DATASHEETS), DESIGN RESOURCES (INCLUDING REFERENCE DESIGNS), APPLICATION OR OTHER DESIGN ADVICE, WEB TOOLS, SAFETY INFORMATION, AND OTHER RESOURCES "AS IS" AND WITH ALL FAULTS, AND DISCLAIMS ALL WARRANTIES, EXPRESS AND IMPLIED, INCLUDING WITHOUT LIMITATION ANY IMPLIED WARRANTIES OF MERCHANTABILITY, FITNESS FOR A PARTICULAR PURPOSE OR NON-INFRINGEMENT OF THIRD PARTY INTELLECTUAL PROPERTY RIGHTS.

These resources are intended for skilled developers designing with TI products. You are solely responsible for (1) selecting the appropriate TI products for your application, (2) designing, validating and testing your application, and (3) ensuring your application meets applicable standards, and any other safety, security, or other requirements. These resources are subject to change without notice. TI grants you permission to use these resources only for development of an application that uses the TI products described in the resource. Other reproduction and display of these resources is prohibited. No license is granted to any other TI intellectual property right or to any third party intellectual property right. TI disclaims responsibility for, and you will fully indemnify TI and its representatives against, any claims, damages, costs, losses, and liabilities arising out of your use of these resources.

TI's products are provided subject to TI's Terms of Sale (<https://www.ti.com/legal/termsofsale.html>) or other applicable terms available either on [ti.com](https://www.ti.com) or provided in conjunction with such TI products. TI's provision of these resources does not expand or otherwise alter TI's applicable warranties or warranty disclaimers for TI products.

Mailing Address: Texas Instruments, Post Office Box 655303, Dallas, Texas 75265
Copyright © 2021, Texas Instruments Incorporated