

Features

Unregulated Converters

- 2W single and dual outputs in DIP14
- 3kVDC/1s or 4kVDC/1s isolation
- Optional continuous short circuit protection
- UL94V-0 package material
- Efficiency up to 85%
- Suitable for IGBT applications



RJZ & RGZ

**2 Watt
DIP14
Single and Dual
Output**

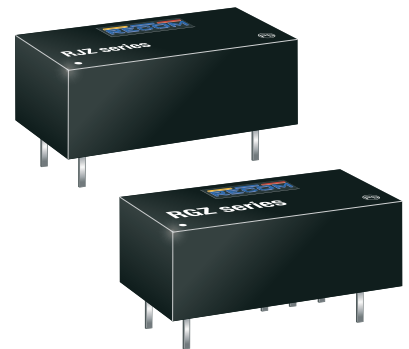

IEC/EN60950-1 certified
IEC/EN60601-1 certified

Description

The RJZ and RGZ series converters are available in DIP14 packages, so can be used for applications where component height is restricted. The wide selection of input voltage and output voltage options plus an I/O-Isolation of 3kVDC or 4kVDC as standard makes these converters suitable for many industrial, medical and IGBT applications.

Selection Guide

| Part Number | nom. Input Voltage [VDC] | Output Voltage [VDC] | Output Current [mA] | Efficiency typ. ⁽¹⁾ [%] | max. Capacitive Load ⁽²⁾ [µF] |
|------------------------------|--------------------------|----------------------|---------------------|------------------------------------|--|
| RJZ-xx3.3S ^(3,4) | 3.3, 5, 9, 12, 15, 24 | 3.3 | 606 | 70-75 | 3300 |
| RJZ-xx05S ^(3,4) | 3.3, 5, 9, 12, 15, 24 | 5 | 400 | 78-85 | 1200 |
| RJZ-xx09S ^(3,4) | 3.3, 5, 9, 12, 15, 24 | 9 | 222 | 78-84 | 1200 |
| RJZ-xx12S ^(3,4) | 3.3, 5, 9, 12, 15, 24 | 12 | 166 | 80-85 | 680 |
| RJZ-xx15S ^(3,4) | 3.3, 5, 9, 12, 15, 24 | 15 | 133 | 82-85 | 680 |
| RJZ-xx24S ^(3,4) | 3.3, 5, 9, 12, 15, 24 | 24 | 83 | 80-85 | 220 |
| RGZ-xx3.3D ^(3,4) | 3.3, 5, 9, 12, 15, 24 | ±3.3 | ±303 | 75 | ±1500 |
| RGZ-xx05D ^(3,4) | 3.3, 5, 9, 12, 15, 24 | ±5 | ±200 | 75-82 | ±470 |
| RGZ-xx09D ^(3,4) | 3.3, 5, 9, 12, 15, 24 | ±9 | ±111 | 75-80 | ±470 |
| RGZ-xx12D ^(3,4) | 3.3, 5, 9, 12, 15, 24 | ±12 | ±84 | 78-82 | ±220 |
| RGZ-xx15D ^(3,4) | 3.3, 5, 9, 12, 15, 24 | ±15 | ±66 | 80-84 | ±220 |
| RGZ-xx24D ^(3,4) | 3.3, 5, 9, 12, 15, 24 | ±24 | ±42 | 82-84 | ±100 |
| RGZ-xx1509D ^(3,4) | 5, 12, 24 | +15/-9 | +67/-111 | 70-81 | ±330 |

Notes:

Note1: Efficiency is tested at nominal input and full load at +25°C ambient

Note2: Max Cap Load is tested at nominal input and full resistive load and is defined as the capacitive load that will allow start up in under 1s without damage to the converter

Model Numbering

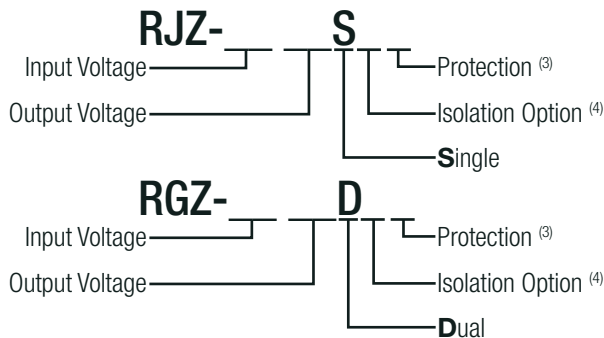

Notes:

Note3: standard part is without continuous short circuit protection
add suffix „/P“ for continuous short circuit protection

Note4: add suffix “/H” for 4kVDC/1s isolation
or add suffix “/HP” for continuous short circuit protection and 4kVDC/1s isolation

Ordering Examples

- RJZ-1212S = 12V Input, 12V Output, Single
- RJZ-0505S/P = 5V Input, 5V Output, Single, continuous short circuit protection
- RGZ-0505D/HP = 5V Input, 5V Output, Dual, 4kVDC/1s isolation and continuous short circuit protection

Specifications (measured @ Ta= 25°C, nom. Vin, full load and after warm-up unless otherwise stated)

BASIC CHARACTERISTICS

| Parameter | Condition | Min. | Typ. | Max. |
|------------------------------|-------------|----------------|----------------|----------|
| Input Voltage Range | | | ±10% | |
| Minimum Load | | 0% | | |
| Internal Operating Frequency | RGZ-xx1509D | 20kHz 20kHz | 50kHz 45kHz | 90kHz |
| Output Ripple and Noise | 20MHz BW | | | 150mVp-p |

Efficiency vs. Load

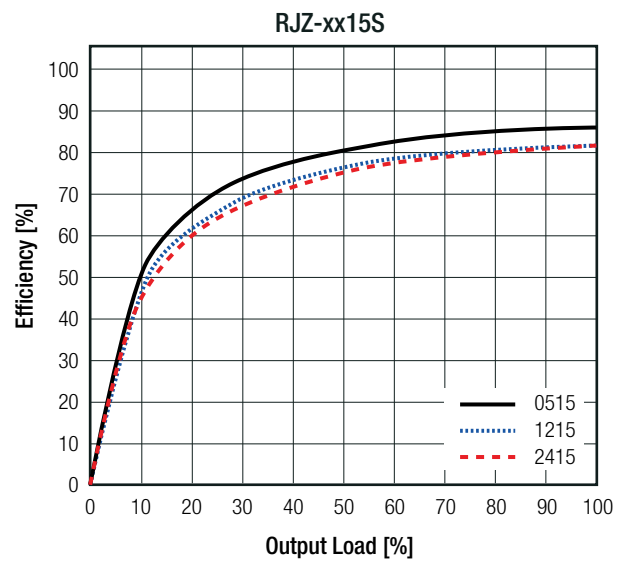
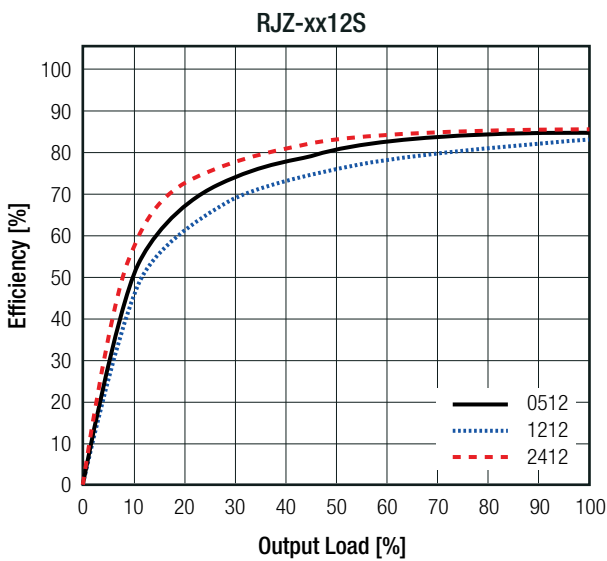
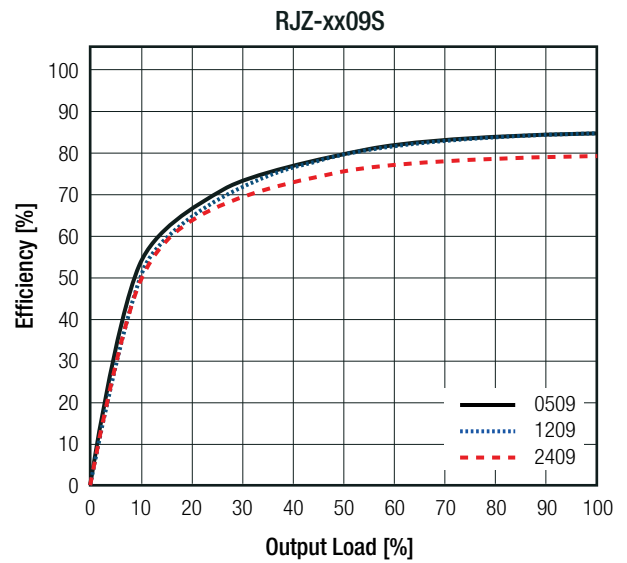
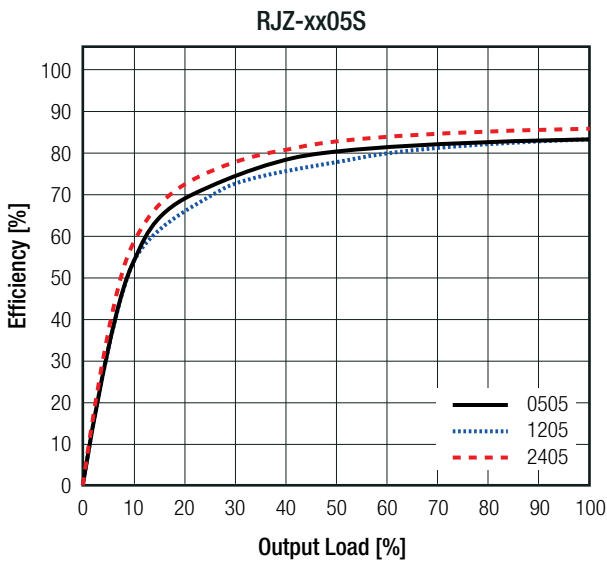

continued on next page

Specifications (measured @ Ta= 25°C, nom. Vin, full load and after warm-up unless otherwise stated)

Efficiency vs. Load

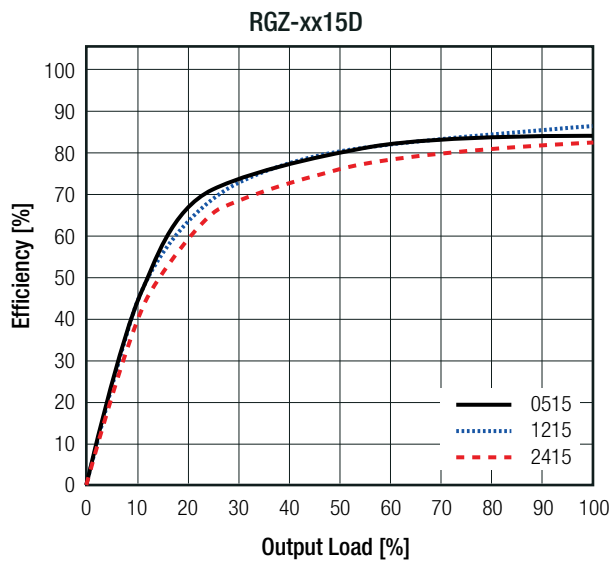
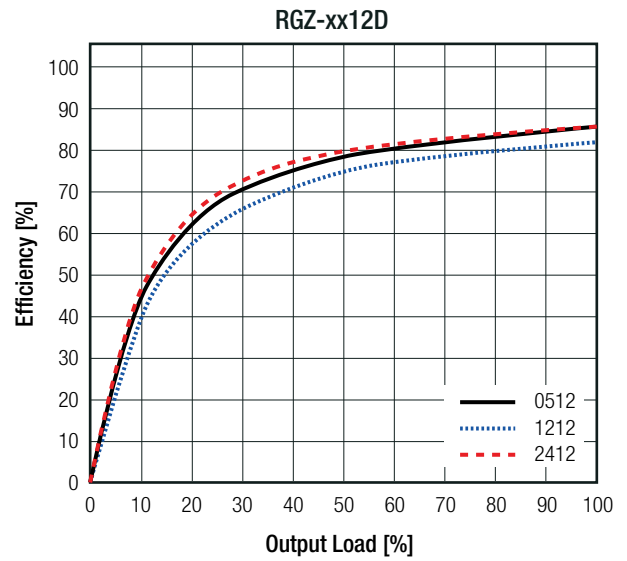
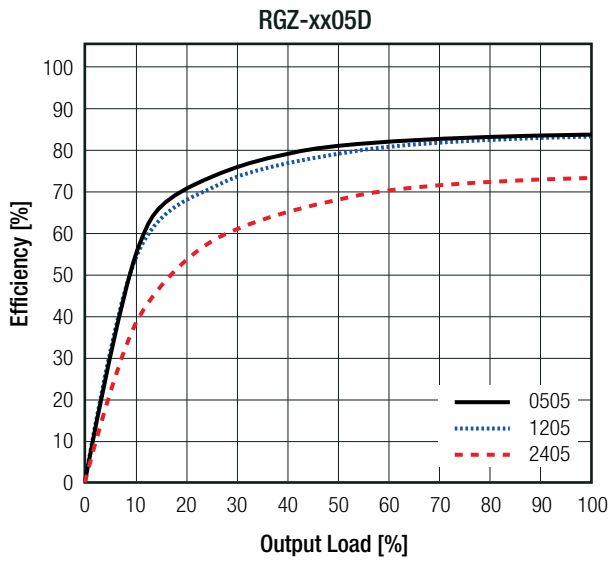

REGULATIONS

| Parameter | Condition | | Value |
|--------------------------------|-----------------------|------------------------------|------------------------|
| Output Accuracy | | | ±5.0% max. |
| Line Regulation | low line to high line | | ±1.2% of 1.0% Vin typ. |
| Load Regulation ⁽⁵⁾ | 10% to 100% load | 3.3Vout | 20.0% max. |
| | | 5Vout | 15.0% max. |
| | | 9, 12, 15, 24 and +15/-9Vout | 10.0% max. |

Notes:

Note5: Operation below 10% load will not harm the converter, but specifications may not be met

continued on next page

Specifications (measured @ Ta= 25°C, nom. Vin, full load and after warm-up unless otherwise stated)

Deviation vs. Load

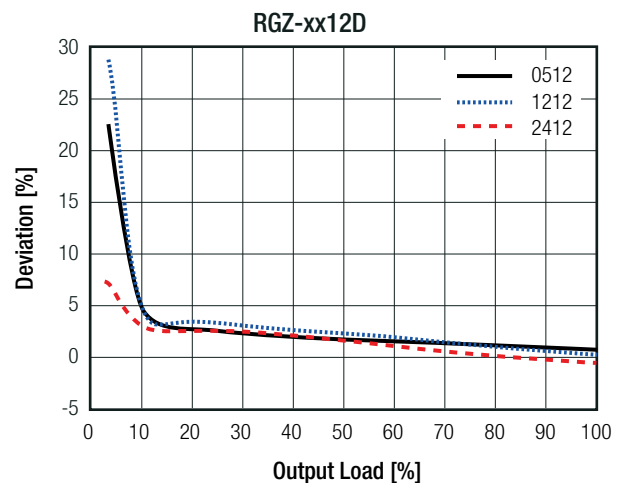
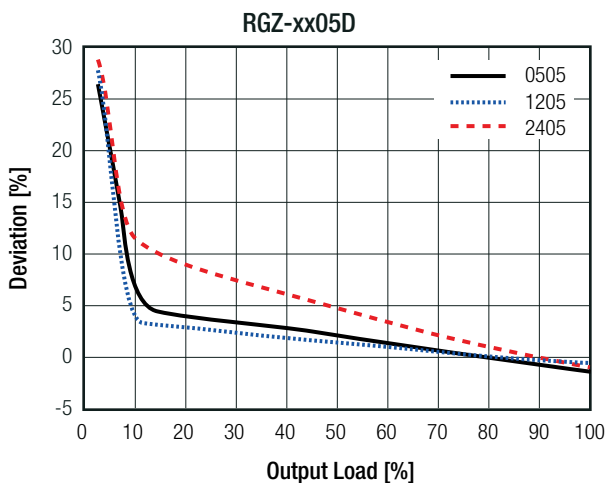
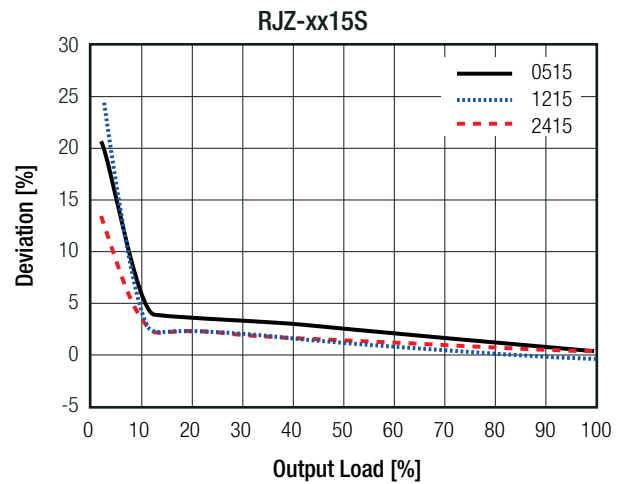
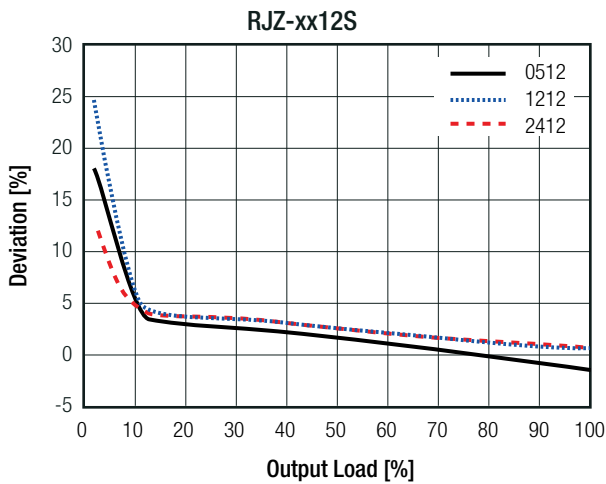
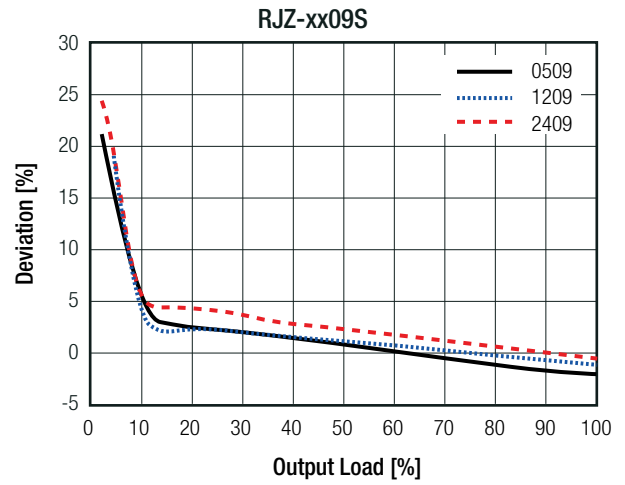
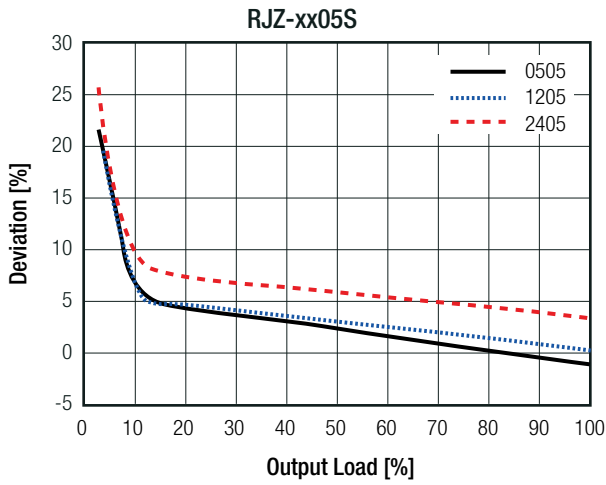

continued on next page

Specifications (measured @ Ta= 25°C, nom. Vin, full load and after warm-up unless otherwise stated)

Deviation vs. Load

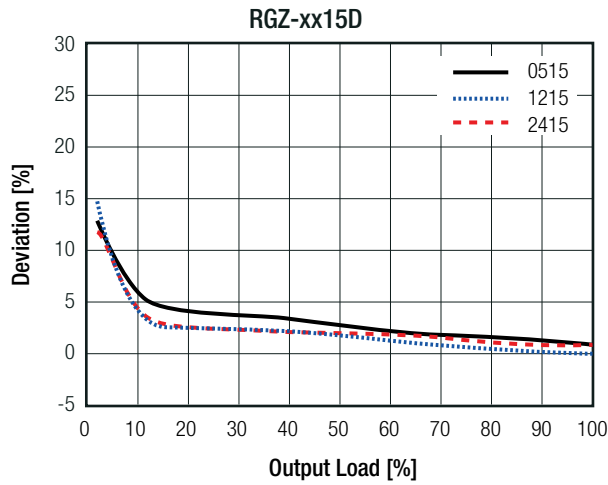

PROTECTIONS

| Parameter | Type | | Value |
|----------------------------------|------------------------------------|---------------------|--|
| Short Circuit Protection (SCP) | without suffix with suffix "/P" | | 1 second continuous |
| Isolation Voltage ⁽⁶⁾ | I/P to O/P | without suffix | tested for 1 second rated for 1 minute 3kVDC 1.5kVAC/60Hz |
| | | with suffix "/H" | tested for 1 second rated for 1 minute 4kVDC 2kVAC/60Hz |
| Isolation Resistance | | | 15GΩ min. |
| Isolation Capacitance | | | 120pF max. |
| Insulation Grade | | | basic (IEC/EN60950-1) functional (IEC/EN60601-1) |

Notes:

Note6: For repeat Hi-Pot testing, reduce the time and/or the test voltage

Note7: Refer to local safety regulations if input over-current protection is required. Recommended fuse: slow blow type

ENVIRONMENTAL

| Parameter | Condition | | Value | |
|-----------------------------|---|-----|----------------|-----------------------------|
| Operating Temperature Range | full load @ free air convection (see graph) | | -40°C to +90°C | |
| Maximum Case Temperature | | | +110°C | |
| Temperature Coefficient | | | ±0.02%/K | |
| Thermal Impedance | 0.1m/s, horizontal | | 56.66K/W | |
| Operating Altitude | | | 2000m | |
| Operating Humidity | non-condensing | | 95% RH max. | |
| Pollution Degree | | | PD2 | |
| MTBF | according to MIL-HDBK-217F, G.B. | RJZ | +25°C | 893 x 10 ³ hours |
| | | | +85°C | 208 x 10 ³ hours |
| | | RGZ | +25°C | 810 x 10 ³ hours |
| | | | +85°C | 151 x 10 ³ hours |

continued on next page

Specifications (measured @ Ta= 25°C, nom. Vin, full load and after warm-up unless otherwise stated)

Derating Graph
(@ free air convection)

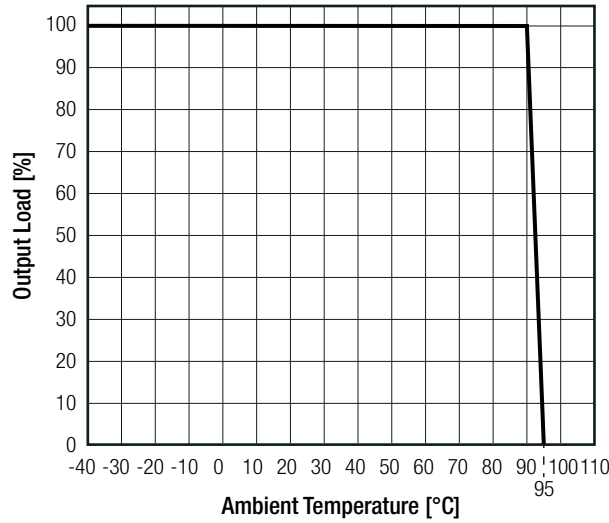

SAFETY AND CERTIFICATIONS

| Certificate Type (Safety) | Report / File Number | Standard |
|--|----------------------------------|---|
| Information Technology Equipment, General Requirements for Safety | SPCLVD1602031 | IEC60950-1:2005, 2nd Edition + A2:2013 EN60950-1:2006 + A2:2013 |
| Information Technology Equipment, General Requirements for Safety | E358085 ⁽⁸⁾ | UL60950-1, 2nd Edition, 2007 CAN/CSA C22.2 NO. 60950-1, 2nd Edition, 2007 |
| Medical electrical equipment Part 1: General requirements for basic safety and essential performance | WD-SE-R-180676-A0 ⁽⁹⁾ | IEC60601-1:2005 + A1:2012, 3rd Edition EN60601-1:2006 + A1:2013 + A12:2014 |
| EAC | RU-AT.49.09571 | TP TC 004/2011 |
| RoHS 2+ | | RoHS-2011/65/EU + AM-2015/863 |

Notes:

- Note8: only +15/-9 version
- Note9: excluded +15/-9 version

DIMENSION AND PHYSICAL CHARACTERISTICS

| Parameter | Type | Value |
|-------------------|------------------------|---|
| Material | case potting PCB | non-conductive black plastic (UL94 V-0) epoxy, (UL94 V-0) FR4, (UL94 V-0) |
| Dimension (LxWxH) | | 19.9 x 10.0 x 7.1mm |
| Weight | | 2.8g typ. |

continued on next page

Specifications (measured @ Ta= 25°C, nom. Vin, full load and after warm-up unless otherwise stated)

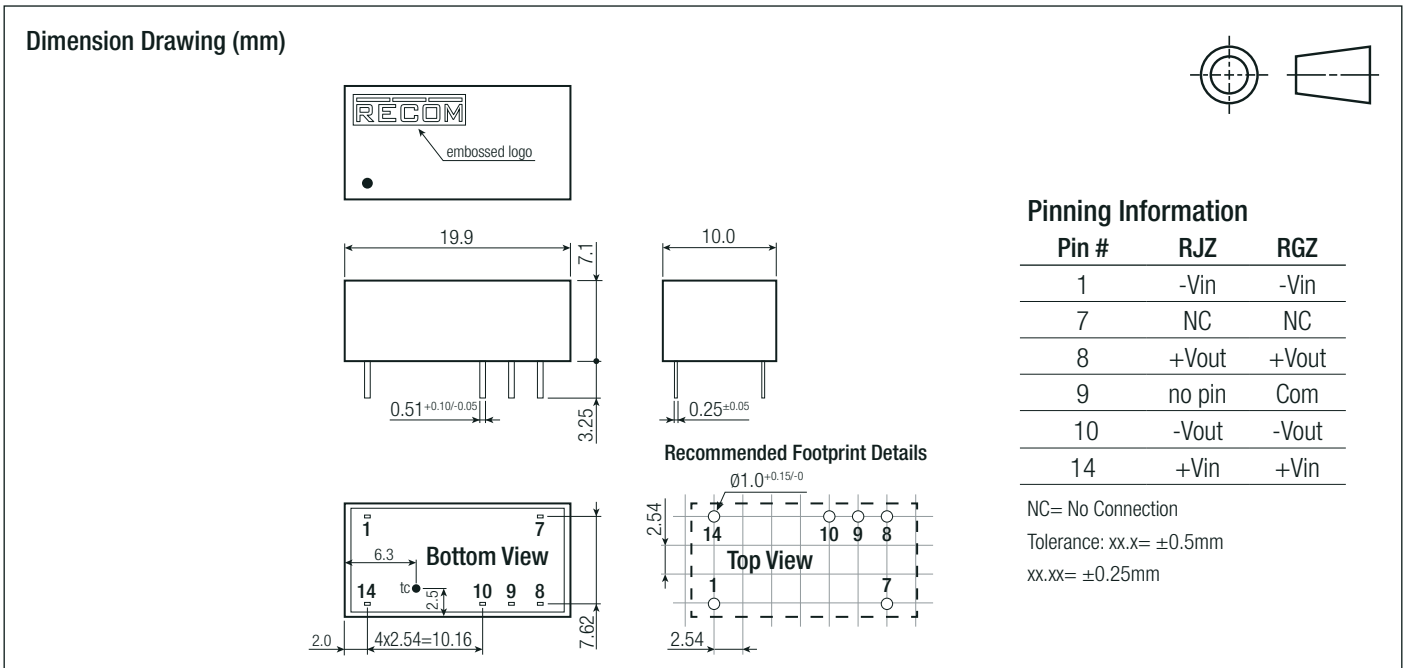

INSTALLATION AND APPLICATION

IGBT Application Circuit

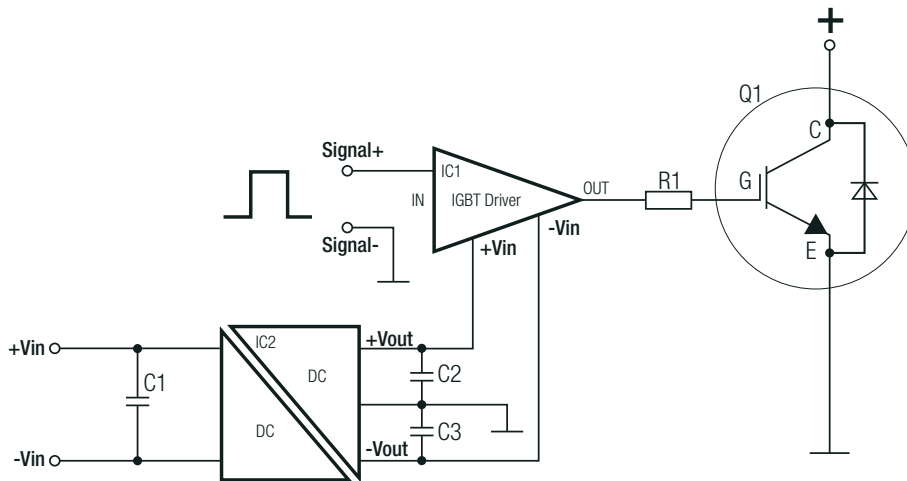

PACKAGING INFORMATION

| Parameter | Type | Value |
|-----------------------------|----------------|-----------------------|
| Packaging Dimension (LxWxH) | tube | 520.0 x 17.0 x 10.0mm |
| Packaging Quantity | tube | 24pcs |
| Storage Temperature Range | | -55°C to +125°C |
| Storage Humidity | non-condensing | 95% RH max. |

The product information and specifications may be subject to changes even without prior written notice. The product has been designed for various applications; its suitability lies in the responsibility of each customer. The products are not authorized for use in safety-critical applications without RECOM's explicit written consent. A safety-critical application is an application where a failure may reasonably be expected to endanger or cause loss of life, inflict bodily harm or damage property. The applicant shall indemnify and hold harmless RECOM, its affiliated companies and its representatives against any damage claims in connection with the unauthorized use of RECOM products in such safety-critical applications.