

CPINF5204-HF

RoHS Device
Halogen Free



Features

- High Power Handling for VHF/UHF band.
- Low Capacitance at Zero Bias, Extremely Small Reverse Bias.
- Low Series Resistance.
- Very Low Insertion Loss, High Isolation.

Mechanical data

- Case: 1005/SOD-323F standard package, molded plastic.
- Terminals: Gold plated, solderable per MIL-STD-750, method 2026.
- Polarity: Indicated by cathode band.
- Weight: 0.006 grams(approx.).

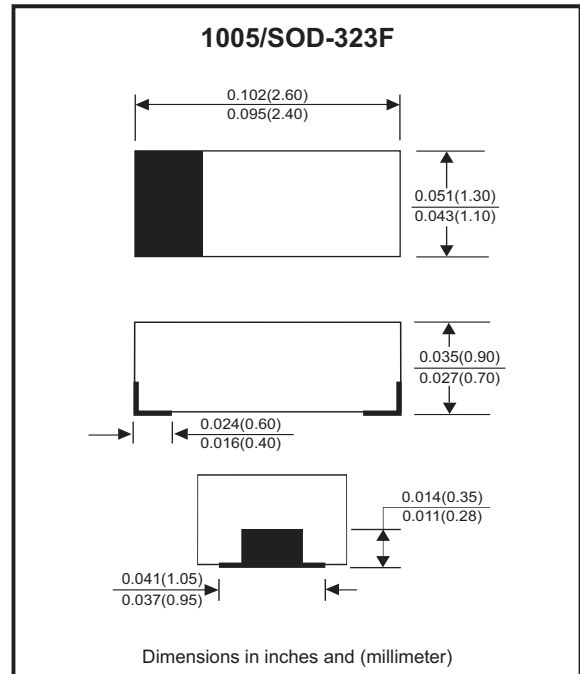

Circuit Diagram



Maximum Rating (at TA=25°C unless otherwise noted)

Parameter	Symbol	Rating	Unit
Reverse Voltage	V _R	180	V
Power Dissipation (Note 1)	P _D	500	mW
Junction Temperature	T _J	150	°C
Storage Temperature Range	T _{STG}	-55~+150	°C

Note: 1. Mounting on glass epoxy PCB (50mm x 50mm x 1.6mm).

Electrical Characteristics (at TA=25°C unless otherwise noted)

Parameter	Conditions	Symbol	Min	Typ	Max	Unit
Reverse Current	V _R = 180V	I _R	-	-	10	μA
Forward Voltage	I _F = 100mA	V _F	-	-	1.0	V
Diode Capacitance	V _R = 40V, f = 100MHz	C _T	-	-	0.9	pF
Forward Series Resistance	I _F = 50mA, f = 100MHz	R _{fs}	-	0.5	0.75	Ω

TYPICAL RATING AND CHARACTERISTIC CURVES (CPINF5204-HF)

Fig.1 - Forward Current VS. Forward Voltage

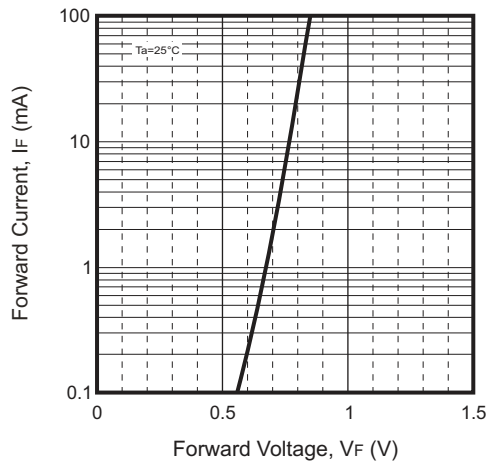

Fig.2 - Reverse Current VS. Reverse Voltage

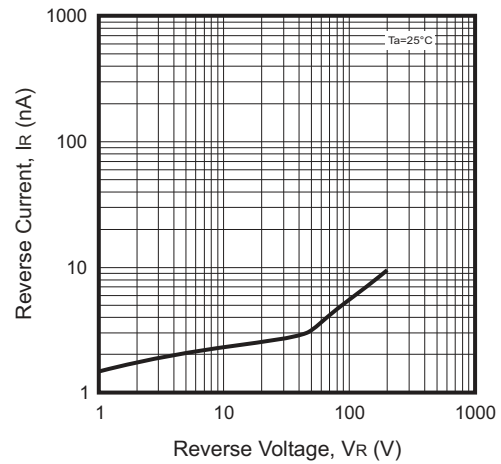

Fig.3 - Forward Series Resistance VS. Forward Current

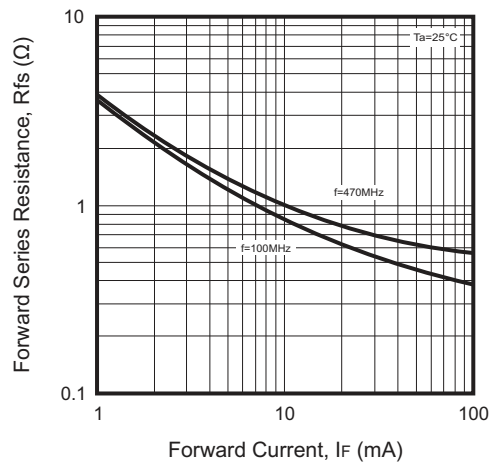
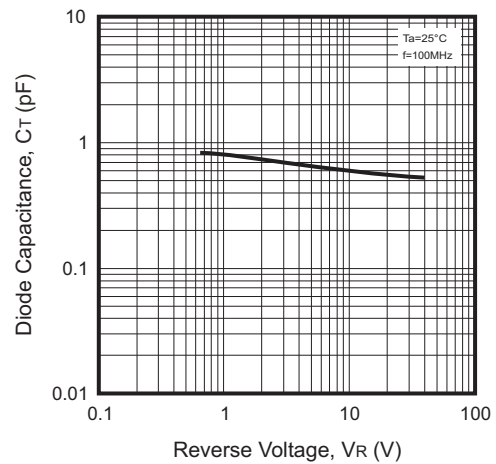
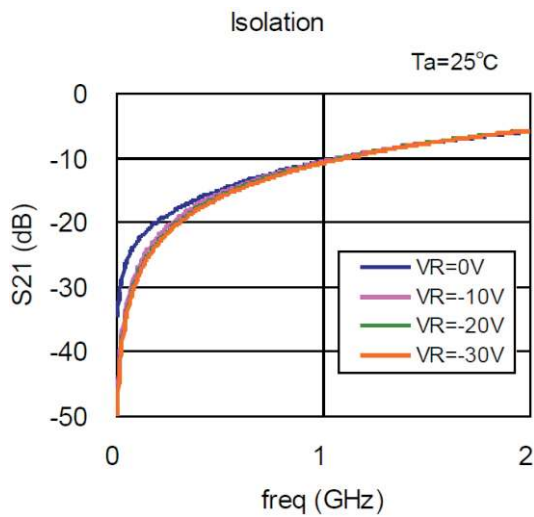
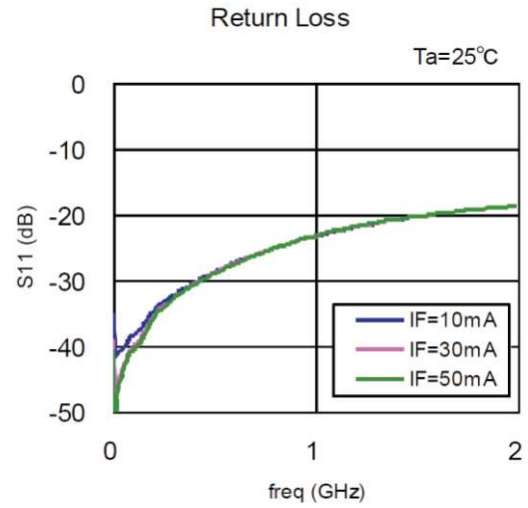
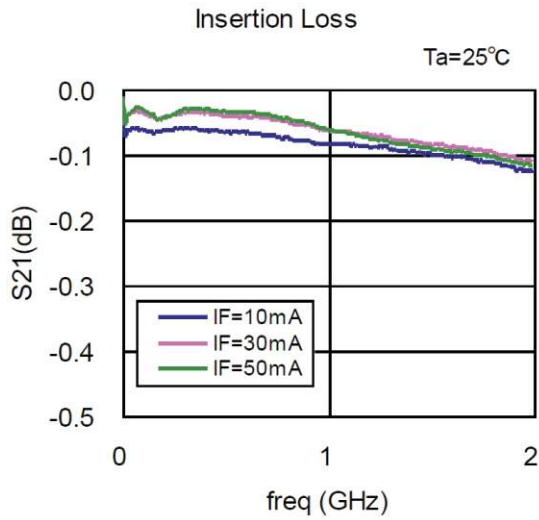

Fig.4 - Diode Capacitance VS. Reverse Voltage



TYPICAL RATING AND CHARACTERISTIC CURVES (CPINF5204-HF)



Note: Series configuration. Zo=50Ω
Losses of test fixtures are excluded from the measuring data.

Reel Taping Specification

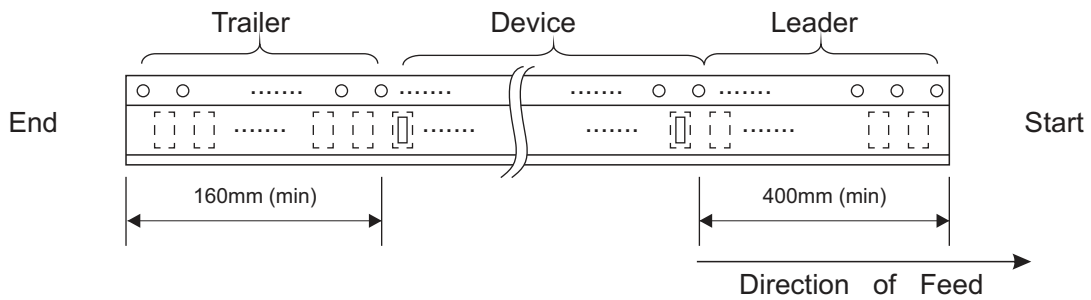
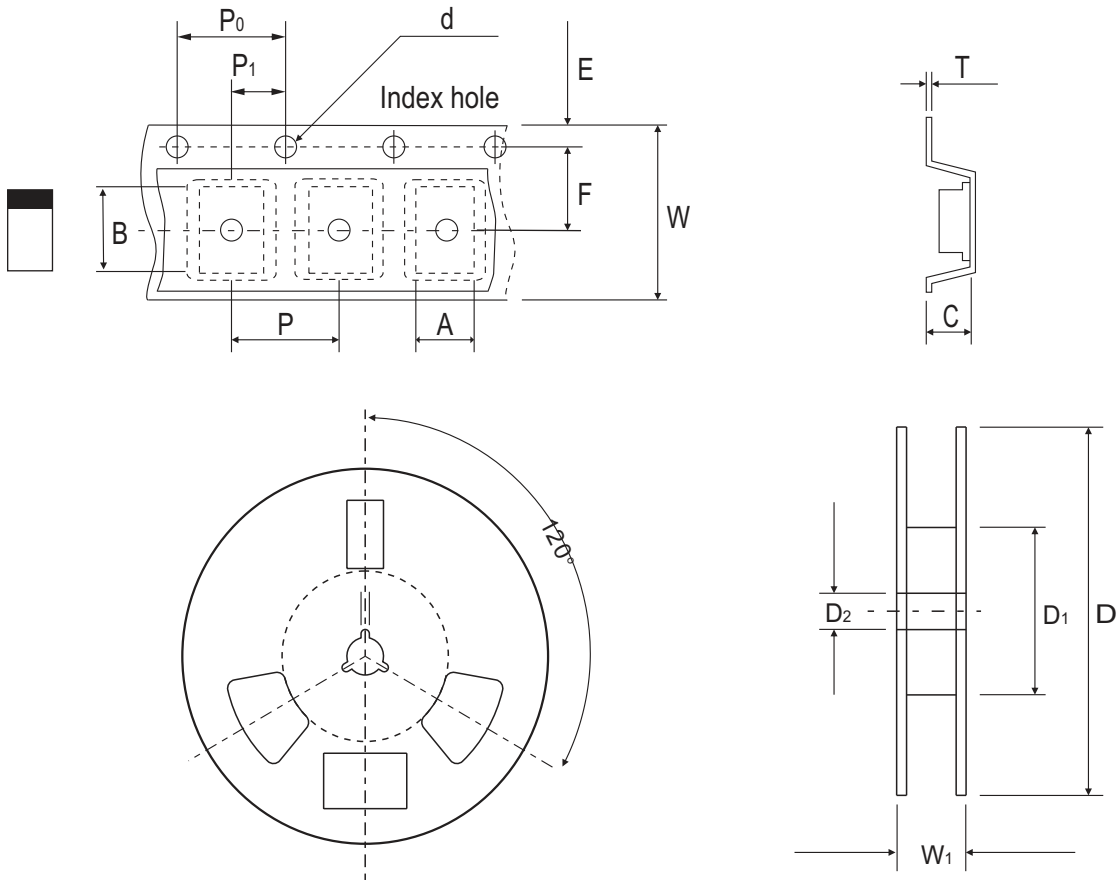

1005 (SOD-323F)	SYMBOL	A	B	C	d	D	D ₁	D ₂
	(mm)	1.45 ± 0.05	2.80 ± 0.05	1.00 ± 0.05	1.50 + 0.10 - 0	178.00 ± 1.00	60.00 ± 0.50	13.50 ± 0.20
	(inch)	0.057 ± 0.002	0.110 ± 0.002	0.039 ± 0.002	0.059 + 0.004 - 0	7.008 ± 0.039	2.362 ± 0.020	0.531 ± 0.008

1005 (SOD-323F)	SYMBOL	E	F	P	P ₀	P ₁	T	W	W ₁
	(mm)	1.75 ± 0.10	3.50 ± 0.05	4.00 ± 0.10	4.00 ± 0.10	2.00 ± 0.05	0.23 ± 0.05	8.00 ± 0.10	12.00 + 0.50 - 0
	(inch)	0.069 ± 0.004	0.138 ± 0.002	0.157 ± 0.004	0.157 ± 0.004	0.079 ± 0.002	0.009 ± 0.002	0.315 ± 0.004	0.472 + 0.020 - 0

Company reserves the right to improve product design , functions and reliability without notice.

Marking Code

Part Number	Marking Code
CPINF5204-HF	L1XXX

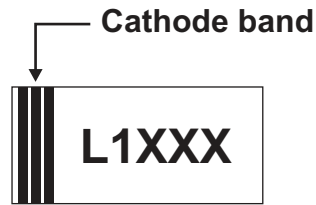

XXX = Lot code (3~4 digits)

Suggested PAD Layout

SIZE	1005/SOD-323F	
	(mm)	(inch)
A	2.10	0.083
B	1.20	0.047
C	1.20	0.047
D	3.30	0.130
E	0.90	0.035

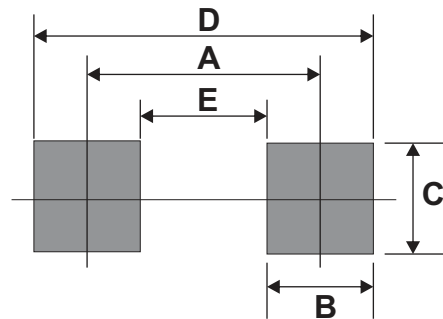

Standard Packaging

Case Type	REEL PACK	
	REEL (pcs)	Reel Size (inch)
1005/ SOD-323F	4,000	7