

VIEWS FROM "X"

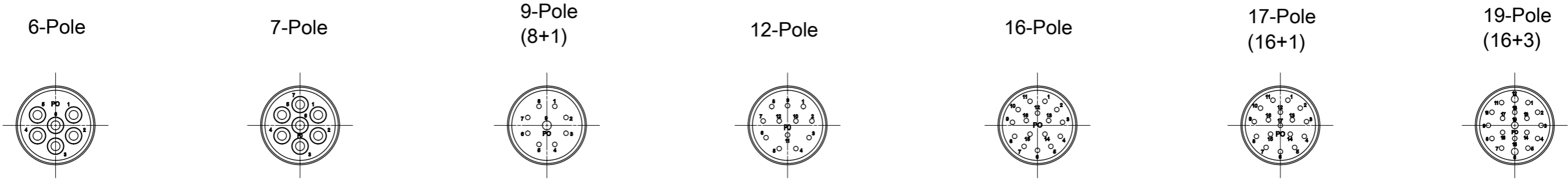

	CABLE DIAMETER	SOLDER CONTACTS		CRIMP CONTACTS		WITHOUT CONTACTS	
		ENGINEERING NO. / MOLEX P/N					
6 POLE	3-7mm	KAS6S06-551 / 1202300106		KAS6S06-401 / 1202300109		KAS6S06-001 / 1202300112	
	7-12mm	KAS6S06-555 / 1202300107		KAS6S06-405 / 1202300110		KAS6S06-005 / 1202300113	
	11-17mm	KAS6S06-559 / 1202300108		KAS6S06-409 / 1202300111		KAS6S06-009 / 1202300114	
CRIMP RANGE 0,75-2,5mm ²							
7 POLE	3-7mm	KAS7S06-551 / 1202300115		KAS7S06-401 / 1202300118		KAS7S06-001 / 1202300121	
	7-12mm	KAS7S06-555 / 1202300116		KAS7S06-405 / 1202300119		KAS7S06-005 / 1202300122	
	11-17mm	KAS7S06-559 / 1202300117		KAS7S06-409 / 1202300120		KAS7S06-009 / 1202300123	
CRIMP RANGE 0,75-2,5mm ²							
9 POLE (8+1)	3-7mm	KAS9S06-551 / 1202300124		KAS9S06-411 / 1202300127		KAS9S06-001 / 1202300130	
	7-12mm	KAS9S06-555 / 1202300125		KAS9S06-415 / 1202300128		KAS9S06-005 / 1202300131	
	11-17mm	KAS9S06-559 / 1202300126		KAS9S06-419 / 1202300129		KAS9S06-009 / 1202300132	
CRIMP RANGE 0,14-1,0mm ² / 0,75-2,5mm ²							
12 POLE	3-7mm	KASCS06-551 / 1202300133		KASCS06-011 / 1202300136		KASCS06-001 / 1202300139	
	7-12mm	KASCS06-555 / 1202300134		KASCS06-015 / 1202300137		KASCS06-005 / 1202300140	
	11-17mm	KASCS06-559 / 1202300135		KASCS06-019 / 1202300138		KASCS06-009 / 1202300141	
CRIMP RANGE 0,14-1,0mm ²							
16 POLE	3-7mm	KASHS06-551 / 1202300142		KASHS06-011 / 1202300145		KASHS06-001 / 1202300148	
	7-12mm	KASHS06-555 / 1202300143		KASHS06-015 / 1202300146		KASHS06-005 / 1202300149	
	11-17mm	KASHS06-559 / 1202300144		KASHS06-019 / 1202300147		KASHS06-009 / 1202300150	
CRIMP RANGE 0,14-1,0mm ²							
17 POLE	3-7mm	KASJS06-551 / 1202300151		KASJS06-011 / 1202300154		KASJS06-001 / 1202300157	
	7-12mm	KASJS06-555 / 1202300152		KASJS06-015 / 1202300155		KASJS06-005 / 1202300158	
	11-17mm	KASJS06-559 / 1202300153		KASJS06-019 / 1202300156		KASJS06-009 / 1202300159	
CRIMP RANGE 0,14-1,0mm ²							
19 POLE	3-7mm	KASLS06-551 / 1202300160		KASLS06-111 / 1202300163		KASLS06-001 / 1202300166	
	7-12mm	KASLS06-555 / 1202300161		KASLS06-115 / 1202300164		KASLS06-005 / 1202300167	
	11-17mm	KASLS06-559 / 1202300162		KASLS06-119 / 1202300165		KASLS06-009 / 1202300168	
CRIMP RANGE 0,14-1,0mm ²							

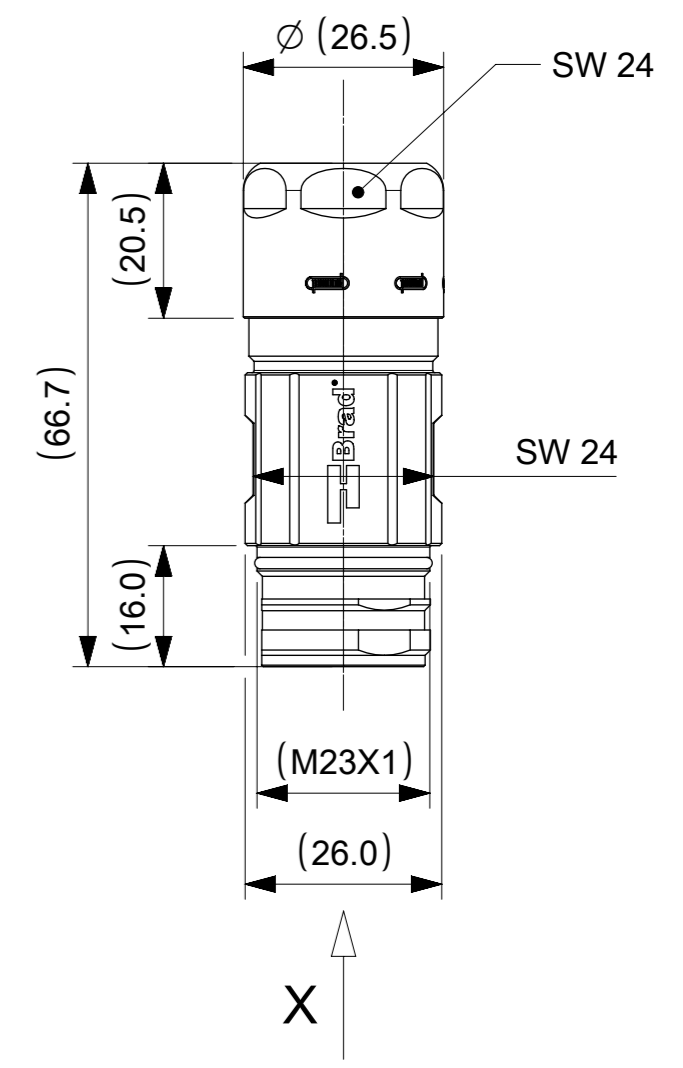

ELECTRICAL DATA FOR M23 SIGNAL INSERTS		
	VOLTAGE RATING	AMPERAGE RATING
6 POLE / 7 POLE	300 V	20A
9 POLE / 12 POLE	200 V	8A
16 POLE / 17 POLE	160 V	8A
19 POLE	100 V	8A

NOTES:
TOLERANCES (UNLESS SPECIFIED):
DIN ISO 2768 m

RELEASE STATUS	P1	RELEASE DATE	2022/01/28	14:25:36
----------------	----	--------------	------------	----------

QUALITY SYMBOLS ▽ = 0 ▽ = 0 ▽ = 0 ▽ = 0 ▽ = 0 ▽ = 0 ▽ = 0 ▽ = 0 ▽ = 0	THIS DRAWING CONTAINS INFORMATION THAT IS PROPRIETARY TO MOLEX ELECTRONIC TECHNOLOGIES, LLC AND SHOULD NOT BE USED WITHOUT WRITTEN PERMISSION		DIMENSION UNITS: mm SCALE: 1:1			
	EC NO: 693812 DRWN: ARPITT CHK'D: RSILLER APPR: RSILLER	2022/01/28 2022/01/28 2022/01/28	GENERAL TOLERANCES (UNLESS SPECIFIED) ANGULAR TOL ± °			DRWN BY: RSILLER DATE: 2022/01/25
	DRAFT WHERE APPLICABLE MUST REMAIN WITHIN DIMENSIONS		4 PLACES ± 3 PLACES ± 2 PLACES ± 1 PLACE ± 0 PLACES ±			CHK'D BY: RSILLER DATE: 2022/01/28
	A1		DRIVING SIZE: A3 THIRD ANGLE PROJECTION			APPR BY: RSILLER DATE: 2022/01/28
PRODUCT CUSTOMER DRAWING			SERIES: 120230 MATERIAL NUMBER: SEE TABLE CUSTOMER: GENERAL MARKET			
DOCUMENT NUMBER: 1202300106			DOC TYPE: PSD DOC PART: 000 SHEET NUMBER: 1 OF 1			