

OBsolete - PART DISCONTINUED

Features

- $BV_{CEO} > 460V$
- $BV_{CES} > 700V$
- $BV_{EBO} > 9V$
- $I_C = 1.5A$ High Continuous Collector Current
- **Totally Lead-Free & Fully RoHS Compliant (Notes 1 & 2)**
- **Halogen and Antimony Free. "Green" Device (Note 3)**
- **For automotive applications requiring specific change control (i.e. parts qualified to AEC-Q100/101/104/200, PPAP capable, and manufactured in IATF 16949 certified facilities), please [contact us](#) or your local Diodes representative. <https://www.diodes.com/quality/product-definitions/>**

Mechanical Data

- Package: TO252
- Package Material: Molded Plastic, "Green" Molding Compound. UL Flammability Classification Rating 94V-0
- Moisture Sensitivity: Level 1 per J-STD-020
- Terminals: Finish – Matte Tin Plated Leads; Solderable per MIL-STD-202, Method 208 (B3)
- Weight: 0.34 grams (Approximate)

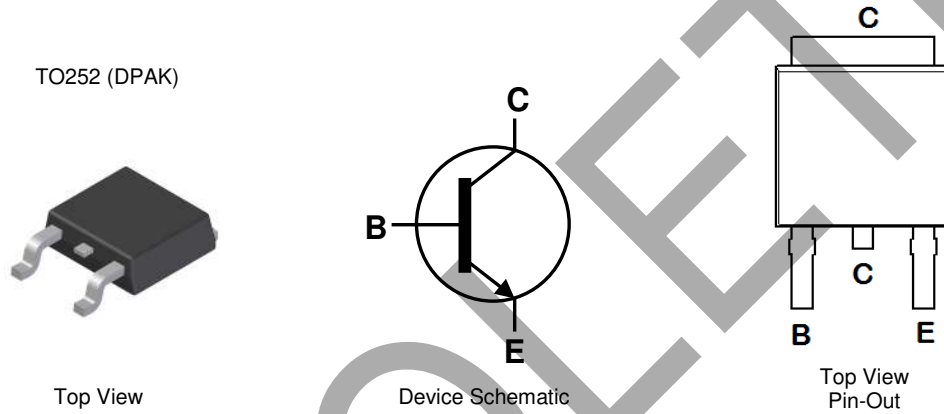

Ordering Information (Note 4)

Part Number	Package	Marking	Reel Size (inches)	Tape Width (mm)	Packing	
					Qty.	Carrier
DXT13003EK-13	TO252 (DPAK)	13003E	13	16	2,500	Reel

- Notes:
1. No purposely added lead. Fully EU Directive 2002/95/EC (RoHS), 2011/65/EU (RoHS 2) & 2015/863/EU (RoHS 3) compliant.
 2. See <https://www.diodes.com/quality/lead-free/> for more information about Diodes Incorporated's definitions of Halogen- and Antimony-free, "Green" and Lead-free.
 3. Halogen- and Antimony-free "Green" products are defined as those which contain <900ppm bromine, <900ppm chlorine (<1500ppm total Br + Cl) and <1000ppm antimony compounds.
 4. For packaging details, go to our website at <https://www.diodes.com/design/support/packaging/diodes-packaging/>.

Marking Information

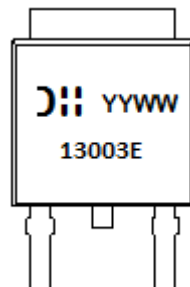

- 13003E = Product Type Marking Code
- Dii** = Manufacturer's Code Marking
- YYWW = Date Code Marking
- YY = Last Two Digits of Year (ex: 23 = 2023)
- WW = Week Code (01 to 53)

Absolute Maximum Ratings (@T_A = +25°C, unless otherwise specified.)

Characteristic	Symbol	Value	Unit
Collector-Emitter Voltage (V _{BE} = 0V)	V _{CES}	700	V
Collector-Emitter Voltage	V _{CEO}	460	V
Emitter-Base Voltage	V _{EBO}	9	V
Continuous Collector Current	I _C	1.5	A
Peak Pulse Collector Current (Note 5)	I _{CM}	3	A
Continuous Base Current	I _B	0.75	A
Peak Pulse Base Current (Note 5)	I _{BM}	1.5	A

Thermal Characteristics (@T_A = +25°C, unless otherwise specified.)

Characteristic	Symbol	Value	Unit
Power Dissipation	P _D	(Note 6)	3.9
		(Note 7)	2.5
		(Note 8)	2.1
		(Note 9)	1.6
Thermal Resistance, Junction to Ambient Air	R _{θJA}	(Note 6)	32
		(Note 7)	51
		(Note 8)	59
		(Note 9)	80
Thermal Resistance, Junction to Leads	R _{θJL}	3	°C/W
Operating and Storage Temperature Range	T _J , T _{STG}	-55 to +150	°C

ESD Ratings (Note 11)

Characteristic	Symbol	Value	Unit	JEDEC Class
Electrostatic Discharge - Human Body Model	ESD HBM	8,000	V	3B
Electrostatic Discharge - Machine Model	ESD MM	400	V	C

- Notes:
- Pulse test for pulse width < 5ms, duty cycle ≤ 10%.
 - For a device mounted with the exposed collector pad on 50mm x 50mm 2oz copper that is on a single-sided 1.6mm FR-4 PCB; device is measured under still air conditions whilst operating in a steady-state.
 - Same as Note 6, except the device is surface mounted on 25mm x 25mm 2oz copper.
 - Same as Note 6, except the device is surface mounted on 25mm x 25mm 1oz copper.
 - Same as Note 6, except mounted on minimum recommended pad (MRP) layout.
 - Thermal resistance from junction to solder-point (on the exposed collector pad).
 - Refer to JEDEC specification JESD22-A114 and JESD22-A115.

Thermal Characteristics and Derating Information

OBSOLETE - PART DISCONTINUED

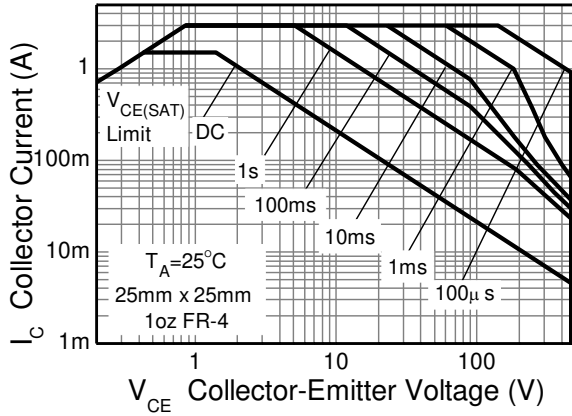

Figure 1. Safe Operating Area

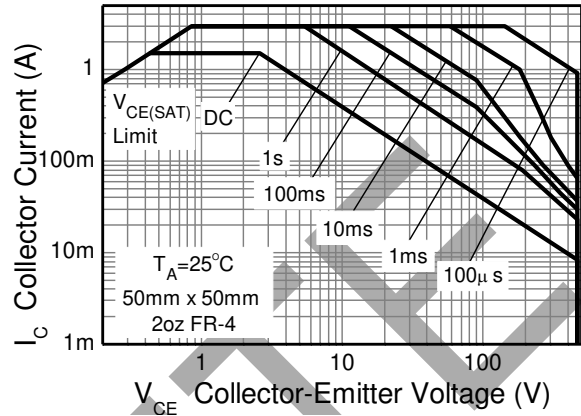

Figure 2. Safe Operating Area

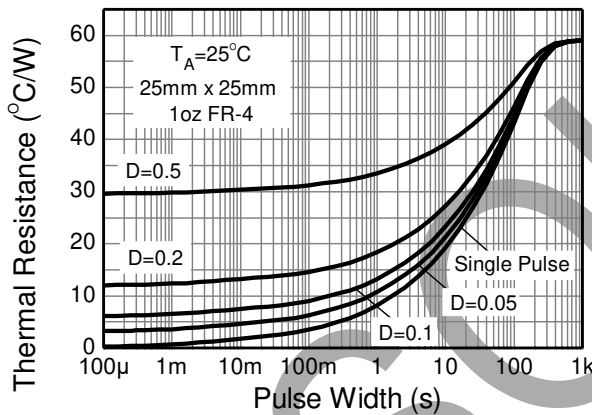

Figure 3. Transient Thermal Impedance

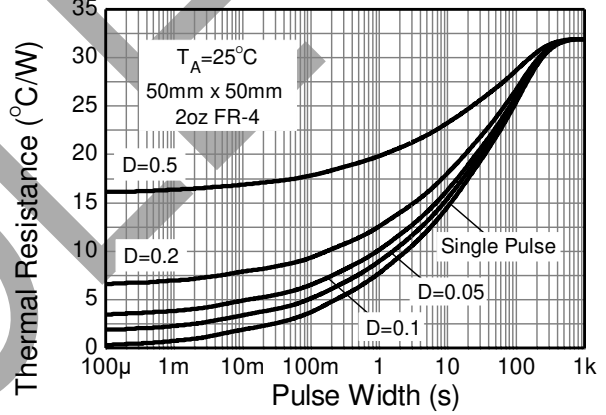

Figure 4. Transient Thermal Impedance

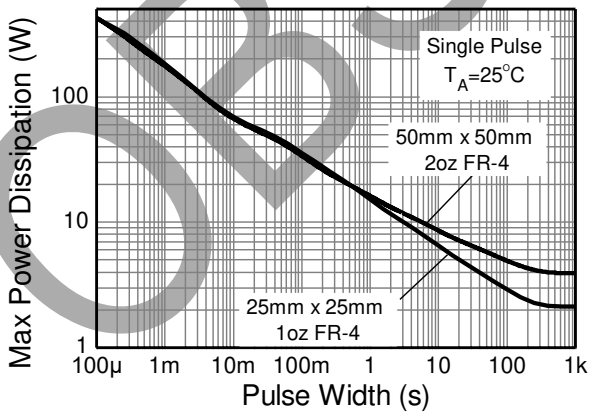

Figure 5. Pulse Power Dissipation

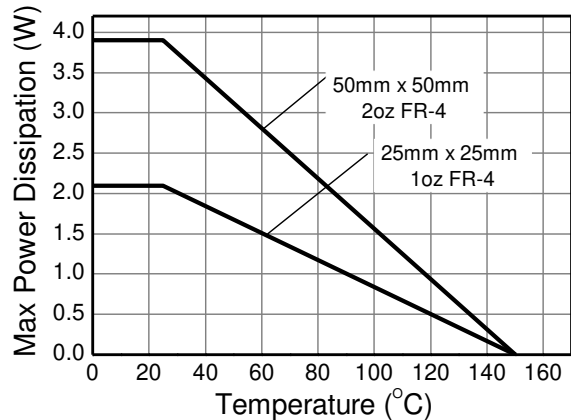

Figure 6. Derating Curve

Electrical Characteristics (@T_A = +25°C, unless otherwise specified.)

Characteristic	Symbol	Min	Typ	Max	Unit	Test Condition
Collector-Emitter Breakdown Voltage	BV _{CES}	700	—	—	V	I _C = 100μA, V _{BE} = 0V
Collector-Emitter Breakdown Voltage	BV _{CEO}	460	—	—	V	I _C = 100μA
Emitter-Base Breakdown Voltage	BV _{EBO}	9	—	—	V	I _E = 100μA
Collector Cutoff Current	I _{CEV}	—	—	10	μA	V _{CE} = 700V, V _{BE} = -1.5V
DC Current Transfer Static Ratio (Note 12)	h _{FE}	15	—	—	—	I _C = 0.3A, V _{CE} = 2V
		14	17	30	—	I _C = 0.5A, V _{CE} = 2V
		5	—	25	—	I _C = 1.0A, V _{CE} = 2V
Collector-Emitter Saturation Voltage (Note 12)	V _{CE(sat)}	—	0.17	0.3	V	I _C = 0.5A, I _B = 0.1A
		—	0.29	0.4		I _C = 1A, I _B = 0.25A
Base-Emitter Saturation Voltage (Note 12)	V _{BE(sat)}	—	—	1.0	V	I _C = 0.5A, I _B = 0.1A
		—	—	1.2		I _C = 1A, I _B = 0.25A
Output Capacitance	C _{ob}	—	16	—	pF	V _{CB} = 10V, f = 0.1MHz
Transition Frequency	f _T	4	—	—	MHz	I _C = 0.1A, V _{CE} = 10V
Turn-on Time with Resistive Load	t _{ON}	—	0.43	—	μs	I _C = 1A, V _{CC} = 125V, I _{B1} = 0.2A I _{B2} = -0.2A
Storage Time with Resistive Load	t _S	—	1.64	—		
Fall Time with Resistive Load	t _F	—	0.28	—		

Note: 12. Measured under pulsed conditions. Pulse width ≤ 300μs. Duty cycle ≤ 2%.

OBSOLETE - PART DISCONTINUED

OBSOLETE

Typical Electrical Characteristics (@ $T_A = +25^\circ\text{C}$, unless otherwise specified.)

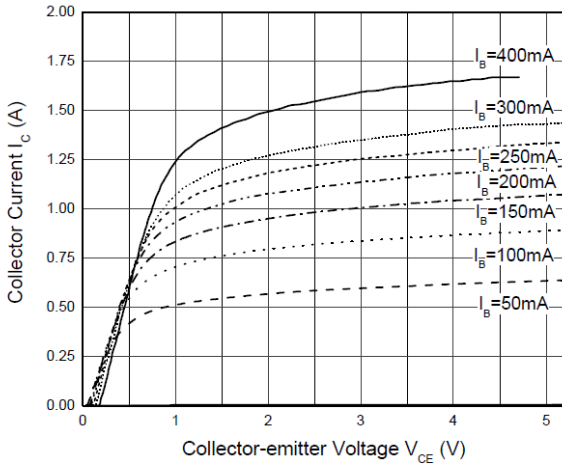

Figure 7. Static Characteristics

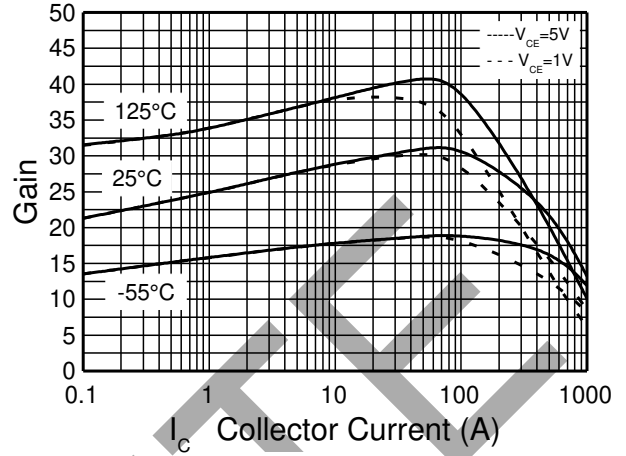

Figure 8. h_{FE} v I_C

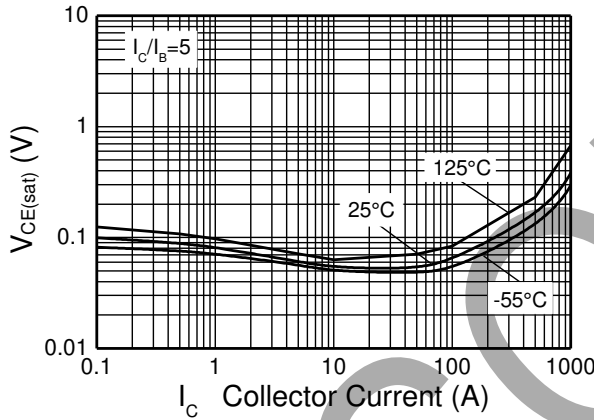

Figure 9. $V_{CE(sat)}$ v I_C

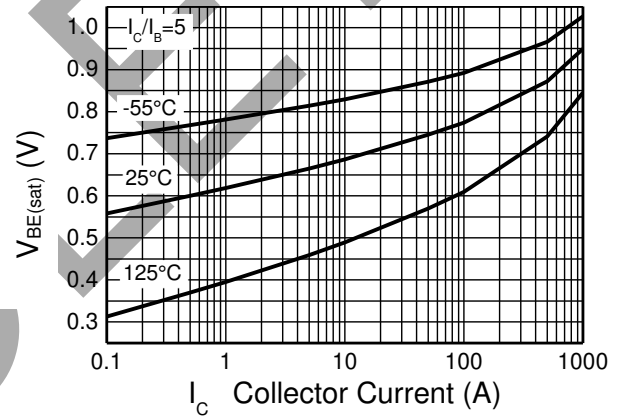

Figure 10. $V_{BE(sat)}$ v I_C

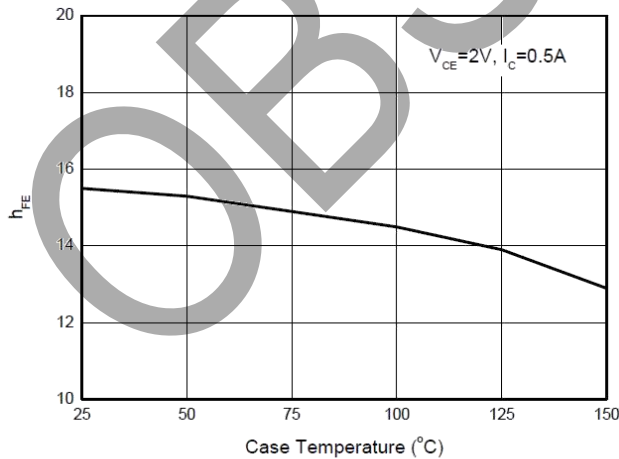

Figure 11. h_{FE} vs. Case Temperature

OBSOLETE - PART DISCONTINUED

Package Outline Dimensions

Please see <http://www.diodes.com/package-outlines.html> for the latest version.

TO252 (DPAK)

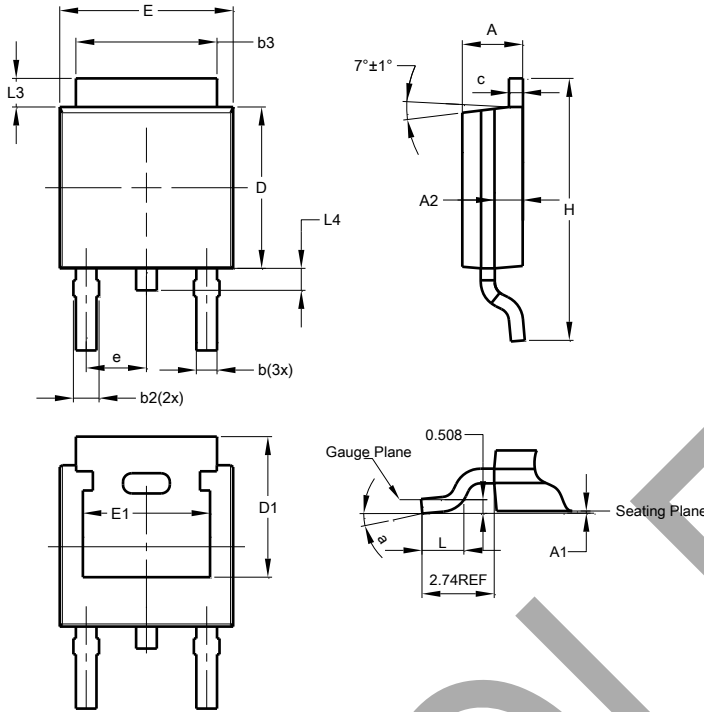

TO252 (DPAK)			
Dim	Min	Max	Typ
A	2.19	2.39	2.29
A1	0.00	0.13	0.08
A2	0.97	1.17	1.07
b	0.64	0.88	0.783
b2	0.76	1.14	0.95
b3	5.21	5.46	5.33
c	0.45	0.58	0.531
D	6.00	6.20	6.10
D1	5.21	—	—
e	—	—	2.286
E	6.45	6.70	6.58
E1	4.32	—	—
H	9.40	10.41	9.91
L	1.40	1.78	1.59
L3	0.88	1.27	1.08
L4	0.64	1.02	0.83
a	0°	10°	—
All Dimensions in mm			

Suggested Pad Layout

Please see <http://www.diodes.com/package-outlines.html> for the latest version.

TO252 (DPAK)

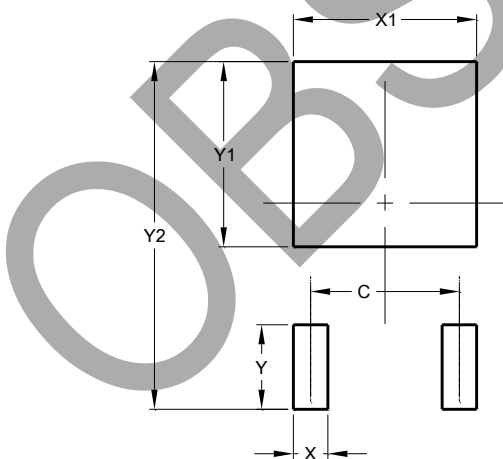

Dimensions	Value (in mm)
C	4.572
X	1.060
X1	5.632
Y	2.600
Y1	5.700
Y2	10.700

Note: 13. For high voltage applications, the appropriate industry sector guidelines should be considered with regards to creepage and clearance distances between device terminals and PCB tracking.

OBSOLETE - PART DISCONTINUED

IMPORTANT NOTICE

1. DIODES INCORPORATED (Diodes) AND ITS SUBSIDIARIES MAKE NO WARRANTY OF ANY KIND, EXPRESS OR IMPLIED, WITH REGARDS TO ANY INFORMATION CONTAINED IN THIS DOCUMENT, INCLUDING, BUT NOT LIMITED TO, THE IMPLIED WARRANTIES OF MERCHANTABILITY, FITNESS FOR A PARTICULAR PURPOSE OR NON-INFRINGEMENT OF THIRD PARTY INTELLECTUAL PROPERTY RIGHTS (AND THEIR EQUIVALENTS UNDER THE LAWS OF ANY JURISDICTION).
2. The Information contained herein is for informational purpose only and is provided only to illustrate the operation of Diodes' products described herein and application examples. Diodes does not assume any liability arising out of the application or use of this document or any product described herein. This document is intended for skilled and technically trained engineering customers and users who design with Diodes' products. Diodes' products may be used to facilitate safety-related applications; however, in all instances customers and users are responsible for (a) selecting the appropriate Diodes products for their applications, (b) evaluating the suitability of Diodes' products for their intended applications, (c) ensuring their applications, which incorporate Diodes' products, comply the applicable legal and regulatory requirements as well as safety and functional-safety related standards, and (d) ensuring they design with appropriate safeguards (including testing, validation, quality control techniques, redundancy, malfunction prevention, and appropriate treatment for aging degradation) to minimize the risks associated with their applications.
3. Diodes assumes no liability for any application-related information, support, assistance or feedback that may be provided by Diodes from time to time. Any customer or user of this document or products described herein will assume all risks and liabilities associated with such use, and will hold Diodes and all companies whose products are represented herein or on Diodes' websites, harmless against all damages and liabilities.
4. Products described herein may be covered by one or more United States, international or foreign patents and pending patent applications. Product names and markings noted herein may also be covered by one or more United States, international or foreign trademarks and trademark applications. Diodes does not convey any license under any of its intellectual property rights or the rights of any third parties (including third parties whose products and services may be described in this document or on Diodes' website) under this document.
5. Diodes' products are provided subject to Diodes' Standard Terms and Conditions of Sale (<https://www.diodes.com/about/company/terms-and-conditions/terms-and-conditions-of-sales/>) or other applicable terms. This document does not alter or expand the applicable warranties provided by Diodes. Diodes does not warrant or accept any liability whatsoever in respect of any products purchased through unauthorized sales channel.
6. Diodes' products and technology may not be used for or incorporated into any products or systems whose manufacture, use or sale is prohibited under any applicable laws and regulations. Should customers or users use Diodes' products in contravention of any applicable laws or regulations, or for any unintended or unauthorized application, customers and users will (a) be solely responsible for any damages, losses or penalties arising in connection therewith or as a result thereof, and (b) indemnify and hold Diodes and its representatives and agents harmless against any and all claims, damages, expenses, and attorney fees arising out of, directly or indirectly, any claim relating to any noncompliance with the applicable laws and regulations, as well as any unintended or unauthorized application.
7. While efforts have been made to ensure the information contained in this document is accurate, complete and current, it may contain technical inaccuracies, omissions and typographical errors. Diodes does not warrant that information contained in this document is error-free and Diodes is under no obligation to update or otherwise correct this information. Notwithstanding the foregoing, Diodes reserves the right to make modifications, enhancements, improvements, corrections or other changes without further notice to this document and any product described herein. This document is written in English but may be translated into multiple languages for reference. Only the English version of this document is the final and determinative format released by Diodes.
8. Any unauthorized copying, modification, distribution, transmission, display or other use of this document (or any portion hereof) is prohibited. Diodes assumes no responsibility for any losses incurred by the customers or users or any third parties arising from any such unauthorized use.
9. This Notice may be periodically updated with the most recent version available at <https://www.diodes.com/about/company/terms-and-conditions/important-notice>

The Diodes logo is a registered trademark of Diodes Incorporated in the United States and other countries.
All other trademarks are the property of their respective owners.
© 2023 Diodes Incorporated. All Rights Reserved.

www.diodes.com