



Parameter	Rating	Units
AC Operating Voltage	260	V_{rms}
Load Current	1	A_{rms}
On State Voltage Drop	1.6	V_{rms} (at $I_L = 1A_{rms}$)

Features

- Load Current up to $1A_{rms}$
- $600V_p$ Blocking Voltage
- 5mA Sensitivity
- Zero-Crossing Detection
- DC Control, AC Output
- Optically Isolated
- Low EMI and RFI Generation
- High Noise Immunity
- Flammability Rating UL 94 V-0

Applications

- Programmable Control
- Process Control
- Power Control Panels
- Remote Switching
- Gas Pump Electronics
- Contactors
- Large Relays
- Solenoids
- Motors
- Heaters

Description

The CPC1965G is an AC Solid State Switch using patented waveguide coupling with dual power SCR outputs to produce an alternative to optocoupler and Triac circuits. The switches are robust enough to provide a blocking voltage of up to $600V_p$.

In addition, tightly controlled zero-cross circuitry ensures switching of AC loads without the generation of transients.

The input and output circuits are optically coupled to provide $3750V_{rms}$ of isolation and noise immunity between control and load circuits. As a result, the CPC1965G is well suited for industrial environments where electromagnetic interference could disrupt the operation of electromechanical relays.

Approvals

- UL Recognized Component: File E69938
- CSA Certified Component: File 043639

Ordering Information

Part #	Description
CPC1965G	4-Pin (16-Pin Body) DIP (25/Tube)

Pin Configuration

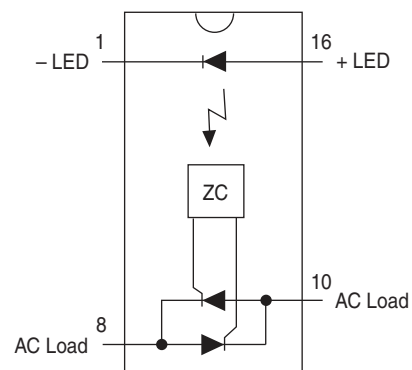

Absolute Maximum Ratings @ 25°C

Parameter	Ratings	Units
Blocking Voltage	600	V _P
Reverse Input Voltage	5	V
Input Control Current Peak (10ms)	100	mA
	1	A
Input Power Dissipation ¹	150	mW
PD, Total Package Dissipation ²	1600	mW
Isolation Voltage, Input to Output	3750	V _{rms}
Operational Temperature	-40 to +85	°C
Storage Temperature	-40 to +125	°C

¹ Derate linearly 1.33 mW / °C

² Derate linearly 16.6 mW / °C

Absolute Maximum Ratings are stress ratings. Stresses in excess of these ratings can cause permanent damage to the device. Functional operation of the device at conditions beyond those indicated in the operational sections of this data sheet is not implied.

Typical values are characteristic of the device at +25°C, and are the result of engineering evaluations. They are provided for information purposes only, and are not part of the manufacturing testing requirements.

Electrical Characteristics @ 25°C

Parameters	Conditions	Symbol	Min	Typ	Max	Units			
Output Characteristics									
Operating Voltage Range	V _L	-	20	-	260	V _{rms}			
Load Current, Continuous	V _L =120-260V _{rms}	I _L	0.005	-	1	A _{rms}			
Non-Repetitive Single Cycle Surge Current	-	I _{TSM}	-	-	10	A			
Off State Leakage Current	V _L =600V _P	I _{LEAK}	-	-	1	mA			
On-State Voltage Drop	I _L =1A _{rms}	-	-	-	1.6	V _{rms}			
Critical Rate of Rise ³	-	dV/dt	1000	-	-	V/μs			
Switching Speeds	I _F =5 mA	-	-	-	-	cycles			
Turn-on							t _{on}	-	0.5
Turn-off							t _{off}	-	0.5
Zero-Cross Turn-On Voltage ¹	1st half-cycle	-	-	2	10	V			
	Subsequent half-cycle	-	-	1	-	V			
Operating Frequency	-	-	20	-	400	Hz			
Load Power Factor for Guaranteed Turn-On ²	-	PF	0.25	-	-	-			
Input Characteristics									
Input Control Current to Activate ⁴	-	I _F	-	0.8	5	mA			
Input Voltage Drop	I _F =5mA	V _F	0.9	1.2	1.5	V			
Input Drop-out Voltage	-	-	0.8	-	-	V			
Reverse Input Current	V _R =5V	I _R	-	-	10	μA			
Common Characteristics									
Input to Output Capacitance	V _{IO} =0V, f=1MHz	C _{IO}	-	3	-	pF			

¹ Zero Cross 1st half-cycle @ <100Hz

² Snubber circuits may be required at low power factors.

³ Tested in accordance with EIA/NARM standard RS-443.

⁴ For high noise environments, use I_F≥10mA.

PERFORMANCE DATA*

Typical LED Forward Voltage Drop
($I_F=5\text{mA}$, $T_A=25^\circ\text{C}$)

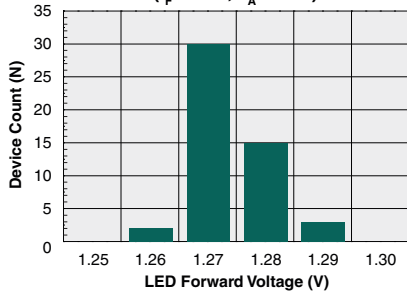

Typical On-State Voltage
($I_L=1\text{A}_{\text{rms}}$, $T_A=25^\circ\text{C}$)

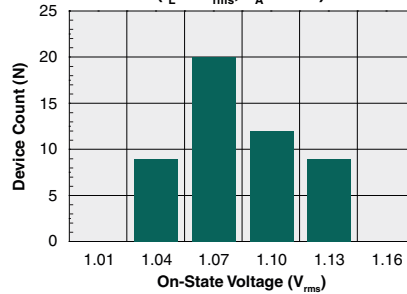

Typical Blocking Voltage Distribution
($T_A=25^\circ\text{C}$)

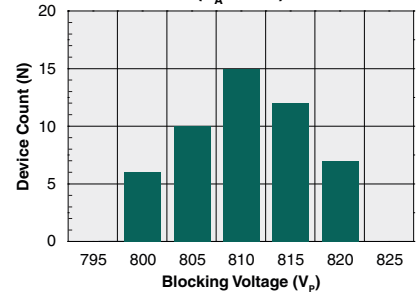

Typical I_F for Switch Operation
($I_L=1\text{A}_{\text{rms}}$, $T_A=25^\circ\text{C}$)

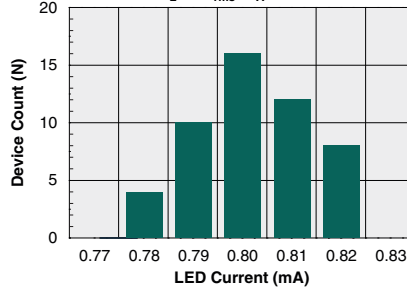

Typical LED Forward Voltage vs. Temperature

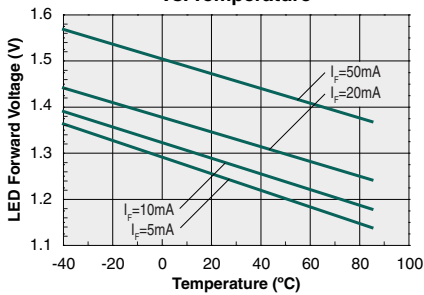

Typical I_F for Switch Operation vs. Temperature
($I_L=500\text{mA}_{\text{rms}}$)

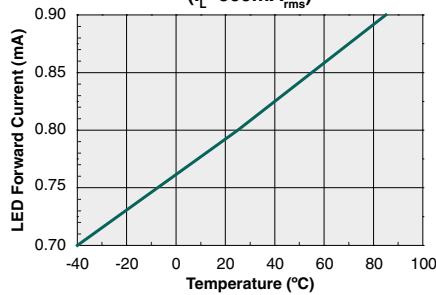

Typical On-State Voltage vs. Temperature
($I_L=500\text{mA}_{\text{rms}}$)

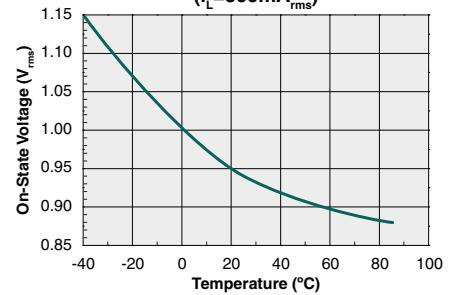

*Unless otherwise noted, data presented in these graphs is typical of device operation at 25°C. For guaranteed parameters not indicated in the written specifications, please contact our application department.

PERFORMANCE DATA*

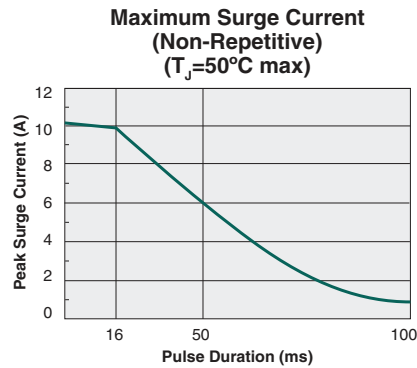
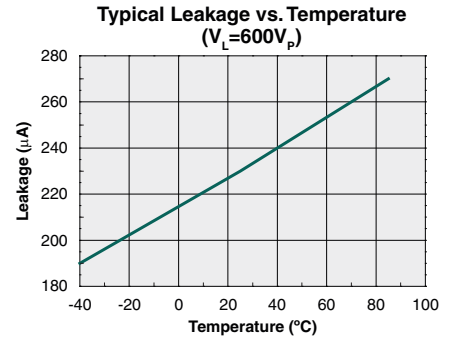
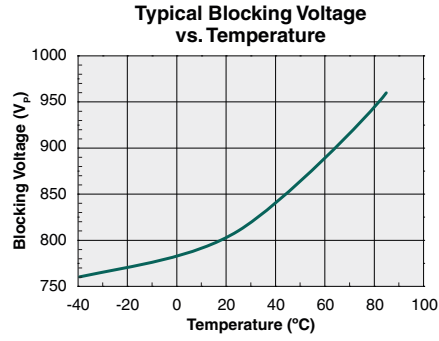
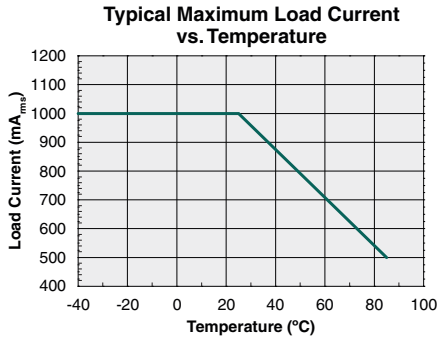

*Unless otherwise noted, data presented in these graphs is typical of device operation at 25°C.
For guaranteed parameters not indicated in the written specifications, please contact our application department.

Manufacturing Information

Moisture Sensitivity

 All plastic encapsulated semiconductor packages are susceptible to moisture ingress. IXYS Integrated Circuits classifies its plastic encapsulated devices for moisture sensitivity according to the latest version of the joint industry standard, **IPC/JEDEC J-STD-020**, in force at the time of product evaluation. We test all of our products to the maximum conditions set forth in the standard, and guarantee proper operation of our devices when handled according to the limitations and information in that standard as well as to any limitations set forth in the information or standards referenced below.

Failure to adhere to the warnings or limitations as established by the listed specifications could result in reduced product performance, reduction of operable life, and/or reduction of overall reliability.

This product carries a Moisture Sensitivity Level (MSL) classification as shown below, and should be handled according to the requirements of the latest version of the joint industry standard **IPC/JEDEC J-STD-033**.

Device	Moisture Sensitivity Level (MSL) Classification
CPC1965G	MSL 1

ESD Sensitivity

 This product is **ESD Sensitive**, and should be handled according to the industry standard **JESD-625**.

Soldering Profile

Provided in the table below is the Classification Temperature (T_C) of this product and the maximum dwell time the body temperature of this device may be ($T_C - 5$)°C or greater. The classification temperature sets the Maximum Body Temperature allowed for this device during lead-free reflow processes. For through-hole devices, and any other processes, the guidelines of **J-STD-020** must be observed.

Device	Classification Temperature (T_C)	Dwell Time (t_p)	Max Reflow Cycles
CPC1965G	245°C	30 seconds	1

Board Wash

IXYS Integrated Circuits recommends the use of no-clean flux formulations. Board washing to reduce or remove flux residue following the solder reflow process is acceptable provided proper precautions are taken to prevent damage to the device. These precautions include, but are not limited to: using a low pressure wash and providing a follow up bake cycle sufficient to remove any moisture trapped within the device due to the washing process. Due to the variability of the wash parameters used to clean the board, determination of the bake temperature and duration necessary to remove the moisture trapped within the package is the responsibility of the user (assembler). Cleaning or drying methods that employ ultrasonic energy may damage the device and should not be used. Additionally, the device must not be exposed to flux or solvents that are Chlorine- or Fluorine-based.



MECHANICAL DIMENSIONS

CPC1965G

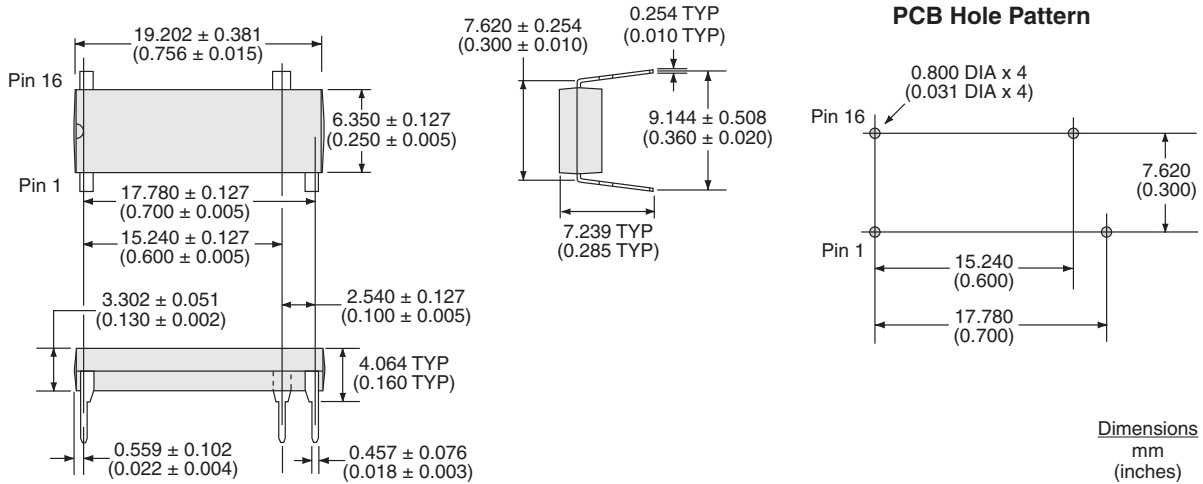

For additional information please visit our website at: www.ixysic.com

IXYS Integrated Circuits makes no representations or warranties with respect to the accuracy or completeness of the contents of this publication and reserves the right to make changes to specifications and product descriptions at any time without notice. Neither circuit patent licenses nor indemnity are expressed or implied. Except as set forth in IXYS Integrated Circuits' Standard Terms and Conditions of Sale, IXYS Integrated Circuits assumes no liability whatsoever, and disclaims any express or implied warranty, relating to its products including, but not limited to, the implied warranty of merchantability, fitness for a particular purpose, or infringement of any intellectual property right.

The products described in this document are not designed, intended, authorized or warranted for use as components in systems intended for surgical implant into the body, or in other applications intended to support or sustain life, or where malfunction of IXYS Integrated Circuits' product may result in direct physical harm, injury, or death to a person or severe property or environmental damage. IXYS Integrated Circuits reserves the right to discontinue or make changes to its products at any time without notice.

Specification: DS-CPC1965G-R08
 ©Copyright 2018, IXYS Integrated Circuits
 OptoMOS® is a registered trademark of IXYS Integrated Circuits
 All rights reserved. Printed in USA.
 6/20/2018