

LM710 Voltage Comparator

General Description

The LM710 series are high-speed voltage comparators intended for use as an accurate, low-level digital level sensor or as a replacement for operational amplifiers in comparator applications where speed is of prime importance. The circuit has a differential input and a single-ended output, with saturated output levels compatible with practically all types of integrated logic.

The device is built on a single silicon chip which insures low offset and thermal drift. The use of a minimum number of stages along with minority-carrier lifetime control (gold doping) makes the circuit much faster than operational amplifiers

in saturating comparator applications. In fact, the low stray and wiring capacitances that can be realized with monolithic construction make the device difficult to duplicate with discrete components operating at equivalent power levels.

The LM710 series are useful as pulse height discriminators, voltage comparators in high-speed A/D converters or go, no-go detectors in automatic test equipment. They also have applications in digital systems as an adjustable-threshold line receiver or an interface between logic types. In addition, the low cost of the units suggests them for applications replacing relatively simple discrete component circuitry.

Schematic and Connection Diagrams

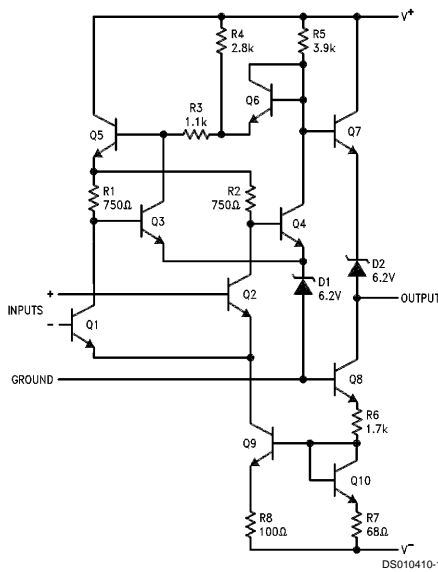

Ceramic Flatpak Package

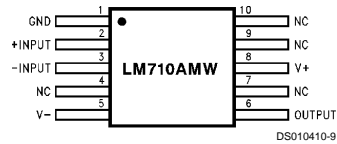

* Also available per JM38510/10301

Order Number LM710AMW/883*
See NS Package Number W10A

Schematic and Connection Diagrams (Continued)

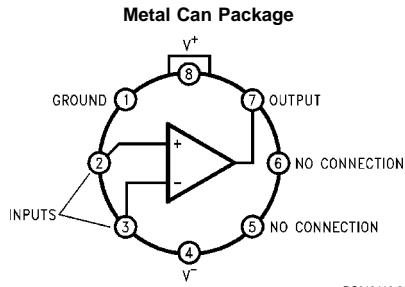

DS010410-2

Pin 4 is connected to case.

Top View
Order Number LM710AMH/883*, LM710H,
LM710H/883 or LM710CH
See NS Package Number H08C

* Also available per JM38510/10301

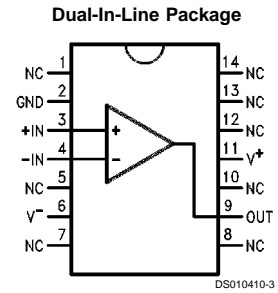

DS010410-3

Top View
Order Number
LM710AMJ/883* or LM710CN
See NS Package Number N14A or J14A

Absolute Maximum Ratings (Note *NO TARGET FOR FNxref NS0053*)

If Military/Aerospace specified devices are required, please contact the National Semiconductor Sales Office/ Distributors for availability and specifications.

Positive Supply Voltage	+14V
Negative Supply Voltage	-7V
Peak Output Current	10 mA
Output Short Circuit Duration	10 seconds
Differential Input Voltage	±5V
Input Voltage	±7V

Power Dissipation		
TO-99 (Note 1)		700 mW
Plastic Dual-In-Line Package (Note 2)		950 mW
Operating Temperature Range		
LM710		-55°C to +125°C
LM710C		0°C to +70°C
Storage Temperature Range		-65°C to +150°C
Lead Temperature (Soldering, 10 sec.)		260°C

Electrical Characteristics (Note 3)

Parameter	Conditions	LM710			LM710C			Units
		Min	Typ	Max	Min	Typ	Max	
Input Offset Voltage	$R_S \leq 200\Omega$, $V_{CM} = 0V$, $T_A = 25^\circ C$		0.6	2.0		1.6	5.0	mV
Input Offset Current	$V_{OUT} = 1.4V$, $T_A = 25^\circ C$		0.75	3.0		1.8	5.0	μA
Input Bias Current	$T_A = 25^\circ C$		13	20		16	25	μA
Voltage Gain	$T_A = 25^\circ C$	1250	1700		1000	1500		
Output Resistance	$T_A = 25^\circ C$		200			200		Ω
Output Sink Current	$V_{OUT} = 0$, $T_A = 25^\circ C$ $\Delta V_{IN} \geq 5 mV$ $\Delta V_{IN} \geq 10 mV$	2.0	2.5		1.6	2.5		mA mA
Response Time	$T_A = 25^\circ C$ (Note 4)		40			40		ns
Input Offset Voltage	$R_S \leq 200\Omega$, $V_{CM} = 0V$			3.0			6.5	mV
Average Temperature Coefficient of Input Offset Voltage	$T_{MIN} \leq T_A \leq T_{MAX}$ $R_S \leq 50\Omega$		3.0	10		5.0	20	$\mu V/^\circ C$
Input Offset Current	$T_A = T_{A MAX}$ $T_A = T_{A MIN}$		0.25	3.0			7.5	μA μA
Average Temperature Coefficient of Input Offset Current	$25^\circ C \leq T_A \leq T_{MAX}$ $T_{MIN} \leq T_A \leq 25^\circ C$		5.0	25		15	50	$nA/^\circ C$ $nA/^\circ C$
Input Bias Current	$T_A = T_{MIN}$		27	45		25	40	μA
Input Voltage Range	$V^- = -7V$	±5.0			±5.0			V
Common-Mode Rejection Ratio	$R_S \leq 200\Omega$	80	100		70	98		dB
Differential Input Voltage Range		±5.0			±5.0			V
Voltage Gain		1000			800			V/V
Positive Output Level	$-5 mA \leq I_{OUT} \leq 0$ $V_{IN} \geq 5 mV$ $V_{IN} \geq 10 mV$	2.5	3.2	4.0				V V
Negative Output Level	$V_{IN} \geq 5 mV$ $V_{IN} \geq 10 mV$	-1.0	-0.5	0	-1.0	-0.5	0	V V
Output Sink Current	$V_{IN} \geq 5 mV$, $V_{OUT} = 0$ $T_A = 125^\circ C$ $T_A = -55^\circ C$	0.5	1.7					mA mA
	$V_{IN} \geq 10 mV$, $V_{OUT} = 0$ $0^\circ C \leq T_A \leq +70^\circ C$				0.5			mA
Positive Supply Current	$V_{IN} \geq 5 mV$ $V_{IN} \geq 10 mV$		5.2	9.0				mA mA
Negative Supply Current	$V_{IN} \geq 5 mV$ $V_{IN} \geq 10 mV$		4.6	7.0		4.6	7.0	mA mA

Electrical Characteristics (Note 3) (Continued)

Parameter	Conditions	LM710			LM710C			Units
		Min	Typ	Max	Min	Typ	Max	
Power Consumption	$I_{OUT} = 0$		90	150				mW
	$V_{IN} \geq 5 \text{ mV}$							
	$V_{IN} \geq 10 \text{ mV}$						150	mW

Note 1: Rating applies for ambient temperatures of 25°C; derate linearly at 5.6 mW/°C for ambient temperatures above 25°C.

Note 2: Derate linearly at 9.5 mW/°C for ambient temperatures above 25°C.

Note 3: These specifications apply for $V^+ = 12\text{V}$, $V^- = -6\text{V}$, $-55^\circ\text{C} \leq T_A \leq +125^\circ\text{C}$ for LM710 and $0^\circ\text{C} \leq T_A \leq +70^\circ\text{C}$ for LM710C unless otherwise specified: The input offset voltage and input offset current (see definitions) are specified for a logic threshold voltage of 1.8V at -55°C , 1.4V at 25°C , and 1V at 125°C for LM710 and 1.5V at 0°C , 1.4V at 25°C , and 1.2V at 70°C for LM710C.

Note 4: The response time specified (see definitions) is for a 100 mV input step with 5 mV overdrive (LM710) or a 10 mV overdrive (LM710C).

Typical Applications

Schmitt Trigger

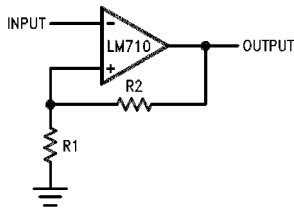

DS010410-4

Line Receive with Increased Output Sink Current

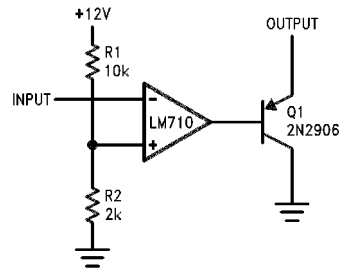

DS010410-5

Pulse Width Modulator

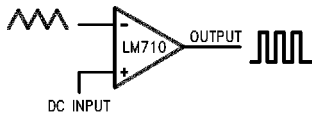

DS010410-6

Level Detector with Lamp Driver

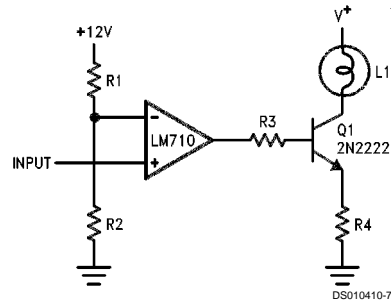

DS010410-7

Typical Performance Characteristics

Transfer Function

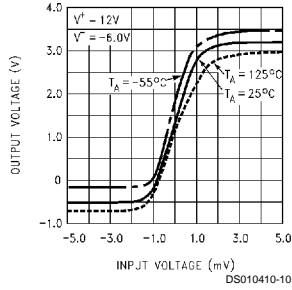

Voltage Gain

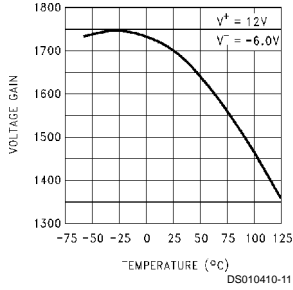

Voltage Gain

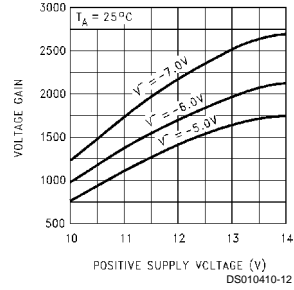

Input Bias Current

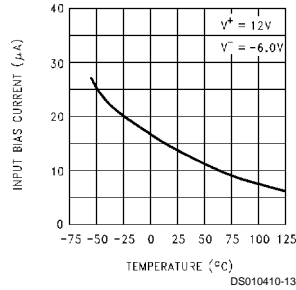

Input Offset Current

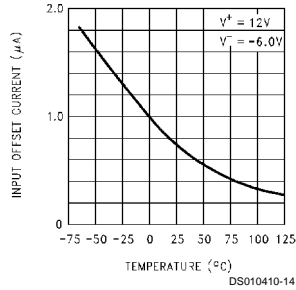

Supply Current

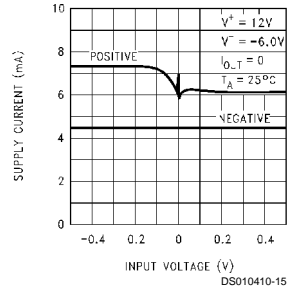

Response Time for Various Input Overdrives

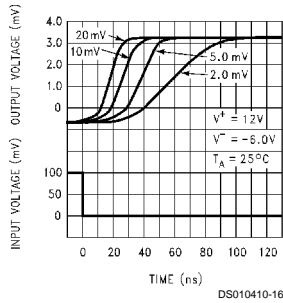

Response Time for Various Input Overdrives

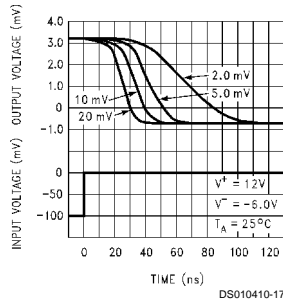

Common Mode Pulse Response

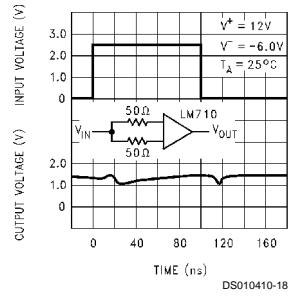

Typical Performance Characteristics (Continued)

Output Voltage Level

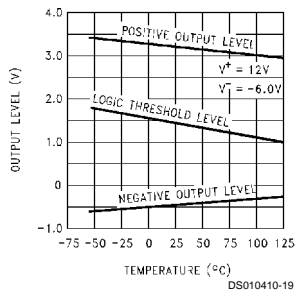

Output Sink Current

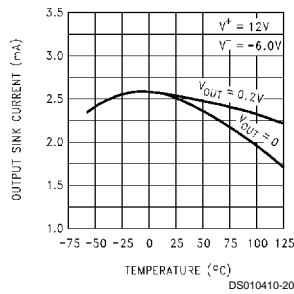

Maximum Power Dissipation

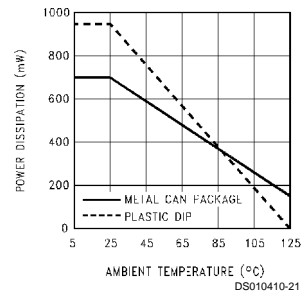

Book
Extract
End

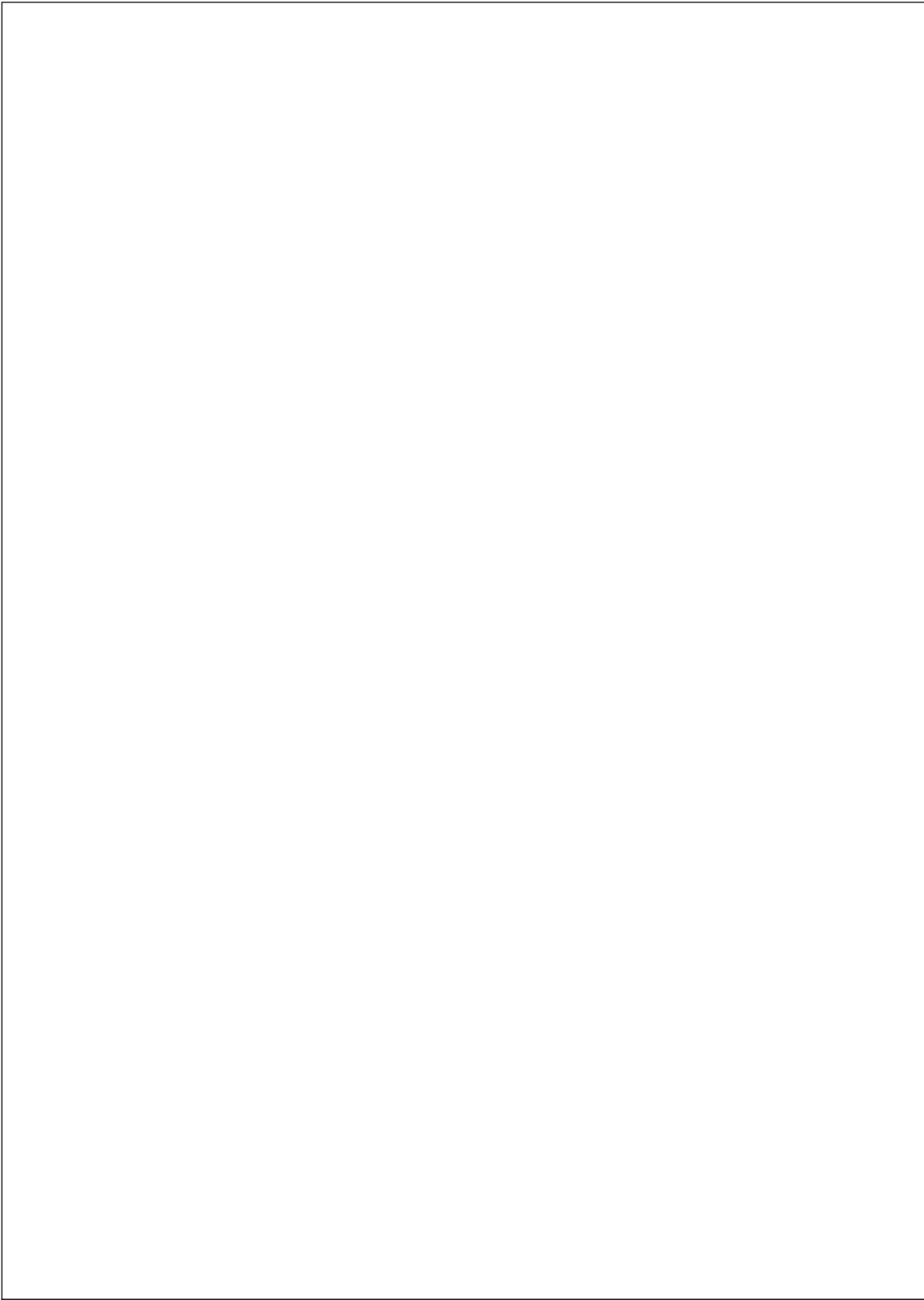

Physical Dimensions inches (millimeters)

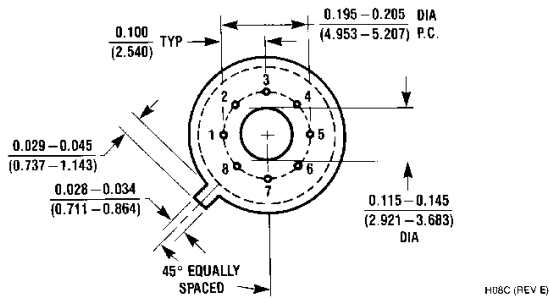
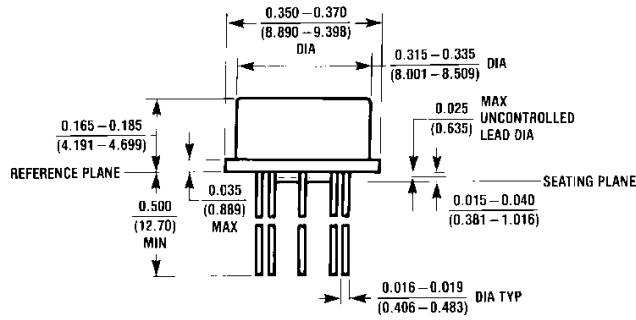

Metal Can Package
 Order Number LM710AMH/883, LM710H, LM710H/883 or LM710CH
 NS Package Number H08C

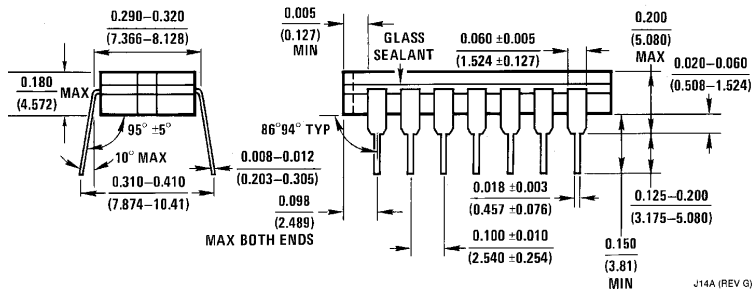
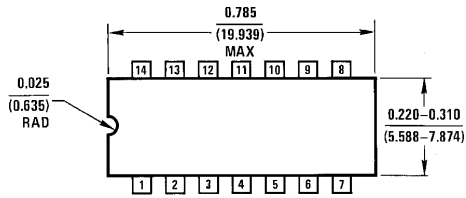

Ceramic Dual-In-Line Package
 Order Number LM710AMJ/883
 NS Package Number J14A

Physical Dimensions inches (millimeters) (Continued)

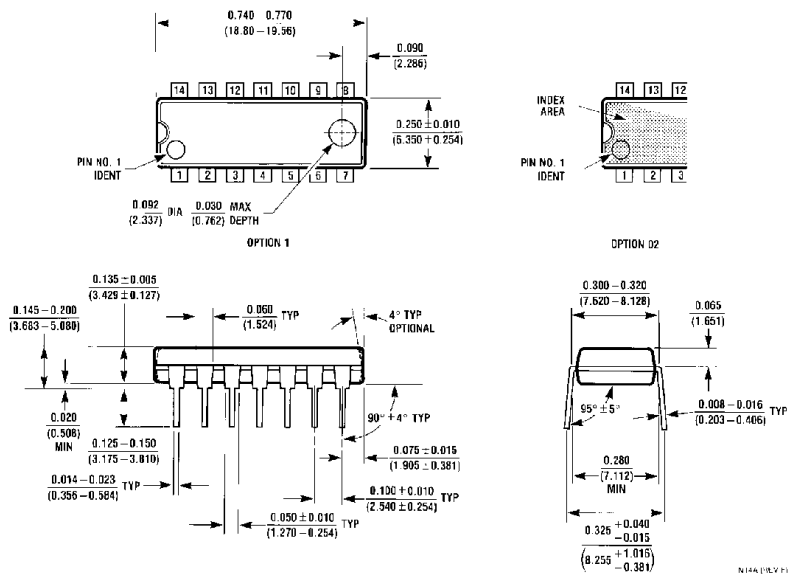

Molded Dual-In-Line Package (N)
Order Number LM710CN
NS Package Number N14A

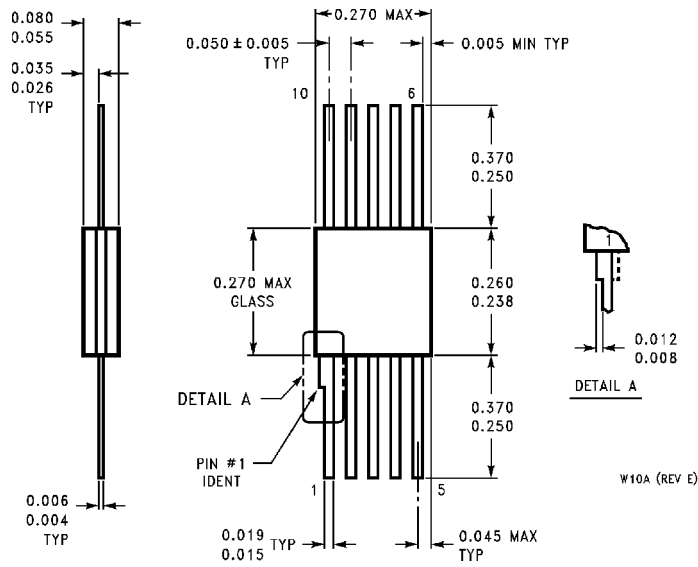

Ceramic Flatpak
Order Number LM710AMW/883
NS Package Number W10A

LIFE SUPPORT POLICY

NATIONAL'S PRODUCTS ARE NOT AUTHORIZED FOR USE AS CRITICAL COMPONENTS IN LIFE SUPPORT DEVICES OR SYSTEMS WITHOUT THE EXPRESS WRITTEN APPROVAL OF THE PRESIDENT OF NATIONAL SEMICONDUCTOR CORPORATION. As used herein:

1. Life support devices or systems are devices or systems which, (a) are intended for surgical implant into the body, or (b) support or sustain life, and whose failure to perform when properly used in accordance with instructions for use provided in the labeling, can be reasonably expected to result in a significant injury to the user.
2. A critical component in any component of a life support device or system whose failure to perform can be reasonably expected to cause the failure of the life support device or system, or to affect its safety or effectiveness.



National Semiconductor Corporation
 1111 West Bardin Road
 Arlington, TX 76017
 Tel: 1(800) 272-9959
 Fax: 1(800) 737-7018

www.national.com

National Semiconductor Europe

Fax: (+49) 0-180-530 85 86
 Email: cnjwge@tevm2.nsc.com
 Deutsch Tel: (+49) 0-180-530 85 85
 English Tel: (+49) 0-180-532 78 32
 Français Tel: (+49) 0-180-532 93 58
 Italiano Tel: (+49) 0-180-534 16 80

National Semiconductor Hong Kong Ltd.

13th Floor, Straight Block,
 Ocean Centre, 5 Canton Rd.
 Tsimshatsui, Kowloon
 Hong Kong
 Tel: (852) 2737-1600
 Fax: (852) 2736-9960

National Semiconductor Japan Ltd.

Tel: 81-043-299-2308
 Fax: 81-043-299-2408

National does not assume any responsibility for use of any circuitry described, no circuit patent licenses are implied and National reserves the right at any time without notice to change said circuitry and specifications.