

## FLORENCE-1R-Z60

~60° + 110° medium beam

### SPECIFICATION:

Dimensions	19.5 x 286.0 mm
Height	7.6 mm
Fastening	clips
ROHS compliant	yes ⓘ

### MATERIALS:

Component	Type	Material	Colour	Finish
FLORENCE-1R-Z60	Linear lens	PMMA	clear	

### ORDERING INFORMATION:



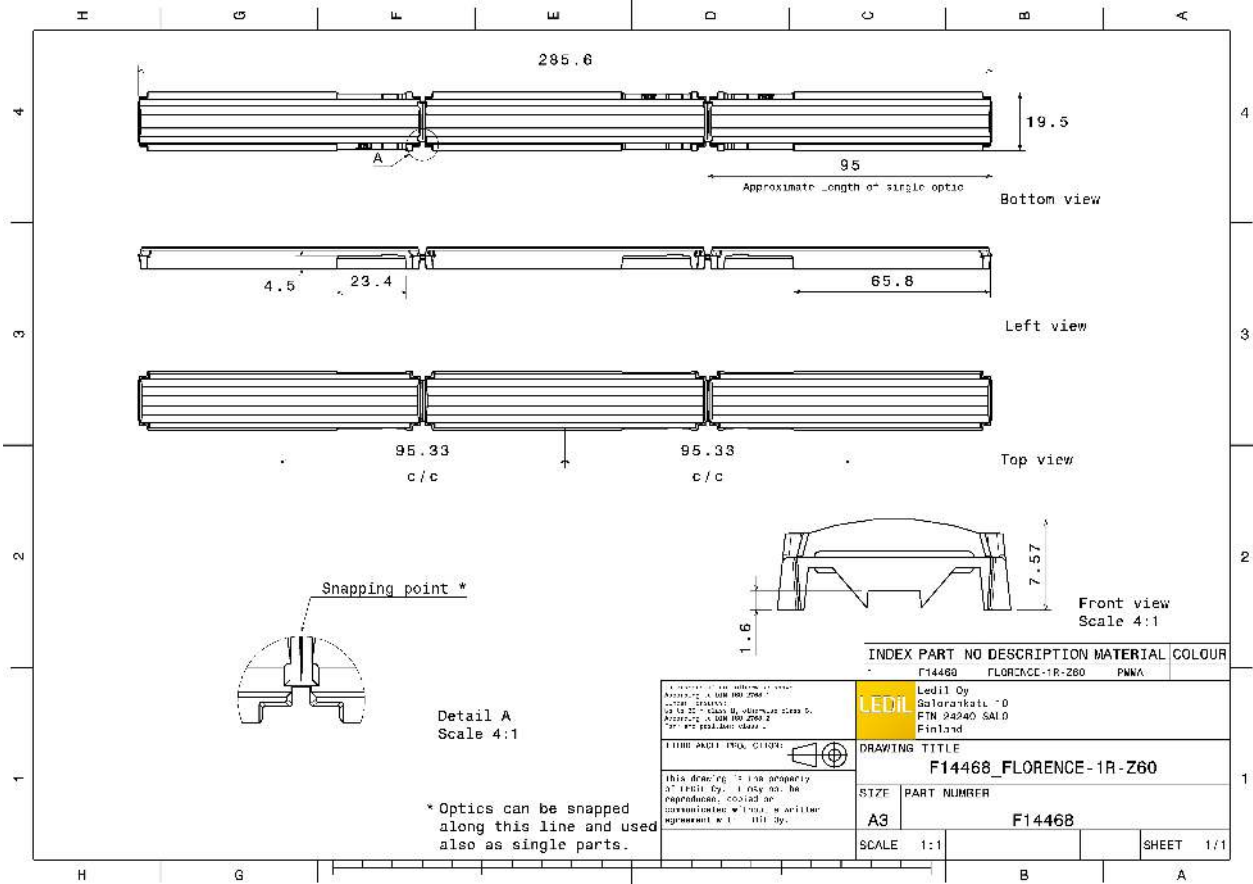

Component	Qty in box	MOQ	MPQ	Box weight (kg)
F14468_FLORENCE-1R-Z60 » Box size: 398 x 298 x 265 mm	165	45	15	7.1





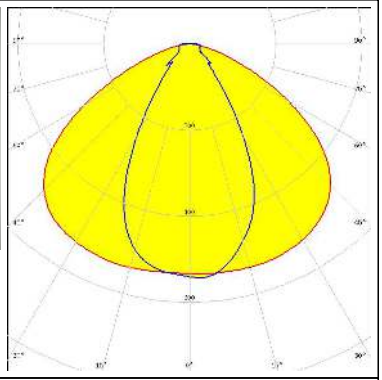

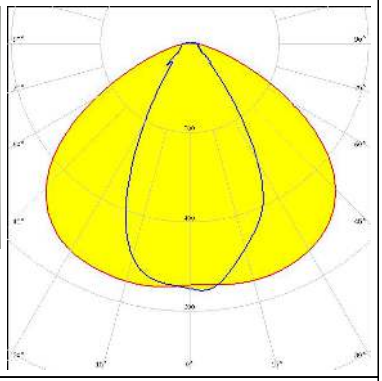
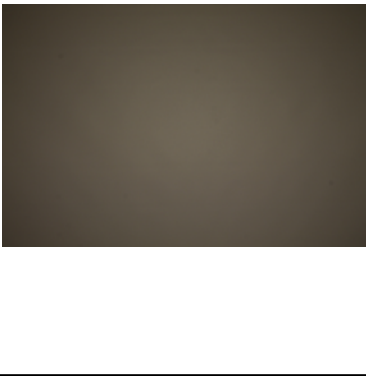
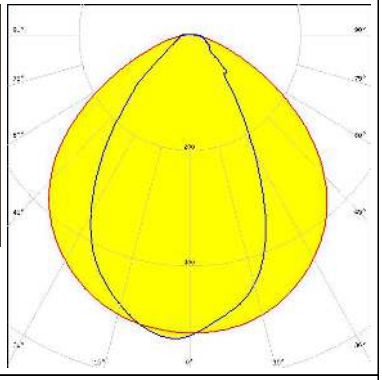

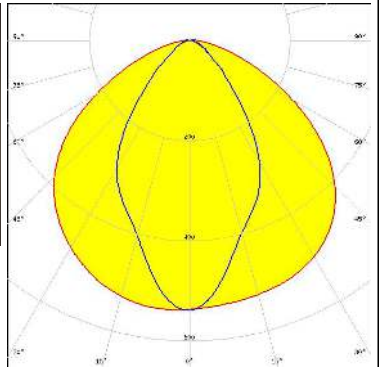
See also our general installation guide: [www.ledil.com/installation\\_guide](http://www.ledil.com/installation_guide)



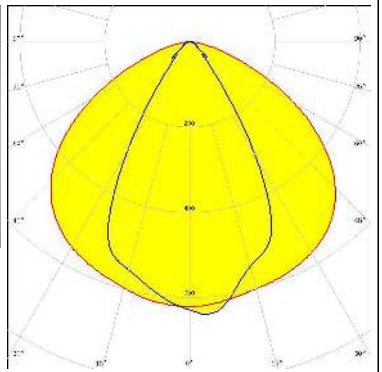

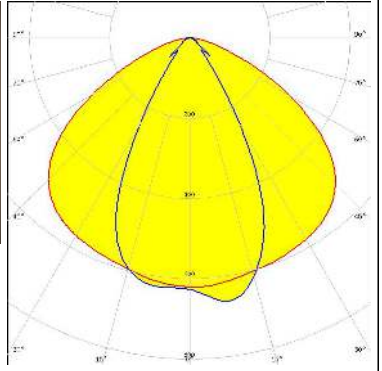
#### OPTICAL RESULTS (MEASURED):

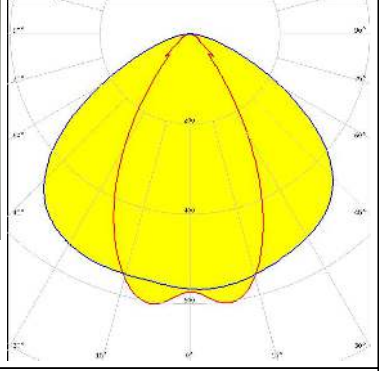
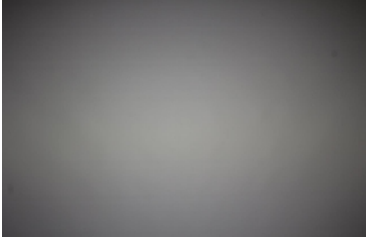
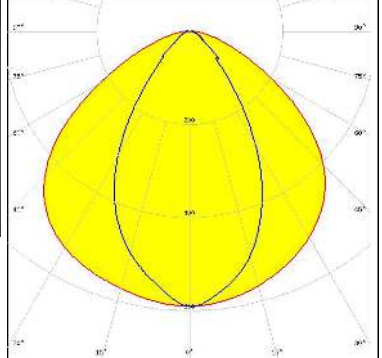
<p><b>aled</b></p> <p>LED CALGD0414-M8W1</p> <p>FWHM / FWTM 58.0 + 121.0° / 99.0 + 153.0°</p> <p>Efficiency 94 %</p> <p>Peak intensity 0.6 cd/lm</p> <p>LEDs/each optic 1</p> <p>Light colour White</p> <p>Required components:</p>		
<p><b>aled</b></p> <p>LED CALGD0814-M17W1</p> <p>FWHM / FWTM 57.0 + 118.0° / 99.0 + 152.0°</p> <p>Efficiency 92 %</p> <p>Peak intensity 0.6 cd/lm</p> <p>LEDs/each optic 1</p> <p>Light colour White</p> <p>Required components:</p>		
<p><b>CEZOS</b></p> <p>LED L0-280024-xxx-C0800-L267</p> <p>FWHM / FWTM 65.0 + 107.0° / 107.0 + 148.0°</p> <p>Efficiency 93 %</p> <p>Peak intensity 0.5 cd/lm</p> <p>LEDs/each optic 1</p> <p>Light colour White</p> <p>Required components:</p>		
<p><b>CREE LED</b></p> <p>LED XH-B/G</p> <p>FWHM / FWTM 63.0 + 113.0° / 105.0 + 155.0°</p> <p>Efficiency 94 %</p> <p>Peak intensity 0.5 cd/lm</p> <p>LEDs/each optic 1</p> <p>Light colour White</p> <p>Required components:</p>		



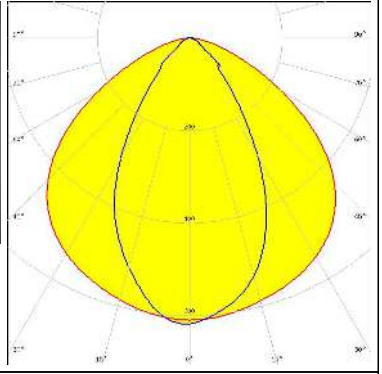

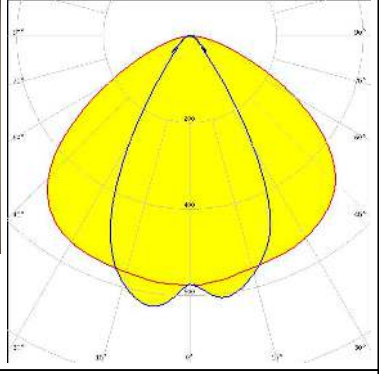
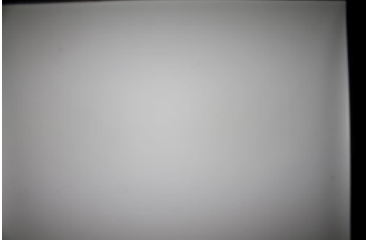
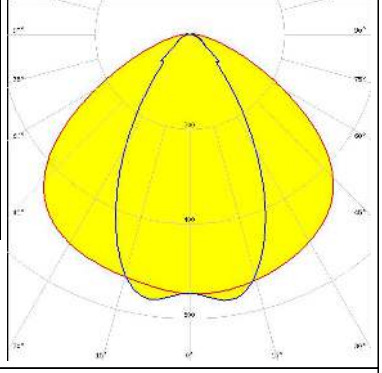
#### OPTICAL RESULTS (MEASURED):

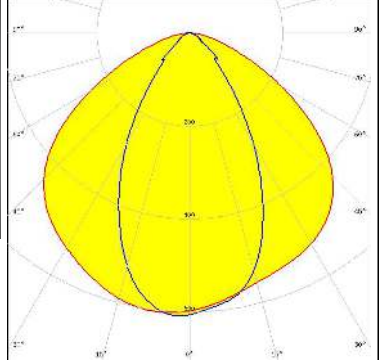
<p><b>LUMILEDS</b></p> <p>LED LUXEON 3014</p> <p>FWHM / FWTM 59.0 + 115.0° / 82.0 + 151.0°</p> <p>Efficiency 94 %</p> <p>Peak intensity 0.6 cd/lm</p> <p>LEDs/each optic 1</p> <p>Light colour White</p> <p>Required components:</p>		
<p><b>LUMILEDS</b></p> <p>LED LUXEON 3020</p> <p>FWHM / FWTM 55.0 + 117.0° / 96.0 + 151.0°</p> <p>Efficiency 94 %</p> <p>Peak intensity 0.7 cd/lm</p> <p>LEDs/each optic 1</p> <p>Light colour White</p> <p>Required components:</p>		
<p><b>LUMILEDS</b></p> <p>LED LUXEON 3030 2D (Round LES)</p> <p>FWHM / FWTM 57.0 + 114.0° / 97.0 + 150.0°</p> <p>Efficiency 94 %</p> <p>Peak intensity 0.6 cd/lm</p> <p>LEDs/each optic 1</p> <p>Light colour White</p> <p>Required components:</p>		
<p><b>LUMILEDS</b></p> <p>LED LUXEON 3535 2D</p> <p>FWHM / FWTM 60.0 + 109.0° / 100.0 + 150.0°</p> <p>Efficiency 94 %</p> <p>Peak intensity 0.6 cd/lm</p> <p>LEDs/each optic 1</p> <p>Light colour White</p> <p>Required components:</p>		

#### OPTICAL RESULTS (MEASURED):

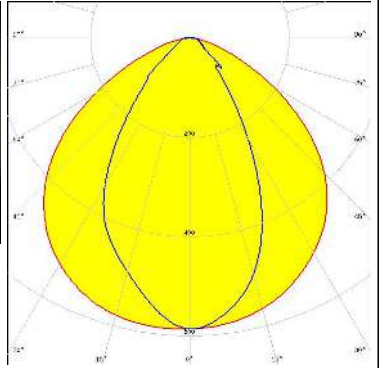
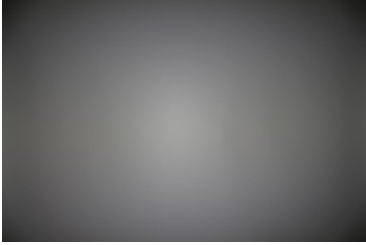
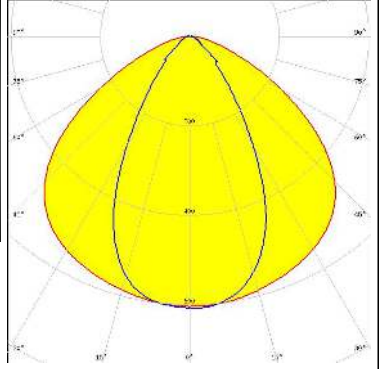
<p><b>LUMILEDS</b></p> <p>LED LUXEON 3535L</p> <p>FWHM / FWTM 59.0 + 110.0° / 99.0 + 149.0°</p> <p>Efficiency 94 %</p> <p>Peak intensity 0.6 cd/lm</p> <p>LEDs/each optic 1</p> <p>Light colour White</p> <p>Required components:</p>		
<p><b>LUMINUS</b></p> <p>LED MP-2016</p> <p>FWHM / FWTM 58.0 + 115.0° / 82.0 + 157.0°</p> <p>Efficiency 94 %</p> <p>Peak intensity 0.6 cd/lm</p> <p>LEDs/each optic 1</p> <p>Light colour White</p> <p>Required components:</p>		
<p><b>NICHIA</b></p> <p>LED NF2x757D</p> <p>FWHM / FWTM 59.0 + 114.0° / 101.0 + 152.0°</p> <p>Efficiency 94 %</p> <p>Peak intensity 0.6 cd/lm</p> <p>LEDs/each optic 1</p> <p>Light colour White</p> <p>Required components:</p>		
<p><b>NICHIA</b></p> <p>LED NF2x757G</p> <p>FWHM / FWTM 56.0 + 111.0° / 98.0 + 150.0°</p> <p>Efficiency 93 %</p> <p>Peak intensity 0.6 cd/lm</p> <p>LEDs/each optic 1</p> <p>Light colour White</p> <p>Required components:</p>		

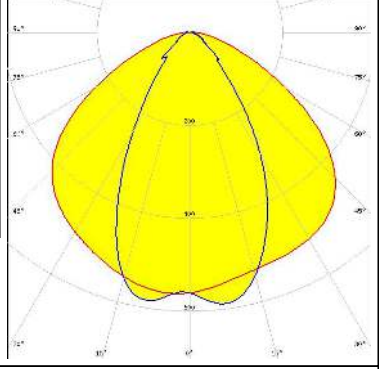
#### OPTICAL RESULTS (MEASURED):

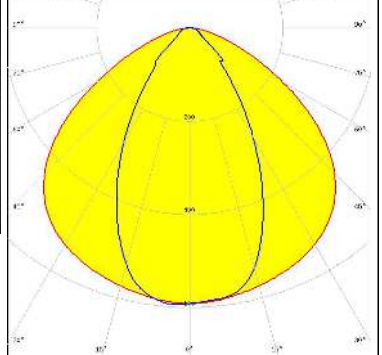
<p><b>NICHIA</b></p> <p>LED NFSW757H</p> <p>FWHM / FWTM 107.0 + 60.0° / 148.0 + 104.0°</p> <p>Efficiency 94 %</p> <p>Peak intensity 0.6 cd/lm</p> <p>LEDs/each optic 1</p> <p>Light colour White</p> <p>Required components: C14353_FLORENCE-1R-CLIP-A</p>		
<p><b>OSRAM</b> Opto Semiconductors</p> <p>LED Duris E5</p> <p>FWHM / FWTM 112.0 + 58.0° / 149.0 + 99.0°</p> <p>Efficiency 94 %</p> <p>Peak intensity 0.6 cd/lm</p> <p>LEDs/each optic 1</p> <p>Light colour White</p> <p>Required components:</p>		
<p><b>OSRAM</b> Opto Semiconductors</p> <p>LED Duris S5 (2 chip)</p> <p>FWHM / FWTM 58.0 + 114.0° / 100.0 + 154.0°</p> <p>Efficiency 94 %</p> <p>Peak intensity 0.6 cd/lm</p> <p>LEDs/each optic 1</p> <p>Light colour White</p> <p>Required components:</p>		
<p><b>PHILIPS</b></p> <p>LED Fortimo LED Line 1ft HF 1R HV5</p> <p>FWHM / FWTM 112.0 + 58.0° / 151.0 + 101.0°</p> <p>Efficiency 97 %</p> <p>Peak intensity 0.6 cd/lm</p> <p>LEDs/each optic 1</p> <p>Light colour White</p> <p>Required components: C14353_FLORENCE-1R-CLIP-A</p>		

#### OPTICAL RESULTS (MEASURED):

### PHILIPS

LED Fortimo LED Line 1ft MF 1R HV5 & LV5  
 FWHM / FWTM 112.0 + 59.0° / 151.0 + 100.0°  
 Efficiency 97 %  
 Peak intensity 0.6 cd/lm  
 LEDs/each optic 1  
 Light colour White  
 Required components:  
 C14353\_FLORENCE-1R-CLIP-A

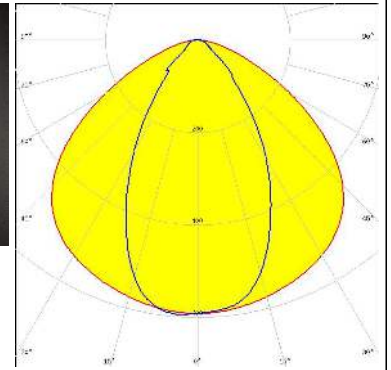

### SAMSUNG

LED LM28xB Series  
 FWHM / FWTM 57.0 + 113.0° / 98.0 + 150.0°  
 Efficiency 94 %  
 Peak intensity 0.6 cd/lm  
 LEDs/each optic 1  
 Light colour White  
 Required components:

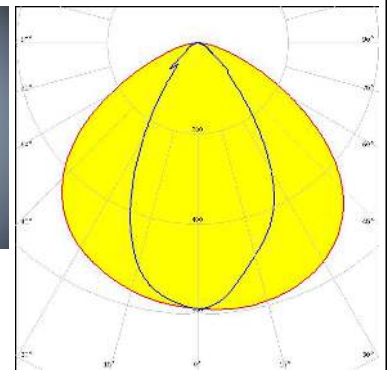
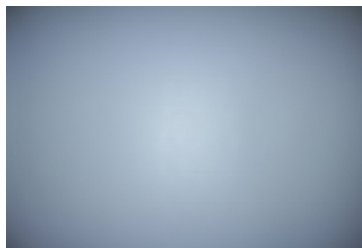

### SAMSUNG

LED LM28xB Series  
 FWHM / FWTM 111.0 + 59.0° / 150.0 + 101.0°  
 Efficiency 94 %  
 Peak intensity 0.6 cd/lm  
 LEDs/each optic 1  
 Light colour White  
 Required components:  
 C14409\_FLORENCE-1R-CLIP-B

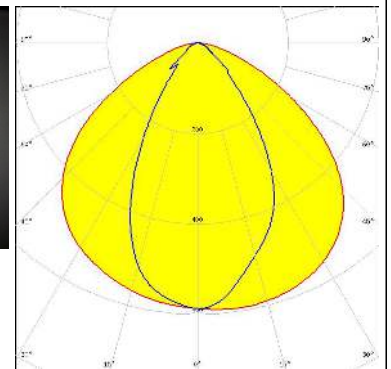

### SAMSUNG

LED LM301A  
 FWHM / FWTM 56.0 + 113.0° / 98.0 + 151.0°  
 Efficiency 94 %  
 Peak intensity 0.6 cd/lm  
 LEDs/each optic 1  
 Light colour White  
 Required components:

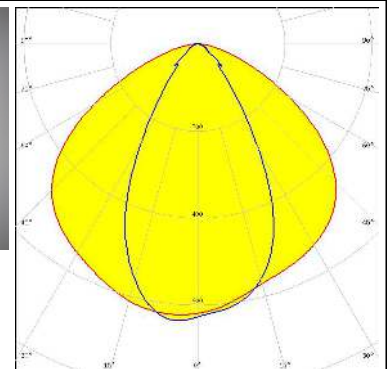
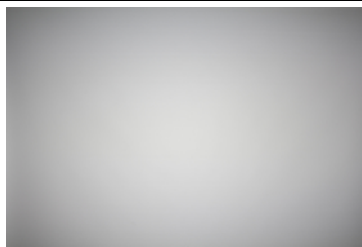

#### OPTICAL RESULTS (MEASURED):

#### SAMSUNG

LED LM302A  
 FWHM / FWTM 59.0 + 111.0° / 99.0 + 151.0°  
 Efficiency 94 %  
 Peak intensity 0.6 cd/lm  
 LEDs/each optic 1  
 Light colour White  
 Required components:

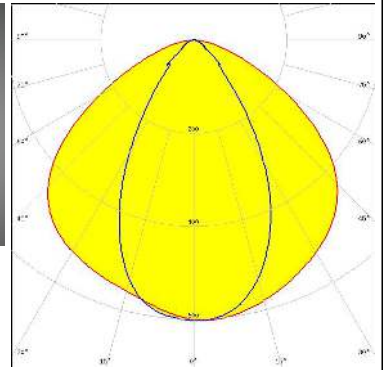

#### SAMSUNG

LED LM561B  
 FWHM / FWTM 59.0 + 111.0° / 100.0 + 151.0°  
 Efficiency 94 %  
 Peak intensity 0.6 cd/lm  
 LEDs/each optic 1  
 Light colour White  
 Required components:

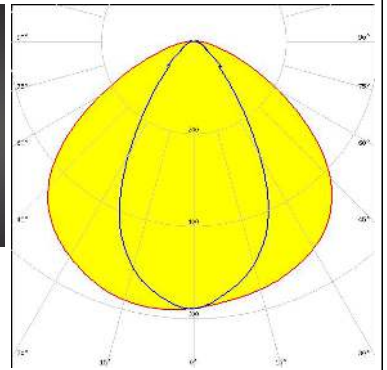
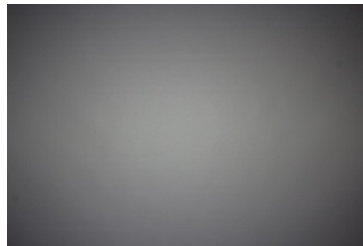

#### SAMSUNG

LED LM561B Plus  
 FWHM / FWTM 117.0 + 58.0° / 151.0 + 100.0°  
 Efficiency 94 %  
 Peak intensity 0.6 cd/lm  
 LEDs/each optic 1  
 Light colour White  
 Required components:  
 C14353\_FLORENCE-1R-CLIP-A

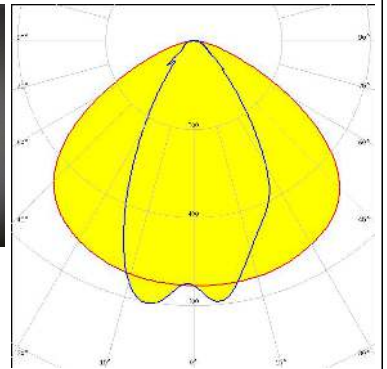

#### SAMSUNG

LED LM561C  
 FWHM / FWTM 56.0 + 113.0° / 98.0 + 149.0°  
 Efficiency 94 %  
 Peak intensity 0.6 cd/lm  
 LEDs/each optic 1  
 Light colour White  
 Required components:

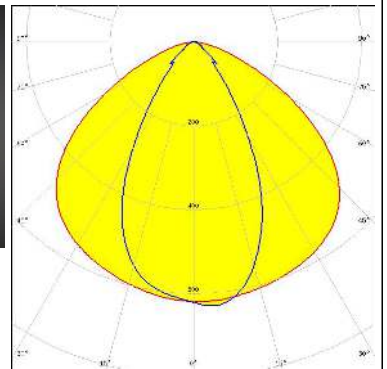
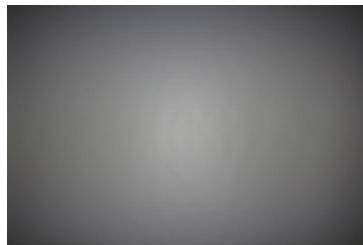



#### OPTICAL RESULTS (MEASURED):

### SAMSUNG

LED LT-S282N  
 FWHM / FWTM 56.0 + 112.0° / 99.0 + 149.0°  
 Efficiency 94 %  
 Peak intensity 0.6 cd/lm  
 LEDs/each optic 1  
 Light colour White  
 Required components:

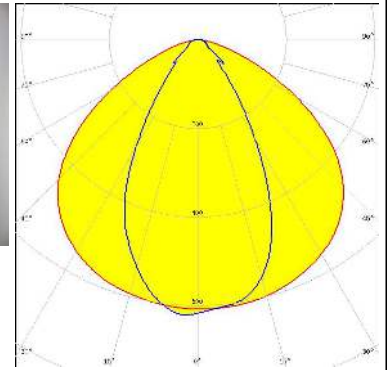

LED SEOUL 3030  
 FWHM / FWTM 59.0 + 111.0° / 98.0 + 150.0°  
 Efficiency 94 %  
 Peak intensity 0.6 cd/lm  
 LEDs/each optic 1  
 Light colour White  
 Required components:

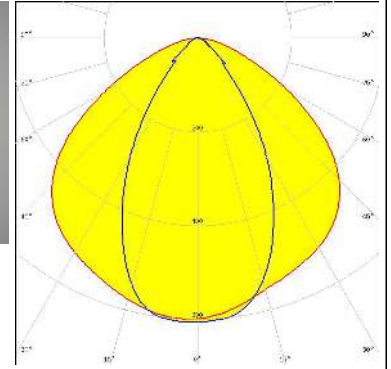

LED SEOUL DC 3030  
 FWHM / FWTM 115.0 + 55.0° / 150.0 + 98.0°  
 Efficiency 94 %  
 Peak intensity 0.6 cd/lm  
 LEDs/each optic 1  
 Light colour White  
 Required components:  
 C14353\_FLORENCE-1R-CLIP-A

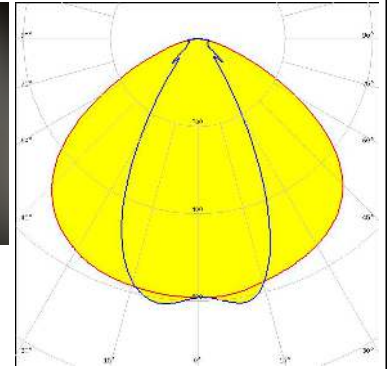

#### OPTICAL RESULTS (SIMULATED):

##### LUMILEDS

LED LUXEON 2835 Line  
 FWHM / FWTM 59.0 + 107.0° / 86.0 + 146.0°  
 Efficiency 94 %  
 Peak intensity 0.7 cd/lm  
 LEDs/each optic 1  
 Light colour White  
 Required components:

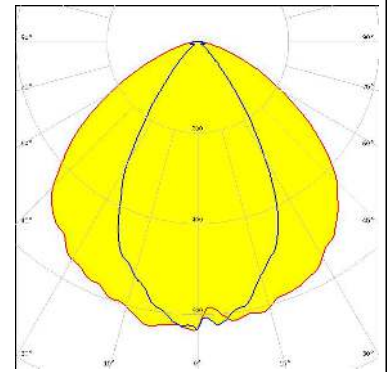

##### LUMILEDS

LED LUXEON 5050 Round LES  
 FWHM / FWTM 61.0 + 107.0° / 103.0 + 146.0°  
 Efficiency 94 %  
 Peak intensity 0.6 cd/lm  
 LEDs/each optic 1  
 Light colour White  
 Required components:

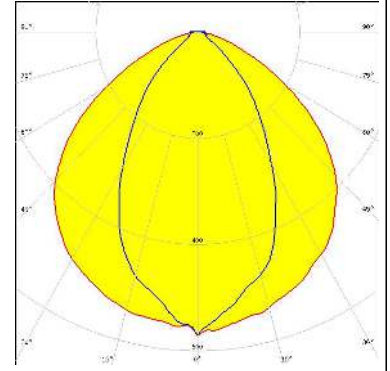

##### OSRAM

Opto Semiconductors  
 LED Duris E 2835  
 FWHM / FWTM 61.0 + 107.0° / 95.0 + 147.0°  
 Efficiency 94 %  
 Peak intensity 0.6 cd/lm  
 LEDs/each optic 1  
 Light colour White  
 Required components:

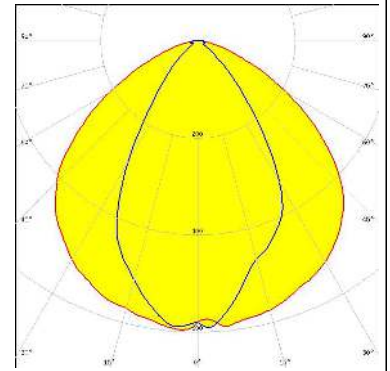

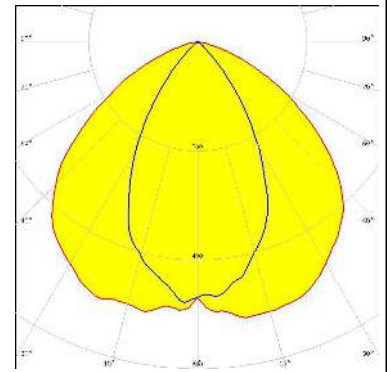

##### OSRAM

Opto Semiconductors  
 LED Duris E5  
 FWHM / FWTM 108.0 + 58.0° / 144.0 + 88.0°  
 Efficiency 75 %  
 Peak intensity 0.5 cd/lm  
 LEDs/each optic 1  
 Light colour White  
 Required components:  
 C14593\_FLORENCE-1R-SHD-BLK

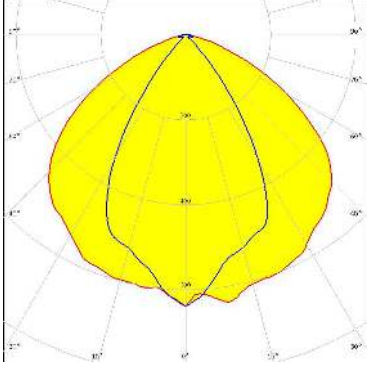

#### OPTICAL RESULTS (SIMULATED):

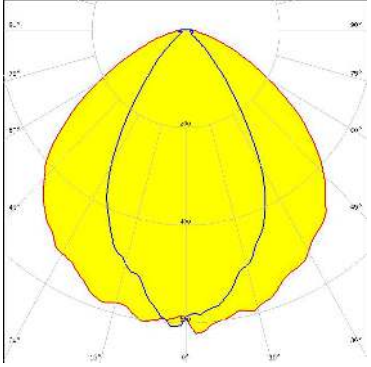
 OSRAM Opto Semiconductors	LED OSCONIQ C 2424 FWHM / FWTM 112.0 + 61.0° / 146.0 + 83.0° Efficiency 96 % Peak intensity 0.6 cd/lm LEDs/each optic 1 Light colour White Required components:	
 SEOUL SEMICONDUCTOR	LED SEOUL DC 3030C FWHM / FWTM 107.0 + 62.0° / 147.0 + 94.0° Efficiency 95 % Peak intensity 0.6 cd/lm LEDs/each optic 1 Light colour White Required components:	

### GENERAL INFORMATION:

NOTE: The typical beam angle will be changed by different color, chip size and chip position tolerance. The typical total beam angle is the full angle measured where the luminous intensity is half of the peak value.

### MATERIALS:

As part of our continuous research and improvement processes, and to ensure the best possible quality and availability of our products, LEDiL reserves the right to change material grades without notice.

### PRODUCT DATA USER AGREEMENT AND DISCLAIMER:

The measured data in the provided downloadable LEDiL Product Datasheets and Mechanical 2D-Drawings is rounded and provided as reference for planning. LEDiL Oy's optical specifications have been verified by conducting performance testing of the products in accordance with the company's quality system. The reported data are averaged results of multiple measurements with typical variation. LEDiL Oy reserves the right to without prior notification make changes and improvements to its products.

LEDiL Oy assumes neither warranty, nor guarantee nor any other liability of any kind for the contents and correctness of the provided data. The provided data has been generated with highest diligence but the provided data may in reality not represent the complete possible variation range of all intrinsic parameters. Therefore, in certain cases a deviation from the provided data could occur.

LEDiL Oy reserves the right to undertake technical changes of its products without further notification which could lead to changes in the provided data. LEDiL Oy assumes no liability of any kind for the possible deviation from any provided data or any other damage resulting from the usage of the provided data.

The user agrees to this disclaimer and user agreement with the download or usage of the provided files.

#### LEDiL Oy

Joensuunkatu 13  
FI-24240 SALO  
Finland

#### LEDiL Inc.

228 West Page Street  
Suite D  
Sycamore IL 60178  
USA

#### Ledil Optics Technology (Shenzhen) Co., Ltd.

# 405 , Block B  
Casic Motor Building  
Shenzhen 518057  
P.R.CHINA

#### Local sales and technical support

[www.ledil.com/  
where\\_to\\_buy](http://www.ledil.com/where_to_buy)

#### Shipping locations

Salo, Finland  
Hong Kong, China

#### Distribution Partners

[www.ledil.com/  
where\\_to\\_buy](http://www.ledil.com/where_to_buy)