

OBSOLETE – PART DISCONTINUED

Description

The AP3405 is a 2.0MHz fixed frequency, current mode, PWM synchronous buck (step-down) DC-DC converter, capable of driving a 600mA load with high efficiency, excellent line and load regulation. The high efficiency is easily configured by using an inductor, resistors and capacitors as the external components. Current mode control provides fast transient response and cycle-by-cycle current limit.

The AP3405 employs complete protection to ensure system security, including input Undervoltage Lockout, Over-Temperature Protection and hiccup mode Short Circuit Protection.

This IC is available in U-DFN2020-8 package.

Pin Assignments

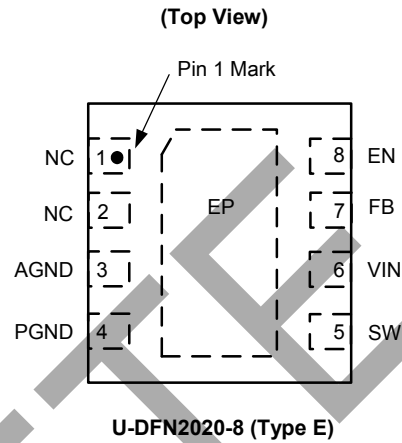

Features

- High-Efficiency Buck Power Converter
- Input Voltage Range: 2.3V to 5.5V
- Output Voltage Range: 0.7V to 5.5V
- Fixed 2.0MHz Oscillator Frequency
- Built-in Soft-Start Time
- Built-in Overcurrent Protection
- Built-in Thermal Shutdown Function
- Built-in UVLO Function
- Hiccup Mode SCP
- Output Current: 600mA
- Package: U-DFN2020-8 (Type E)
- **Totally Lead-Free & Fully RoHS Compliant (Notes 1 & 2)**
- **Halogen and Antimony Free. "Green" Device (Note 3)**

Applications

- Post DC-DC Voltage Regulation
- Mobile Phones and Wearable Devices

- Notes:
1. No purposely added lead. Fully EU Directive 2002/95/EC (RoHS) & 2011/65/EU (RoHS 2) compliant.
 2. See http://www.diodes.com/quality/lead_free.html for more information about Diodes Incorporated's definitions of Halogen- and Antimony-free, "Green" and Lead-free.
 3. Halogen- and Antimony-free "Green" products are defined as those which contain <900ppm bromine, <900ppm chlorine (<1500ppm total Br + Cl) and <1000ppm antimony compounds.

Typical Applications Circuit

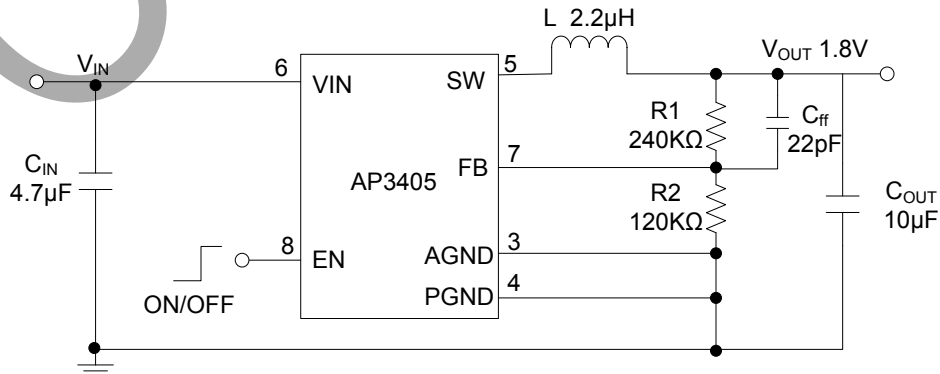

Pin Descriptions

Pin Number	Pin Name	Function
1, 2	NC	No connection
3	AGND	Signal Ground Pin
4	PGND	Power Ground Pin
5	SW	Power switch output pin. This pin is connected to the inductor.
6	VIN	Supply power input pin. A capacitor should be connected between VIN pin and GND - to keep the input voltage constant.
7	FB	Feedback pin. This pin is connected to an external resistor divider to program the system output voltage.
8	EN	Control input pin. EN is a digital input that turns the regulator on or off. Drive EN high to turn the regulator on. Drive low to turn the regulator off.

Functional Block Diagram

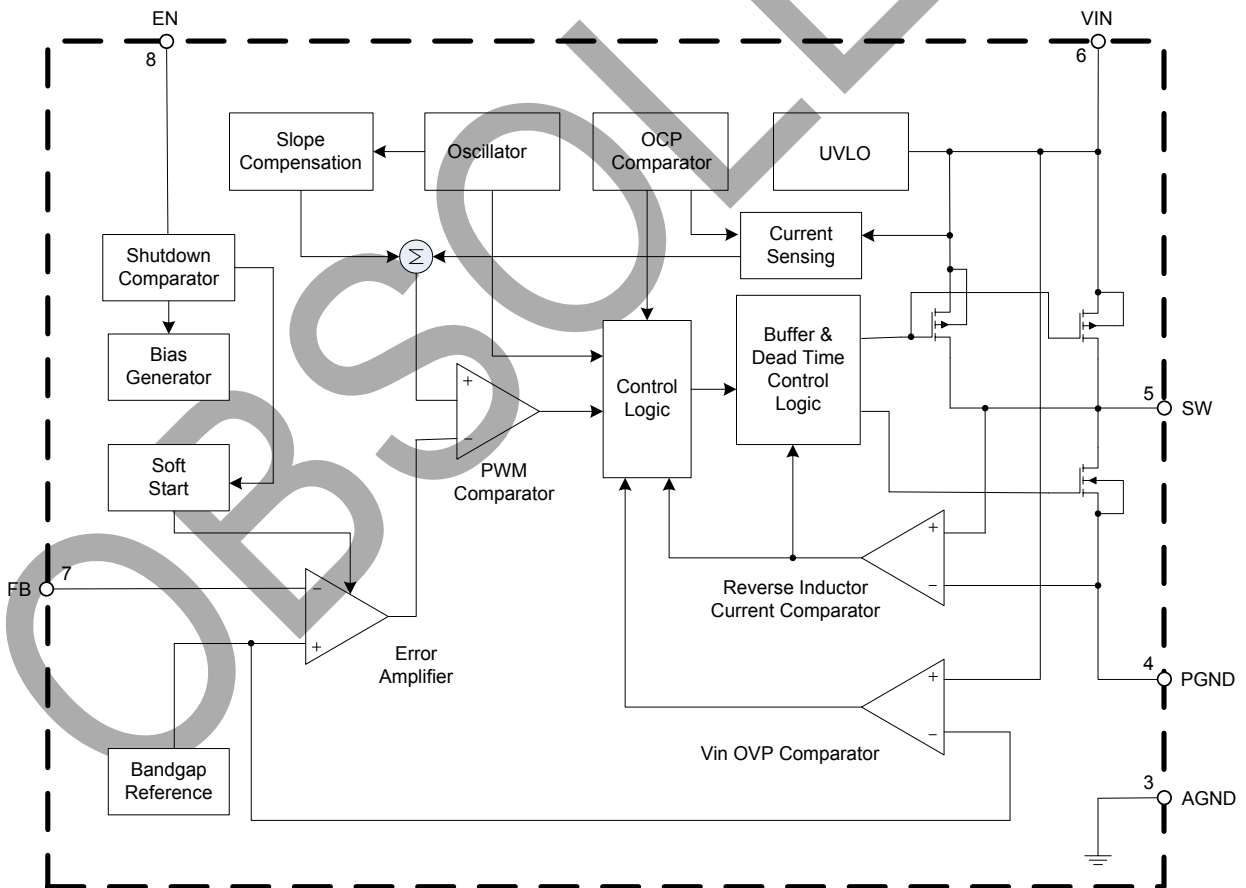

Absolute Maximum Ratings (@ $T_A = +25^\circ\text{C}$, unless otherwise specified.) (Note 4)

Symbol	Parameter	Rating	Unit
V_{IN}	VIN Input Voltage	-0.3 to 6.5	V
V_{SW}	SW Pin Voltage	-0.3 to $V_{IN} + 0.3$	V
V_{EN}	EN Pin Input Voltage	-0.3 to 6.5	V
V_{FB}	VFB Pin Voltage	-0.3 to 6.5	V
I_{SW}	SW Pin Output Current	1	A
P_D	Power Dissipation (Standard Land Pattern)	640	mW
T_{STG}	Storage Temperature Range	-55 to +125	$^\circ\text{C}$
V_{HBM}	ESD (Human Body Model)	2,000	V

Note: 4. Stresses greater than those listed under "Absolute Maximum Ratings" may cause permanent damage to the device. These are stress ratings only, and functional operation of the device at these or any other conditions beyond those indicated under "Recommended Operating Conditions" is not implied. Exposure to "Absolute Maximum Ratings" for extended periods may affect device reliability.

Recommended Operating Conditions (@ $T_A = +25^\circ\text{C}$, unless otherwise specified.)

Symbol	Parameter	Min	Max	Unit
V_{IN}	Input Voltage	2.3	5.5	V
T_A	Operating Ambient Temperature	-40	+85	$^\circ\text{C}$

Electrical Characteristics ($V_{IN} = V_{EN} = 3.6V$ ($V_{OUT} \leq 2.6V$), $V_{IN} = V_{EN} = V_{OUT}+1V$ ($V_{OUT} > 2.6V$), unless otherwise specified. Specification with standard typeface are for $T_A = +25^\circ C$, and those in boldface type apply over the full operating temperature range ($T_A = -40^\circ C$ to $+85^\circ C$))

Symbol	Parameter	Conditions	Min	Typ	Max	Unit
V_{IN}	Input Voltage	$1.0V \leq V_{OUT}$	2.3	–	5.5	V
		$0.9V \leq V_{OUT} < 1.0V$	2.3	–	5.25	
		$0.7V \leq V_{OUT} < 0.9V$	2.3	–	4.5	
I_{DD}	Supply Current	$V_{IN} = V_{EN} = V_{FB} = 3.6V$	–	32	45	μA
I_{STDB}	Standby Current	$V_{IN} = 5.5V, V_{EN} = 0V$	–	0	5	μA
V_{UVLO}	Input UVLO Threshold	V_{IN} Rising	2.0	2.1	2.2	V
V_{HYS}	Input UVLO Hysteresis	–	–	0.1	–	V
V_{ENH}	EN Active Threshold Voltage	$V_{IN} = 5.5V$	1.0	–	–	V
V_{ENL}	EN Shutdown Threshold Voltage	$V_{IN} = 2.3V$	–	–	0.4	V
V_{FB}	Feedback Voltage	$V_{IN} = V_{EN} = 3.6V$	0.591	0.600	0.609	V
I_{FBH}	FB High Input Current	$V_{IN} = V_{FB} = 5.5V$ $V_{EN} = 0V$	-1	0	1	μA
I_{FBL}	FB Low Input Current	$V_{EN} = V_{FB} = 0V$ $V_{IN} = 5.5V$	-1	0	1	μA
R_{ONH}	High-Side Switch On-Resistance	$V_{IN} = 3.6V$ $I_{SW} = 100mA$	–	380	–	$m\Omega$
R_{ONL}	Low-Side Switch On-Resistance	$V_{IN} = 3.6V$ $I_{SW} = 100mA$	–	300	–	$m\Omega$
I_{LIMH}	SW Current Limit	$V_{IN} = V_{EN} = 3.6V$	800	1,000	–	mA
f_{OSC}	Oscillator Frequency	–	1.7	2.0	2.3	MHz
D_{MAX}	Maximum Duty Cycle	–	100	–	–	%
T_{OTSD}	Thermal Shutdown	–	–	+140	–	$^\circ C$
T_{HYS}	Thermal Shutdown Hysteresis	–	–	+40	–	$^\circ C$
t_{SS}	Soft-Start Time	$V_{IN} = V_{EN} = 3.6V$	–	150	300	μs

OBSOLETE – PART DISCONTINUED

Performance Characteristics ($T_A = +25^\circ\text{C}$, $V_{IN} = 3.6\text{V}$, $V_{OUT} = 1.8\text{V}$, unless otherwise specified.)

Efficiency vs. Output Current

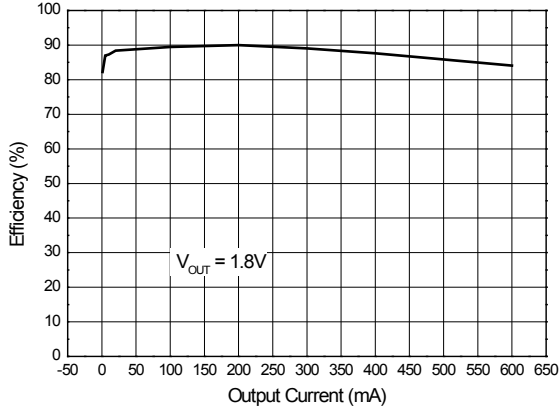

Output Voltage vs. Output Current

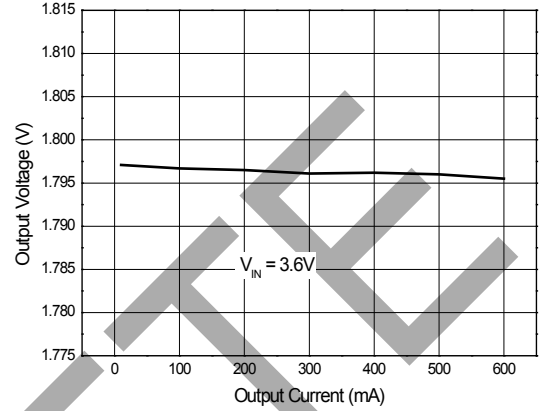

Supply Current vs. Input Voltage

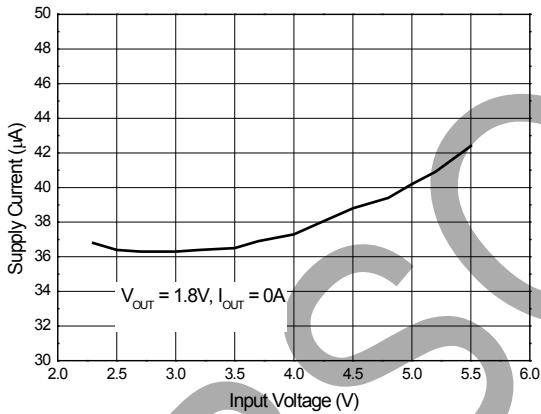

Feedback Voltage vs. Temperature

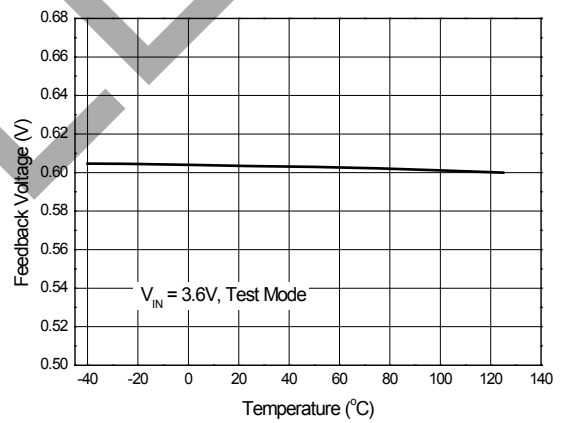

PMOS R_{DS(on)} vs. Temperature

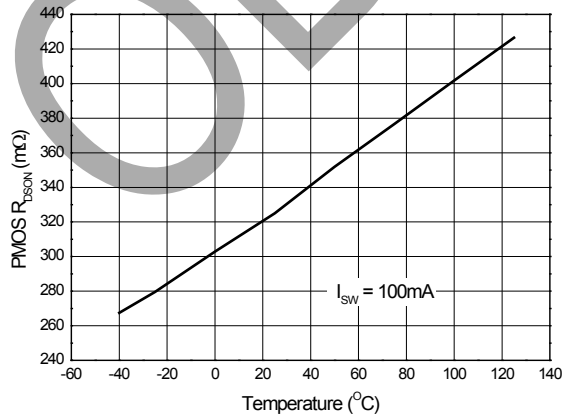

NMOS R_{DS(on)} vs. Temperature

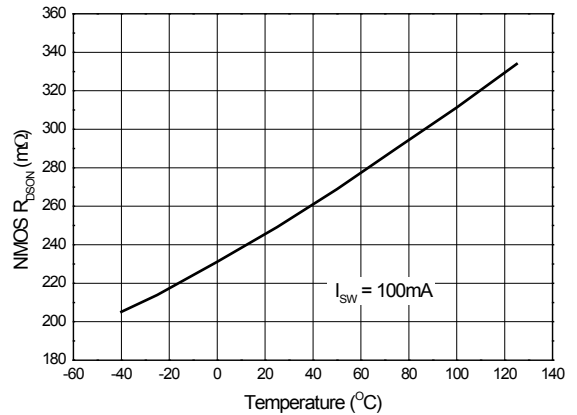

OBSOLETE - PART DISCONTINUED

Performance Characteristics (continued) ($T_A = +25^\circ\text{C}$, $V_{IN} = 3.6\text{V}$, $V_{OUT} = 1.8\text{V}$, unless otherwise specified.)

Output Ripple ($I_{OUT} = 0\text{A}$)

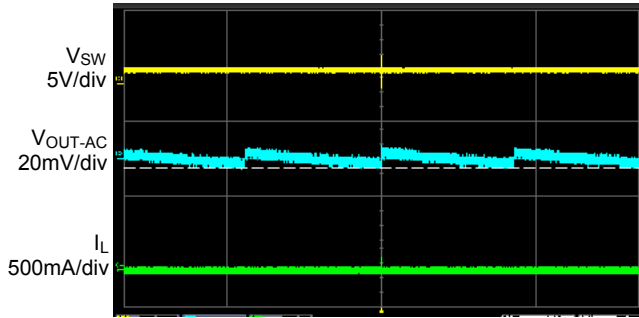

Time 1.6ms/div

Output Ripple ($I_{OUT} = 0.6\text{A}$)

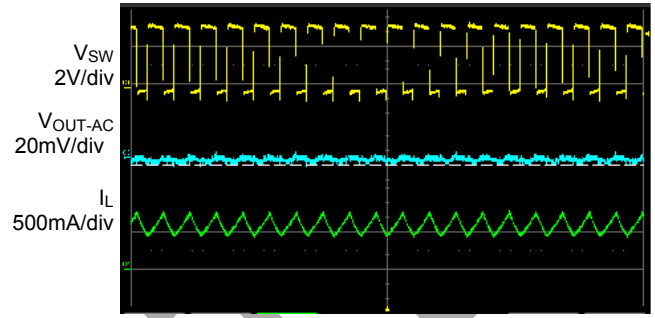

Time 1µs/div

**Enable Turn on Characteristic
(Resistance Load, $R_{LOAD} = 3\Omega$)**

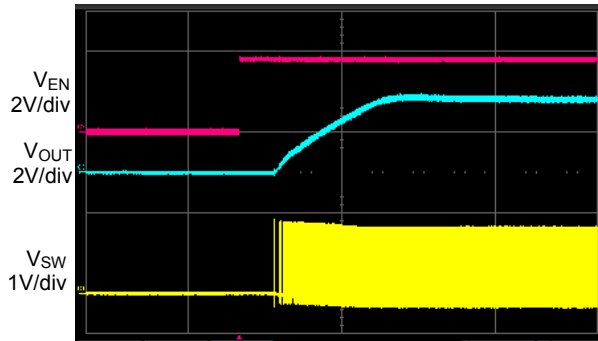

Time 50µs/div

**Enable Turn off Characteristic
(Resistance Load, $R_{LOAD} = 3\Omega$)**

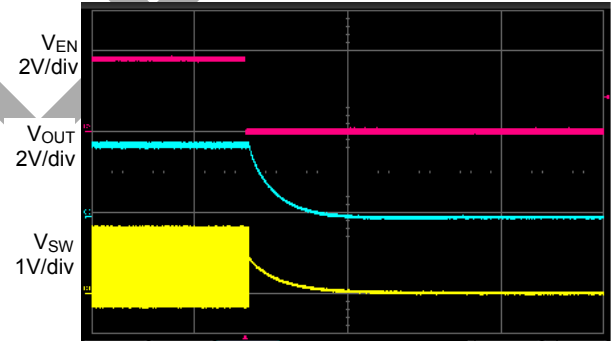

Time 50µs/div

**Short Current Protection
(Resistance Load, $R_{LOAD} = 3\Omega$)**

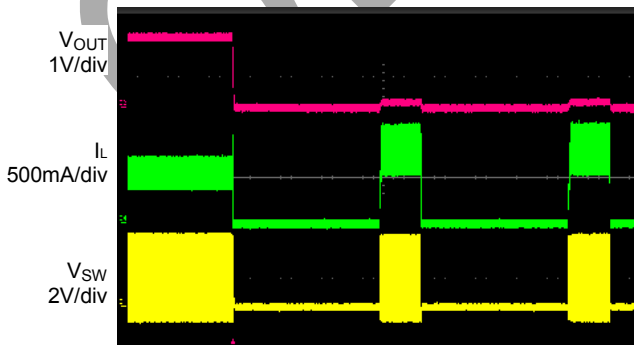

Time 200µs/div

**SCP Recovery
(Resistance Load, $R_{LOAD} = 3\Omega$)**

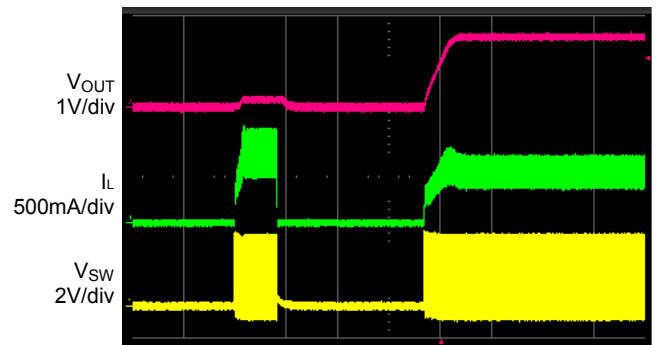

Time 200µs/div

OBSOLETE - PART DISCONTINUED

Application Information

Please refer to the Typical Applications Circuit, and to set the circuit parameters please refer to the following descriptions.

Undervoltage Lockout (UVLO) Circuit

When the V_{IN} drops lower than the UVLO detector threshold, the UVLO circuit starts to operate, V_{REF} stops, and high-side switch and low-side switch built-in switch transistors turn "OFF". As a result, V_{OUT} drops according to the C_{OUT} capacitance value and the load. When the V_{IN} is rising higher than UVLO released voltage, the IC will restart the operation.

Short Circuit Protection and Recovery

When the AP3405 output node is shorted to GND, as V_{FB} drops under 0.3V, the chip will enter hiccup mode to protect itself, when short circuit is removed, and V_{FB} rises over 0.4V, the AP3405 recovers to normal operation again. If the AP3405 reaches OCP threshold while short circuit, the AP3405 will enter cycle-by-cycle current limit mode until the current under OCP threshold.

Input Overvoltage Protection

When input voltage of AP3405 is near 6.25V, the IC will enter Input-Overvoltage-Protection. It would be shut down and there will be no output voltage in this state. As the input voltage goes down below 6V, it will leave input OVP and recover the output voltage.

Over-Temperature Protection

The internal thermal temperature protection circuitry is provided to protect the integrated circuit in the event that the maximum junction temperature is exceeded. When the junction temperature exceeds +140°C, it shuts down the internal control circuit and switching power MOSFET. The AP3405 will restart automatically under the control of soft start circuit when the junction temperature decreases to +100°C.

Ordering Information

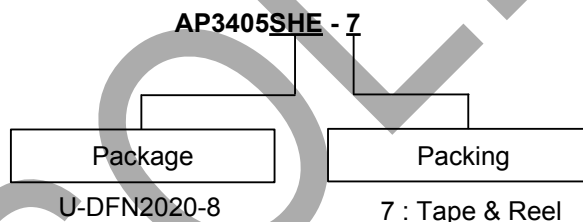

Device	Package Code	Packaging	7" Tape and Reel	
			Quantity	Part Number Suffix
AP3405SHE-7	SHE	U-DFN2020-8	3,000/Tape & Reel	-7

Marking Information

U-DFN2020-8 (Type E)

(Top View)

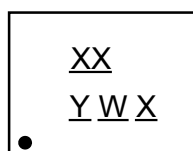

XX : Identification Code
Y : Year : 0~9
W : Week : A~Z : 1~26 week;
 a~z : 27~52 week; z represents
 52 and 53 week
X : Internal Code

Part Number	Package	Identification Code
AP3405SHE	U-DFN2020-8	2V

Package Outline Dimensions (All dimensions in mm.)

Please see AP02002 at <http://www.diodes.com/datasheets/ap02002.pdf> for the latest version.

(1) Package Type: U-DFN2020-8 (Type E)

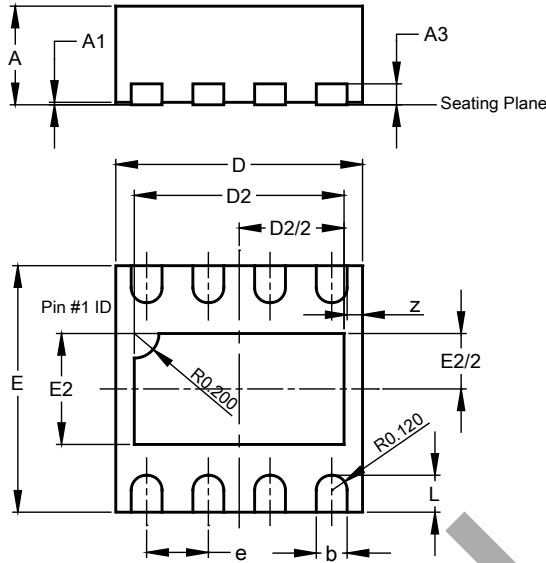

U-DFN2020-8 (Type E)			
Dim	Min	Max	Typ
A	0.50	0.60	0.56
A1	0.00	0.05	0.02
A3	-	-	0.203
b	0.20	0.30	0.25
D	1.950	2.075	2.00
D2	1.60	1.80	1.70
e	0.500 BSC		
E	1.950	2.075	2.00
E2	0.80	1.00	0.90
L	0.25	0.35	0.30
z	-	-	0.125
All Dimensions in mm			

Suggested Pad Layout

Please see AP02001 at <http://www.diodes.com/datasheets/ap02001.pdf> for the latest version.

(1) Package Type: U-DFN2020-8 (Type E)

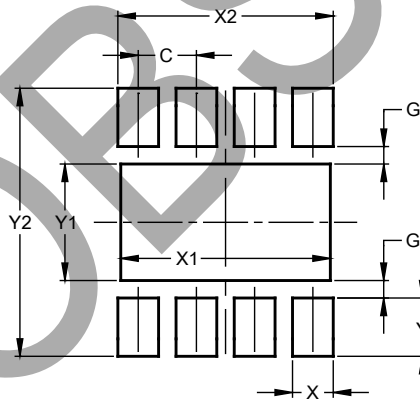

Dimensions	Value (in mm)
C	0.500
G	0.150
X	0.350
X1	1.800
X2	1.850
Y	0.500
Y1	1.000
Y2	2.300

OBSOLETE - PART DISCONTINUED

IMPORTANT NOTICE

1. DIODES INCORPORATED AND ITS SUBSIDIARIES (“DIODES”) MAKE NO WARRANTY OF ANY KIND, EXPRESS OR IMPLIED, WITH REGARDS TO ANY INFORMATION CONTAINED IN THIS DOCUMENT, INCLUDING, BUT NOT LIMITED TO, THE IMPLIED WARRANTIES OF MERCHANTABILITY, FITNESS FOR A PARTICULAR PURPOSE OR NON-INFRINGEMENT OF THIRD PARTY INTELLECTUAL PROPERTY RIGHTS (AND THEIR EQUIVALENTS UNDER THE LAWS OF ANY JURISDICTION).
2. The Information contained herein is for informational purpose only and is provided only to illustrate the operation of Diodes products described herein and application examples. Diodes does not assume any liability arising out of the application or use of this document or any product described herein. This document is intended for skilled and technically trained engineering customers and users who design with Diodes products. Diodes products may be used to facilitate safety-related applications; however, in all instances customers and users are responsible for (a) selecting the appropriate Diodes products for their applications, (b) evaluating the suitability of the Diodes products for their intended applications, (c) ensuring their applications, which incorporate Diodes products, comply the applicable legal and regulatory requirements as well as safety and functional-safety related standards, and (d) ensuring they design with appropriate safeguards (including testing, validation, quality control techniques, redundancy, malfunction prevention, and appropriate treatment for aging degradation) to minimize the risks associated with their applications.
3. Diodes assumes no liability for any application-related information, support, assistance or feedback that may be provided by Diodes from time to time. Any customer or user of this document or products described herein will assume all risks and liabilities associated with such use, and will hold Diodes and all companies whose products are represented herein or on Diodes’ websites, harmless against all damages and liabilities.
4. Products described herein may be covered by one or more United States, international or foreign patents and pending patent applications. Product names and markings noted herein may also be covered by one or more United States, international or foreign trademarks and trademark applications. Diodes does not convey any license under any of its intellectual property rights or the rights of any third parties (including third parties whose products and services may be described in this document or on Diodes’ website) under this document.
5. Diodes products are provided subject to Diodes’ Standard Terms and Conditions of Sale (<https://www.diodes.com/about/company/terms-and-conditions/terms-and-conditions-of-sales/>) or other applicable terms. This document does not alter or expand the applicable warranties provided by Diodes. Diodes does not warrant or accept any liability whatsoever in respect of any products purchased through unauthorized sales channel.
6. Diodes products and technology may not be used for or incorporated into any products or systems whose manufacture, use or sale is prohibited under any applicable laws and regulations. Should customers or users use Diodes products in contravention of any applicable laws or regulations, or for any unintended or unauthorized application, customers and users will (a) be solely responsible for any damages, losses or penalties arising in connection therewith or as a result thereof, and (b) indemnify and hold Diodes and its representatives and agents harmless against any and all claims, damages, expenses, and attorney fees arising out of, directly or indirectly, any claim relating to any noncompliance with the applicable laws and regulations, as well as any unintended or unauthorized application.
7. While efforts have been made to ensure the information contained in this document is accurate, complete and current, it may contain technical inaccuracies, omissions and typographical errors. Diodes does not warrant that information contained in this document is error-free and Diodes is under no obligation to update or otherwise correct this information. Notwithstanding the foregoing, Diodes reserves the right to make modifications, enhancements, improvements, corrections or other changes without further notice to this document and any product described herein. This document is written in English but may be translated into multiple languages for reference. Only the English version of this document is the final and determinative format released by Diodes.
8. Any unauthorized copying, modification, distribution, transmission, display or other use of this document (or any portion hereof) is prohibited. Diodes assumes no responsibility for any losses incurred by the customers or users or any third parties arising from any such unauthorized use.

Copyright © 2021 Diodes Incorporated

www.diodes.com