

Intel[®] 6 Series Chipset and Intel[®] C200 Series Chipset

Datasheet

May 2011



INFORMATION IN THIS DOCUMENT IS PROVIDED IN CONNECTION WITH INTEL PRODUCTS. NO LICENSE, EXPRESS OR IMPLIED, BY ESTOPPEL OR OTHERWISE, TO ANY INTELLECTUAL PROPERTY RIGHTS IS GRANTED BY THIS DOCUMENT. EXCEPT AS PROVIDED IN INTEL'S TERMS AND CONDITIONS OF SALE FOR SUCH PRODUCTS, INTEL ASSUMES NO LIABILITY WHATSOEVER AND INTEL DISCLAIMS ANY EXPRESS OR IMPLIED WARRANTY, RELATING TO SALE AND/OR USE OF INTEL PRODUCTS INCLUDING LIABILITY OR WARRANTIES RELATING TO FITNESS FOR A PARTICULAR PURPOSE, MERCHANTABILITY, OR INFRINGEMENT OF ANY PATENT, COPYRIGHT OR OTHER INTELLECTUAL PROPERTY RIGHT.

UNLESS OTHERWISE AGREED IN WRITING BY INTEL, THE INTEL PRODUCTS ARE NOT DESIGNED NOR INTENDED FOR ANY APPLICATION IN WHICH THE FAILURE OF THE INTEL PRODUCT COULD CREATE A SITUATION WHERE PERSONAL INJURY OR DEATH MAY OCCUR.

Intel may make changes to specifications and product descriptions at any time, without notice. Designers must not rely on the absence or characteristics of any features or instructions marked "reserved" or "undefined." Intel reserves these for future definition and shall have no responsibility whatsoever for conflicts or incompatibilities arising from future changes to them. The information here is subject to change without notice. Do not finalize a design with this information.

The products described in this document may contain design defects or errors known as errata which may cause the product to deviate from published specifications. Current characterized errata are available on request.

Contact your local Intel sales office or your distributor to obtain the latest specifications and before placing your product order.

I²C is a two-wire communications bus/protocol developed by Philips. SMBus is a subset of the I²C bus/protocol and was developed by Intel. Implementations of the I²C bus/protocol may require licenses from various entities, including Philips Electronics N.V. and North American Philips Corporation.

Intel[®] Anti-Theft Technology: No system can provide absolute security under all conditions. Requires an enabled chipset, BIOS, firmware and software and a subscription with a capable Service Provider. Consult your system manufacturer and Service Provider for availability and functionality. Intel assumes no liability for lost or stolen data and/or systems or any other damages resulting thereof. For more information, visit <http://www.intel.com/go/anti-theft>

Intel[®] High Definition Audio: Requires an Intel[®] HD Audio enabled system. Consult your PC manufacturer for more information. Sound quality will depend on equipment and actual implementation. For more information about Intel[®] HD Audio, refer to <http://www.intel.com/design/chipsets/hdaudio.htm>

Intel[®] vPro™ Technology is sophisticated and requires setup and activation. Availability of features and results will depend upon the setup and configuration of your hardware, software and IT environment. To learn more visit: <http://www.intel.com/technology/vpro>

Intel[®] Active Management Technology (Intel[®] AMT) requires activation and a system with a corporate network connection, an Intel[®] AMT-enabled chipset, network hardware and software. For notebooks, Intel AMT may be unavailable or limited over a host OS-based VPN, when connecting wirelessly, on battery power, sleeping, hibernating or powered off. Results dependent upon hardware, setup & configuration. For more information, visit <http://www.intel.com/technology/platform-technology/intel-amt>

Intel[®] Trusted Execution Technology: No computer system can provide absolute security under all conditions. Intel[®] Trusted Execution Technology (Intel[®] TXT) requires a computer system with Intel[®] Virtualization Technology, an Intel TXT-enabled processor, chipset, BIOS, Authenticated Code Modules and an Intel TXT-compatible measured launched environment (MLE). The MLE could consist of a virtual machine monitor, an OS or an application. In addition, Intel TXT requires the system to contain a TPM v1.2, as defined by the Trusted Computing Group and specific software for some uses. For more information, see <http://www.intel.com/technology/security>

Intel[®] Virtualization Technology requires a computer system with an enabled Intel[®] processor, BIOS, virtual machine monitor (VMM). Functionality, performance or other benefits will vary depending on hardware and software configurations. Software applications may not be compatible with all operating systems. Consult your PC manufacturer. For more information, visit <http://www.intel.com/go/virtualization>

Intel, Intel vPro and the Intel logo are trademarks of Intel Corporation in the U.S. and other countries.

*Other names and brands may be claimed as the property of others.

Copyright © 2011, Intel Corporation

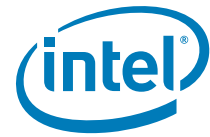

Contents

1	Introduction	41
1.1	About This Manual	41
1.2	Overview	44
1.2.1	Capability Overview	45
1.3	Intel® 6 Series Chipset and Intel® C200 Series Chipset SKU Definition	51
2	Signal Description	55
2.1	Direct Media Interface (DMI) to Host Controller	57
2.2	PCI Express*	57
2.3	PCI Interface	58
2.4	Serial ATA Interface	60
2.5	LPC Interface	63
2.6	Interrupt Interface	63
2.7	USB Interface	64
2.8	Power Management Interface	65
2.9	Processor Interface	69
2.10	SMBus Interface	69
2.11	System Management Interface	69
2.12	Real Time Clock Interface	70
2.13	Miscellaneous Signals	70
2.14	Intel® High Definition Audio Link	72
2.15	Controller Link	73
2.16	Serial Peripheral Interface (SPI)	73
2.17	Thermal Signals	73
2.18	Testability Signals	74
2.19	Clock Signals	74
2.20	LVDS Signals	77
2.21	Analog Display /VGA DAC Signals	78
2.22	Intel® Flexible Display Interface (Intel® FDI)	78
2.23	Digital Display Signals	79
2.24	General Purpose I/O Signals	82
2.25	Manageability Signals	86
2.26	Power and Ground Signals	87
2.27	Pin Straps	89
2.28	External RTC Circuitry	92
3	PCH in Platforms	93
3.1	Integrated Pull-Ups and Pull-Downs	93
3.2	Output and I/O Signals Planes and States	95
3.3	Power Planes for Input Signals	107
4	PCH and System Clocks	113
4.1	Platform Clocking Requirements	113
4.2	Functional Blocks	116
4.3	Clock Configuration Access Overview	117
4.4	Straps Related to Clock Configuration	117
5	Functional Description	119
5.1	DMI-to-PCI Bridge (D30:F0)	119
5.1.1	PCI Bus Interface	119
5.1.2	PCI Bridge As an Initiator	120
5.1.2.1	Memory Reads and Writes	120
5.1.2.2	I/O Reads and Writes	120
5.1.2.3	Configuration Reads and Writes	120
5.1.2.4	Locked Cycles	120
5.1.2.5	Target / Master Aborts	120
5.1.2.6	Secondary Master Latency Timer	120
5.1.2.7	Dual Address Cycle (DAC)	121
5.1.2.8	Memory and I/O Decode to PCI	121
5.1.3	Parity Error Detection and Generation	121
5.1.4	PCIRST#	122
5.1.5	Peer Cycles	122



5.1.6	PCI-to-PCI Bridge Model	122
5.1.7	IDSEL to Device Number Mapping	123
5.1.8	Standard PCI Bus Configuration Mechanism	123
5.1.9	PCI Legacy Mode	123
5.2	PCI Express* Root Ports (D28:F0,F1,F2,F3,F4,F5, F6, F7)	124
5.2.1	Interrupt Generation	124
5.2.2	Power Management	125
5.2.2.1	S3/S4/S5 Support	125
5.2.2.2	Resuming from Suspended State	125
5.2.2.3	Device Initiated PM_PME Message	125
5.2.2.4	SMI/SCI Generation	126
5.2.3	SERR# Generation	126
5.2.4	Hot-Plug	126
5.2.4.1	Presence Detection	126
5.2.4.2	Message Generation	127
5.2.4.3	Attention Button Detection	127
5.2.4.4	SMI/SCI Generation	127
5.3	Gigabit Ethernet Controller (B0:D25:F0)	128
5.3.1	GbE PCI Express* Bus Interface	130
5.3.1.1	Transaction Layer	130
5.3.1.2	Data Alignment	130
5.3.1.3	Configuration Request Retry Status	130
5.3.2	Error Events and Error Reporting	131
5.3.2.1	Data Parity Error	131
5.3.2.2	Completion with Unsuccessful Completion Status	131
5.3.3	Ethernet Interface	131
5.3.3.1	82579 LAN PHY Interface	131
5.3.4	PCI Power Management	132
5.3.4.1	Wake Up	132
5.3.5	Configurable LEDs	134
5.3.6	Function Level Reset Support (FLR)	135
5.3.6.1	FLR Steps	135
5.4	LPC Bridge (with System and Management Functions) (D31:F0)	136
5.4.1	LPC Interface	136
5.4.1.1	LPC Cycle Types	137
5.4.1.2	Start Field Definition	137
5.4.1.3	Cycle Type / Direction (CYCTYPE + DIR)	138
5.4.1.4	Size	138
5.4.1.5	SYNC	138
5.4.1.6	SYNC Time-Out	139
5.4.1.7	SYNC Error Indication	139
5.4.1.8	LFRAME# Usage	139
5.4.1.9	I/O Cycles	139
5.4.1.10	Bus Master Cycles	140
5.4.1.11	LPC Power Management	140
5.4.1.12	Configuration and PCH Implications	140
5.5	DMA Operation (D31:F0)	141
5.5.1	Channel Priority	141
5.5.1.1	Fixed Priority	141
5.5.1.2	Rotating Priority	142
5.5.2	Address Compatibility Mode	142
5.5.3	Summary of DMA Transfer Sizes	142
5.5.3.1	Address Shifting When Programmed for 16-Bit I/O Count by Words	142
5.5.4	Autoinitialize	143
5.5.5	Software Commands	143
5.6	LPC DMA	144
5.6.1	Asserting DMA Requests	144
5.6.2	Abandoning DMA Requests	145
5.6.3	General Flow of DMA Transfers	145
5.6.4	Terminal Count	145
5.6.5	Verify Mode	146
5.6.6	DMA Request Deassertion	146
5.6.7	SYNC Field / LDRQ# Rules	147
5.7	8254 Timers (D31:F0)	147
5.7.1	Timer Programming	148
5.7.2	Reading from the Interval Timer	149

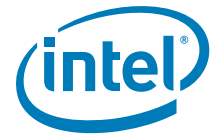

	5.7.2.1	Simple Read	149
	5.7.2.2	Counter Latch Command	149
	5.7.2.3	Read Back Command	149
5.8	8259	Interrupt Controllers (PIC) (D31:F0)	150
	5.8.1	Interrupt Handling	151
	5.8.1.1	Generating Interrupts.....	151
	5.8.1.2	Acknowledging Interrupts	151
	5.8.1.3	Hardware/Software Interrupt Sequence	152
	5.8.2	Initialization Command Words (ICWx)	152
	5.8.2.1	ICW1	152
	5.8.2.2	ICW2	153
	5.8.2.3	ICW3	153
	5.8.2.4	ICW4	153
	5.8.3	Operation Command Words (OCW)	153
	5.8.4	Modes of Operation	153
	5.8.4.1	Fully Nested Mode	153
	5.8.4.2	Special Fully-Nested Mode	154
	5.8.4.3	Automatic Rotation Mode (Equal Priority Devices)	154
	5.8.4.4	Specific Rotation Mode (Specific Priority)	154
	5.8.4.5	Poll Mode.....	154
	5.8.4.6	Cascade Mode	155
	5.8.4.7	Edge and Level Triggered Mode	155
	5.8.4.8	End of Interrupt (EOI) Operations	155
	5.8.4.9	Normal End of Interrupt	155
	5.8.4.10	Automatic End of Interrupt Mode	155
	5.8.5	Masking Interrupts	156
	5.8.5.1	Masking on an Individual Interrupt Request.....	156
	5.8.5.2	Special Mask Mode.....	156
	5.8.6	Steering PCI Interrupts.....	156
5.9	Advanced	Programmable Interrupt Controller (APIC) (D31:F0)	157
	5.9.1	Interrupt Handling	157
	5.9.2	Interrupt Mapping	157
	5.9.3	PCI / PCI Express* Message-Based Interrupts.....	158
	5.9.4	IOxAPIC Address Remapping	158
	5.9.5	External Interrupt Controller Support.....	158
5.10	Serial	Interrupt (D31:F0)	159
	5.10.1	Start Frame	159
	5.10.2	Data Frames	160
	5.10.3	Stop Frame	160
	5.10.4	Specific Interrupts Not Supported Using SERIRQ	160
	5.10.5	Data Frame Format	161
5.11	Real Time	Clock (D31:F0).....	162
	5.11.1	Update Cycles	162
	5.11.2	Interrupts	163
	5.11.3	Lockable RAM Ranges.....	163
	5.11.4	Century Rollover.....	163
	5.11.5	Clearing Battery-Backed RTC RAM.....	163
5.12	Processor	Interface (D31:F0)	165
	5.12.1	Processor Interface Signals and VLW Messages	165
	5.12.1.1	A20M# (Mask A20) / A20GATE	165
	5.12.1.2	INIT (Initialization)	166
	5.12.1.3	FERR# (Numeric Coprocessor Error).....	166
	5.12.1.4	NMI (Non-Maskable Interrupt).....	167
	5.12.1.5	Processor Power Good (PROCPWRGD)	167
	5.12.2	Dual-Processor Issues	167
	5.12.2.1	Usage Differences	167
	5.12.3	Virtual Legacy Wire (VLW) Messages	167
5.13	Power	Management	168
	5.13.1	Features	168
	5.13.2	PCH and System Power States	168
	5.13.3	System Power Planes	170
	5.13.4	SMI#/SCI Generation	171
	5.13.4.1	PCI Express* SCI.....	173
	5.13.4.2	PCI Express* Hot-Plug.....	173
	5.13.5	C-States	173
	5.13.6	Dynamic PCI Clock Control (Mobile Only)	173
	5.13.6.1	Conditions for Checking the PCI Clock	173



5.13.6.2	Conditions for Maintaining the PCI Clock.....	174
5.13.6.3	Conditions for Stopping the PCI Clock	174
5.13.6.4	Conditions for Re-Starting the PCI Clock.....	174
5.13.6.5	LPC Devices and CLKRUN#	174
5.13.7	Sleep States	174
5.13.7.1	Sleep State Overview	174
5.13.7.2	Initiating Sleep State	175
5.13.7.3	Exiting Sleep States	175
5.13.7.4	PCI Express* WAKE# Signal and PME Event Message.....	177
5.13.7.5	Sx-G3-Sx, Handling Power Failures.....	178
5.13.7.6	Deep S4/S5.....	179
5.13.8	Event Input Signals and Their Usage	180
5.13.8.1	PWRBTN# (Power Button)	180
5.13.8.2	RI# (Ring Indicator)	181
5.13.8.3	PME# (PCI Power Management Event)	181
5.13.8.4	SYS_RESET# Signal	182
5.13.8.5	THRMTRIP# Signal	182
5.13.9	ALT Access Mode.....	183
5.13.9.1	Write Only Registers with Read Paths in ALT Access Mode.....	184
5.13.9.2	PIC Reserved Bits.....	186
5.13.9.3	Read Only Registers with Write Paths in ALT Access Mode.....	186
5.13.10	System Power Supplies, Planes, and Signals	187
5.13.10.1	Power Plane Control with SLP_S3#, SLP_S4#, SLP_S5#, SLP_A# and SLP_LAN#	187
5.13.10.2	SLP_S4# and Suspend-To-RAM Sequencing	187
5.13.10.3	PWROK Signal	187
5.13.10.4	BATLOW# (Battery Low) (Mobile Only)	188
5.13.10.5	SLP_LAN# Pin Behavior	188
5.13.10.6	RTCST# and SRTCST#	188
5.13.11	Clock Generators.....	188
5.13.12	Legacy Power Management Theory of Operation	189
5.13.12.1	APM Power Management (Desktop Only)	189
5.13.12.2	Mobile APM Power Management (Mobile Only).....	189
5.13.13	Reset Behavior.....	189
5.14	System Management (D31:F0)	192
5.14.1	Theory of Operation.....	192
5.14.1.1	Detecting a System Lockup	192
5.14.1.2	Handling an Intruder	193
5.14.1.3	Detecting Improper Flash Programming	193
5.14.1.4	Heartbeat and Event Reporting using SMLink/SMBus.....	193
5.14.2	TCO Modes.....	194
5.14.2.1	TCO Legacy/Compatible Mode.....	194
5.14.2.2	Advanced TCO Mode.....	195
5.15	General Purpose I/O (D31:F0)	196
5.15.1	Power Wells.....	196
5.15.2	SMI# SCI and NMI Routing	196
5.15.3	Triggering	196
5.15.4	GPIO Registers Lockdown	196
5.15.5	Serial POST Codes over GPIO.....	197
5.15.5.1	Theory of Operation	197
5.15.5.2	Serial Message Format.....	198
5.16	SATA Host Controller (D31:F2, F5).....	199
5.16.1	SATA 6 Gb/s Support	200
5.16.2	SATA Feature Support.....	200
5.16.3	Theory of Operation.....	201
5.16.3.1	Standard ATA Emulation	201
5.16.3.2	48-Bit LBA Operation	201
5.16.4	SATA Swap Bay Support.....	201
5.16.5	Hot Plug Operation	201
5.16.5.1	Low Power Device Presence Detection	201
5.16.6	Function Level Reset Support (FLR)	202
5.16.6.1	FLR Steps	202
5.16.7	Intel® Rapid Storage Technology Configuration	202
5.16.7.1	Intel® Rapid Storage Manager RAID Option ROM	203
5.16.8	Intel® Smart Response Technology.....	203
5.16.9	Power Management Operation.....	203
5.16.9.1	Power State Mappings	203

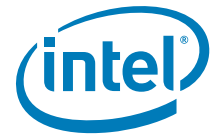

	5.16.9.2	Power State Transitions	204
	5.16.9.3	SMI Trapping (APM)	205
5.16.10		SATA Device Presence	205
5.16.11		SATA LED	206
5.16.12		AHCI Operation	206
5.16.13		SGPIO Signals	206
	5.16.13.1	Mechanism	206
	5.16.13.2	Message Format	207
	5.16.13.3	LED Message Type	208
	5.16.13.4	SGPIO Waveform	209
	5.16.14	External SATA	210
5.17		High Precision Event Timers	210
	5.17.1	Timer Accuracy	210
	5.17.2	Interrupt Mapping	211
	5.17.3	Periodic versus Non-Periodic Modes	212
	5.17.4	Enabling the Timers	212
	5.17.5	Interrupt Levels	213
	5.17.6	Handling Interrupts	213
	5.17.7	Issues Related to 64-Bit Timers with 32-Bit Processors	213
5.18		USB EHCI Host Controllers (D29:F0 and D26:F0)	214
	5.18.1	EHC Initialization	214
	5.18.1.1	BIOS Initialization	214
	5.18.1.2	Driver Initialization	214
	5.18.1.3	EHC Resets	214
	5.18.2	Data Structures in Main Memory	214
	5.18.3	USB 2.0 Enhanced Host Controller DMA	215
	5.18.4	Data Encoding and Bit Stuffing	215
	5.18.5	Packet Formats	215
	5.18.6	USB 2.0 Interrupts and Error Conditions	215
	5.18.6.1	Aborts on USB 2.0-Initiated Memory Reads	216
	5.18.7	USB 2.0 Power Management	216
	5.18.7.1	Pause Feature	216
	5.18.7.2	Suspend Feature	216
	5.18.7.3	ACPI Device States	216
	5.18.7.4	ACPI System States	217
	5.18.8	USB 2.0 Legacy Keyboard Operation	217
	5.18.9	USB 2.0 Based Debug Port	217
	5.18.9.1	Theory of Operation	218
	5.18.10	EHCI Caching	222
	5.18.11	Intel® USB Pre-Fetch Based Pause	222
	5.18.12	Function Level Reset Support (FLR)	222
	5.18.12.1	FLR Steps	222
	5.18.13	USB Overcurrent Protection	223
5.19		Integrated USB 2.0 Rate Matching Hub	224
	5.19.1	Overview	224
	5.19.2	Architecture	224
5.20		SMBus Controller (D31:F3)	225
	5.20.1	Host Controller	225
	5.20.1.1	Command Protocols	226
	5.20.2	Bus Arbitration	229
	5.20.3	Bus Timing	230
	5.20.3.1	Clock Stretching	230
	5.20.3.2	Bus Time Out (The PCH as SMBus Master)	230
	5.20.4	Interrupts / SMI#	230
	5.20.5	SMBALERT#	231
	5.20.6	SMBus CRC Generation and Checking	231
	5.20.7	SMBus Slave Interface	232
	5.20.7.1	Format of Slave Write Cycle	233
	5.20.7.2	Format of Read Command	234
	5.20.7.3	Slave Read of RTC Time Bytes	236
	5.20.7.4	Format of Host Notify Command	237
5.21		Thermal Management	238
	5.21.1	Thermal Sensor	238
	5.21.1.1	Internal Thermal Sensor Operation	238
	5.21.2	PCH Thermal Throttling	239
	5.21.3	Thermal Reporting Over System Management Link 1 Interface (SMLink1)	240
	5.21.3.1	Supported Addresses	241

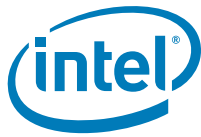

	5.21.3.2	I ² C Write Commands to the Intel® ME	242
	5.21.3.3	Block Read Command	242
	5.21.3.4	Read Data Format	244
	5.21.3.5	Thermal Data Update Rate	244
	5.21.3.6	Temperature Comparator and Alert	244
	5.21.3.7	BIOS Set Up	246
	5.21.3.8	SMBus Rules	246
	5.21.3.9	Case for Considerations	247
5.22		Intel® High Definition Audio Overview (D27:F0)	249
	5.22.1	Intel® High Definition Audio Docking (Mobile Only)	249
		5.22.1.1 Dock Sequence	249
		5.22.1.2 Exiting D3/CRST# When Docked	250
		5.22.1.3 Cold Boot/Resume from S3 When Docked	251
		5.22.1.4 Undock Sequence	251
		5.22.1.5 Normal Undock	251
		5.22.1.6 Surprise Undock	252
		5.22.1.7 Interaction between Dock/Undock and Power Management States	252
		5.22.1.8 Relationship between HDA_DOCK_RST# and HDA_RST#	252
5.23		Intel® ME and Intel® ME Firmware 7.0	253
	5.23.1	Intel® ME Requirements	254
5.24		Serial Peripheral Interface (SPI)	255
	5.24.1	SPI Supported Feature Overview	255
		5.24.1.1 Non-Descriptor Mode	255
		5.24.1.2 Descriptor Mode	255
	5.24.2	Flash Descriptor	256
		5.24.2.1 Descriptor Master Region	258
	5.24.3	Flash Access	259
		5.24.3.1 Direct Access Security	259
		5.24.3.2 Register Access Security	259
	5.24.4	Serial Flash Device Compatibility Requirements	260
		5.24.4.1 PCH SPI-Based BIOS Requirements	260
		5.24.4.2 Integrated LAN Firmware SPI Flash Requirements	260
		5.24.4.3 Intel® Management Engine Firmware SPI Flash Requirements	261
		5.24.4.4 Hardware Sequencing Requirements	261
	5.24.5	Multiple Page Write Usage Model	262
		5.24.5.1 Soft Flash Protection	263
		5.24.5.2 BIOS Range Write Protection	263
		5.24.5.3 SMI# Based Global Write Protection	263
	5.24.6	Flash Device Configurations	263
	5.24.7	SPI Flash Device Recommended Pinout	264
	5.24.8	Serial Flash Device Package	264
		5.24.8.1 Common Footprint Usage Model	264
		5.24.8.2 Serial Flash Device Package Recommendations	265
	5.24.9	PWM Outputs (Server/Workstation Only)	265
	5.24.10	TACH Inputs (Server/Workstation Only)	265
5.25		Feature Capability Mechanism	265
5.26		PCH Display Interfaces and Intel® Flexible Display Interconnect	266
	5.26.1	Analog Display Interface Characteristics	266
		5.26.1.1 Integrated RAMDAC	267
		5.26.1.2 DDC (Display Data Channel)	267
	5.26.2	Digital Display Interfaces	267
		5.26.2.1 LVDS (Mobile only)	267
		5.26.2.2 High Definition Multimedia Interface	270
		5.26.2.3 Digital Video Interface (DVI)	271
		5.26.2.4 DisplayPort*	271
		5.26.2.5 Embedded DisplayPort	272
		5.26.2.6 DisplayPort Aux Channel	272
		5.26.2.7 DisplayPort Hot-Plug Detect (HPD)	272
		5.26.2.8 Integrated Audio over HDMI and DisplayPort	272
		5.26.2.9 Serial Digital Video Out (SDVO)	272
	5.26.3	Mapping of Digital Display Interface Signals	274
	5.26.4	Multiple Display Configurations	275
	5.26.5	High-bandwidth Digital Content Protection (HDCP)	275
	5.26.6	Intel® Flexible Display Interconnect	276
5.27		Intel® Virtualization Technology	276
	5.27.1	Intel® VT-d Objectives	276

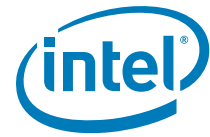

5.27.2	Intel® VT-d Features Supported.....	276
5.27.3	Support for Function Level Reset (FLR) in PCH	277
5.27.4	Virtualization Support for PCH's IOxAPIC	277
5.27.5	Virtualization Support for High Precision Event Timer (HPET)	277
6	Ballout Definition	279
6.1	Desktop PCH Ballout	279
6.2	Mobile PCH Ballout	290
6.3	Mobile SFF PCH Ballout	302
7	Package Information	307
7.1	Desktop PCH package	307
7.2	Mobile PCH Package.....	309
7.3	Mobile SFF PCH Package.....	311
8	Electrical Characteristics	313
8.1	Thermal Specifications	313
8.1.1	Desktop Storage Specifications and Thermal Design Power (TDP)	313
8.1.2	Mobile Storage Specifications and Thermal Design Power (TDP)	313
8.2	Absolute Maximum Ratings.....	314
8.3	PCH Power Supply Range	315
8.4	General DC Characteristics	315
8.5	Display DC Characteristics	328
8.6	AC Characteristics	330
8.7	Power Sequencing and Reset Signal Timings	347
8.8	Power Management Timing Diagrams.....	350
8.9	AC Timing Diagrams	355
9	Register and Memory Mapping.....	365
9.1	PCI Devices and Functions.....	366
9.2	PCI Configuration Map	367
9.3	I/O Map	367
9.3.1	Fixed I/O Address Ranges	367
9.3.2	Variable I/O Decode Ranges	370
9.4	Memory Map.....	371
9.4.1	Boot-Block Update Scheme	373
10	Chipset Configuration Registers.....	375
10.1	Chipset Configuration Registers (Memory Space)	375
10.1.1	CIR0—Chipset Initialization Register 0	377
10.1.2	RPC—Root Port Configuration Register	377
10.1.3	RPFN—Root Port Function Number and Hide for PCI Express* Root Ports Register	378
10.1.4	FLRSTAT—Function Level Reset Pending Status Register	379
10.1.5	TRSR—Trap Status Register	380
10.1.6	TRCR—Trapped Cycle Register.....	380
10.1.7	TWDR—Trapped Write Data Register	381
10.1.8	IOTRn—I/O Trap Register (0–3).....	381
10.1.9	V0CTL—Virtual Channel 0 Resource Control Register.....	382
10.1.10	V0STS—Virtual Channel 0 Resource Status Register.....	382
10.1.11	V1CTL—Virtual Channel 1 Resource Control Register.....	383
10.1.12	V1STS—Virtual Channel 1 Resource Status Register.....	383
10.1.13	REC—Root Error Command Register	384
10.1.14	LCAP—Link Capabilities Register	384
10.1.15	LCTL—Link Control Register.....	385
10.1.16	LSTS—Link Status Register	385
10.1.17	DLCTL2—DMI Link Control 2 Register	385
10.1.18	DMIC—DMI Control Register.....	386
10.1.19	TCTL—TCO Configuration Register.....	386
10.1.20	D31IP—Device 31 Interrupt Pin Register	387
10.1.21	D30IP—Device 30 Interrupt Pin Register	388
10.1.22	D29IP—Device 29 Interrupt Pin Register	388
10.1.23	D28IP—Device 28 Interrupt Pin Register	388
10.1.24	D27IP—Device 27 Interrupt Pin Register	390
10.1.25	D26IP—Device 26 Interrupt Pin Register	390
10.1.26	D25IP—Device 25 Interrupt Pin Register	390
10.1.27	D22IP—Device 22 Interrupt Pin Register	391
10.1.28	D31IR—Device 31 Interrupt Route Register	392



10.1.29	D29IR—Device 29 Interrupt Route Register.....	393
10.1.30	D28IR—Device 28 Interrupt Route Register.....	394
10.1.31	D27IR—Device 27 Interrupt Route Register.....	395
10.1.32	D26IR—Device 26 Interrupt Route Register.....	396
10.1.33	D25IR—Device 25 Interrupt Route Register.....	397
10.1.34	D22IR—Device 22 Interrupt Route Register.....	398
10.1.35	OIC—Other Interrupt Control Register.....	399
10.1.36	PRSTS—Power and Reset Status Register.....	400
10.1.37	PM_CFG—Power Management Configuration Register.....	401
10.1.38	DEEP_S4_POL—Deep S4/S5 From S4 Power Policies Register.....	402
10.1.39	DEEP_S5_POL—Deep S4/S5 From S5 Power Policies Register.....	402
10.1.40	PMSYNC_CFG—PMSYNC Configuration Register.....	403
10.1.41	RC—RTC Configuration Register.....	404
10.1.42	HPTC—High Precision Timer Configuration Register.....	404
10.1.43	GCS—General Control and Status Register.....	405
10.1.44	BUC—Backed Up Control Register.....	407
10.1.45	FD—Function Disable Register.....	407
10.1.46	CG—Clock Gating Register.....	409
10.1.47	FDSW—Function Disable SUS Well Register.....	410
10.1.48	DISPBDF—Display Bus, Device and Function Initialization Register.....	411
10.1.49	FD2—Function Disable 2 Register.....	411
10.1.50	MISCCTL—Miscellaneous Control Register.....	412
10.1.51	USBOCM1—Overcurrent MAP Register 1.....	413
10.1.52	USBOCM2—Overcurrent MAP Register 2.....	414
10.1.53	RMHWKCTL—Rate Matching Hub Wake Control Register.....	415
11	PCI-to-PCI Bridge Registers (D30:F0).....	417
11.1	PCI Configuration Registers (D30:F0).....	417
11.1.1	VID—Vendor Identification Register (PCI-PCI—D30:F0).....	418
11.1.2	DID—Device Identification Register (PCI-PCI—D30:F0).....	418
11.1.3	PCICMD—PCI Command (PCI-PCI—D30:F0).....	418
11.1.4	PSTS—PCI Status Register (PCI-PCI—D30:F0).....	419
11.1.5	RID—Revision Identification Register (PCI-PCI—D30:F0).....	421
11.1.6	CC—Class Code Register (PCI-PCI—D30:F0).....	421
11.1.7	PMLT—Primary Master Latency Timer Register (PCI-PCI—D30:F0).....	422
11.1.8	HEADTYP—Header Type Register (PCI-PCI—D30:F0).....	422
11.1.9	BNUM—Bus Number Register (PCI-PCI—D30:F0).....	422
11.1.10	SMLT—Secondary Master Latency Timer Register (PCI-PCI—D30:F0).....	423
11.1.11	IOBASE_LIMIT—I/O Base and Limit Register (PCI-PCI—D30:F0).....	423
11.1.12	SECSTS—Secondary Status Register (PCI-PCI—D30:F0).....	424
11.1.13	MEMBASE_LIMIT—Memory Base and Limit Register (PCI-PCI—D30:F0).....	425
11.1.14	PREF_MEM_BASE_LIMIT—Prefetchable Memory Base and Limit Register (PCI-PCI—D30:F0).....	425
11.1.15	PMBU32—Prefetchable Memory Base Upper 32 Bits Register (PCI-PCI—D30:F0).....	426
11.1.16	PMLU32—Prefetchable Memory Limit Upper 32 Bits Register (PCI-PCI—D30:F0).....	426
11.1.17	CAPP—Capability List Pointer Register (PCI-PCI—D30:F0).....	426
11.1.18	INTR—Interrupt Information Register (PCI-PCI—D30:F0).....	426
11.1.19	BCTRL—Bridge Control Register (PCI-PCI—D30:F0).....	427
11.1.20	SPDH—Secondary PCI Device Hiding Register (PCI-PCI—D30:F0).....	428
11.1.21	DTC—Delayed Transaction Control Register (PCI-PCI—D30:F0).....	429
11.1.22	BPS—Bridge Proprietary Status Register (PCI-PCI—D30:F0).....	430
11.1.23	BPC—Bridge Policy Configuration Register (PCI-PCI—D30:F0).....	431
11.1.24	SVCAP—Subsystem Vendor Capability Register (PCI-PCI—D30:F0).....	432

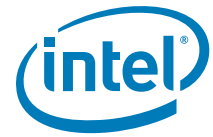

11.1.25	SVID—Subsystem Vendor IDs Register (PCI-PCI—D30:F0)	433
12	Gigabit LAN Configuration Registers	435
12.1	Gigabit LAN Configuration Registers (Gigabit LAN — D25:F0)	435
12.1.1	VID—Vendor Identification Register (Gigabit LAN—D25:F0)	436
12.1.2	DID—Device Identification Register (Gigabit LAN—D25:F0)	436
12.1.3	PCICMD—PCI Command Register (Gigabit LAN—D25:F0)	437
12.1.4	PCISTS—PCI Status Register (Gigabit LAN—D25:F0)	438
12.1.5	RID—Revision Identification Register (Gigabit LAN—D25:F0)	439
12.1.6	CC—Class Code Register (Gigabit LAN—D25:F0)	439
12.1.7	CLS—Cache Line Size Register (Gigabit LAN—D25:F0)	439
12.1.8	PLT—Primary Latency Timer Register (Gigabit LAN—D25:F0)	439
12.1.9	HEADTYP—Header Type Register (Gigabit LAN—D25:F0)	439
12.1.10	MBARA—Memory Base Address Register A (Gigabit LAN—D25:F0)	440
12.1.11	MBARB—Memory Base Address Register B (Gigabit LAN—D25:F0)	440
12.1.12	MBARC—Memory Base Address Register C (Gigabit LAN—D25:F0)	441
12.1.13	SVID—Subsystem Vendor ID Register (Gigabit LAN—D25:F0)	441
12.1.14	SID—Subsystem ID Register (Gigabit LAN—D25:F0)	441
12.1.15	ERBA—Expansion ROM Base Address Register (Gigabit LAN—D25:F0)	441
12.1.16	CAPP—Capabilities List Pointer Register (Gigabit LAN—D25:F0)	442
12.1.17	INTR—Interrupt Information Register (Gigabit LAN—D25:F0)	442
12.1.18	MLMG—Maximum Latency/Minimum Grant Register (Gigabit LAN—D25:F0)	442
12.1.19	CLIST1—Capabilities List Register 1 (Gigabit LAN—D25:F0)	442
12.1.20	PMC—PCI Power Management Capabilities Register (Gigabit LAN—D25:F0)	443
12.1.21	PMCS—PCI Power Management Control and Status Register (Gigabit LAN—D25:F0)	444
12.1.22	DR—Data Register (Gigabit LAN—D25:F0)	445
12.1.23	CLIST2—Capabilities List Register 2 (Gigabit LAN—D25:F0)	445
12.1.24	MCTL—Message Control Register (Gigabit LAN—D25:F0)	445
12.1.25	MADDL—Message Address Low Register (Gigabit LAN—D25:F0)	446
12.1.26	MADDH—Message Address High Register (Gigabit LAN—D25:F0)	446
12.1.27	MDAT—Message Data Register (Gigabit LAN—D25:F0)	446
12.1.28	FLRCAP—Function Level Reset Capability (Gigabit LAN—D25:F0)	446
12.1.29	FLRCLV—Function Level Reset Capability Length and Version Register (Gigabit LAN—D25:F0)	447
12.1.30	DEVCTRL—Device Control Register (Gigabit LAN—D25:F0)	447



13	LPC Interface Bridge Registers (D31:F0)	449
13.1	PCI Configuration Registers (LPC I/F—D31:F0)	449
13.1.1	VID—Vendor Identification Register (LPC I/F—D31:F0)	450
13.1.2	DID—Device Identification Register (LPC I/F—D31:F0)	450
13.1.3	PCICMD—PCI COMMAND Register (LPC I/F—D31:F0)	451
13.1.4	PCISTS—PCI Status Register (LPC I/F—D31:F0)	451
13.1.5	RID—Revision Identification Register (LPC I/F—D31:F0)	452
13.1.6	PI—Programming Interface Register (LPC I/F—D31:F0)	452
13.1.7	SCC—Sub Class Code Register (LPC I/F—D31:F0)	453
13.1.8	BCC—Base Class Code Register (LPC I/F—D31:F0)	453
13.1.9	PLT—Primary Latency Timer Register (LPC I/F—D31:F0)	453
13.1.10	HEADTYP—Header Type Register (LPC I/F—D31:F0)	453
13.1.11	SS—Sub System Identifiers Register (LPC I/F—D31:F0)	454
13.1.12	PMBASE—ACPI Base Address Register (LPC I/F—D31:F0)	454
13.1.13	ACPI_CNTL—ACPI Control Register (LPC I/F—D31:F0)	455
13.1.14	GPIOBASE—GPIO Base Address Register (LPC I/F—D31:F0)	455
13.1.15	GC—GPIO Control Register (LPC I/F—D31:F0)	456
13.1.16	PIRQ[n]_ROUT—PIRQ[A,B,C,D] Routing Control Register (LPC I/F—D31:F0)	457
13.1.17	SIRQ_CNTL—Serial IRQ Control Register (LPC I/F—D31:F0)	458
13.1.18	PIRQ[n]_ROUT—PIRQ[E,F,G,H] Routing Control Register (LPC I/F—D31:F0)	459
13.1.19	LPC_IBDF—IOxAPIC Bus:Device:Function (LPC I/F—D31:F0)	459
13.1.20	LPC_HnBDF—HPET n Bus:Device:Function (LPC I/F—D31:F0)	460
13.1.21	LPC_I/O_DEC—I/O Decode Ranges Register (LPC I/F—D31:F0)	461
13.1.22	LPC_EN—LPC I/F Enables Register (LPC I/F—D31:F0)	462
13.1.23	GEN1_DEC—LPC I/F Generic Decode Range 1 Register (LPC I/F—D31:F0)	463
13.1.24	GEN2_DEC—LPC I/F Generic Decode Range 2 Register (LPC I/F—D31:F0)	463
13.1.25	GEN3_DEC—LPC I/F Generic Decode Range 3 Register (LPC I/F—D31:F0)	464
13.1.26	GEN4_DEC—LPC I/F Generic Decode Range 4 Register (LPC I/F—D31:F0)	464
13.1.27	ULKMC — USB Legacy Keyboard / Mouse Control Register (LPC I/F—D31:F0)	465
13.1.28	LGMR — LPC I/F Generic Memory Range Register (LPC I/F—D31:F0)	466
13.1.29	BIOS_SEL1—BIOS Select 1 Register (LPC I/F—D31:F0)	467
13.1.30	BIOS_SEL2—BIOS Select 2 Register (LPC I/F—D31:F0)	468
13.1.31	BIOS_DEC_EN1—BIOS Decode Enable Register (LPC I/F—D31:F0)	469
13.1.32	BIOS_CNTL—BIOS Control Register (LPC I/F—D31:F0)	471
13.1.33	FDCAP—Feature Detection Capability ID Register (LPC I/F—D31:F0)	472
13.1.34	FDLEN—Feature Detection Capability Length Register (LPC I/F—D31:F0)	472
13.1.35	FDVER—Feature Detection Version Register (LPC I/F—D31:F0)	472
13.1.36	FVECIDX—Feature Vector Index Register (LPC I/F—D31:F0)	472
13.1.37	FVECD—Feature Vector Data Register (LPC I/F—D31:F0)	473
13.1.38	Feature Vector Space	473
13.1.38.1	FVEC0—Feature Vector Register 0	473
13.1.38.2	FVEC1—Feature Vector Register 1	474
13.1.38.3	FVEC2—Feature Vector Register 2	474
13.1.38.4	FVEC3—Feature Vector Register 3	475
13.1.39	RCBA—Root Complex Base Address Register (LPC I/F—D31:F0)	475

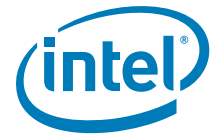

13.2	DMA I/O Registers.....	476
13.2.1	DMABASE_CA—DMA Base and Current Address Registers.....	477
13.2.2	DMABASE_CC—DMA Base and Current Count Registers.....	478
13.2.3	DMAMEM_LP—DMA Memory Low Page Registers.....	478
13.2.4	DMACMD—DMA Command Register.....	479
13.2.5	DMASTA—DMA Status Register.....	479
13.2.6	DMA_WRSMSK—DMA Write Single Mask Register.....	480
13.2.7	DMACH_MODE—DMA Channel Mode Register.....	480
13.2.8	DMA Clear Byte Pointer Register.....	481
13.2.9	DMA Master Clear Register.....	481
13.2.10	DMA_CLMSK—DMA Clear Mask Register.....	481
13.2.11	DMA_WRMSK—DMA Write All Mask Register.....	482
13.3	Timer I/O Registers.....	482
13.3.1	TCW—Timer Control Word Register.....	483
13.3.2	SBYTE_FMT—Interval Timer Status Byte Format Register.....	485
13.3.3	Counter Access Ports Register.....	486
13.4	8259 Interrupt Controller (PIC) Registers.....	486
13.4.1	Interrupt Controller I/O MAP.....	486
13.4.2	ICW1—Initialization Command Word 1 Register.....	487
13.4.3	ICW2—Initialization Command Word 2 Register.....	488
13.4.4	ICW3—Master Controller Initialization Command Word 3 Register.....	488
13.4.5	ICW3—Slave Controller Initialization Command Word 3 Register.....	489
13.4.6	ICW4—Initialization Command Word 4 Register.....	489
13.4.7	OCW1—Operational Control Word 1 (Interrupt Mask) Register.....	490
13.4.8	OCW2—Operational Control Word 2 Register.....	490
13.4.9	OCW3—Operational Control Word 3 Register.....	491
13.4.10	ELCR1—Master Controller Edge/Level Triggered Register.....	492
13.4.11	ELCR2—Slave Controller Edge/Level Triggered Register.....	493
13.5	Advanced Programmable Interrupt Controller (APIC).....	494
13.5.1	APIC Register Map.....	494
13.5.2	IND—Index Register.....	494
13.5.3	DAT—Data Register.....	495
13.5.4	EOIR—EOI Register.....	495
13.5.5	ID—Identification Register.....	496
13.5.6	VER—Version Register.....	496
13.5.7	REDIR_TBL—Redirection Table Register.....	497
13.6	Real Time Clock Registers.....	499
13.6.1	I/O Register Address Map.....	499
13.6.2	Indexed Registers.....	500
13.6.2.1	RTC_REGA—Register A.....	501
13.6.2.2	RTC_REGB—Register B (General Configuration).....	502
13.6.2.3	RTC_REGC—Register C (Flag Register).....	503
13.6.2.4	RTC_REGD—Register D (Flag Register).....	503
13.7	Processor Interface Registers.....	504
13.7.1	NMI_SC—NMI Status and Control Register.....	504
13.7.2	NMI_EN—NMI Enable (and Real Time Clock Index) Register.....	505
13.7.3	PORT92—Fast A20 and Init Register.....	505
13.7.4	COPROC_ERR—Coprocessor Error Register.....	505
13.7.5	RST_CNT—Reset Control Register.....	506
13.8	Power Management Registers.....	507
13.8.1	Power Management PCI Configuration Registers (PM—D31:F0).....	507
13.8.1.1	GEN_PMCON_1—General PM Configuration 1 Register (PM—D31:F0).....	508
13.8.1.2	GEN_PMCON_2—General PM Configuration 2 Register (PM—D31:F0).....	509
13.8.1.3	GEN_PMCON_3—General PM Configuration 3 Register (PM—D31:F0).....	510
13.8.1.4	GEN_PMCON_LOCK—General Power Management Configuration Lock Register.....	514
13.8.1.5	CIR4—Chipset Initialization Register 4 (PM—D31:F0).....	514
13.8.1.6	BM_BREAK_EN_2 Register #2 (PM—D31:F0).....	514
13.8.1.7	BM_BREAK_EN Register (PM—D31:F0).....	515



	13.8.1.8	PMIR—Power Management Initialization Register (PM—D31:F0)	516
	13.8.1.9	GPIO_ROUT—GPIO Routing Control Register (PM—D31:F0)	516
13.8.2		APM I/O Decode Register	517
	13.8.2.1	APM_CNT—Advanced Power Management Control Port Register	517
	13.8.2.2	APM_STS—Advanced Power Management Status Port Register	517
13.8.3		Power Management I/O Registers	518
	13.8.3.1	PM1_STS—Power Management 1 Status Register	519
	13.8.3.2	PM1_EN—Power Management 1 Enable Register	521
	13.8.3.3	PM1_CNT—Power Management 1 Control Register	522
	13.8.3.4	PM1_TMR—Power Management 1 Timer Register	523
	13.8.3.5	GPE0_STS—General Purpose Event 0 Status Register	524
	13.8.3.6	GPE0_EN—General Purpose Event 0 Enables Register	527
	13.8.3.7	SMI_EN—SMI Control and Enable Register	529
	13.8.3.8	SMI_STS—SMI Status Register	531
	13.8.3.9	ALT_GP_SMI_EN—Alternate GPI SMI Enable Register	533
	13.8.3.10	ALT_GP_SMI_STS—Alternate GPI SMI Status Register	534
	13.8.3.11	GPE_CNTL—General Purpose Control Register	534
	13.8.3.12	DEVACT_STS — Device Activity Status Register	535
	13.8.3.13	PM2_CNT—Power Management 2 Control Register	535
13.9		System Management TCO Registers	536
	13.9.1	TCO_RLD—TCO Timer Reload and Current Value Register	536
	13.9.2	TCO_DAT_IN—TCO Data In Register	537
	13.9.3	TCO_DAT_OUT—TCO Data Out Register	537
	13.9.4	TCO1_STS—TCO1 Status Register	537
	13.9.5	TCO2_STS—TCO2 Status Register	539
	13.9.6	TCO1_CNT—TCO1 Control Register	540
	13.9.7	TCO2_CNT—TCO2 Control Register	541
	13.9.8	TCO_MESSAGE1 and TCO_MESSAGE2 Registers	541
	13.9.9	TCO_WDCNT—TCO Watchdog Control Register	542
	13.9.10	SW_IRQ_GEN—Software IRQ Generation Register	542
	13.9.11	TCO_TMR—TCO Timer Initial Value Register	542
13.10		General Purpose I/O Registers	543
	13.10.1	GPIO_USE_SEL—GPIO Use Select Register	544
	13.10.2	GP_IO_SEL—GPIO Input/Output Select Register	544
	13.10.3	GP_LVL—GPIO Level for Input or Output Register	545
	13.10.4	GPO_BLINK—GPO Blink Enable Register	545
	13.10.5	GP_SER_BLINK—GP Serial Blink Register	546
	13.10.6	GP_SB_CMDSTS—GP Serial Blink Command Status Register	546
	13.10.7	GP_SB_DATA—GP Serial Blink Data Register	547
	13.10.8	GPI_NMI_EN—GPI NMI Enable Register	547
	13.10.9	GPI_NMI_STS—GPI NMI Status Register	547
	13.10.10	GPI_INV—GPIO Signal Invert Register	548
	13.10.11	GPIO_USE_SEL2—GPIO Use Select 2 Register	548
	13.10.12	GP_IO_SEL2—GPIO Input/Output Select 2 Register	549
	13.10.13	GP_LVL2—GPIO Level for Input or Output 2 Register	549
	13.10.14	GPIO_USE_SEL3—GPIO Use Select 3 Register	550
	13.10.15	GPIO_SEL3—GPIO Input/Output Select 3 Register	550
	13.10.16	GP_LVL3—GPIO Level for Input or Output 3 Register	551
	13.10.17	GP_RST_SEL1—GPIO Reset Select Register	551
	13.10.18	GP_RST_SEL2—GPIO Reset Select Register	552
	13.10.19	GP_RST_SEL3—GPIO Reset Select Register	552
14		SATA Controller Registers (D31:F2)	553
14.1		PCI Configuration Registers (SATA—D31:F2)	553
	14.1.1	VID—Vendor Identification Register (SATA—D31:F2)	555
	14.1.2	DID—Device Identification Register (SATA—D31:F2)	555
	14.1.3	PCICMD—PCI Command Register (SATA—D31:F2)	555
	14.1.4	PCISTS — PCI Status Register (SATA—D31:F2)	556
	14.1.5	RID—Revision Identification Register (SATA—D31:F2)	557
	14.1.6	PI—Programming Interface Register (SATA—D31:F2)	557
	14.1.6.1	When Sub Class Code Register (D31:F2:Offset 0Ah) = 01h	557
	14.1.6.2	When Sub Class Code Register (D31:F2:Offset 0Ah) = 04h	557
	14.1.6.3	When Sub Class Code Register (D31:F2:Offset 0Ah) = 06h	558

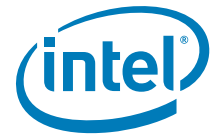

14.1.7	SCC—Sub Class Code Register (SATA-D31:F2)	558
14.1.8	BCC—Base Class Code Register (SATA-D31:F2SATA-D31:F2)	558
14.1.9	PMLT—Primary Master Latency Timer Register (SATA-D31:F2)	559
14.1.10	HTYPE—Header Type Register (SATA-D31:F2)	559
14.1.11	PCMD_BAR—Primary Command Block Base Address Register (SATA-D31:F2)	559
14.1.12	PCNL_BAR—Primary Control Block Base Address Register (SATA-D31:F2)	560
14.1.13	SCMD_BAR—Secondary Command Block Base Address Register (SATA D31:F2).....	560
14.1.14	SCNL_BAR—Secondary Control Block Base Address Register (SATA D31:F2).....	560
14.1.15	BAR—Legacy Bus Master Base Address Register (SATA-D31:F2)	561
14.1.16	ABAR/SIDPBA1—AHCI Base Address Register/Serial ATA Index Data Pair Base Address (SATA-D31:F2)	561
	14.1.16.1 When SCC is not 01h	561
	14.1.16.2 When SCC is 01h.....	562
14.1.17	SVID—Subsystem Vendor Identification Register (SATA-D31:F2)	562
14.1.18	SID—Subsystem Identification Register (SATA-D31:F2).....	562
14.1.19	CAP—Capabilities Pointer Register (SATA-D31:F2)	562
14.1.20	INT_LN—Interrupt Line Register (SATA-D31:F2)	563
14.1.21	INT_PN—Interrupt Pin Register (SATA-D31:F2)	563
14.1.22	IDE_TIM—IDE Timing Register (SATA-D31:F2).....	563
14.1.23	PID—PCI Power Management Capability Identification Register (SATA-D31:F2)	563
14.1.24	PC—PCI Power Management Capabilities Register (SATA-D31:F2)	564
14.1.25	PMCS—PCI Power Management Control and Status Register (SATA-D31:F2)	565
14.1.26	MSICI—Message Signaled Interrupt Capability Identification Register (SATA-D31:F2)	566
14.1.27	MSIMC—Message Signaled Interrupt Message Control Register (SATA-D31:F2)	566
14.1.28	MSIMA— Message Signaled Interrupt Message Address Register (SATA-D31:F2)	568
14.1.29	MSIMD—Message Signaled Interrupt Message Data Register (SATA-D31:F2)	568
14.1.30	MAP—Address Map Register (SATA-D31:F2).....	569
14.1.31	PCS—Port Control and Status Register (SATA-D31:F2)	570
14.1.32	SCLKCG—SATA Clock Gating Control Register.....	572
14.1.33	SCLKGC—SATA Clock General Configuration Register.....	572
14.1.34	SATACR0—SATA Capability Register 0 (SATA-D31:F2).....	573
14.1.35	SATACR1—SATA Capability Register 1 (SATA-D31:F2).....	574
14.1.36	FLRCID—FLR Capability ID Register (SATA-D31:F2)	574
14.1.37	FLRCLV—FLR Capability Length and Version Register (SATA-D31:F2)	575
14.1.38	FLRC—FLR Control Register (SATA-D31:F2)	575
14.1.39	ATC—APM Trapping Control Register (SATA-D31:F2).....	576
14.1.40	ATS—APM Trapping Status Register (SATA-D31:F2)	576
14.1.41	SP Scratch Pad Register (SATA-D31:F2)	576
14.1.42	BFCS—BIST FIS Control/Status Register (SATA-D31:F2).....	577
14.1.43	BFTD1—BIST FIS Transmit Data1 Register (SATA-D31:F2).....	579
14.1.44	BFTD2—BIST FIS Transmit Data2 Register (SATA-D31:F2).....	579
14.2	Bus Master IDE I/O Registers (D31:F2)	580
14.2.1	BMIC[P,S]—Bus Master IDE Command Register (D31:F2).....	581
14.2.2	BMIS[P,S]—Bus Master IDE Status Register (D31:F2).....	582
14.2.3	BMID[P,S]—Bus Master IDE Descriptor Table Pointer Register (D31:F2)	583
14.2.4	AIR—AHCI Index Register (D31:F2)	583
14.2.5	AIDR—AHCI Index Data Register (D31:F2).....	583
14.3	Serial ATA Index/Data Pair Superset Registers	584
14.3.1	SINDX—Serial ATA Index Register (D31:F2)	584

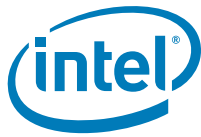

14.3.2	SDATA—Serial ATA Data Register (D31:F2).....	585
14.3.2.1	PxSSTS—Serial ATA Status Register (D31:F2).....	585
14.3.2.2	PxSCTL—Serial ATA Control Register (D31:F2).....	586
14.3.2.3	PxSERR—Serial ATA Error Register (D31:F2).....	587
14.4	AHCI Registers (D31:F2)	588
14.4.1	AHCI Generic Host Control Registers (D31:F2)	589
14.4.1.1	CAP—Host Capabilities Register (D31:F2).....	590
14.4.1.2	GHC—Global PCH Control Register (D31:F2)	592
14.4.1.3	IS—Interrupt Status Register (D31:F2).....	593
14.4.1.4	PI—Ports Implemented Register (D31:F2)	594
14.4.1.5	VS—AHCI Version Register (D31:F2)	595
14.4.1.6	EM_LOC—Enclosure Management Location Register (D31:F2) ..	595
14.4.1.7	EM_CTRL—Enclosure Management Control Register (D31:F2) ..	596
14.4.1.8	CAP2—HBA Capabilities Extended Register	597
14.4.1.9	VSP—Vendor Specific Register (D31:F2).....	597
14.4.1.10	RSTF—Intel® RST Feature Capabilities Register.....	598
14.4.2	Port Registers (D31:F2)	599
14.4.2.1	PxCLB—Port [5:0] Command List Base Address Register (D31:F2)	602
14.4.2.2	PxCLBU—Port [5:0] Command List Base Address Upper 32-Bits Register (D31:F2)	602
14.4.2.3	PxFB—Port [5:0] FIS Base Address Register (D31:F2).....	602
14.4.2.4	PxFBU—Port [5:0] FIS Base Address Upper 32-Bits Register (D31:F2)	603
14.4.2.5	PxIS—Port [5:0] Interrupt Status Register (D31:F2).....	603
14.4.2.6	PxIE—Port [5:0] Interrupt Enable Register (D31:F2).....	605
14.4.2.7	PxCMD—Port [5:0] Command Register (D31:F2).....	606
14.4.2.8	PxTFD—Port [5:0] Task File Data Register (D31:F2)	609
14.4.2.9	PxSIG—Port [5:0] Signature Register (D31:F2).....	609
14.4.2.10	PxSSTS—Port [5:0] Serial ATA Status Register (D31:F2).....	610
14.4.2.11	PxSCTL — Port [5:0] Serial ATA Control Register (D31:F2)	611
14.4.2.12	PxSERR—Port [5:0] Serial ATA Error Register (D31:F2).....	612
14.4.2.13	PxSACT—Port [5:0] Serial ATA Active Register (D31:F2)	614
14.4.2.14	PxCI—Port [5:0] Command Issue Register (D31:F2).....	614
15	SATA Controller Registers (D31:F5)	615
15.1	PCI Configuration Registers (SATA-D31:F5)	615
15.1.1	VID—Vendor Identification Register (SATA-D31:F5).....	616
15.1.2	DID—Device Identification Register (SATA-D31:F5).....	616
15.1.3	PCICMD—PCI Command Register (SATA-D31:F5).....	617
15.1.4	PCISTS — PCI Status Register (SATA-D31:F5).....	618
15.1.5	RID—Revision Identification Register (SATA-D31:F5).....	618
15.1.6	PI—Programming Interface Register (SATA-D31:F5).....	619
15.1.7	SCC—Sub Class Code Register (SATA-D31:F5).....	619
15.1.8	BCC—Base Class Code Register (SATA-D31:F5SATA-D31:F5)	619
15.1.9	PMLT—Primary Master Latency Timer Register (SATA-D31:F5).....	620
15.1.10	PCMD_BAR—Primary Command Block Base Address Register (SATA-D31:F5)	620
15.1.11	PCNL_BAR—Primary Control Block Base Address Register (SATA-D31:F5).....	620
15.1.12	SCMD_BAR—Secondary Command Block Base Address Register (SATA D31:F5)	621
15.1.13	SCNL_BAR—Secondary Control Block Base Address Register (SATA D31:F5)	621
15.1.14	BAR—Legacy Bus Master Base Address Register (SATA-D31:F5).....	622
15.1.15	SIDPBA—SATA Index/Data Pair Base Address Register (SATA-D31:F5).....	622
15.1.16	SVID—Subsystem Vendor Identification Register (SATA-D31:F5).....	623
15.1.17	SID—Subsystem Identification Register (SATA-D31:F5)	623
15.1.18	CAP—Capabilities Pointer Register (SATA-D31:F5).....	623
15.1.19	INT_LN—Interrupt Line Register (SATA-D31:F5)	623
15.1.20	INT_PN—Interrupt Pin Register (SATA-D31:F5).....	623
15.1.21	IDE_TIM—IDE Timing Register (SATA-D31:F5)	624

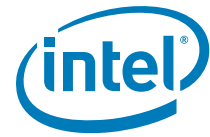

15.1.22	PID—PCI Power Management Capability Identification Register (SATA-D31:F5)	624
15.1.23	PC—PCI Power Management Capabilities Register (SATA-D31:F5)	624
15.1.24	PMCS—PCI Power Management Control and Status Register (SATA-D31:F5)	625
15.1.25	MAP—Address Map Register (SATA-D31:F5)	626
15.1.26	PCS—Port Control and Status Register (SATA-D31:F5)	627
15.1.27	SATACR0—SATA Capability Register 0 (SATA-D31:F5)	628
15.1.28	SATACR1—SATA Capability Register 1 (SATA-D31:F5)	628
15.1.29	FLRCID—FLR Capability ID Register (SATA-D31:F5)	628
15.1.30	FLRCLV—FLR Capability Length and Value Register (SATA-D31:F5)	629
15.1.31	FLRCTRL—FLR Control Register (SATA-D31:F5)	629
15.1.32	ATC—APM Trapping Control Register (SATA-D31:F5)	630
15.1.33	ATC—APM Trapping Control Register (SATA-D31:F5)	630
15.2	Bus Master IDE I/O Registers (D31:F5)	631
15.2.1	BMIC[P,S]—Bus Master IDE Command Register (D31:F5)	632
15.2.2	BMIS[P,S]—Bus Master IDE Status Register (D31:F5)	633
15.2.3	BMID[P,S]—Bus Master IDE Descriptor Table Pointer Register (D31:F5)	633
15.3	Serial ATA Index/Data Pair Superset Registers	634
15.3.1	SINDX—SATA Index Register (D31:F5)	634
15.3.2	SDATA—SATA Index Data Register (D31:F5)	634
15.3.2.1	PxSSTS—Serial ATA Status Register (D31:F5)	635
15.3.2.2	PxSCTL—Serial ATA Control Register (D31:F5)	636
15.3.2.3	PxSERR—Serial ATA Error Register (D31:F5)	637
16	EHCI Controller Registers (D29:F0, D26:F0)	639
16.1	USB EHCI Configuration Registers (USB EHCI—D29:F0, D26:F0)	639
16.1.1	VID—Vendor Identification Register (USB EHCI—D29:F0, D26:F0)	641
16.1.2	DID—Device Identification Register (USB EHCI—D29:F0, D26:F0)	641
16.1.3	PCICMD—PCI Command Register (USB EHCI—D29:F0, D26:F0)	641
16.1.4	PCISTS—PCI Status Register (USB EHCI—D29:F0, D26:F0)	643
16.1.5	RID—Revision Identification Register (USB EHCI—D29:F0, D26:F0)	644
16.1.6	PI—Programming Interface Register (USB EHCI—D29:F0, D26:F0)	644
16.1.7	SCC—Sub Class Code Register (USB EHCI—D29:F0, D26:F0)	644
16.1.8	BCC—Base Class Code Register (USB EHCI—D29:F0, D26:F0)	644
16.1.9	PMLT—Primary Master Latency Timer Register (USB EHCI—D29:F0, D26:F0)	645
16.1.10	HEADTYP—Header Type Register (USB EHCI—D29:F0, D26:F0)	645
16.1.11	MEM_BASE—Memory Base Address Register (USB EHCI—D29:F0, D26:F0)	645
16.1.12	SVID—USB EHCI Subsystem Vendor ID Register (USB EHCI—D29:F0, D26:F0)	646
16.1.13	SID—USB EHCI Subsystem ID Register (USB EHCI—D29:F0, D26:F0)	646
16.1.14	CAP_PTR—Capabilities Pointer Register (USB EHCI—D29:F0, D26:F0)	646
16.1.15	INT_LN—Interrupt Line Register (USB EHCI—D29:F0, D26:F0)	646
16.1.16	INT_PN—Interrupt Pin Register (USB EHCI—D29:F0, D26:F0)	647
16.1.17	PWR_CAPID—PCI Power Management Capability ID Register (USB EHCI—D29:F0, D26:F0)	647
16.1.18	NXT_PTR1—Next Item Pointer #1 Register (USB EHCI—D29:F0, D26:F0)	647



16.1.19	PWR_CAP—Power Management Capabilities Register (USB EHCI—D29:F0, D26:F0)	648
16.1.20	PWR_CNTL_STS—Power Management Control/ Status Register (USB EHCI—D29:F0, D26:F0)	649
16.1.21	DEBUG_CAPID—Debug Port Capability ID Register (USB EHCI—D29:F0, D26:F0)	650
16.1.22	NXT_PTR2—Next Item Pointer #2 Register (USB EHCI—D29:F0, D26:F0)	650
16.1.23	DEBUG_BASE—Debug Port Base Offset Register (USB EHCI—D29:F0, D26:F0)	650
16.1.24	USB_RELNUM—USB Release Number Register (USB EHCI—D29:F0, D26:F0)	650
16.1.25	FL_ADJ—Frame Length Adjustment Register (USB EHCI—D29:F0, D26:F0)	651
16.1.26	PWAKE_CAP—Port Wake Capability Register (USB EHCI—D29:F0, D26:F0)	652
16.1.27	LEG_EXT_CAP—USB EHCI Legacy Support Extended Capability Register (USB EHCI—D29:F0, D26:F0)	653
16.1.28	LEG_EXT_CS—USB EHCI Legacy Support Extended Control / Status Register (USB EHCI—D29:F0, D26:F0)	654
16.1.29	SPECIAL_SMI—Intel Specific USB 2.0 SMI Register (USB EHCI—D29:F0, D26:F0)	656
16.1.30	ACCESS_CNTL—Access Control Register (USB EHCI—D29:F0, D26:F0)	657
16.1.31	EHCIIR1—EHCI Initialization Register 1 (USB EHCI—D29:F0, D26:F0)	658
16.1.32	EHCIIR2—EHCI Initialization Register 2 (USB EHCI—D29:F0, D26:F0)	658
16.1.33	FLR_CID—Function Level Reset Capability ID Register (USB EHCI—D29:F0, D26:F0)	659
16.1.34	FLR_NEXT—Function Level Reset Next Capability Pointer Register (USB EHCI—D29:F0, D26:F0)	659
16.1.35	FLR_CLV—Function Level Reset Capability Length and Version Register (USB EHCI—D29:F0, D26:F0)	660
16.1.36	FLR_CTRL—Function Level Reset Control Register (USB EHCI—D29:F0, D26:F0)	660
16.1.37	FLR_STS—Function Level Reset Status Register (USB EHCI—D29:F0, D26:F0)	661
16.1.38	EHCIIR3—EHCI Initialization Register 3 (USB EHCI—D29:F0, D26:F0)	661
16.1.39	EHCIIR4—EHCI Initialization Register 4 (USB EHCI—D29:F0, D26:F0)	661
16.2	Memory-Mapped I/O Registers	662
16.2.1	Host Controller Capability Registers	662
16.2.1.1	CAPLENGTH—Capability Registers Length Register	663
16.2.1.2	HCIVERSION—Host Controller Interface Version Number Register	663
16.2.1.3	HCSPARAMS—Host Controller Structural Parameters Register	663
16.2.1.4	HCCPARAMS—Host Controller Capability Parameters Register	664
16.2.2	Host Controller Operational Registers	665
16.2.2.1	USB2_0_CMD—USB 2.0 Command Register	666
16.2.2.2	USB2_0_STS—USB 2.0 Status Register	669
16.2.2.3	USB2_0_INTR—USB 2.0 Interrupt Enable Register	671
16.2.2.4	FRINDEX—Frame Index Register	672
16.2.2.5	CTRLDSSEGMENT—Control Data Structure Segment Register	673
16.2.2.6	PERIODICLISTBASE—Periodic Frame List Base Address Register	673
16.2.2.7	ASYNCLISTADDR—Current Asynchronous List Address Register	674
16.2.2.8	CONFIGFLAG—Configure Flag Register	674
16.2.2.9	PORTSC—Port N Status and Control Register	675
16.2.3	USB 2.0-Based Debug Port Registers	680
16.2.3.1	CNTL_STS—Control/Status Register	681
16.2.3.2	USBPID—USB PIDs Register	683
16.2.3.3	DATABUF[7:0]—Data Buffer Bytes[7:0] Register	683
16.2.3.4	CONFIG—Configuration Register	683

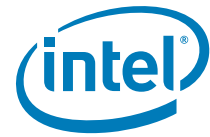

17	Integrated Intel® High Definition Audio Controller Registers	685
17.1	Intel® High Definition Audio Controller Registers (D27:F0).....	685
17.1.1	Intel® High Definition Audio PCI Configuration Space (Intel® High Definition Audio— D27:F0).....	685
17.1.1.1	VID—Vendor Identification Register (Intel® High Definition Audio Controller—D27:F0)	687
17.1.1.2	DID—Device Identification Register (Intel® High Definition Audio Controller—D27:F0)	687
17.1.1.3	PCICMD—PCI Command Register (Intel® High Definition Audio Controller—D27:F0)	688
17.1.1.4	PCISTS—PCI Status Register (Intel® High Definition Audio Controller—D27:F0)	689
17.1.1.5	RID—Revision Identification Register (Intel® High Definition Audio Controller—D27:F0)	689
17.1.1.6	PI—Programming Interface Register (Intel® High Definition Audio Controller—D27:F0)	689
17.1.1.7	SCC—Sub Class Code Register (Intel® High Definition Audio Controller—D27:F0)	690
17.1.1.8	BCC—Base Class Code Register (Intel® High Definition Audio Controller—D27:F0)	690
17.1.1.9	CLS—Cache Line Size Register (Intel® High Definition Audio Controller—D27:F0)	690
17.1.1.10	LT—Latency Timer Register (Intel® High Definition Audio Controller—D27:F0)	690
17.1.1.11	HEADTYP—Header Type Register (Intel® High Definition Audio Controller—D27:F0)	690
17.1.1.12	HDBARL—Intel® High Definition Audio Lower Base Address Register (Intel® High Definition Audio—D27:F0)	691
17.1.1.13	HDBARU—Intel® High Definition Audio Upper Base Address Register (Intel® High Definition Audio Controller—D27:F0).....	691
17.1.1.14	SVID—Subsystem Vendor Identification Register (Intel® High Definition Audio Controller—D27:F0)	691
17.1.1.15	SID—Subsystem Identification Register (Intel® High Definition Audio Controller—D27:F0)	692
17.1.1.16	CAPPTR—Capabilities Pointer Register (Intel® High Definition Audio Controller—D27:F0)	692
17.1.1.17	INTLN—Interrupt Line Register (Intel® High Definition Audio Controller—D27:F0)	692
17.1.1.18	INTPN—Interrupt Pin Register (Intel® High Definition Audio Controller—D27:F0)	692
17.1.1.19	HDCTL—Intel® High Definition Audio Control Register (Intel® High Definition Audio Controller—D27:F0)	693
17.1.1.20	HDINIT1—Intel® High Definition Audio Initialization Register 1 (Intel® High Definition Audio Controller—D27:F0)	693
17.1.1.21	DCKCTL—Docking Control Register (Mobile Only) (Intel® High Definition Audio Controller—D27:F0)	693
17.1.1.22	DCKSTS—Docking Status Register (Mobile Only) (Intel® High Definition Audio Controller—D27:F0)	694
17.1.1.23	PID—PCI Power Management Capability ID Register (Intel® High Definition Audio Controller—D27:F0)	694
17.1.1.24	PC—Power Management Capabilities Register (Intel® High Definition Audio Controller—D27:F0)	695
17.1.1.25	PCS—Power Management Control and Status Register (Intel® High Definition Audio Controller—D27:F0)	695
17.1.1.26	MID—MSI Capability ID Register (Intel® High Definition Audio Controller—D27:F0)	696
17.1.1.27	MMC—MSI Message Control Register (Intel® High Definition Audio Controller—D27:F0)	696
17.1.1.28	MMLA—MSI Message Lower Address Register (Intel® High Definition Audio Controller—D27:F0)	697
17.1.1.29	MMUA—MSI Message Upper Address Register (Intel® High Definition Audio Controller—D27:F0)	697
17.1.1.30	MMD—MSI Message Data Register (Intel® High Definition Audio Controller—D27:F0)	697
17.1.1.31	PXID—PCI Express* Capability ID Register (Intel® High Definition Audio Controller—D27:F0)	697



17.1.1.32	PXC—PCI Express* Capabilities Register (Intel® High Definition Audio Controller—D27:F0)	698
17.1.1.33	DEVCAP—Device Capabilities Register (Intel® High Definition Audio Controller—D27:F0)	698
17.1.1.34	DEVC—Device Control Register (Intel® High Definition Audio Controller—D27:F0)	699
17.1.1.35	DEVS—Device Status Register (Intel® High Definition Audio Controller—D27:F0)	700
17.1.1.36	VCCAP—Virtual Channel Enhanced Capability Header (Intel® High Definition Audio Controller—D27:F0)	700
17.1.1.37	PVCCAP1—Port VC Capability Register 1 (Intel® High Definition Audio Controller—D27:F0)	701
17.1.1.38	PVCCAP2 — Port VC Capability Register 2 (Intel® High Definition Audio Controller—D27:F0)	701
17.1.1.39	PVCCCTL — Port VC Control Register (Intel® High Definition Audio Controller—D27:F0)	701
17.1.1.40	PVCSTS—Port VC Status Register (Intel® High Definition Audio Controller—D27:F0)	702
17.1.1.41	VC0CAP—VC0 Resource Capability Register (Intel® High Definition Audio Controller—D27:F0)	702
17.1.1.42	VC0CTL—VC0 Resource Control Register (Intel® High Definition Audio Controller—D27:F0)	703
17.1.1.43	VC0STS—VC0 Resource Status Register (Intel® High Definition Audio Controller—D27:F0)	703
17.1.1.44	VCiCAP—VCi Resource Capability Register (Intel® High Definition Audio Controller—D27:F0)	704
17.1.1.45	VCiCTL—VCi Resource Control Register (Intel® High Definition Audio Controller—D27:F0)	704
17.1.1.46	VCiSTS—VCi Resource Status Register (Intel® High Definition Audio Controller—D27:F0)	705
17.1.1.47	RCCAP—Root Complex Link Declaration Enhanced Capability Header Register (Intel® High Definition Audio Controller—D27:F0)	705
17.1.1.48	ESD—Element Self Description Register (Intel® High Definition Audio Controller—D27:F0)	705
17.1.1.49	L1DESC—Link 1 Description Register (Intel® High Definition Audio Controller—D27:F0)	706
17.1.1.50	L1ADDL—Link 1 Lower Address Register (Intel® High Definition Audio Controller—D27:F0)	706
17.1.1.51	L1ADDU—Link 1 Upper Address Register (Intel® High Definition Audio Controller—D27:F0)	706
17.1.2	Intel® High Definition Audio Memory Mapped Configuration Registers (Intel® High Definition Audio D27:F0)	707
17.1.2.1	GCAP—Global Capabilities Register (Intel® High Definition Audio Controller—D27:F0)	711
17.1.2.2	VMIN—Minor Version Register (Intel® High Definition Audio Controller—D27:F0)	711
17.1.2.3	VMAJ—Major Version Register (Intel® High Definition Audio Controller—D27:F0)	711
17.1.2.4	OUTPAY—Output Payload Capability Register (Intel® High Definition Audio Controller—D27:F0)	712
17.1.2.5	INPAY—Input Payload Capability Register (Intel® High Definition Audio Controller—D27:F0)	712
17.1.2.6	GCTL—Global Control Register (Intel® High Definition Audio Controller—D27:F0)	713
17.1.2.7	WAKEEN—Wake Enable Register (Intel® High Definition Audio Controller—D27:F0)	714
17.1.2.8	STATESTS—State Change Status Register (Intel® High Definition Audio Controller—D27:F0)	714
17.1.2.9	GSTS—Global Status Register (Intel® High Definition Audio Controller—D27:F0)	715
17.1.2.10	OUTSTRMPAY—Output Stream Payload Capability (Intel® High Definition Audio Controller—D27:F0)	715
17.1.2.11	INSTRMPAY—Input Stream Payload Capability (Intel® High Definition Audio Controller—D27:F0)	715
17.1.2.12	INTCTL—Interrupt Control Register (Intel® High Definition Audio Controller—D27:F0)	716

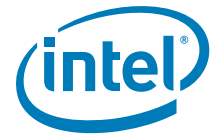

17.1.2.13	INTSTS—Interrupt Status Register (Intel® High Definition Audio Controller—D27:F0)	717
17.1.2.14	WALCLK—Wall Clock Counter Register (Intel® High Definition Audio Controller—D27:F0)	717
17.1.2.15	SSYNC—Stream Synchronization Register (Intel® High Definition Audio Controller—D27:F0)	718
17.1.2.16	CORBIBASE—CORB Lower Base Address Register (Intel® High Definition Audio Controller—D27:F0)	718
17.1.2.17	CORBUBASE—CORB Upper Base Address Register (Intel® High Definition Audio Controller—D27:F0)	719
17.1.2.18	CORBWP—CORB Write Pointer Register (Intel® High Definition Audio Controller—D27:F0)	719
17.1.2.19	CORBRP—CORB Read Pointer Register (Intel® High Definition Audio Controller—D27:F0)	719
17.1.2.20	CORBCTL—CORB Control Register (Intel® High Definition Audio Controller—D27:F0)	720
17.1.2.21	CORBST—CORB Status Register (Intel® High Definition Audio Controller—D27:F0)	720
17.1.2.22	CORBSIZE—CORB Size Register Intel® High Definition Audio Controller—D27:F0)	720
17.1.2.23	RIRBIBASE—RIRB Lower Base Address Register (Intel® High Definition Audio Controller—D27:F0)	721
17.1.2.24	RIRBUBASE—RIRB Upper Base Address Register (Intel® High Definition Audio Controller—D27:F0)	721
17.1.2.25	RIRBWP—RIRB Write Pointer Register (Intel® High Definition Audio Controller—D27:F0)	721
17.1.2.26	RINTCNT—Response Interrupt Count Register (Intel® High Definition Audio Controller—D27:F0)	722
17.1.2.27	RIRBCTL—RIRB Control Register (Intel® High Definition Audio Controller—D27:F0)	722
17.1.2.28	RIRBSTS—RIRB Status Register (Intel® High Definition Audio Controller—D27:F0)	723
17.1.2.29	RIRBSIZE—RIRB Size Register (Intel® High Definition Audio Controller—D27:F0)	723
17.1.2.30	IC—Immediate Command Register (Intel® High Definition Audio Controller—D27:F0)	723
17.1.2.31	IR—Immediate Response Register (Intel® High Definition Audio Controller—D27:F0)	724
17.1.2.32	ICS—Immediate Command Status Register (Intel® High Definition Audio Controller—D27:F0)	724
17.1.2.33	DPLBASE—DMA Position Lower Base Address Register (Intel® High Definition Audio Controller—D27:F0)	725
17.1.2.34	DPUBASE—DMA Position Upper Base Address Register (Intel® High Definition Audio Controller—D27:F0)	725
17.1.2.35	SDCTL—Stream Descriptor Control Register (Intel® High Definition Audio Controller—D27:F0)	726
17.1.2.36	SDSTS—Stream Descriptor Status Register (Intel® High Definition Audio Controller—D27:F0)	727
17.1.2.37	SDLPIB—Stream Descriptor Link Position in Buffer Register (Intel® High Definition Audio Controller—D27:F0)	728
17.1.2.38	SDCBL—Stream Descriptor Cyclic Buffer Length Register (Intel® High Definition Audio Controller—D27:F0)	728
17.1.2.39	SDLVI—Stream Descriptor Last Valid Index Register (Intel® High Definition Audio Controller—D27:F0)	729
17.1.2.40	SDFIFOW—Stream Descriptor FIFO Watermark Register (Intel® High Definition Audio Controller—D27:F0)	729
17.1.2.41	SDFIFOS—Stream Descriptor FIFO Size Register - Input Streams (Intel® High Definition Audio Controller—D27:F0)	730
17.1.2.42	SDFIFOS—Stream Descriptor FIFO Size Register - Output Streams (Intel® High Definition Audio Controller—D27:F0)	730
17.1.2.43	SDFMT—Stream Descriptor Format Register (Intel® High Definition Audio Controller—D27:F0)	731
17.1.2.44	SDBDPL—Stream Descriptor Buffer Descriptor List Pointer Lower Base Address Register (Intel® High Definition Audio Controller—D27:F0)	732



17.1.2.45	SDBDPU—Stream Descriptor Buffer Descriptor List Pointer Upper Base Address Register (Intel® High Definition Audio Controller—D27:F0)	732
17.2	Integrated Digital Display Audio Registers and Verb IDs	733
17.2.1	Configuration Default Register	733
18	SMBus Controller Registers (D31:F3)	739
18.1	PCI Configuration Registers (SMBus—D31:F3)	739
18.1.1	VID—Vendor Identification Register (SMBus—D31:F3)	739
18.1.2	DID—Device Identification Register (SMBus—D31:F3)	740
18.1.3	PCICMD—PCI Command Register (SMBus—D31:F3)	740
18.1.4	PCISTS—PCI Status Register (SMBus—D31:F3)	741
18.1.5	RID—Revision Identification Register (SMBus—D31:F3)	741
18.1.6	PI—Programming Interface Register (SMBus—D31:F3)	742
18.1.7	SCC—Sub Class Code Register (SMBus—D31:F3)	742
18.1.8	BCC—Base Class Code Register (SMBus—D31:F3)	742
18.1.9	SMBMBAR0—D31_F3_SMBus Memory Base Address 0 Register (SMBus—D31:F3)	742
18.1.10	SMBMBAR1—D31_F3_SMBus Memory Base Address 1 Register (SMBus—D31:F3)	743
18.1.11	SMB_BASE—SMBus Base Address Register (SMBus—D31:F3)	743
18.1.12	SVID—Subsystem Vendor Identification Register (SMBus—D31:F2/F4)	743
18.1.13	SID—Subsystem Identification Register (SMBus—D31:F2/F4)	744
18.1.14	INT_LN—Interrupt Line Register (SMBus—D31:F3)	744
18.1.15	INT_PN—Interrupt Pin Register (SMBus—D31:F3)	744
18.1.16	HOSTC—Host Configuration Register (SMBus—D31:F3)	745
18.2	SMBus I/O and Memory Mapped I/O Registers	746
18.2.1	HST_STS—Host Status Register (SMBus—D31:F3)	747
18.2.2	HST_CNT—Host Control Register (SMBus—D31:F3)	748
18.2.3	HST_CMD—Host Command Register (SMBus—D31:F3)	750
18.2.4	XMIT_SLVA—Transmit Slave Address Register (SMBus—D31:F3)	750
18.2.5	HST_D0—Host Data 0 Register (SMBus—D31:F3)	750
18.2.6	HST_D1—Host Data 1 Register (SMBus—D31:F3)	750
18.2.7	Host_BLOCK_DB—Host Block Data Byte Register (SMBus—D31:F3)	751
18.2.8	PEC—Packet Error Check (PEC) Register (SMBus—D31:F3)	751
18.2.9	RCV_SLVA—Receive Slave Address Register (SMBus—D31:F3)	752
18.2.10	SLV_DATA—Receive Slave Data Register (SMBus—D31:F3)	752
18.2.11	AUX_STS—Auxiliary Status Register (SMBus—D31:F3)	752
18.2.12	AUX_CTL—Auxiliary Control Register (SMBus—D31:F3)	753
18.2.13	SMLINK_PIN_CTL—SMLink Pin Control Register (SMBus—D31:F3)	753
18.2.14	SMBus_PIN_CTL—SMBus Pin Control Register (SMBus—D31:F3)	754
18.2.15	SLV_STS—Slave Status Register (SMBus—D31:F3)	754
18.2.16	SLV_CMD—Slave Command Register (SMBus—D31:F3)	755
18.2.17	NOTIFY_DADDR—Notify Device Address Register (SMBus—D31:F3)	755
18.2.18	NOTIFY_DLOW—Notify Data Low Byte Register (SMBus—D31:F3)	756
18.2.19	NOTIFY_DHIGH—Notify Data High Byte Register (SMBus—D31:F3)	756
19	PCI Express* Configuration Registers	757
19.1	PCI Express* Configuration Registers (PCI Express*—D28:F0/F1/F2/F3/F4/F5/F6/F7)	757
19.1.1	VID—Vendor Identification Register (PCI Express*—D28:F0/F1/F2/F3/F4/F5/F6/F7)	759
19.1.2	DID—Device Identification Register (PCI Express*—D28:F0/F1/F2/F3/F4/F5/F6/F7)	759

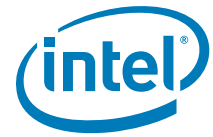

19.1.3	PCICMD—PCI Command Register (PCI Express*—D28:F0/F1/F2/F3/F4/F5/F6/F7/F6/F7)	760
19.1.4	PCISTS—PCI Status Register (PCI Express*—D28:F0/F1/F2/F3/F4/F5/F6/F7/F6/F7)	761
19.1.5	RID—Revision Identification Register (PCI Express*—D28:F0/F1/F2/F3/F4/F5/F6/F7/F6/F7)	762
19.1.6	PI—Programming Interface Register (PCI Express*—D28:F0/F1/F2/F3/F4/F5/F6/F7/F6/F7)	762
19.1.7	SCC—Sub Class Code Register (PCI Express*—D28:F0/F1/F2/F3/F4/F5/F6/F7/F6/F7)	762
19.1.8	BCC—Base Class Code Register (PCI Express*—D28:F0/F1/F2/F3/F4/F5/F6/F7/F6/F7)	762
19.1.9	CLS—Cache Line Size Register (PCI Express*—D28:F0/F1/F2/F3/F4/F5/F6/F7/F6/F7)	763
19.1.10	PLT—Primary Latency Timer Register (PCI Express*—D28:F0/F1/F2/F3/F4/F5/F6/F7/F6/F7)	763
19.1.11	HEADTYP—Header Type Register (PCI Express*—D28:F0/F1/F2/F3/F4/F5/F6/F7/F6/F7)	763
19.1.12	BNUM—Bus Number Register (PCI Express*—D28:F0/F1/F2/F3/F4/F5/F6/F7/F6/F7)	764
19.1.13	SLT—Secondary Latency Timer Register (PCI Express*—D28:F0/F1/F2/F3/F4/F5/F6/F7/F6/F7)	764
19.1.14	IOBL—I/O Base and Limit Register (PCI Express*—D28:F0/F1/F2/F3/F4/F5/F6/F7/F6/F7)	764
19.1.15	SSTS—Secondary Status Register (PCI Express*—D28:F0/F1/F2/F3/F4/F5/F6/F7/F6/F7)	765
19.1.16	MBL—Memory Base and Limit Register (PCI Express*—D28:F0/F1/F2/F3/F4/F5/F6/F7/F6/F7)	766
19.1.17	PMBL—Prefetchable Memory Base and Limit Register (PCI Express*—D28:F0/F1/F2/F3/F4/F5/F6/F7/F6/F7)	766
19.1.18	PMBU32—Prefetchable Memory Base Upper 32 Bits Register (PCI Express*—D28:F0/F1/F2/F3/F4/F5/F6/F7/F6/F7)	767
19.1.19	PMLU32—Prefetchable Memory Limit Upper 32 Bits Register (PCI Express*—D28:F0/F1/F2/F3/F4/F5/F6/F7/F6/F7)	767
19.1.20	CAPP—Capabilities List Pointer Register (PCI Express*—D28:F0/F1/F2/F3/F4/F5/F6/F7/F6/F7)	767
19.1.21	INTR—Interrupt Information Register (PCI Express*—D28:F0/F1/F2/F3/F4/F5/F6/F7/F6/F7)	768
19.1.22	BCTRL—Bridge Control Register (PCI Express*—D28:F0/F1/F2/F3/F4/F5/F6/F7/F6/F7)	769
19.1.23	CLIST—Capabilities List Register (PCI Express*—D28:F0/F1/F2/F3/F4/F5/F6/F7)	770
19.1.24	XCAP—PCI Express* Capabilities Register (PCI Express*—D28:F0/F1/F2/F3/F4/F5/F6/F7)	770
19.1.25	DCAP—Device Capabilities Register (PCI Express*—D28:F0/F1/F2/F3/F4/F5/F6/F7)	771
19.1.26	DCTL—Device Control Register (PCI Express*—D28:F0/F1/F2/F3/F4/F5/F6/F7)	772
19.1.27	DSTS—Device Status Register (PCI Express*—D28:F0/F1/F2/F3/F4/F5/F6/F7)	773
19.1.28	LCAP—Link Capabilities Register (PCI Express*—D28:F0/F1/F2/F3/F4/F5/F6/F7)	774
19.1.29	LCTL—Link Control Register (PCI Express*—D28:F0/F1/F2/F3/F4/F5/F6/F7)	776
19.1.30	LSTS—Link Status Register (PCI Express*—D28:F0/F1/F2/F3/F4/F5/F6/F7)	777
19.1.31	SLCAP—Slot Capabilities Register (PCI Express*—D28:F0/F1/F2/F3/F4/F5/F6/F7)	778
19.1.32	SLCTL—Slot Control Register (PCI Express*—D28:F0/F1/F2/F3/F4/F5/F6/F7)	779
19.1.33	SLSTS—Slot Status Register (PCI Express*—D28:F0/F1/F2/F3/F4/F5/F6/F7)	780
19.1.34	RCTL—Root Control Register (PCI Express*—D28:F0/F1/F2/F3/F4/F5/F6/F7)	781
19.1.35	RSTS—Root Status Register (PCI Express*—D28:F0/F1/F2/F3/F4/F5/F6/F7)	781

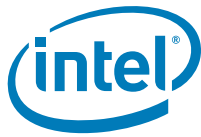

19.1.36	DCAP2—Device Capabilities 2 Register (PCI Express*—D28:F0/F1/F2/F3/F4/F5/F6/F7)	782
19.1.37	DCTL2—Device Control 2 Register (PCI Express*—D28:F0/F1/F2/F3/F4/F5/F6/F7)	782
19.1.38	LCTL2—Link Control 2 Register (PCI Express*—D28:F0/F1/F2/F3/F4/F5/F6/F7)	783
19.1.39	LSTS2—Link Status 2 Register (PCI Express*—D28:F0/F1/F2/F3/F4/F5/F6/F7)	784
19.1.40	MID—Message Signaled Interrupt Identifiers Register (PCI Express*—D28:F0/F1/F2/F3/F4/F5/F6/F7)	784
19.1.41	MC—Message Signaled Interrupt Message Control Register (PCI Express*—D28:F0/F1/F2/F3/F4/F5/F6/F7)	784
19.1.42	MA—Message Signaled Interrupt Message Address Register (PCI Express*—D28:F0/F1/F2/F3/F4/F5/F6/F7)	785
19.1.43	MD—Message Signaled Interrupt Message Data Register (PCI Express*—D28:F0/F1/F2/F3/F4/F5/F6/F7)	785
19.1.44	SVCAP—Subsystem Vendor Capability Register (PCI Express*—D28:F0/F1/F2/F3/F4/F5/F6/F7)	785
19.1.45	SVID—Subsystem Vendor Identification Register (PCI Express*—D28:F0/F1/F2/F3/F4/F5/F6/F7)	785
19.1.46	PMCAP—Power Management Capability Register (PCI Express*—D28:F0/F1/F2/F3/F4/F5/F6/F7)	786
19.1.47	PMC—PCI Power Management Capabilities Register (PCI Express*—D28:F0/F1/F2/F3/F4/F5/F6/F7)	786
19.1.48	PMCS—PCI Power Management Control and Status Register (PCI Express*—D28:F0/F1/F2/F3/F4/F5/F6/F7)	787
19.1.49	MPC2—Miscellaneous Port Configuration Register 2 (PCI Express*—D28:F0/F1/F2/F3/F4/F5/F6/F7)	788
19.1.50	MPC—Miscellaneous Port Configuration Register (PCI Express*—D28:F0/F1/F2/F3/F4/F5/F6/F7)	789
19.1.51	SMSCS—SMI/SCI Status Register (PCI Express*—D28:F0/F1/F2/F3/F4/F5/F6/F7)	791
19.1.52	RPDCGEN—Root Port Dynamic Clock Gating Enable Register (PCI Express—D28:F0/F1/F2/F3/F4/F5/F6/F7)	792
19.1.53	PECR1—PCI Express* Configuration Register 1 (PCI Express*—D28:F0/F1/F2/F3/F4/F5/F6/F7)	792
19.1.54	PECR3—PCI Express* Configuration Register 3 (PCI Express*—D28:F0/F1/F2/F3/F4/F5/F6/F7)	793
19.1.55	UES—Uncorrectable Error Status Register (PCI Express*—D28:F0/F1/F2/F3/F4/F5/F6/F7)	794
19.1.56	UEM—Uncorrectable Error Mask Register (PCI Express*—D28:F0/F1/F2/F3/F4/F5/F6/F7)	795
19.1.57	UEV — Uncorrectable Error Severity Register (PCI Express*—D28:F0/F1/F2/F3/F4/F5/F6/F7)	796
19.1.58	CES — Correctable Error Status Register (PCI Express*—D28:F0/F1/F2/F3/F4/F5/F6/F7)	797
19.1.59	CEM — Correctable Error Mask Register (PCI Express*—D28:F0/F1/F2/F3/F4/F5/F6/F7)	797
19.1.60	AECC — Advanced Error Capabilities and Control Register (PCI Express*—D28:F0/F1/F2/F3/F4/F5/F6/F7)	798
19.1.61	RES — Root Error Status Register (PCI Express*—D28:F0/F1/F2/F3/F4/F5/F6/F7)	798
19.1.62	PECR2 — PCI Express* Configuration Register 2 (PCI Express*—D28:F0/F1/F2/F3/F4/F5/F6/F7)	799
19.1.63	PEETM — PCI Express* Extended Test Mode Register (PCI Express*—D28:F0/F1/F2/F3/F4/F5/F6/F7)	799
19.1.64	PEC1 — PCI Express* Configuration Register 1 (PCI Express*—D28:F0/F1/F2/F3/F4/F5/F6/F7)	799
20	High Precision Event Timer Registers	801
20.1	Memory Mapped Registers	801
20.1.1	GCAP_ID—General Capabilities and Identification Register	803
20.1.2	GEN_CONF—General Configuration Register	803
20.1.3	GINTR_STA—General Interrupt Status Register	804
20.1.4	MAIN_CNT—Main Counter Value Register	804
20.1.5	TIMn_CONF—Timer n Configuration and Capabilities Register	805
20.1.6	TIMn_COMP—Timer n Comparator Value Register	808

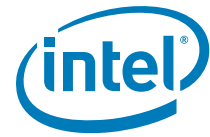

20.1.7	TIMERn_PROCMSG_ROUT—Timer n Processor Message Interrupt Rout Register.....	809
21	Serial Peripheral Interface (SPI)	811
21.1	Serial Peripheral Interface Memory Mapped Configuration Registers	811
21.1.1	BFPR—BIOS Flash Primary Region Register (SPI Memory Mapped Configuration Registers).....	813
21.1.2	HSFS—Hardware Sequencing Flash Status Register (SPI Memory Mapped Configuration Registers).....	813
21.1.3	HSFC—Hardware Sequencing Flash Control Register (SPI Memory Mapped Configuration Registers).....	815
21.1.4	FADDR—Flash Address Register (SPI Memory Mapped Configuration Registers).....	815
21.1.5	FDATA0—Flash Data 0 Register (SPI Memory Mapped Configuration Registers).....	816
21.1.6	FDATAN—Flash Data [N] Register (SPI Memory Mapped Configuration Registers).....	816
21.1.7	FRAP—Flash Regions Access Permissions Register (SPI Memory Mapped Configuration Registers).....	817
21.1.8	FREG0—Flash Region 0 (Flash Descriptor) Register (SPI Memory Mapped Configuration Registers).....	818
21.1.9	FREG1—Flash Region 1 (BIOS Descriptor) Register (SPI Memory Mapped Configuration Registers).....	818
21.1.10	FREG2—Flash Region 2 (Intel® ME) Register (SPI Memory Mapped Configuration Registers).....	819
21.1.11	FREG3—Flash Region 3 (GbE) Register (SPI Memory Mapped Configuration Registers).....	819
21.1.12	FREG4—Flash Region 4 (Platform Data) Register (SPI Memory Mapped Configuration Registers).....	820
21.1.13	PR0—Protected Range 0 Register (SPI Memory Mapped Configuration Registers).....	820
21.1.14	PR1—Protected Range 1 Register (SPI Memory Mapped Configuration Registers).....	821
21.1.15	PR2—Protected Range 2 Register (SPI Memory Mapped Configuration Registers).....	822
21.1.16	PR3—Protected Range 3 Register (SPI Memory Mapped Configuration Registers).....	823
21.1.17	PR4—Protected Range 4 Register (SPI Memory Mapped Configuration Registers).....	824
21.1.18	SSFS—Software Sequencing Flash Status Register (SPI Memory Mapped Configuration Registers).....	825
21.1.19	SSFC—Software Sequencing Flash Control Register (SPI Memory Mapped Configuration Registers).....	826
21.1.20	PREOP—Prefix Opcode Configuration Register (SPI Memory Mapped Configuration Registers).....	827
21.1.21	OPTYPE—Opcode Type Configuration Register (SPI Memory Mapped Configuration Registers).....	827
21.1.22	OPMENU—Opcode Menu Configuration Register (SPI Memory Mapped Configuration Registers).....	828
21.1.23	BBAR—BIOS Base Address Configuration Register (SPI Memory Mapped Configuration Registers).....	829
21.1.24	FDOC—Flash Descriptor Observability Control Register (SPI Memory Mapped Configuration Registers).....	829
21.1.25	FDOD—Flash Descriptor Observability Data Register (SPI Memory Mapped Configuration Registers).....	830
21.1.26	AFC—Additional Flash Control Register (SPI Memory Mapped Configuration Registers).....	830
21.1.27	LVSCC— Host Lower Vendor Specific Component Capabilities Register (SPI Memory Mapped Configuration Registers).....	830
21.1.28	UVSCC— Host Upper Vendor Specific Component Capabilities Register (SPI Memory Mapped Configuration Registers).....	832
21.1.29	FPB — Flash Partition Boundary Register (SPI Memory Mapped Configuration Registers).....	833
21.1.30	SRDL — Soft Reset Data Lock Register (SPI Memory Mapped Configuration Registers).....	834
21.1.31	SRDC — Soft Reset Data Control Register (SPI Memory Mapped Configuration Registers).....	834



21.1.32	SRD — Soft Reset Data Register (SPI Memory Mapped Configuration Registers)	834
21.2	Flash Descriptor Records.....	835
21.3	OEM Section	835
21.4	GbE SPI Flash Program Registers	835
21.4.1	GLFPR —Gigabit LAN Flash Primary Region Register (GbE LAN Memory Mapped Configuration Registers)	836
21.4.2	HSFS—Hardware Sequencing Flash Status Register (GbE LAN Memory Mapped Configuration Registers)	836
21.4.3	HSFC—Hardware Sequencing Flash Control Register (GbE LAN Memory Mapped Configuration Registers)	838
21.4.4	FADDR—Flash Address Register (GbE LAN Memory Mapped Configuration Registers)	838
21.4.5	FDATA0—Flash Data 0 Register (GbE LAN Memory Mapped Configuration Registers)	839
21.4.6	FRAP—Flash Regions Access Permissions Register (GbE LAN Memory Mapped Configuration Registers)	839
21.4.7	FREG0—Flash Region 0 (Flash Descriptor) Register (GbE LAN Memory Mapped Configuration Registers)	840
21.4.8	FREG1—Flash Region 1 (BIOS Descriptor) Register (GbE LAN Memory Mapped Configuration Registers)	840
21.4.9	FREG2—Flash Region 2 (Intel® ME) Register (GbE LAN Memory Mapped Configuration Registers)	840
21.4.10	FREG3—Flash Region 3 (GbE) Register (GbE LAN Memory Mapped Configuration Registers)	841
21.4.11	PRO—Protected Range 0 Register (GbE LAN Memory Mapped Configuration Registers)	841
21.4.12	PR1—Protected Range 1 Register (GbE LAN Memory Mapped Configuration Registers)	842
21.4.13	SSFS—Software Sequencing Flash Status Register (GbE LAN Memory Mapped Configuration Registers)	843
21.4.14	SSFC—Software Sequencing Flash Control Register (GbE LAN Memory Mapped Configuration Registers)	844
21.4.15	PREOP—Prefix Opcode Configuration Register (GbE LAN Memory Mapped Configuration Registers)	845
21.4.16	OPTYPE—Opcode Type Configuration Register (GbE LAN Memory Mapped Configuration Registers)	845
21.4.17	OPMENU—Opcode Menu Configuration Register (GbE LAN Memory Mapped Configuration Registers)	846
22	Thermal Sensor Registers (D31:F6)	847
22.1	PCI Bus Configuration Registers.....	847
22.1.1	VID—Vendor Identification Register	848
22.1.2	DID—Device Identification Register.....	848
22.1.3	CMD—Command Register	848
22.1.4	STS—Status Register	849
22.1.5	RID—Revision Identification Register.....	849
22.1.6	PI— Programming Interface Register.....	849
22.1.7	SCC—Sub Class Code Register	850
22.1.8	BCC—Base Class Code Register	850
22.1.9	CLS—Cache Line Size Register	850
22.1.10	LT—Latency Timer Register.....	850
22.1.11	HTYPE—Header Type Register	850
22.1.12	TBAR—Thermal Base Register	851
22.1.13	TBARH—Thermal Base High DWord Register	851
22.1.14	SVID—Subsystem Vendor ID Register	851
22.1.15	SID—Subsystem ID Register	852
22.1.16	CAP_PTR—Capabilities Pointer Register	852
22.1.17	INTLN—Interrupt Line Register.....	852
22.1.18	INTPN—Interrupt Pin Register	852
22.1.19	TBARB—BIOS Assigned Thermal Base Address Register	853
22.1.20	TBARBH—BIOS Assigned Thermal Base High DWord Register	853
22.1.21	PID—PCI Power Management Capability ID Register.....	853
22.1.22	PC—Power Management Capabilities Register	854
22.1.23	PCS—Power Management Control And Status Register.....	854

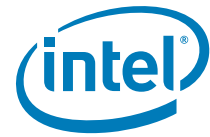

22.2	Thermal Memory Mapped Configuration Registers (Thermal Sensor - D31:F26)	855
22.2.1	TSIU—Thermal Sensor In Use Register	856
22.2.2	TSE—Thermal Sensor Enable Register.....	856
22.2.3	TSS—Thermal Sensor Status Register.....	856
22.2.4	TSTR—Thermal Sensor Thermometer Read Register	857
22.2.5	TSTTP—Thermal Sensor Temperature Trip Point Register.....	857
22.2.6	TSCO—Thermal Sensor Catastrophic Lock-Down Register.....	858
22.2.7	TSES—Thermal Sensor Error Status Register	859
22.2.8	TSGPEN—Thermal Sensor General Purpose Event Enable Register	860
22.2.9	TSPC—Thermal Sensor Policy Control Register	861
22.2.10	PTA—PCH Temperature Adjust Register.....	862
22.2.11	TRC—Thermal Reporting Control Register	862
22.2.12	AE—Alert Enable Register.....	863
22.2.13	PTL—Processor Temperature Limit Register	863
22.2.14	PTV — Processor Temperature Value Register	863
22.2.15	TT—Thermal Throttling Register.....	864
22.2.16	PHL—PCH Hot Level Register	864
22.2.17	TSPIEN—Thermal Sensor PCI Interrupt Enable Register.....	865
22.2.18	TSLOCK—Thermal Sensor Register Lock Control Register.....	866
22.2.19	TC2—Thermal Compares 2 Register.....	866
22.2.20	DTV—DIMM Temperature Values Register	867
22.2.21	ITV—Internal Temperature Values Register	867
23	Intel® Management Engine Subsystem Registers (D22:F[3:0])	869
23.1	First Intel® Management Engine Interface (Intel® MEI) Configuration Registers (Intel® MEI 1 - D22:F0)	869
23.1.1	PCI Configuration Registers (Intel® MEI 1—D22:F0)	869
23.1.1.1	VID—Vendor Identification Register (Intel® MEI 1—D22:F0).....	870
23.1.1.2	DID—Device Identification Register (Intel® MEI 1—D22:F0).....	870
23.1.1.3	PCICMD—PCI Command Register (Intel® MEI 1—D22:F0).....	871
23.1.1.4	PCISTS—PCI Status Register (Intel® MEI 1—D22:F0).....	871
23.1.1.5	RID—Revision Identification Register (Intel® MEI 1—D22:F0).....	872
23.1.1.6	CC—Class Code Register (Intel® MEI 1—D22:F0).....	872
23.1.1.7	HTYPE—Header Type Register (Intel® MEI 1—D22:F0).....	872
23.1.1.8	MEI0_MBAR—MEI0 MMIO Base Address Register (Intel® MEI 1—D22:F0).....	872
23.1.1.9	SVID—Subsystem Vendor ID Register (Intel® MEI 1—D22:F0).....	873
23.1.1.10	SID—Subsystem ID Register (Intel® MEI 1—D22:F0).....	873
23.1.1.11	CAPP—Capabilities List Pointer Register (Intel® MEI 1—D22:F0).....	873
23.1.1.12	INTR—Interrupt Information Register (Intel® MEI 1—D22:F0).....	873
23.1.1.13	HFS—Host Firmware Status Register (Intel® MEI 1—D22:F0).....	874
23.1.1.14	ME_UMA—Intel® Management Engine UMA Register (Intel® MEI 1—D22:F0).....	874
23.1.1.15	GMES—General Intel® ME Status Register (Intel® MEI 1—D22:F0).....	875
23.1.1.16	H_GS—Host General Status Register (Intel® MEI 1—D22:F0).....	875
23.1.1.17	PID—PCI Power Management Capability ID Register (Intel® MEI 1—D22:F0).....	875
23.1.1.18	PC—PCI Power Management Capabilities Register (Intel® MEI 1—D22:F0).....	875



23.1.1.19	PMCS—PCI Power Management Control and Status Register (Intel® MEI 1—D22:F0)	876
23.1.1.20	MID—Message Signaled Interrupt Identifiers Register (Intel® MEI 1—D22:F0)	876
23.1.1.21	MC—Message Signaled Interrupt Message Control Register (Intel® MEI 1—D22:F0)	877
23.1.1.22	MA—Message Signaled Interrupt Message Address Register (Intel® MEI 1—D22:F0)	877
23.1.1.23	MUA—Message Signaled Interrupt Upper Address Register (Intel® MEI 1—D22:F0)	877
23.1.1.24	MD—Message Signaled Interrupt Message Data Register (Intel® MEI 1—D22:F0)	877
23.1.1.25	HIDM—MEI Interrupt Delivery Mode Register (Intel® MEI 1—D22:F0)	878
23.1.1.26	HERES—Intel® MEI Extend Register Status (Intel® MEI 1—D22:F0)	878
23.1.1.27	HERX—Intel® MEI Extend Register DWX (Intel® MEI 1—D22:F0)	879
23.1.2	MEIO_MBAR—Intel® MEI 1 MMIO Registers	879
23.1.2.1	H_CB_WW—Host Circular Buffer Write Window Register (Intel® MEI 1 MMIO Register)	879
23.1.2.2	H_CSR—Host Control Status Register (Intel® MEI 1 MMIO Register)	880
23.1.2.3	ME_CB_RW—Intel® ME Circular Buffer Read Window Register (Intel® MEI 1 MMIO Register)	881
23.1.2.4	ME_CSR_HA—Intel® ME Control Status Host Access Register (Intel® MEI 1 MMIO Register)	881
23.2	Second Intel® Management Engine Interface (Intel® MEI 2) Configuration Registers (Intel® MEI 2—D22:F1)	882
23.2.1	PCI Configuration Registers (Intel® MEI 2—D22:F2)	882
23.2.1.1	VID—Vendor Identification Register (Intel® MEI 2—D22:F1)	883
23.2.1.2	DID—Device Identification Register (Intel® MEI 2—D22:F1)	883
23.2.1.3	PCICMD—PCI Command Register (Intel® MEI 2—D22:F1)	884
23.2.1.4	PCISTS—PCI Status Register (Intel® MEI 2—D22:F1)	884
23.2.1.5	RID—Revision Identification Register (Intel® MEI 2—D22:F1)	885
23.2.1.6	CC—Class Code Register (Intel® MEI 2—D22:F1)	885
23.2.1.7	HTYPE—Header Type Register (Intel® MEI 2—D22:F1)	885
23.2.1.8	MEI_MBAR—Intel® MEI MMIO Base Address Register (Intel® MEI 2—D22:F1)	885
23.2.1.9	SVID—Subsystem Vendor ID Register (Intel® MEI 2—D22:F1)	886
23.2.1.10	SID—Subsystem ID Register (Intel® MEI 2—D22:F1)	886
23.2.1.11	CAPP—Capabilities List Pointer Register (Intel® MEI 2—D22:F1)	886
23.2.1.12	INTR—Interrupt Information Register (Intel® MEI 2—D22:F1)	886
23.2.1.13	HFS—Host Firmware Status Register (Intel® MEI 2—D22:F1)	887
23.2.1.14	GMES—General Intel® ME Status Register (Intel® MEI 2—D22:F1)	887
23.2.1.15	H_GS—Host General Status Register (Intel® MEI 2—D22:F1)	887
23.2.1.16	PID—PCI Power Management Capability ID Register (Intel® MEI 2—D22:F1)	888
23.2.1.17	PC—PCI Power Management Capabilities Register (Intel® MEI 2—D22:F1)	888
23.2.1.18	PMCS—PCI Power Management Control and Status Register (Intel® MEI 2—D22:F1)	888

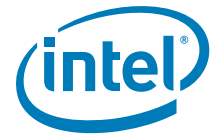

23.2.1.19	MID—Message Signaled Interrupt Identifiers Register (Intel® MEI 2—D22:F1)	889
23.2.1.20	MC—Message Signaled Interrupt Message Control Register (Intel® MEI 2—D22:F1)	889
23.2.1.21	MA—Message Signaled Interrupt Message Address Register (Intel® MEI 2—D22:F1)	889
23.2.1.22	MUA—Message Signaled Interrupt Upper Address Register (Intel® MEI 2—D22:F1)	890
23.2.1.23	MD—Message Signaled Interrupt Message Data Register (Intel® MEI 2—D22:F1)	890
23.2.1.24	HIDM—Intel® MEI Interrupt Delivery Mode Register (Intel® MEI 2—D22:F1)	890
23.2.1.25	HERES—Intel® MEI Extend Register Status (Intel® MEI 2—D22:F1)	891
23.2.1.26	HERX—Intel® MEI Extend Register DWX (Intel® MEI 2—D22:F1)	891
23.2.2	MEI1_MBAR—Intel® MEI 2 MMIO Registers	892
23.2.2.1	H_CB_WW—Host Circular Buffer Write Window (Intel® MEI 2 MMIO Register)	892
23.2.2.2	H_CSR—Host Control Status Register (Intel® MEI 2 MMIO Register)	893
23.2.2.3	ME_CB_RW—Intel® ME Circular Buffer Read Window Register (Intel® MEI 2 MMIO Register)	894
23.2.2.4	ME_CSR_HA—Intel® ME Control Status Host Access Register (Intel® MEI 2 MMIO Register)	894
23.3	IDE Redirect IDER Registers (IDER — D22:F2)	895
23.3.1	PCI Configuration Registers (IDER—D22:F2)	895
23.3.1.1	VID—Vendor Identification Register (IDER—D22:F2)	896
23.3.1.2	DID—Device Identification Register (IDER—D22:F2)	896
23.3.1.3	PCICMD—PCI Command Register (IDER—D22:F2)	896
23.3.1.4	PCISTS—PCI Device Status Register (IDER—D22:F2)	897
23.3.1.5	RID—Revision Identification Register (IDER—D22:F2)	897
23.3.1.6	CC—Class Codes Register (IDER—D22:F2)	897
23.3.1.7	CLS—Cache Line Size Register (IDER—D22:F2)	897
23.3.1.8	PCMDBA—Primary Command Block IO Bar Register (IDER—D22:F2)	898
23.3.1.9	PCTLBA—Primary Control Block Base Address Register (IDER—D22:F2)	898
23.3.1.10	SCMDBA—Secondary Command Block Base Address Register (IDER—D22:F2)	898
23.3.1.11	SCTLBA—Secondary Control Block base Address Register (IDER—D22:F2)	899
23.3.1.12	LBAR—Legacy Bus Master Base Address Register (IDER—D22:F2)	899
23.3.1.13	SVID—Subsystem Vendor ID Register (IDER—D22:F2)	899
23.3.1.14	SID—Subsystem ID Register (IDER—D22:F2)	899
23.3.1.15	CAPP—Capabilities List Pointer Register (IDER—D22:F2)	900
23.3.1.16	INTR—Interrupt Information Register (IDER—D22:F2)	900
23.3.1.17	PID—PCI Power Management Capability ID Register (IDER—D22:F2)	900
23.3.1.18	PC—PCI Power Management Capabilities Register (IDER—D22:F2)	901
23.3.1.19	PMCS—PCI Power Management Control and Status Register (IDER—D22:F2)	901
23.3.1.20	MID—Message Signaled Interrupt Capability ID Register (IDER—D22:F2)	902
23.3.1.21	MC—Message Signaled Interrupt Message Control Register (IDER—D22:F2)	902
23.3.1.22	MA—Message Signaled Interrupt Message Address Register (IDER—D22:F2)	902
23.3.1.23	MAU—Message Signaled Interrupt Message Upper Address Register (IDER—D22:F2)	902
23.3.1.24	MD—Message Signaled Interrupt Message Data Register (IDER—D22:F2)	903
23.3.2	IDER BAR0 Registers	903



23.3.2.1	IDEDATA—IDE Data Register (IDER—D22:F2).....	904
23.3.2.2	IDEERD1—IDE Error Register DEV1 (IDER—D22:F2).....	904
23.3.2.3	IDEERD0—IDE Error Register DEV0 (IDER—D22:F2).....	905
23.3.2.4	IDEFR—IDE Features Register (IDER—D22:F2).....	905
23.3.2.5	IDESCIR—IDE Sector Count In Register (IDER—D22:F2).....	905
23.3.2.6	IDESCOR1—IDE Sector Count Out Register Device 1 Register (IDER—D22:F2).....	906
23.3.2.7	IDESCOR0—IDE Sector Count Out Register Device 0 Register (IDER—D22:F2).....	906
23.3.2.8	IDESNOR0—IDE Sector Number Out Register Device 0 Register (IDER—D22:F2).....	906
23.3.2.9	IDESNOR1—IDE Sector Number Out Register Device 1 Register (IDER—D22:F2).....	907
23.3.2.10	IDESNIR—IDE Sector Number In Register (IDER—D22:F2).....	907
23.3.2.11	IDECLIR—IDE Cylinder Low In Register (IDER—D22:F2).....	907
23.3.2.12	IDCLOR1—IDE Cylinder Low Out Register Device 1 Register (IDER—D22:F2).....	908
23.3.2.13	IDCLOR0—IDE Cylinder Low Out Register Device 0 Register (IDER—D22:F2).....	908
23.3.2.14	IDCHOR0—IDE Cylinder High Out Register Device 0 Register (IDER—D22:F2).....	908
23.3.2.15	IDCHOR1—IDE Cylinder High Out Register Device 1 Register (IDER—D22:F2).....	909
23.3.2.16	IDECHIR—IDE Cylinder High In Register (IDER—D22:F2).....	909
23.3.2.17	IDEDHIR—IDE Drive/Head In Register (IDER—D22:F2).....	909
23.3.2.18	IDDHOR1—IDE Drive Head Out Register Device 1 Register (IDER—D22:F2).....	910
23.3.2.19	IDDHOR0—IDE Drive Head Out Register Device 0 Register (IDER—D22:F2).....	910
23.3.2.20	IDESD0R—IDE Status Device 0 Register (IDER—D22:F2).....	911
23.3.2.21	IDESD1R—IDE Status Device 1 Register (IDER—D22:F2).....	912
23.3.2.22	IDECR—IDE Command Register (IDER—D22:F2).....	912
23.3.3	IDER BAR1 Registers.....	913
23.3.3.1	IDDCR—IDE Device Control Register (IDER—D22:F2).....	913
23.3.3.2	IDASR—IDE Alternate Status Register (IDER—D22:F2).....	913
23.3.4	IDER BAR4 Registers.....	914
23.3.4.1	IDEPBMCR—IDE Primary Bus Master Command Register (IDER—D22:F2).....	915
23.3.4.2	IDEPBMDS0R—IDE Primary Bus Master Device Specific 0 Register (IDER—D22:F2).....	915
23.3.4.3	IDEPBMSR—IDE Primary Bus Master Status Register (IDER—D22:F2).....	916
23.3.4.4	IDEPBMDS1R—IDE Primary Bus Master Device Specific 1 Register (IDER—D22:F2).....	916
23.3.4.5	IDEPBMDTPR0—IDE Primary Bus Master Descriptor Table Pointer Byte 0 Register (IDER—D22:F2).....	916
23.3.4.6	IDEPBMDTPR1—IDE Primary Bus Master Descriptor Table Pointer Byte 1 Register (IDER—D22:F2).....	917
23.3.4.7	IDEPBMDTPR2—IDE Primary Bus Master Descriptor Table Pointer Byte 2 Register (IDER—D22:F2).....	917
23.3.4.8	IDEPBMDTPR3—IDE Primary Bus Master Descriptor Table Pointer Byte 3 Register (IDER—D22:F2).....	917
23.3.4.9	IDESBMCR—IDE Secondary Bus Master Command Register (IDER—D22:F2).....	918
23.3.4.10	IDESBMDS0R—IDE Secondary Bus Master Device Specific 0 Register (IDER—D22:F2).....	918

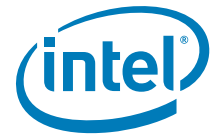

23.3.4.11	IDESBMSR—IDE Secondary Bus Master Status Register (IDER—D22:F2)	919
23.3.4.12	IDESBMDS1R—IDE Secondary Bus Master Device Specific 1 Register (IDER—D22:F2)	919
23.3.4.13	IDESBMDTPR0—IDE Secondary Bus Master Descriptor Table Pointer Byte 0 Register (IDER—D22:F2)	919
23.3.4.14	IDESBMDTPR1—IDE Secondary Bus Master Descriptor Table Pointer Byte 1 Register (IDER—D22:F2)	920
23.3.4.15	IDESBMDTPR2—IDE Secondary Bus Master Descriptor Table Pointer Byte 2 Register (IDER—D22:F2)	920
23.3.4.16	IDESBMDTPR3—IDE Secondary Bus Master Descriptor Table Pointer Byte 3 Register (IDER—D22:F2)	920
23.4	Serial Port for Remote Keyboard and Text (KT) Redirection (KT — D22:F3)	921
23.4.1	PCI Configuration Registers (KT — D22:F3)	921
23.4.1.1	VID—Vendor Identification Register (KT—D22:F3)	922
23.4.1.2	DID—Device Identification Register (KT—D22:F3)	922
23.4.1.3	CMD—Command Register (KT—D22:F3)	922
23.4.1.4	STS—Device Status Register (KT—D22:F3)	923
23.4.1.5	RID—Revision ID Register (KT—D22:F3)	923
23.4.1.6	CC—Class Codes Register (KT—D22:F3)	923
23.4.1.7	CLS—Cache Line Size Register (KT—D22:F3)	924
23.4.1.8	KTIBA—KT IO Block Base Address Register (KT—D22:F3)	924
23.4.1.9	KT MBA—KT Memory Block Base Address Register (KT—D22:F3)	924
23.4.1.10	SVID—Subsystem Vendor ID Register (KT—D22:F3)	925
23.4.1.11	SID—Subsystem ID Register (KT—D22:F3)	925
23.4.1.12	CAP—Capabilities Pointer Register (KT—D22:F3)	925
23.4.1.13	INTR—Interrupt Information Register (KT—D22:F3)	925
23.4.1.14	PID—PCI Power Management Capability ID Register (KT—D22:F3)	926
23.4.1.15	PC—PCI Power Management Capabilities ID Register (KT—D22:F3)	926
23.4.1.16	MID—Message Signaled Interrupt Capability ID Register (KT—D22:F3)	927
23.4.1.17	MC—Message Signaled Interrupt Message Control Register (KT—D22:F3)	927
23.4.1.18	MA—Message Signaled Interrupt Message Address Register (KT—D22:F3)	927
23.4.1.19	MAU—Message Signaled Interrupt Message Upper Address Register (KT—D22:F3)	928
23.4.1.20	MD—Message Signaled Interrupt Message Data Register (KT—D22:F3)	928
23.4.2	KT IO/Memory Mapped Device Registers	928
23.4.2.1	KTRxBR—KT Receive Buffer Register (KT—D22:F3)	929
23.4.2.2	KTTHR—KT Transmit Holding Register (KT—D22:F3)	929
23.4.2.3	KTDLLR—KT Divisor Latch LSB Register (KT—D22:F3)	929
23.4.2.4	KTIER—KT Interrupt Enable Register (KT—D22:F3)	930
23.4.2.5	KTDLMR—KT Divisor Latch MSB Register (KT—D22:F3)	930
23.4.2.6	KTIIR—KT Interrupt Identification Register (KT—D22:F3)	931
23.4.2.7	KTFPCR—KT FIFO Control Register (KT—D22:F3)	931
23.4.2.8	KTLCR—KT Line Control Register (KT—D22:F3)	932
23.4.2.9	KTMCR—KT Modem Control Register (KT—D22:F3)	932
23.4.2.10	KTLR—KT Line Status Register (KT—D22:F3)	933
23.4.2.11	KTMSR—KT Modem Status Register (KT—D22:F3)	934

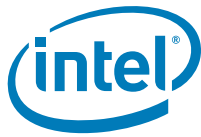

Figures

2-1	PCH Interface Signals Block Diagram (not all signals are on all SKUs).....	56
2-2	Example External RTC Circuit.....	92
4-1	PCH High-Level Clock Diagram.....	115
5-1	Generation of SERR# to Platform	126
5-2	LPC Interface Diagram	136
5-3	PCH DMA Controller.....	141
5-4	DMA Request Assertion through LDRQ#	144
5-5	TCO Legacy/Compatible Mode SMBus Configuration	194
5-6	Advanced TCO Mode.....	195
5-7	Serial Post over GPIO Reference Circuit.....	197
5-8	Flow for Port Enable / Device Present Bits.....	205
5-9	Serial Data transmitted over the SGPIO Interface	209
5-10	EHCI with USB 2.0 with Rate Matching Hub	224
5-11	PCH Intel® Management Engine High-Level Block Diagram	254
5-12	Flash Descriptor Sections	257
5-13	Analog Port Characteristics	266
5-14	LVDS Signals and Swing Voltage	268
5-15	LVDS Clock and Data Relationship	268
5-16	Panel Power Sequencing	269
5-17	HDMI Overview.....	270
5-18	DisplayPort Overview.....	271
5-19	SDVO Conceptual Block Diagram	273
6-1	Desktop PCH Ballout (Top View - Upper Left)	279
6-2	Desktop PCH Ballout (Top View - Lower Left)	280
6-3	Desktop PCH Ballout (Top View - Upper Right)	281
6-4	Desktop PCH Ballout (Top View - Lower Right)	282
6-5	Mobile PCH Ballout (Top View - Upper Left).....	290
6-6	Mobile PCH Ballout (Top View - Lower Left).....	291
6-7	Mobile PCH Ballout (Top View - Upper Right).....	292
6-8	Mobile PCH Ballout (Top View - Lower Right).....	293
6-9	Mobile SFF PCH Package (Top View - Upper Left)	302
6-10	Mobile SFF PCH Package (Top View - Lower Left)	303
6-11	Mobile SFF PCH Package (Top View - Upper Right)	304
6-12	Mobile SFF PCH Package (Top View - Lower Right)	305
7-1	Desktop PCH Package Drawing.....	308
7-2	Mobile PCH Package Drawing	310
7-3	Mobile SFF PCH Package Drawing	312
8-1	G3 w/RTC Loss to S4/S5 (With Deep S4/S5 Support) Timing Diagram	350
8-2	G3 w/RTC Loss to S4/S5 (Without Deep S4/S5 Support) Timing Diagram	350
8-3	S5 to S0 Timing Diagram	351
8-4	S3/M3 to S0 Timing Diagram	352
8-5	S5/Moff - S5/M3 Timing Diagram	352
8-6	S0 to S5 Timing Diagram	353
8-7	S4/S5 to Deep S4/S5 to G3 w/ RTC Loss Timing Diagram	354
8-8	DRAMPWROK Timing Diagram.....	354
8-9	Clock Cycle Time.....	355
8-10	Transmitting Position (Data to Strobe)	355
8-11	Clock Timing.....	355
8-13	Setup and Hold Times.....	356
8-14	Float Delay.....	356
8-15	Pulse Width	356
8-12	Valid Delay from Rising Clock Edge	356
8-16	Output Enable Delay.....	357
8-17	USB Rise and Fall Times	357
8-18	USB Jitter	357
8-19	USB EOP Width	358
8-20	SMBus Transaction	358
8-21	SMBus Timeout.....	358
8-22	SPI Timings.....	359
8-23	Intel® High Definition Audio Input and Output Timings.....	359
8-24	Dual Channel Interface Timings.....	360
8-25	Dual Channel Interface Timings.....	360
8-26	LVDS Load and Transition Times	360
8-27	Transmitting Position (Data to Strobe)	361
8-28	PCI Express Transmitter Eye.....	361

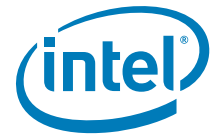

8-29	PCI Express Receiver Eye.....	362
8-30	Measurement Points for Differential Waveforms.....	363
8-31	PCH Test Load.....	364
8-32	Controller Link Receive Timings.....	364
8-33	Controller Link Receive Slew Rate.....	364

Tables

1-1	Industry Specifications.....	42
1-2	Desktop Intel® 6 Series Chipset SKUs.....	51
1-3	Mobile Intel® 6 Series Chipset SKUs.....	52
1-4	Server/Workstation Intel® C200 Series Chipset SKUs.....	53
2-1	Direct Media Interface Signals.....	57
2-2	PCI Express* Signals.....	57
2-3	PCI Interface Signals.....	58
2-4	Serial ATA Interface Signals.....	60
2-5	LPC Interface Signals.....	63
2-6	Interrupt Signals.....	63
2-7	USB Interface Signals.....	64
2-8	Power Management Interface Signals.....	65
2-9	Processor Interface Signals.....	69
2-10	SM Bus Interface Signals.....	69
2-11	System Management Interface Signals.....	69
2-12	Real Time Clock Interface.....	70
2-13	Miscellaneous Signals.....	70
2-14	Intel® High Definition Audio Link Signals.....	72
2-15	Controller Link Signals.....	73
2-16	Serial Peripheral Interface (SPI) Signals.....	73
2-17	Thermal Signals.....	73
2-18	Testability Signals.....	74
2-19	Clock Interface Signals.....	74
2-20	LVDS Interface Signals.....	77
2-21	Analog Display Interface Signals.....	78
2-22	Intel® Flexible Display Interface Signals.....	78
2-23	Digital Display Interface Signals.....	79
2-24	General Purpose I/O Signals.....	82
2-25	Manageability Signals.....	86
2-26	Power and Ground Signals.....	87
2-27	Functional Strap Definitions.....	89
3-1	Integrated Pull-Up and Pull-Down Resistors.....	93
3-2	Power Plane and States for Output and I/O Signals for Desktop Configurations.....	95
3-3	Power Plane and States for Output and I/O Signals for Mobile Configurations.....	101
3-4	Power Plane for Input Signals for Desktop Configurations.....	107
3-5	Power Plane for Input Signals for Mobile Configurations.....	110
4-1	PCH Clock Inputs.....	113
4-2	Clock Outputs.....	114
4-3	PCH PLLs.....	116
4-4	SSC Blocks.....	117
5-1	PCI Bridge Initiator Cycle Types.....	120
5-2	Type 1 Address Format.....	122
5-3	MSI versus PCI IRQ Actions.....	124
5-4	LAN Mode Support.....	131
5-5	LPC Cycle Types Supported.....	137
5-6	Start Field Bit Definitions.....	137
5-7	Cycle Type Bit Definitions.....	138
5-8	Transfer Size Bit Definition.....	138
5-9	SYNC Bit Definition.....	138
5-10	DMA Transfer Size.....	142
5-11	Address Shifting in 16-Bit I/O DMA Transfers.....	143
5-12	Counter Operating Modes.....	148
5-13	Interrupt Controller Core Connections.....	150
5-14	Interrupt Status Registers.....	151
5-15	Content of Interrupt Vector Byte.....	151
5-16	APIC Interrupt Mapping1.....	157
5-17	Stop Frame Explanation.....	160
5-18	Data Frame Format.....	161
5-19	Configuration Bits Reset by RTCRST# Assertion.....	164



5-20	INIT# Going Active.....	166
5-21	NMI Sources.....	167
5-22	General Power States for Systems Using the PCH	168
5-23	State Transition Rules for the PCH	169
5-24	System Power Plane	170
5-25	Causes of SMI and SCI	171
5-26	Sleep Types.....	175
5-27	Causes of Wake Events	176
5-28	GPI Wake Events	177
5-29	Transitions Due to Power Failure	178
5-30	Supported Deep S4/S5 Policy Configurations.....	179
5-31	Deep S4/S5 Wake Events	179
5-32	Transitions Due to Power Button	180
5-33	Transitions Due to RI# Signal	181
5-34	Write Only Registers with Read Paths in ALT Access Mode.....	184
5-35	PIC Reserved Bits Return Values	186
5-36	Register Write Accesses in ALT Access Mode	186
5-37	SLP_LAN# Pin Behavior	188
5-38	Causes of Host and Global Resets.....	190
5-39	Event Transitions that Cause Messages	194
5-40	Multi-activity LED Message Type.....	208
5-41	Legacy Replacement Routing	211
5-42	Debug Port Behavior.....	218
5-43	I ² C Block Read.....	228
5-44	Enable for SMBALERT#	230
5-45	Enables for SMBus Slave Write and SMBus Host Events	231
5-46	Enables for the Host Notify Command	231
5-47	Slave Write Registers.....	233
5-48	Command Types	233
5-49	Slave Read Cycle Format.....	234
5-50	Data Values for Slave Read Registers.....	235
5-51	Host Notify Format	237
5-52	PCH Thermal Throttle States (T-states)	240
5-53	PCH Thermal Throttling Configuration Registers.....	240
5-54	I ² C Write Commands to the Intel® ME	242
5-55	Block Read Command – Byte Definition	243
5-56	Region Size versus Erase Granularity of Flash Components	256
5-57	Region Access Control Table	258
5-58	Hardware Sequencing Commands and Opcode Requirements	261
5-59	Flash Protection Mechanism Summary	263
5-60	Recommended Pinout for 8-Pin Serial Flash Device	264
5-61	Recommended Pinout for 16-Pin Serial Flash Device	264
5-59	PCH Supported Audio Formats over HDMI and DisplayPort*	272
5-60	PCH Digital Port Pin Mapping.....	274
5-61	Display Co-Existence Table	275
6-1	Desktop PCH Ballout By Signal Name	283
6-2	Mobile PCH Ballout By Signal Name	294
8-1	Storage Conditions and Thermal Junction Operating Temperature Limits.....	313
8-2	Mobile Thermal Design Power	314
8-3	PCH Absolute Maximum Ratings	314
8-4	PCH Power Supply Range	315
8-5	Measured I _{CC} (Desktop Only).....	315
8-6	Measured I _{CC} (Mobile Only)	316
8-7	DC Characteristic Input Signal Association	318
8-8	DC Input Characteristics	320
8-9	DC Characteristic Output Signal Association	323
8-10	DC Output Characteristics	325
8-11	Other DC Characteristics	327
8-12	Signal Groups.....	328
8-13	CRT DAC Signal Group DC Characteristics: Functional Operating Range (V _{CC} ADAC = 3.3 V ±5%).....	328
8-14	LVDS Interface: Functional Operating Range (V _{CC} ALVDS = 1.8 V ±5%).....	329
8-15	Display Port Auxiliary Signal Group DC Characteristics.....	329
8-16	PCI Express* Interface Timings.....	330
8-17	HDMI Interface Timings (DDP[D:B][3:0])Timings	331
8-18	SDVO Interface Timings	331
8-19	DisplayPort Interface Timings (DDP[D:B][3:0])	332

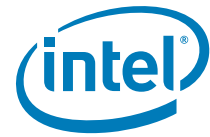

8-20	DisplayPort Aux Interface	333
8-21	DDC Characteristics	333
8-22	LVDS Interface AC Characteristics at Various Frequencies	334
8-23	CRT DAC AC Characteristics	336
8-24	Clock Timings.....	336
8-25	PCI Interface Timing	340
8-26	Universal Serial Bus Timing	341
8-27	SATA Interface Timings	342
8-28	SMBus and SMLink Timing	343
8-29	Intel® High Definition Audio Timing.....	344
8-30	LPC Timing	344
8-31	Miscellaneous Timings	344
8-32	SPI Timings (20 MHz).....	345
8-33	SPI Timings (33 MHz).....	345
8-34	SPI Timings (50 MHz).....	346
8-35	SST Timings (Server/Workstation Only).....	346
8-36	Controller Link Receive Timings	347
8-37	Power Sequencing and Reset Signal Timings.....	347
9-1	PCI Devices and Functions	366
9-2	Fixed I/O Ranges Decoded by PCH	368
9-3	Variable I/O Decode Ranges.....	370
9-4	Memory Decode Ranges from Processor Perspective	371
9-5	SPI Mode Address Swapping	373
10-1	Chipset Configuration Register Memory Map (Memory Space)	375
11-1	PCI Bridge Register Address Map (PCI-PCI—D30:F0)	417
12-1	Gigabit LAN Configuration Registers Address Map (Gigabit LAN —D25:F0)	435
13-1	LPC Interface PCI Register Address Map (LPC I/F—D31:F0)	449
13-2	DMA Registers.....	476
13-3	PIC Registers	486
13-4	APIC Direct Registers	494
13-5	APIC Indirect Registers.....	494
13-6	RTC I/O Registers.....	499
13-7	RTC (Standard) RAM Bank	500
13-8	Processor Interface PCI Register Address Map	504
13-9	Power Management PCI Register Address Map (PM—D31:F0).....	507
13-10	APM Register Map	517
13-11	ACPI and Legacy I/O Register Map	518
13-12	TCO I/O Register Address Map.....	536
13-13	Registers to Control GPIO Address Map.....	543
14-1	SATA Controller PCI Register Address Map (SATA—D31:F2).....	553
14-2	Bus Master IDE I/O Register Address Map	580
14-3	AHCI Register Address Map.....	588
14-4	Generic Host Controller Register Address Map.....	589
14-5	Port [5:0] DMA Register Address Map	599
15-1	SATA Controller PCI Register Address Map (SATA—D31:F5).....	615
15-2	Bus Master IDE I/O Register Address Map	631
16-1	USB EHCI PCI Register Address Map (USB EHCI—D29:F0, D26:F0)	639
16-2	Enhanced Host Controller Capability Registers	662
16-3	Enhanced Host Controller Operational Register Address Map	665
16-4	Debug Port Register Address Map	680
17-1	Intel® High Definition Audio PCI Register Address Map (Intel® High Definition Audio D27:F0)	685
17-2	Intel® High Definition Audio Memory Mapped Configuration Registers Address Map (Intel® High Definition Audio D27:F0).....	707
17-3	Configuration Default	733
17-4	Configuration Data Structure.....	733
17-5	Port Connectivity	735
17-6	Location	735
17-7	Default Device.....	736
17-8	Connection Type.....	736
17-9	Color.....	737
17-10	Misc.....	737
18-1	SMBus Controller PCI Register Address Map (SMBus—D31:F3).....	739
18-2	SMBus I/O and Memory Mapped I/O Register Address Map.....	746
19-1	PCI Express* Configuration Registers Address Map (PCI Express*—D28:F0/F1/F2/F3/F4/F5/F6/F7)	757

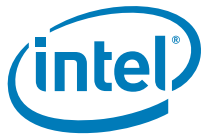

20-1	Memory-Mapped Register Address Map	801
21-1	Serial Peripheral Interface (SPI) Register Address Map (SPI Memory Mapped Configuration Registers)	811
21-2	Gigabit LAN SPI Flash Program Register Address Map (GbE LAN Memory Mapped Configuration Registers).....	835
22-1	Thermal Sensor Register Address Map.....	847
22-2	Thermal Memory Mapped Configuration Register Address Map.....	855
23-1	Intel® MEI 1 Configuration Registers Address Map (Intel® MEI 1—D22:F0)	869
23-2	Intel® MEI 1 MMIO Register Address Map	879
23-3	Intel® MEI 2 Configuration Registers Address Map (Intel® MEI 2—D22:F1)	882
23-4	Intel® MEI 2 MMIO Register Address Map	892
23-5	IDE Redirect Function IDER Register Address Map	895
23-6	IDER BAR0 Register Address Map	903
23-7	IDER BAR1 Register Address Map	913
23-8	IDER BAR4 Register Address Map	914
23-9	Serial Port for Remote Keyboard and Text (KT) Redirection Register Address Map.....	921
23-10	KT IO/Memory Mapped Device Register Address Map	928

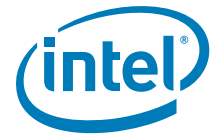

Revision History

Revision	Description	Date
001	<ul style="list-style-type: none"> Initial Release 	January 2011
002	<ul style="list-style-type: none"> Added the Intel Q67, B65, H61, QM67, UM67, and QS67 Chipset Chapter 1 <ul style="list-style-type: none"> Updated Table 1-1 Updated following sub-sections in Section 1.2.1 <ul style="list-style-type: none"> Intel® Active Management Technology (Intel® AMT) SOL Function KVM (new) IDE-R Function Chapter 5 <ul style="list-style-type: none"> Updated Table 5-22, 5-23, and 5-29. Chapter 6 <ul style="list-style-type: none"> Added SFF Top View Ballout figures in Section 6.3. Chapter 8 <ul style="list-style-type: none"> Updated Table 8-1 to add Tj for Mobile. Chapter 9 <ul style="list-style-type: none"> Updated Table 9-3, Variable I/O Decode Ranges Chapter 10 <ul style="list-style-type: none"> Updated Section 10.1.54, DEEP_S4_POL—Deep S4/S5 From S4 Power Policies Updated Section 10.1.55, DEEP_S5_POL—Deep S4/S5 From S5 Power Policies Updated Bits 29:28 in Section 10.1.78, CG—Clock Gating Chapter 13 <ul style="list-style-type: none"> Updated Section 13.8.1.8, PMIR—Power Management Initialization Register (PM—D31:F0) Chapter 17 <ul style="list-style-type: none"> Added Section 17.1.1.20, HDINIT1—Intel® High Definition Audio Initialization Register 1 (Intel® High Definition Audio Controller—D27:F0) Chapter 23 <ul style="list-style-type: none"> Added Section 23.1.2, MEI0_MBAR—Intel® MEI 1 MMIO Registers Updated Section 23.2.2.2, CG—Clock Gating 	February 2011
003	<ul style="list-style-type: none"> Added Intel Q65 Chipset 	April 2011
004	<ul style="list-style-type: none"> Added Intel C200 Series Chipset 	April 2011
005	<ul style="list-style-type: none"> Added Intel Z68 Series Chipset Minor updates throughout for clarity 	May 2011
006	<ul style="list-style-type: none"> Minor updates for clarity 	May 2011



Platform Controller Hub Features

- Direct Media Interface
 - NEW: Up to 20 Gb/s each direction, full duplex
 - Transparent to software
- PCI Express*
 - Up to eight PCI Express root ports
 - NEW: Supports PCI Express Rev 2.0 running at up to 5.0 GT/s
 - Ports 1-4 and 5-8 can independently be configured to support eight x1s, two x4s, two x2s and four x1s, or one x4 and four x1 port widths
 - Module based Hot-Plug supported (that is, ExpressCard*)
- Integrated Serial ATA Host Controller
 - Up to six SATA ports
 - NEW: Data transfer rates up to 6.0 Gb/s (600 MB/s) on up to two ports
 - Data transfer rates up to 3.0 Gb/s (300 MB/s) and up to 1.5 Gb/s (150 MB/s) on all ports
 - Integrated AHCI controller
- External SATA support on all ports
 - 3.0 Gb/s / 1.5 Gb/s support
 - Port Disable Capability
- Intel® Rapid Storage Technology
 - Configures the PCH SATA controller as a RAID controller supporting RAID 0/1/5/10
- NEW: Intel® Smart Response Technology
- Intel® High Definition Audio Interface
 - PCI Express endpoint
 - Independent Bus Master logic for eight general purpose streams: four input and four output
 - Support four external Codex
 - Supports variable length stream slots
 - Supports multichannel, 32-bit sample depth, 192 kHz sample rate output
 - Provides mic array support
 - Allows for non-48 kHz sampling output
 - Support for ACPI Device States
 - Low Voltage
- Eight TACH signals and Four PWM signals (Server and Workstation Only)
- Platform Environmental Control Interface (PECI) and Simple Serial Transport (SST) 1.0 Bus (Server and Workstation Only)
- USB
 - Two EHCI Host Controllers, supporting up to fourteen external USB 2.0 ports
 - Two USB 2.0 Rate Matching Hubs
 - Per-Port-Disable Capability
 - Includes up to two USB 2.0 High-speed Debug Ports
 - Supports wake-up from sleeping states S1-S4
 - Supports legacy Keyboard/Mouse software
- Integrated Gigabit LAN Controller
 - Connection utilizes PCI Express pins
 - Integrated ASF Management Controller
 - Network security with System Defense
 - Supports IEEE 802.3
 - 10/100/1000 Mbps Ethernet Support
 - Jumbo Frame Support
- Intel® Active Management Technology with System Defense
 - Network Outbreak Containment Heuristics
- Intel® I/O Virtualization (Intel® VT-d) Support
- Intel® Trusted Execution Technology Support
- Intel® Anti-Theft Technology
- Power Management Logic
 - Supports ACPI 4.0a
 - ACPI-defined power states (processor driven C states)
 - ACPI Power Management Timer
 - SMI# generation
 - All registers readable/restorable for proper resume from 0 V core well suspend states
 - Support for APM-based legacy power management for non-ACPI implementations
- Integrated Clock Controller
 - Full featured platform clocking without need for a discrete clock chip
 - Ten PCIe 2.0 specification compliant clocks, four 33 MHz PCI clocks, four Flex Clocks that can be configured for various crystal replacement frequencies, one 120 MHz clock for embedded DisplayPort*
 - Two isolated PCIe* 2.0 jitter specification compliant clock domains

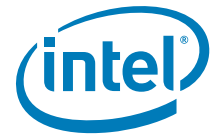

- External Glue Integration
 - Integrated Pull-down and Series resistors on USB
- Enhanced DMA Controller
 - Two cascaded 8237 DMA controllers
 - Supports LPC DMA
- PCI Bus Interface (not available on all SKUs)
 - Supports PCI Rev 2.3 Specification at 33 MHz
 - Four available PCI REQ/GNT pairs
 - Support for 64-bit addressing on PCI using DAC protocol
- SMBus
 - Interface speeds of up to 100 kbps
 - Flexible SMBus/SMLink architecture to optimize for ASF
 - Provides independent manageability bus through SMLink interface
 - Supports SMBus 2.0 Specification
 - Host interface allows processor to communicate using SMBus
 - Slave interface allows an internal or external microcontroller to access system resources
 - Compatible with most two-wire components that are also I²C compatible
- High Precision Event Timers
 - Advanced operating system interrupt scheduling
- Timers Based on 82C54
 - System timer, Refresh request, Speaker tone output
- Real-Time Clock
 - 256 byte battery-backed CMOS RAM
 - Integrated oscillator components
 - Lower Power DC/DC Converter implementation
- System TCO Reduction Circuits
 - Timers to generate SMI# and Reset upon detection of system hang
 - Timers to detect improper processor reset
 - Supports ability to disable external devices
- JTAG
 - Boundary Scan for testing during board manufacturing
- Serial Peripheral Interface (SPI)
 - Supports up to two SPI devices
 - Supports 20 MHz, 33 MHz, and 50 MHz SPI devices
 - Support up to two different erase granularities
- Firmware Hub I/F supports BIOS Memory size up to 8 MB
- Low Pin Count (LPC) I/F
 - Supports two Master/DMA devices.
 - Support for Security Device (Trusted Platform Module) connected to LPC
- Interrupt Controller
 - Supports up to eight PCI interrupt pins
 - Supports PCI 2.3 Message Signaled Interrupts
 - Two cascaded 82C59 with 15 interrupts
 - Integrated I/O APIC capability with 24 interrupts
 - Supports Processor System Bus interrupt delivery
- 1.05 V operation with 1.5/3.3 V I/O
 - 5 V tolerant buffers on PCI, USB and selected Legacy signals
- 1.05 V Core Voltage
- Integrated Voltage Regulators for select power rails
- GPIO
 - Open-Drain, Inversion
 - GPIO lock down
- Analog Display (VGA)
- Digital Display
 - Three Digital Ports capable of supporting HDMI/DVI, DisplayPort*, and embedded DisplayPort (eDP*)
 - One Digital Port supporting SDVO
 - LVDS
 - Integrated DisplayPort/HDMI Audio
 - HDCP Support
- Package
 - 27 mm x 27 mm FCBGA (Desktop Only)
 - 25 mm x 25 mm FCBGA (Mobile Only)
 - 22 mm x 22 mm FCBGA (Mobile SFF Only)

Note: Not all features are available on all PCH SKUs. See [Section 1.3](#) for more details.







1 Introduction

1.1 About This Manual

This document is intended for Original Equipment Manufacturers and BIOS vendors creating Intel® 6 Series Chipset and Intel® C200 Series Chipset based products (See [Section 1.3](#) for currently defined SKUs).

Note: Throughout this document, Platform Controller Hub (PCH) is used as a general term and refers to all Intel 6 Series Chipset and Intel C200 Series Chipset SKUs, unless specifically noted otherwise.

Note: Throughout this document, the terms “Desktop” and “Desktop Only” refer to information that is applicable only to the Intel® Q67 Chipset, Intel® Q65 Chipset, Intel® B65 Chipset, Intel® Z68 Chipset, Intel® H67 Chipset, Intel® P67 Chipset, Intel® H61 Chipset, Intel® C202 Chipset, Intel® C204 Chipset, and Intel® C206 Chipset, unless specifically noted otherwise.

Note: Throughout this document, the terms “Server/Workstation” and “Server/Workstation Only” refers to information that is applicable only to the Intel® C202 Chipset, Intel® C204 Chipset, and Intel® C206 Chipset, unless specifically noted otherwise.

Note: Throughout this document, the terms “Mobile” and “Mobile Only” refers to information that is applicable only to the Intel® QM67 Chipset, Intel® UM67 Chipset, Intel® HM67 Chipset, Intel® HM65 Chipset, and Intel® QS67 Chipset, unless specifically noted otherwise.

Note: Throughout this document, the terms “Small Form Factor Only” and “SFF Only” refers to information that is applicable only to the Intel® QS67 Chipset, unless specifically noted otherwise.

This manual assumes a working knowledge of the vocabulary and principles of PCI Express*, USB, AHCI, SATA, Intel® High Definition Audio (Intel® HD Audio), SMBus, PCI, ACPI and LPC. Although some details of these features are described within this manual, refer to the individual industry specifications listed in [Table 1-1](#) for the complete details.

All PCI buses, devices and functions in this manual are abbreviated using the following nomenclature; Bus:Device:Function. This manual abbreviates buses as B_n , devices as D_n and functions as F_n . For example Device 31 Function 0 is abbreviated as D31:F0, Bus 1 Device 8 Function 0 is abbreviated as B1:D8:F0. Generally, the bus number will not be used, and can be considered to be Bus 0. Note that the PCH’s external PCI bus is typically Bus 1, but may be assigned a different number depending upon system configuration.

Table 1-1. Industry Specifications

Specification	Location
<i>PCI Express* Base Specification, Revision 2.0</i>	http://www.pcisig.com/specifications
<i>Low Pin Count Interface Specification, Revision 1.1 (LPC)</i>	http://developer.intel.com/design/chipsets/industry/lpc.htm
<i>System Management Bus Specification, Version 2.0 (SMBus)</i>	http://www.smbus.org/specs/
<i>PCI Local Bus Specification, Revision 2.3 (PCI)</i>	http://www.pcisig.com/specifications
<i>PCI Power Management Specification, Revision 1.2</i>	http://www.pcisig.com/specifications
<i>Universal Serial Bus Specification (USB), Revision 2.0</i>	http://www.usb.org/developers/docs
<i>Advanced Configuration and Power Interface, Version 4.0a (ACPI)</i>	http://www.acpi.info/spec.htm
<i>Enhanced Host Controller Interface Specification for Universal Serial Bus, Revision 1.0 (EHCI)</i>	http://developer.intel.com/technology/usb/ehcispec.htm
<i>Serial ATA Specification, Revision 3.0</i>	http://www.serialata.org/
<i>Serial ATA II: Extensions to Serial ATA 1.0, Revision 1.0</i>	http://www.serialata.org
<i>Serial ATA II Cables and Connectors Volume 2 Gold</i>	http://www.serialata.org
<i>Alert Standard Format Specification, Version 1.03</i>	http://www.dmtf.org/standards/asf
<i>IEEE 802.3 Fast Ethernet</i>	http://standards.ieee.org/getieee802/
<i>AT Attachment - 6 with Packet Interface (ATA/ATAPI - 6)</i>	http://T13.org (T13 1410D)
<i>IA-PC HPET (High Precision Event Timers) Specification, Revision 1.0a</i>	http://www.intel.com/hardwaredesign/hpetspec_1.pdf
<i>TPM Specification 1.02, Level 2 Revision 103</i>	http://www.trustedcomputinggroup.org/specs/TPM
<i>Intel® Virtualization Technology</i>	http://www.intel.com/technology/virtualization/index.htm
<i>SFF-8485 Specification for Serial GPIO (SGPIO) Bus, Revision 0.7</i>	http://www.intel.com/technology/virtualization/index.htm
<i>Advanced Host Controller Interface specification for Serial ATA, Revision 1.3</i>	http://www.intel.com/technology/serialata/ahci.htm
<i>Intel® High Definition Audio Specification, Revision 1.0a</i>	http://www.intel.com/standards/hdaudio/

Chapter 1, "Introduction"

Chapter 1 introduces the PCH and provides information on manual organization and gives a general overview of the PCH.

Chapter 2, "Signal Description"

Chapter 2 provides a block diagram of the PCH and a detailed description of each signal. Signals are arranged according to interface and details are provided as to the drive characteristics (Input/Output, Open Drain, etc.) of all signals.

Chapter 3, "PCH Pin States"

Chapter 3 provides a complete list of signals, their associated power well, their logic level in each suspend state, and their logic level before and after reset.

Chapter 4, "PCH and System Clocks"

Chapter 4 provides a list of each clock domain associated with the PCH.

**Chapter 5, “Functional Description”**

Chapter 5 provides a detailed description of the functions in the PCH.

Chapter 6, “Ballout Definition”

Chapter 6 provides the ball assignment table and the ball-map for the Desktop, Mobile and Mobile SFF packages.

Chapter 7, “Package Information”

Chapter 7 provides drawings of the physical dimensions and characteristics of the Desktop, Mobile and Mobile SFF packages.

Chapter 8, “Electrical Characteristics”

Chapter 8 provides all AC and DC characteristics including detailed timing diagrams.

Chapter 9, “Register and Memory Mapping”

Chapter 9 provides an overview of the registers, fixed I/O ranges, variable I/O ranges and memory ranges decoded by the PCH.

Chapter 10, “Chipset Configuration Registers”

Chapter 10 provides a detailed description of registers and base functionality that is related to chipset configuration. It contains the root complex register block, which describes the behavior of the upstream internal link.

Chapter 11, “PCI-to-PCI Bridge Registers (D30:F0)”

Chapter 11 provides a detailed description of registers that reside in the PCI-to-PCI bridge. This bridge resides at Device 30, Function 0 (D30:F0).

Chapter 12, “Gigabit LAN Configuration Registers”

Chapter 12 provides a detailed description of registers that reside in the PCH’s integrated LAN controller. The integrated LAN Controller resides at Device 25, Function 0 (D25:F0).

Chapter 13, “LPC Interface Bridge Registers (D31:F0)”

Chapter 13 provides a detailed description of registers that reside in the LPC bridge. This bridge resides at Device 31, Function 0 (D31:F0). This function contains registers for many different units within the PCH including DMA, Timers, Interrupts, Processor Interface, GPIO, Power Management, System Management and RTC.

Chapter 14, “SATA Controller Registers (D31:F2)”

Chapter 14 provides a detailed description of registers that reside in the SATA controller #1. This controller resides at Device 31, Function 2 (D31:F2).

Chapter 15, “SATA Controller Registers (D31:F5)”

Chapter 15 provides a detailed description of registers that reside in the SATA controller #2. This controller resides at Device 31, Function 5 (D31:F5).

Chapter 16, “EHCI Controller Registers (D29:F0, D26:F0)”

Chapter 16 provides a detailed description of registers that reside in the two EHCI host controllers. These controllers reside at Device 29, Function 0 (D29:F0) and Device 26, Function 0 (D26:F0).

Chapter 17, “Integrated Intel® High Definition Audio Controller Registers”

Chapter 17 provides a detailed description of registers that reside in the Intel High Definition Audio controller. This controller resides at Device 27, Function 0 (D27:F0).

Chapter 18, “SMBus Controller Registers (D31:F3)”

Chapter 18 provides a detailed description of registers that reside in the SMBus controller. This controller resides at Device 31, Function 3 (D31:F3).

Chapter 19, “PCI Express* Configuration Registers”

Chapter 19 provides a detailed description of registers that reside in the PCI Express controller. This controller resides at Device 28, Functions 0 to 7 (D28:F0-F7).

Chapter 20, “High Precision Event Timer Registers”

Chapter 20 provides a detailed description of registers that reside in the multimedia timer memory mapped register space.

Chapter 21, “Serial Peripheral Interface (SPI)”

Chapter 21 provides a detailed description of registers that reside in the SPI memory mapped register space.

Chapter 22, “Thermal Sensor Registers (D31:F6)”

Chapter 22 provides a detailed description of registers that reside in the thermal sensors PCI configuration space. The registers reside at Device 31, Function 6 (D31:F6).

Chapter 23, “Intel® Management Engine Subsystem Registers (D22:F[3:0])”

Chapter 23 provides a detailed description of registers that reside in the Intel ME controller. The registers reside at Device 22, Function 0 (D22:F0).

1.2 Overview

The PCH provides extensive I/O support. Functions and capabilities include:

- *PCI Express* Base Specification*, Revision 2.0 support for up to eight ports with transfers up to 5 GT/s
- *PCI Local Bus Specification*, Revision 2.3 support for 33 MHz PCI operations (supports up to four Req/Gnt pairs)
- ACPI Power Management Logic Support, Revision 4.0a
- Enhanced DMA controller, interrupt controller, and timer functions
- Integrated Serial ATA host controllers with independent DMA operation on up to six ports
- USB host interface with two EHCI high-speed USB 2.0 Host controllers and two rate matching hubs provide support for up to fourteen USB 2.0 ports
- Integrated 10/100/1000 Gigabit Ethernet MAC with System Defense
- *System Management Bus (SMBus) Specification*, Version 2.0 with additional support for I²C devices
- Supports Intel® High Definition Audio (Intel® HD Audio)
- Supports Intel® Rapid Storage Technology (Intel® RST)
- Supports Intel® Active Management Technology (Intel® AMT)
- Supports Intel® Virtualization Technology for Directed I/O (Intel® VT-d)
- Supports Intel® Trusted Execution Technology (Intel® TXT)
- Integrated Clock Controller
- Intel® Flexible Display Interconnect (Intel® FDI)
- Analog and digital display ports
 - Analog VGA
 - HDMI
 - DVI
 - DisplayPort* 1.1, Embedded DisplayPort
 - SDVO
 - LVDS (Mobile Only)
- Low Pin Count (LPC) interface
- Firmware Hub (FWH) interface support



- Serial Peripheral Interface (SPI) support
- Intel® Anti-Theft Technology (Intel® AT)
- JTAG Boundary Scan support

The PCH incorporates a variety of PCI devices and functions separated into logical devices, as shown in [Table 9-1](#).

Note: Not all functions and capabilities may be available on all SKUs. Please see [Section 1.3](#) for details on SKU feature availability.

1.2.1 Capability Overview

The following sub-sections provide an overview of the PCH capabilities.

Direct Media Interface (DMI)

Direct Media Interface (DMI) is the chip-to-chip connection between the processor and PCH. This high-speed interface integrates advanced priority-based servicing allowing for concurrent traffic and true isochronous transfer capabilities. Base functionality is completely software-transparent, permitting current and legacy software to operate normally.

Intel® Flexible Display Interconnect (FDI)

Intel® FDI connects the display engine in the processor with the display interfaces on the PCH. The display data from the frame buffer is processed by the display engine and sent to the PCH where it is transcoded and driven out on the panel. Intel FDI involves two channels – A and B for display data transfer.

Intel FDI Channel A has 4 lanes and Channel B supports 4 lanes depending on the display configuration. Each of the Intel FDI Channel lanes uses differential signal supporting 2.7 Gb/s. For two display configurations Intel FDI CH A maps to display pipe A while Intel CH B maps to the second display pipe B.

PCH Display Interface

The PCH integrates latest display technologies such as HDMI*, DisplayPort*, Embedded DisplayPort (eDP*), SDVO, and DVI along with legacy display technologies—Analog Port (VGA) and LVDS (mobile only). The Analog Port and LVDS Port are dedicated ports on the PCH and the Digital Ports B, C, and D can be configured to drive HDMI, DVI, or DisplayPort. Digital Port B can also be configured as SDVO while Digital Port D can be configured as eDP. The HDMI interface supports the HDMI* 1.4a specification while the DisplayPort interface supports the DisplayPort* 1.1a specification. The PCH supports High-bandwidth Digital Content Protection for high definition content playback over digital interfaces. The PCH also integrates audio codecs for audio support over HDMI and DisplayPort interfaces.

The PCH receives the display data over Intel FDI and transcodes the data as per the display technology protocol and sends the data through the display interface.

PCI Express* Interface

The PCH provides up to 8 PCI Express Root Ports, supporting the *PCI Express Base Specification*, Revision 2.0. Each Root Port x1 lane supports up to 5 Gb/s bandwidth in each direction (10 Gb/s concurrent). PCI Express Root Ports 1-4 or Ports 5-8 can independently be configured to support four x1s, two x2s, one x2 and two x1s, or one x4 port widths. Please see [Section 1.3](#) for details on SKU feature availability.

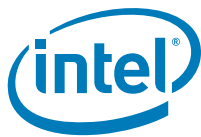

Serial ATA (SATA) Controller

The PCH has two integrated SATA host controllers that support independent DMA operation on up to six ports and supports data transfer rates of up to 6.0 Gb/s (600 MB/s) on up to two ports while all ports support rates up to 3.0 Gb/s (300 MB/s) and up to 1.5 Gb/s (150 MB/s). The SATA controller contains two modes of operation—a legacy mode using I/O space, and an AHCI mode using memory space. Software that uses legacy mode will not have AHCI capabilities.

The PCH supports the Serial ATA Specification, Revision 3.0. The PCH also supports several optional sections of the Serial ATA II: Extensions to Serial ATA 1.0 Specification, Revision 1.0 (AHCI support is required for some elements). Please see [Section 1.3](#) for details on SKU feature availability.

AHCI

The PCH provides hardware support for Advanced Host Controller Interface (AHCI), a standardized programming interface for SATA host controllers. Platforms supporting AHCI may take advantage of performance features such as no master/slave designation for SATA devices—each device is treated as a master—and hardware-assisted native command queuing. AHCI also provides usability enhancements such as Hot-Plug. AHCI requires appropriate software support (such as, an AHCI driver) and for some features, hardware support in the SATA device or additional platform hardware. Please see [Section 1.3](#) for details on SKU feature availability.

Intel® Rapid Storage Technology

The PCH provides support for Intel Rapid Storage Technology, providing both AHCI (see above for details on AHCI) and integrated RAID functionality. The RAID capability provides high-performance RAID 0, 1, 5, and 10 functionality on up to 6 SATA ports of the PCH. Matrix RAID support is provided to allow multiple RAID levels to be combined on a single set of hard drives, such as RAID 0 and RAID 1 on two disks. Other RAID features include hot spare support, SMART alerting, and RAID 0 auto replace. Software components include an Option ROM for pre-boot configuration and boot functionality, a Microsoft Windows* compatible driver, and a user interface for configuration and management of the RAID capability of PCH. See [Section 1.3](#) for details on SKU feature availability.

Intel® Smart Response Technology

Intel® Smart Response Technology is a disk caching solution that can provide improved computer system performance with improved power savings. It allows configuration of a computer systems with the advantage of having HDDs for maximum storage capacity with system performance at or near SSD performance levels. See [Section 1.3](#) for details on SKU feature availability.

PCI Interface

The PCH PCI interface provides a 33 MHz, Revision 2.3 implementation. The PCH integrates a PCI arbiter that supports up to four external PCI bus masters in addition to the internal PCH requests. This allows for combinations of up to four PCI down devices and PCI slots. See [Section 1.3](#) for details on SKU feature availability.

Low Pin Count (LPC) Interface

The PCH implements an LPC Interface as described in the *LPC 1.1 Specification*. The Low Pin Count (LPC) bridge function of the PCH resides in PCI Device 31:Function 0. In addition to the LPC bridge interface function, D31:F0 contains other functional units including DMA, interrupt controllers, timers, power management, system management, GPIO, and RTC.



Serial Peripheral Interface (SPI)

The PCH implements an SPI Interface as an alternative interface for the BIOS flash device. An SPI flash device can be used as a replacement for the FWH, and is required to support Gigabit Ethernet and Intel Active Management Technology. The PCH supports up to two SPI flash devices with speeds up to 50 MHz, using two chip select pins.

Compatibility Modules (DMA Controller, Timer/Counters, Interrupt Controller)

The DMA controller incorporates the logic of two 82C37 DMA controllers, with seven independently programmable channels. Channels 0–3 are hardwired to 8-bit, count-by-byte transfers, and channels 5–7 are hardwired to 16-bit, count-by-word transfers. Any two of the seven DMA channels can be programmed to support fast Type-F transfers. Channel 4 is reserved as a generic bus master request.

The PCH supports LPC DMA, which is similar to ISA DMA, through the PCH's DMA controller. LPC DMA is handled through the use of the LDRQ# lines from peripherals and special encoding on LAD[3:0] from the host. Single, Demand, Verify, and Increment modes are supported on the LPC interface.

The timer/counter block contains three counters that are equivalent in function to those found in one 82C54 programmable interval timer. These three counters are combined to provide the system timer function, and speaker tone. The 14.31818-MHz oscillator input provides the clock source for these three counters.

The PCH provides an ISA-Compatible Programmable Interrupt Controller (PIC) that incorporates the functionality of two, 82C59 interrupt controllers. The two interrupt controllers are cascaded so that 14 external and two internal interrupts are possible. In addition, the PCH supports a serial interrupt scheme.

All of the registers in these modules can be read and restored. This is required to save and restore system state after power has been removed and restored to the platform.

Advanced Programmable Interrupt Controller (APIC)

In addition to the standard ISA compatible Programmable Interrupt controller (PIC) described in the previous section, the PCH incorporates the Advanced Programmable Interrupt Controller (APIC).

Universal Serial Bus (USB) Controllers

The PCH contains up to two Enhanced Host Controller Interface (EHCI) host controllers that support USB high-speed signaling. High-speed USB 2.0 allows data transfers up to 480 Mb/s which is up to 40 times faster than full-speed USB. The PCH supports up to fourteen USB 2.0 ports. All ports are high-speed, full-speed, and low-speed capable. Please see [Section 1.3](#) for details on SKU feature availability.

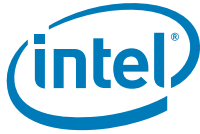

Gigabit Ethernet Controller

The Gigabit Ethernet Controller provides a system interface using a PCI function. The controller provides a full memory-mapped or IO mapped interface along with a 64 bit address master support for systems using more than 4 GB of physical memory and DMA (Direct Memory Addressing) mechanisms for high performance data transfers. Its bus master capabilities enable the component to process high-level commands and perform multiple operations; this lowers processor utilization by off-loading communication tasks from the processor. Two large configurable transmit and receive FIFOs (up to 20 KB each) help prevent data underruns and overruns while waiting for bus accesses. This enables the integrated LAN controller to transmit data with minimum interframe spacing (IFS).

The LAN controller can operate at multiple speeds (10/100/1000 MB/s) and in either full duplex or half duplex mode. In full duplex mode the LAN controller adheres with the *IEEE 802.3x Flow Control Specification*. Half duplex performance is enhanced by a proprietary collision reduction mechanism. See [Section 5.3](#) for details.

RTC

The PCH contains a Motorola MC146818B-compatible real-time clock with 256 bytes of battery-backed RAM. The real-time clock performs two key functions—keeping track of the time of day and storing system data, even when the system is powered down. The RTC operates on a 32.768 KHz crystal and a 3 V battery.

The RTC also supports two lockable memory ranges. By setting bits in the configuration space, two 8-byte ranges can be locked to read and write accesses. This prevents unauthorized reading of passwords or other system security information.

The RTC also supports a date alarm that allows for scheduling a wake up event up to 30 days in advance, rather than just 24 hours in advance.

GPIO

Various general purpose inputs and outputs are provided for custom system design. The number of inputs and outputs varies depending on PCH configuration.

Enhanced Power Management

The PCH's power management functions include enhanced clock control and various low-power (suspend) states (such as Suspend-to-RAM and Suspend-to-Disk). A hardware-based thermal management circuit permits software-independent entrance to low-power states. The PCH contains full support for the *Advanced Configuration and Power Interface (ACPI) Specification, Revision 4.0a*.

Intel® Active Management Technology (Intel® AMT)

Intel AMT is a fundamental component of Intel® vPro™ technology. Intel AMT is a set of advanced manageability features developed as a direct result of IT customer feedback gained through Intel market research. With the advent of powerful tools like the Intel® System Defense Utility, the extensive feature set of Intel AMT easily integrates into any network environment. Please see [Section 1.3](#) for details on SKU feature availability.



Manageability

In addition to Intel AMT the PCH integrates several functions designed to manage the system and lower the total cost of ownership (TCO) of the system. These system management functions are designed to report errors, diagnose the system, and recover from system lockups without the aid of an external microcontroller.

- **TCO Timer.** The PCH's integrated programmable TCO timer is used to detect system locks. The first expiration of the timer generates an SMI# that the system can use to recover from a software lock. The second expiration of the timer causes a system reset to recover from a hardware lock.
- **Processor Present Indicator.** The PCH looks for the processor to fetch the first instruction after reset. If the processor does not fetch the first instruction, the PCH will reboot the system.
- **ECC Error Reporting.** When detecting an ECC error, the host controller has the ability to send one of several messages to the PCH. The host controller can instruct the PCH to generate either an SMI#, NMI, SERR#, or TCO interrupt.
- **Function Disable.** The PCH provides the ability to disable the following integrated functions: LAN, USB, LPC, Intel HD Audio, SATA, PCI Express or SMBus. Once disabled, these functions no longer decode I/O, memory, or PCI configuration space. Also, no interrupts or power management events are generated from the disabled functions.
- **Intruder Detect.** The PCH provides an input signal (INTRUDER#) that can be attached to a switch that is activated by the system case being opened. The PCH can be programmed to generate an SMI# or TCO interrupt due to an active INTRUDER# signal.

System Management Bus (SMBus 2.0)

The PCH contains an SMBus Host interface that allows the processor to communicate with SMBus slaves. This interface is compatible with most I²C devices. Special I²C commands are implemented.

The PCH's SMBus host controller provides a mechanism for the processor to initiate communications with SMBus peripherals (slaves). Also, the PCH supports slave functionality, including the Host Notify protocol. Hence, the host controller supports eight command protocols of the SMBus interface (see *System Management Bus (SMBus) Specification, Version 2.0*): Quick Command, Send Byte, Receive Byte, Write Byte/Word, Read Byte/Word, Process Call, Block Read/Write, and Host Notify.

The PCH's SMBus also implements hardware-based Packet Error Checking for data robustness and the Address Resolution Protocol (ARP) to dynamically provide address to all SMBus devices.

Intel® High Definition Audio Controller

The Intel® *High Definition Audio Specification* defines a digital interface that can be used to attach different types of codecs, such as audio and modem codecs. The PCH Intel® HD Audio controller supports up to 4 codecs. The link can operate at either 3.3 V or 1.5 V.

With the support of multi-channel audio stream, 32-bit sample depth, and sample rate up to 192 kHz, the Intel HD Audio controller provides audio quality that can deliver CE levels of audio experience. On the input side, the PCH adds support for an array of microphones.



Intel® Virtualization Technology for Directed I/O (Intel VT-d)

The PCH provides hardware support for implementation of Intel Virtualization Technology with Directed I/O (Intel® VT-d). Intel VT-d Technology consists of technology components that support the virtualization of platforms based on Intel® Architecture processors. Intel VT-d technology enables multiple operating systems and applications to run in independent partitions. A partition behaves like a virtual machine (VM) and provides isolation and protection across partitions. Each partition is allocated its own subset of host physical memory.

JTAG Boundary-Scan

The PCH implements the industry standard JTAG interface and enables Boundary-Scan in place of the XOR chains used in previous generations of chipsets. Boundary-Scan can be used to ensure device connectivity during the board manufacturing process. The JTAG interface allows system manufacturers to improve efficiency by using industry available tools to test the PCH on an assembled board. Since JTAG is a serial interface, it eliminates the need to create probe points for every pin in an XOR chain. This eases pin breakout and trace routing and simplifies the interface between the system and a bed-of-nails tester.

Note: Contact your local Intel Field Sales Representative for additional information about JTAG usage on the PCH.

Integrated Clock Controller

The PCH contains a Fully Integrated Clock Controller (ICC) generating various platform clocks from a 25 MHz crystal source. The ICC contains up to eight PLLs and four Spread Modulators for generating various clocks suited to the platform needs. The ICC supplies up to ten 100 MHz PCI Express 2.0 Specification compliant clocks, one 100 MHz BCLK/DMI to the processor, one 120 MHz for embedded DisplayPort on the processor, four 33 MHz clocks for SIO/EC/LPC/TPM devices and four Flex Clocks that can be configured to various frequencies that include 14.318 MHz, 27 MHz, 33 MHz and 24/48 MHz for use with SIO, EC, LPC, and discrete Graphics devices.

SOL Function

This function supports redirection of keyboard and text screens to a terminal window on a remote console. The keyboard and text redirection enables the control of the client machine through the network without the need to be physically near that machine. Text and keyboard redirection allows the remote machine to control and configure a client system. The SOL function emulates a standard PCI device and redirects the data from the serial port to the management console using the integrated LAN.

KVM

KVM provides enhanced capabilities to its predecessor – SOL. In addition to the features set provided by SOL, KVM provides mouse and graphic redirection across the integrated LAN. Unlike SOL, KVM does not appear as a host accessible PCI device but is instead almost completely performed by Intel AMT Firmware with minimal BIOS interaction. The KVM feature is only available with internal graphics.



IDE-R Function

The IDE-R function is an IDE Redirection interface that provides client connection to management console ATA/ATAPI devices such as hard disk drives and optical disk drives. A remote machine can setup a diagnostic SW or OS installation image and direct the client to boot an IDE-R session. The IDE-R interface is the same as the IDE interface although the device is not physically connected to the system and supports the ATA/ATAPI-6 specification. IDE-R does not conflict with any other type of boot and can instead be implemented as a boot device option. The Intel AMT solution will use IDE-R when remote boot is required. The device attached through IDE-R is only visible to software during a management boot session. During normal boot session, the IDE-R controller does not appear as a PCI present device.

1.3 Intel® 6 Series Chipset and Intel® C200 Series Chipset SKU Definition

Table 1-2. Desktop Intel® 6 Series Chipset SKUs

Feature Set		SKU Name						
		Q67	Q65	B65	Z68	H67	P67	H61
PCI Express* 2.0 Ports		8	8	8	8	8	8	6 ⁹
PCI Interface		Yes	Yes	Yes	No ¹⁰	No ¹⁰	No ¹⁰	No ¹⁰
USB 2.0 Ports		14	14	12 ⁶	14	14	14	10 ⁷
Total number of SATA ports		6	6	6	6	6	6	4
• SATA Ports (6 Gb/s, 3 Gb/s, and 1.5 Gb/s)		2 ⁴	1 ⁵	1 ⁵	2 ⁴	2 ⁴	2 ⁴	0
• SATA Ports (3 Gb/s and 1.5 Gb/s only)		4	5	5	4	4	4	4 ⁸
HDMI/DVI/VGA/DisplayPort*/eDP*		Yes	Yes	Yes	Yes	Yes	No	Yes
Integrated Graphics Support with PAVP		Yes	Yes	Yes	Yes	Yes	No	Yes
Intel® Rapid Storage Technology	AHCI	Yes	Yes	Yes	Yes	Yes	Yes	No ³
	RAID 0/1/5/10 Support	Yes	No	No	Yes	Yes	Yes	No
	Intel RST SSD Caching ¹¹	No	No	No	Yes	No	No	No
Intel® AT		Yes	Yes	No	No	No	No	No
Intel® AMT 7.0		Yes	No	No	No	No	No	No

NOTES:

- Contact your local Intel Field Sales Representative for currently available PCH SKUs.
- Table above shows feature differences between the PCH SKUs. If a feature is not listed in the table it is considered a Base feature that is included in all SKUs
- The PCH provides hardware support for AHCI functionality when enabled by appropriate system configurations and software drivers.
- SATA 6 Gb/s support on port 0 and port 1. SATA ports 0 and 1 also support 3 Gb/s and 1.5 Gb/s.
- SATA 6 Gb/s support on port 0 only. SATA port 0 also supports 3 Gb/s and 1.5 Gb/s.
- USB ports 6 and 7 are disabled.
- USB ports 6, 7, 12 and 13 are disabled.
- SATA ports 2 and 3 are disabled.
- PCIe ports 7 and 8 are disabled.
- PCI Legacy Mode may optionally be used allowing external PCI bus support through a PCIe-to-PCI bridge. See [Section 5.1.9](#) for more details.
- Intel RST SSD Caching naming is not final at this time and is subject to change.



Table 1-3. Mobile Intel® 6 Series Chipset SKUs

Feature Set		SKU Name				
		QM67	UM67	HM67	HM65	QS67
PCI Express* 2.0 Ports		8	8	8	8	8
PCI Interface		No	No	No	No	No
USB* 2.0 Ports		14	14	14	12 ⁵	14
Total number of SATA ports		6	6	6	6	6
<ul style="list-style-type: none"> • SATA Ports (6 Gb/s, 3 Gb/s, and 1.5 Gb/s) • SATA Ports (3 Gb/s and 1.5 Gb/s only) 		2 ⁴	2 ⁴	2 ⁴	2 ⁴	2 ⁴
HDMI/DVI/VGA/SDVO/DisplayPort*/eDP*/LVDS		Yes	Yes	Yes	Yes	Yes
Integrated Graphics Support with PAVP 2.0		Yes	Yes	Yes	Yes	Yes
Intel® Rapid Storage Technology	AHCI	Yes	Yes	Yes	Yes	Yes
	RAID 0/1/5/10 Support	Yes	No	Yes	No	Yes
Intel® Anti-Theft		Yes	Yes	Yes	Yes	Yes
Intel® AMT 7.0		Yes	No	No	No	Yes

NOTES:

1. Contact your local Intel Field Sales Representative for currently available PCH SKUs
2. Table above shows feature difference between the PCH SKUs. If a feature is not listed in the table it is considered a Base feature that is included in all SKUs
3. The PCH provides hardware support for AHCI functionality when enabled by appropriate system configurations and software drivers.
4. SATA 6 Gb/s support on port 0 and port 1. SATA ports 0 and 1 also support 3 Gb/s and 1.5 Gb/s.
5. USB ports 6 and 7 are disabled on 12 port SKUs.

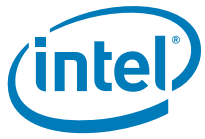

Table 1-4. Server/Workstation Intel® C200 Series Chipset SKUs

Feature Set		SKU Name		
		C206	C204	C202
PCI Express* 2.0 Ports		8	8	8
PCI Interface		Yes	Yes	Yes
USB 2.0 Ports		14	12 ⁵	12 ⁵
Total number of SATA Ports		6	6	6
• SATA Ports (6.0 Gb/s & 3.0 Gb/s & 1.5 Gb/s)		2 ⁴	2 ⁴	0
• SATA Ports (3.0 Gb/s & 1.5 Gb/s only)		4	4	6
HDMI*/DVI*/VGA/eDP*/DisplayPort*		Yes	No	No
Integrated Graphics Support with PAVP		Yes	No	No
Intel® Rapid Storage Technology	AHCI	Yes	Yes	Yes
	RAID 0/1/5/10 Support	Yes	Yes	Yes
Intel® Anti-Theft Technology		Yes	No	No
Intel® Active Management Technology 7.0		Yes	No	No

NOTES:

1. Contact your local Intel Field Sales Representative for currently available PCH SKUs.
2. Table above shows feature differences between the PCH SKUs. If a feature is not listed in the table it is considered a Base feature that is included in all SKUs
3. The PCH provides hardware support for AHCI functionality when enabled by appropriate system configurations and software drivers.
4. SATA 6 Gb/s support on port 0 and port 1. SATA ports 0 and 1 also support 3 Gb/s and 1.5 Gb/s.
5. USB ports 6 and 7 are disabled.

§ §





2 Signal Description

This chapter provides a detailed description of each signal. The signals are arranged in functional groups according to their associated interface.

The “#” symbol at the end of the signal name indicates that the active, or asserted state occurs when the signal is at a low voltage level. When “#” is not present, the signal is asserted when at the high voltage level.

The following notations are used to describe the signal type:

I	Input Pin
O	Output Pin
OD O	Open Drain Output Pin.
I/OD	Bi-directional Input/Open Drain Output Pin.
I/O	Bi-directional Input/Output Pin.
CMOS	CMOS buffers. 1.5 V tolerant.
COD	CMOS Open Drain buffers. 3.3 V tolerant.
HVCMOS	High Voltage CMOS buffers. 3.3 V tolerant.
A	Analog reference or output.

The “Type” for each signal is indicative of the functional operating mode of the signal. Unless otherwise noted in [Section 3.2](#) or [Section 3.3](#), a signal is considered to be in the functional operating mode after RTCRST# deasserts for signals in the RTC well, after RSMRST# deasserts for signals in the suspend well, after PWROK asserts for signals in the core well, after DPWROK asserts for Signals in the Deep S4/S5 well, after APWROK asserts for Signals in the Active Sleep well.

Figure 2-1. PCH Interface Signals Block Diagram (not all signals are on all SKUs)

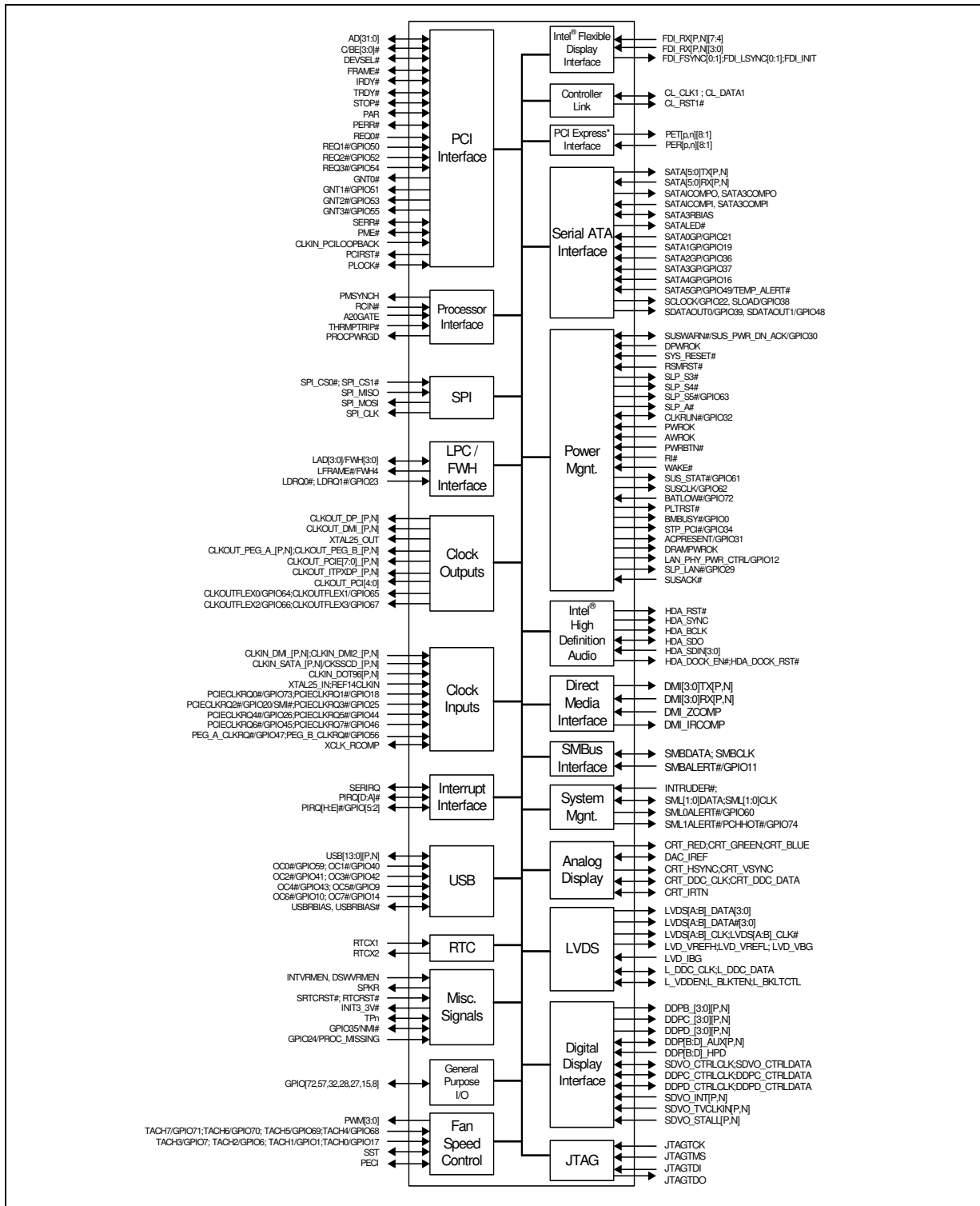



2.1 Direct Media Interface (DMI) to Host Controller

Table 2-1. Direct Media Interface Signals

Name	Type	Description
DMI0TXP, DMI0TXN	O	Direct Media Interface Differential Transmit Pair 0
DMI0RXP, DMI0RXN	I	Direct Media Interface Differential Receive Pair 0
DMI1TXP, DMI1TXN	O	Direct Media Interface Differential Transmit Pair 1
DMI1RXP, DMI1RXN	I	Direct Media Interface Differential Receive Pair 1
DMI2TXP, DMI2TXN	O	Direct Media Interface Differential Transmit Pair 2
DMI2RXP, DMI2RXN	I	Direct Media Interface Differential Receive Pair 2
DMI3TXP, DMI3TXN	O	Direct Media Interface Differential Transmit Pair 3
DMI3RXP, DMI3RXN	I	Direct Media Interface Differential Receive Pair 3
DMI_ZCOMP	I	Impedance Compensation Input: Determines DMI input impedance.
DMI_IRCOMP	O	Impedance/Current Compensation Output: Determines DMI output impedance and bias current.
DMI2RBIAS	I/O	DMI2RBIAS: Analog connection point for 750 Ω \pm 1% external precision resistor.

2.2 PCI Express*

Table 2-2. PCI Express* Signals (Sheet 1 of 2)

Name	Type	Description
PETp1, PETn1	O	PCI Express* Differential Transmit Pair 1
PERp1, PERn1	I	PCI Express Differential Receive Pair 1
PETp2, PETn2	O	PCI Express Differential Transmit Pair 2
PERp2, PERn2	I	PCI Express Differential Receive Pair 2
PETp3, PETn3	O	PCI Express Differential Transmit Pair 3
PERp3, PERn3	I	PCI Express Differential Receive Pair 3
PETp4, PETn4	O	PCI Express Differential Transmit Pair 4
PERp4, PERn4	I	PCI Express Differential Receive Pair 4
PETp5, PETn5	O	PCI Express Differential Transmit Pair 5
PERp5, PERn5	I	PCI Express Differential Receive Pair 5
PETp6, PETn6	O	PCI Express Differential Transmit Pair 6
PERp6, PERn6	I	PCI Express Differential Receive Pair 6
PETp7, PETn7	O	PCI Express Differential Transmit Pair 7

Table 2-2. PCI Express* Signals (Sheet 2 of 2)

Name	Type	Description
PERp7, PERn7	I	PCI Express Differential Receive Pair 7
PETp8, PETn8	O	PCI Express Differential Transmit Pair 8
PERp8, PERn8	I	PCI Express Differential Receive Pair 8

2.3 PCI Interface

Note: PCI Interface is only available on PCI Interface-enabled SKUs. However, certain PCI Interface signal functionality is available even on PCI Interface-disabled SKUs, as described below (see [Section 1.3](#) for full details on SKU definition).

Table 2-3. PCI Interface Signals (Sheet 1 of 2)

Name	Type	Description	Functionality Available on PCI Interface-disabled SKUs
AD[31:0]	I/O	PCI Address/Data: Reserved.	No
C/ BE[3:0]#	I/O	Bus Command and Byte Enables: Reserved.	No
DEVSEL#	I/O	Device Select: Reserved.	No
FRAME#	I/O	Cycle Frame: Reserved.	No
IRDY#	I/O	Initiator Ready: Reserved.	No
TRDY#	I/O	Target Ready: Reserved.	No
STOP#	I/O	Stop: Reserved.	No
PAR	I/O	Calculated/Checked Parity: Reserved.	No
PERR#	I/O	Parity Error: Reserved.	No
REQ0# REQ1#/ GPIO50 REQ2#/ GPIO52 REQ3#/ GPIO54	I	<p>PCI Requests: REQ functionality is Reserved. REQ[3:1]# pins can instead be used as GPIO.</p> <p>NOTES:</p> <ol style="list-style-type: none"> External pull-up resistor is required. When used as native functionality, the pull-up resistor may be to either 3.3 V or 5.0 V per PCI specification. When used as GPIO or not used at all, the pull-up resistor should be to the Vcc3_3 rail. 	No (GPIO only)
GNT0# GNT1#/ GPIO51 GNT2#/ GPIO53 GNT3#/ GPIO55	O	<p>PCI Grants: GNT functionality is Reserved. GNT[3:1]# pins can instead be used as GPIO.</p> <p>Pull-up resistors are not required on these signals. If pull-ups are used, they should be tied to the Vcc3_3 power rail.</p> <p>NOTES:</p> <ol style="list-style-type: none"> GNT[3:1]#/GPIO[55,53,51] are sampled as a functional strap. See Section 2.27 for details. 	No (GPIO and strap only)

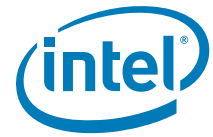
Table 2-3. PCI Interface Signals (Sheet 2 of 2)

Name	Type	Description	Functionality Available on PCI Interface-disabled SKUs
CLKIN_PCI LOOPBACK	I	PCI Clock: This is a 33 MHz clock feedback input to reduce skew between PCH PCI clock and clock observed by connected PCI devices. This signal must be connected to one of the pins in the group CLKOUT_PCI[4:0]	Yes
PCIRST#	O	PCI Reset: Reserved.	No
PLOCK#	I/O	PCI Lock: Reserved.	No
SERR#	I/OD	System Error: Reserved.	No
PME#	I/OD	PCI Power Management Event: PCI peripherals drive PME# to wake the system from low-power states S1–S5. PME# assertion can also be enabled to generate an SCI from the S0 state. In some cases the PCH may drive PME# active due to an internal wake event. The PCH will not drive PME# high, but it will be pulled up to VccSus3_3 by an internal pull-up resistor. Can be used with PCI legacy mode on platforms using a PCIe-to-PCI bridge. Downstream PCI devices would need to have PME# routed from the connector to the PCH PME# pin.	Yes

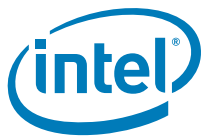

2.4 Serial ATA Interface

Table 2-4. Serial ATA Interface Signals (Sheet 1 of 3)

Name	Type	Description
SATA0TXP SATA0TXN	O	Serial ATA 0 Differential Transmit Pairs: These are outbound high-speed differential signals to Port 0. In compatible mode, SATA Port 0 is the primary master of SATA Controller 1. Supports up to 6 Gb/s, 3 Gb/s, and 1.5 Gb/s.
SATA0RXP SATA0RXN	I	Serial ATA 0 Differential Receive Pair: These are inbound high-speed differential signals from Port 0. In compatible mode, SATA Port 0 is the primary master of SATA Controller 1. Supports up to 6 Gb/s, 3 Gb/s, and 1.5 Gb/s.
SATA1TXP SATA1TXN	O	Serial ATA 1 Differential Transmit Pair: These are outbound high-speed differential signals to Port 1. In compatible mode, SATA Port 1 is the secondary master of SATA Controller 1. Supports up to 6 Gb/s, 3 Gb/s, and 1.5 Gb/s.
SATA1RXP SATA1RXN	I	Serial ATA 1 Differential Receive Pair: These are inbound high-speed differential signals from Port 1. In compatible mode, SATA Port 1 is the secondary master of SATA Controller 1. Supports up to 6 Gb/s, 3 Gb/s, and 1.5 Gb/s.
SATA2TXP SATA2TXN	O	Serial ATA 2 Differential Transmit Pair: These are outbound high-speed differential signals to Port 2. In compatible mode, SATA Port 2 is the primary slave of SATA Controller 1. Supports up to 3 Gb/s and 1.5 Gb/s. NOTE: SATA Port 2 may not be available in all PCH SKUs.
SATA2RXP SATA2RXN	I	Serial ATA 2 Differential Receive Pair: These are inbound high-speed differential signals from Port 2. In compatible mode, SATA Port 2 is the primary slave of SATA Controller 1. Supports up to 3 Gb/s and 1.5 Gb/s. NOTE: SATA Port 2 may not be available in all PCH SKUs.
SATA3TXP SATA3TXN	O	Serial ATA 3 Differential Transmit Pair: These are outbound high-speed differential signals to Port 3. In compatible mode, SATA Port 3 is the secondary slave of SATA Controller 1. Supports up to 3 Gb/s and 1.5 Gb/s. NOTE: SATA Port 3 may not be available in all PCH SKUs.



Table 2-4. Serial ATA Interface Signals (Sheet 2 of 3)

Name	Type	Description
SATA3RXP SATA3RXN	I	Serial ATA 3 Differential Receive Pair: These are inbound high-speed differential signals from Port 3. In compatible mode, SATA Port 3 is the secondary slave of SATA Controller 1. Supports up to 3 Gb/s and 1.5 Gb/s. NOTE: SATA Port 3 may not be available in all PCH SKUs.
SATA4TXP SATA4TXN	O	Serial ATA 4 Differential Transmit Pair: These are outbound high-speed differential signals to Port 4. In compatible mode, SATA Port 4 is the primary master of SATA Controller 2. Supports up to 3 Gb/s and 1.5 Gb/s.
SATA4RXP SATA4RXN	I	Serial ATA 4 Differential Receive Pair: These are inbound high-speed differential signals from Port 4. In compatible mode, SATA Port 4 is the primary master of SATA Controller 2. Supports up to 3 Gb/s and 1.5 Gb/s.
SATA5TXP SATA5TXN	O	Serial ATA 5 Differential Transmit Pair: These are outbound high-speed differential signals to Port 5. In compatible mode, SATA Port 5 is the secondary master of SATA Controller 2. Supports up to 3 Gb/s and 1.5 Gb/s.
SATA5RXP SATA5RXN	I	Serial ATA 5 Differential Receive Pair: These are inbound high-speed differential signals from Port 5. In compatible mode, SATA Port 5 is the secondary master of SATA Controller 2. Supports up to 3 Gb/s and 1.5 Gb/s.
SATAICOMPO	O	Serial ATA Compensation Output: Connected to an external precision resistor to VccCore. Must be connected to SATAICOMPI on the board.
SATAICOMPI	I	Serial ATA Compensation Input: Connected to SATAICOMPO on the board.
SATA0GP / GPIO21	I	Serial ATA 0 General Purpose: This is an input pin which can be configured as an interlock switch corresponding to SATA Port 0. When used as an interlock switch status indication, this signal should be drive to '0' to indicate that the switch is closed and to '1' to indicate that the switch is open. If interlock switches are not required, this pin can be configured as GPIO21.
SATA1GP / GPIO19	I	Serial ATA 1 General Purpose: Same function as SATA0GP, except for SATA Port 1. If interlock switches are not required, this pin can be configured as GPIO19.
SATA2GP / GPIO36	I	Serial ATA 2 General Purpose: Same function as SATA0GP, except for SATA Port 2. If interlock switches are not required, this pin can be configured as GPIO36.

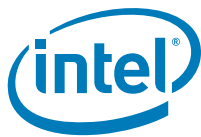

Table 2-4. Serial ATA Interface Signals (Sheet 3 of 3)

Name	Type	Description
SATA3GP / GPIO37	I	Serial ATA 3 General Purpose: Same function as SATA0GP, except for SATA Port 3. If interlock switches are not required, this pin can be configured as GPIO37.
SATA4GP / GPIO16 /	I	Serial ATA 4 General Purpose: Same function as SATA0GP, except for SATA Port 4. If interlock switches are not required, this pin can be configured as GPIO16 or MPGPIO9.
SATA5GP / GPIO49 / TEMP_ALERT#	I	Serial ATA 5 General Purpose: Same function as SATA0GP, except for SATA Port 5. If interlock switches are not required, this pin can be configured as GPIO49 or TEMP_ALERT#.
SATALED#	OD O	Serial ATA LED: This signal is an open-drain output pin driven during SATA command activity. It is to be connected to external circuitry that can provide the current to drive a platform LED. When active, the LED is on. When tri-stated, the LED is off. An external pull-up resistor to Vcc3_3 is required.
SCLOCK/ GPIO22	OD O	SGPIO Reference Clock: The SATA controller uses rising edges of this clock to transmit serial data, and the target uses the falling edge of this clock to latch data. The SClock frequency supported is 32 kHz. If SGPIO interface is not used, this signal can be used as GPIO22.
SLOAD/GPIO38	OD O	SGPIO Load: The controller drives a '1' at the rising edge of SCLOCK to indicate either the start or end of a bit stream. A 4-bit vendor specific pattern will be transmitted right after the signal assertion. If SGPIO interface is not used, this signal can be used as GPIO38.
SDATAOUT0/ GPIO39 SDATAOUT1/ GPIO48	OD O	SGPIO Dataout: Driven by the controller to indicate the drive status in the following sequence: drive 0, 1, 2, 3, 4, 5, 0, 1, 2... If SGPIO interface is not used, the signals can be used as GPIO.
SATA3RBIAS	I/O	SATA3 RBIAS: Analog connection point for a 750 Ω \pm 1% external precision resistor.
SATA3COMPI	I	Impedance Compensation Input: Connected to a 50 Ω (1%) precision external pull-up resistor to VccIO.
SATA3RCOMPO	O	Impedance/Current Compensation Output: Connected to a 50 Ω (1%) precision external pull-up resistor to VccIO



2.5 LPC Interface

Table 2-5. LPC Interface Signals

Name	Type	Description
LAD[3:0]	I/O	LPC Multiplexed Command, Address, Data: For LAD[3:0], internal pull-ups are provided.
LFRAME#	O	LPC Frame: LFRAME# indicates the start of an LPC cycle, or an abort.
LDRQ0#, LDRQ1# / GPIO23	I	LPC Serial DMA/Master Request Inputs: LDRQ[1:0]# are used to request DMA or bus master access. These signals are typically connected to an external Super I/O device. An internal pull-up resistor is provided on these signals. LDRQ1# may optionally be used as GPIO23.

2.6 Interrupt Interface

Table 2-6. Interrupt Signals

Name	Type	Description
SERIRQ	I/OD	Serial Interrupt Request: This pin implements the serial interrupt protocol.
PIRQ[D:A]#	I/OD	PCI Interrupt Requests: In non-APIC mode the PIRQx# signals can be routed to interrupts 3, 4, 5, 6, 7, 9, 10, 11, 12, 14 or 15 as described in Section 5.8.6 . Each PIRQx# line has a separate Route Control register. In APIC mode, these signals are connected to the internal I/O APIC in the following fashion: PIRQA# is connected to IRQ16, PIRQB# to IRQ17, PIRQC# to IRQ18, and PIRQD# to IRQ19. This frees the legacy interrupts. These signals are 5 V tolerant.
PIRQ[H:E]# / GPIO[5:2]	I/OD	PCI Interrupt Requests: In non-APIC mode the PIRQx# signals can be routed to interrupts 3, 4, 5, 6, 7, 9, 10, 11, 12, 14 or 15 as described in Section 5.8.6 . Each PIRQx# line has a separate Route Control register. In APIC mode, these signals are connected to the internal I/O APIC in the following fashion: PIRQE# is connected to IRQ20, PIRQF# to IRQ21, PIRQG# to IRQ22, and PIRQH# to IRQ23. This frees the legacy interrupts. If not needed for interrupts, these signals can be used as GPIO. These signals are 5 V tolerant.

NOTE: PIRQ Interrupts can only be shared if it is configured as level sensitive. They cannot be shared if configured as edge triggered.

2.7 USB Interface

Table 2-7. USB Interface Signals (Sheet 1 of 2)

Name	Type	Description
USBP0P, USBP0N, USBP1P, USBP1N	I/O	Universal Serial Bus Port [1:0] Differential: These differential pairs are used to transmit Data/Address/Command signals for ports 0 and 1. These ports can be routed to EHCI Controller 1. NOTE: No external resistors are required on these signals. The PCH integrates 15 k Ω pull-downs and provides an output driver impedance of 45 Ω which requires no external series resistor.
USBP2P, USBP2N, USBP3P, USBP3N	I/O	Universal Serial Bus Port [3:2] Differential: These differential pairs are used to transmit data/address/command signals for ports 2 and 3. These ports can be routed to EHCI Controller 1. NOTE: No external resistors are required on these signals. The PCH integrates 15 k Ω pull-downs and provides an output driver impedance of 45 Ω which requires no external series resistor.
USBP4P, USBP4N, USBP5P, USBP5N	I/O	Universal Serial Bus Port [5:4] Differential: These differential pairs are used to transmit Data/Address/Command signals for ports 4 and 5. These ports can be routed to EHCI Controller 1. NOTE: No external resistors are required on these signals. The PCH integrates 15 k Ω pull-downs and provides an output driver impedance of 45 Ω which requires no external series resistor.
USBP6P, USBP6N, USBP7P, USBP7N	I/O	Universal Serial Bus Port [7:6] Differential: These differential pairs are used to transmit Data/Address/Command signals for ports 6 and 7. These ports can be routed to EHCI Controller 1. NOTE: No external resistors are required on these signals. The PCH integrates 15 k Ω pull-downs and provides an output driver impedance of 45 Ω which requires no external series resistor.
USBP8P, USBP8N, USBP9P, USBP9N	I/O	Universal Serial Bus Port [9:8] Differential: These differential pairs are used to transmit Data/Address/Command signals for ports 8 and 9. These ports can be routed to EHCI Controller 2. NOTE: No external resistors are required on these signals. The PCH integrates 15 k Ω pull-downs and provides an output driver impedance of 45 Ω which requires no external series resistor.
USBP10P, USBP10N, USBP11P, USBP11N	I/O	Universal Serial Bus Port [11:10] Differential: These differential pairs are used to transmit Data/Address/Command signals for ports 10 and 11. These ports can be routed to EHCI Controller 2. NOTE: No external resistors are required on these signals. The PCH integrates 15 k Ω pull-downs and provides an output driver impedance of 45 Ω which requires no external series resistor.
USBP12P, USBP12N, USBP13P, USBP13N	I/O	Universal Serial Bus Port [13:12] Differential: These differential pairs are used to transmit Data/Address/Command signals for ports 13 and 12. These ports can be routed to EHCI Controller 2. NOTE: No external resistors are required on these signals. The PCH integrates 15 k Ω pull-downs and provides an output driver impedance of 45 Ω which requires no external series resistor.



Table 2-7. USB Interface Signals (Sheet 2 of 2)

Name	Type	Description
OC0# /GPIO59 OC1# /GPIO40 OC2# /GPIO41 OC3# /GPIO42 OC4# /GPIO43 OC5# /GPIO9 OC6# /GPIO10 OC7# /GPIO14	I	Overcurrent Indicators: These signals set corresponding bits in the USB controllers to indicate that an overcurrent condition has occurred. OC[7:0]# may optionally be used as GPIOs. NOTES: <ol style="list-style-type: none"> OC# pins are not 5 V tolerant. Depending on platform configuration, sharing of OC# pins may be required. OC[3:0]# can only be used for EHCI Controller 1 OC[4:7]# can only be used for EHCI Controller 2
USBRBIAS	O	USB Resistor Bias: Analog connection point for an external resistor. Used to set transmit currents and internal load resistors.
USBRBIAS#	I	USB Resistor Bias Complement: Analog connection point for an external resistor. Used to set transmit currents and internal load resistors.

2.8 Power Management Interface

Table 2-8. Power Management Interface Signals (Sheet 1 of 4)

Name	Type	Description
ACPRESENT / GPIO31	I	ACPRESENT: This input pin indicates when the platform is plugged into AC power or not. In addition to the previous Intel® ME to EC communication, the PCH uses this information to implement the Deep S4/S5 policies. For example, the platform may be configured to enter Deep S4/S5 when in S4 or S5 and only when running on battery. This is powered by Deep S4/S5 Well. This signal is muxed with GPIO31.
APWROK	I	Active Sleep Well (ASW) Power OK: When asserted, indicates that power to the ASW sub-system is stable.
BATLOW# (Mobile Only) / GPIO72	I	Battery Low: An input from the battery to indicate that there is insufficient power to boot the system. Assertion will prevent wake from S3–S5 state. This signal can also be enabled to cause an SMI# when asserted. NOTE: See Table 2.24 for Desktop implementation pin requirements.
BMBUSY# / GPIO0	I	Bus Master Busy: Generic bus master activity indication driven into the PCH. Can be configured to set the PM1_STS.BM_STS bit. Can also be configured to assert indications transmitted from the PCH to the processor using the PMSYNCH pin.
CLKRUN# (Mobile Only) / GPIO32 (Desktop Only)	I/O	PCI Clock Run: Used to support PCI CLKRUN protocol. Connects to peripherals that need to request clock restart or prevention of clock stopping.
DPWROK	I	DPWROK: Power OK Indication for the VccDSW3_3 voltage rail. This input is tied together with RSMRST# on platforms that do not support Deep S4/S5. This signal is in the RTC well.

Table 2-8. Power Management Interface Signals (Sheet 2 of 4)

Name	Type	Description
DRAMPWROK	OD O	DRAM Power OK: This signal should connect to the processor's SM_DRAMPWROK pin. The PCH asserts this pin to indicate when DRAM power is stable. This pin requires an external pull-up
LAN_PHY_PWR_CTRL / GPIO12	O	LAN PHY Power Control: LAN_PHY_PWR_CTRL should be connected to LAN_DISABLE_N on the PHY. PCH will drive LAN_PHY_PWR_CTRL low to put the PHY into a low power state when functionality is not needed. NOTES: 1. LAN_PHY_PWR_CTRL can only be driven low if SLP_LAN# is deasserted. 2. Signal can instead be used as GPIO12.
PLTRST#	O	Platform Reset: The PCH asserts PLTRST# to reset devices on the platform (such as SIO, FWH, LAN, processor, etc.). The PCH asserts PLTRST# during power-up and when S/W initiates a hard reset sequence through the Reset Control register (I/O Register CF9h). The PCH drives PLTRST# active a minimum of 1 ms when initiated through the Reset Control register (I/O Register CF9h). NOTE: PLTRST# is in the VccSus3_3 well.
PWRBTN#	I	Power Button: The Power Button will cause SMI# or SCI to indicate a system request to go to a sleep state. If the system is already in a sleep state, this signal will cause a wake event. If PWRBTN# is pressed for more than 4 seconds, this will cause an unconditional transition (power button override) to the S5 state. Override will occur even if the system is in the S1-S4 states. This signal has an internal pull-up resistor and has an internal 16 ms de-bounce on the input. This signal is in the DSW well.
PWROK	I	Power OK: When asserted, PWROK is an indication to the PCH that all of its core power rails have been stable for 10 ms. PWROK can be driven asynchronously. When PWROK is negated, the PCH asserts PLTRST#. NOTES: 1. It is required that the power rails associated with PCI/PCIe (typically the 3.3 V, 5 V, and 12 V core well rails) have been valid for 99 ms prior to PWROK assertion in order to comply with the 100 ms PCI 2.3/PCIe 1.1 specification on PLTRST# deassertion. 2. PWROK must not glitch, even if RSMRST# is low.
RI#	I	Ring Indicate: This signal is an input from a modem. It can be enabled as a wake event, and this is preserved across power failures.
RSMRST#	I	Resume Well Reset: This signal is used for resetting the resume power plane logic. This signal must be asserted for at least t201 after the suspend power wells are valid. When deasserted, this signal is an indication that the suspend power wells are stable.
SLP_A#	O	SLP_A#: Used to control power to the active sleep well (ASW) of the PCH.

Table 2-8. Power Management Interface Signals (Sheet 3 of 4)

Name	Type	Description
SLP_LAN# / GPIO29	O	<p>LAN Sub-System Sleep Control: When SLP_LAN# is deasserted it indicates that the PHY device must be powered. When SLP_LAN# is asserted, power can be shut off to the PHY device. SLP_LAN# will always be deasserted in S0 and anytime SLP_A# is deasserted.</p> <p>A SLP_LAN#/GPIO Select Soft-Strap can be used for systems NOT using SLP_LAN# functionality to revert to GPIO29 usage. When soft-strap is 0 (default), pin function will be SLP_LAN#. When soft-strap is set to 1, the pin returns to its regular GPIO mode.</p> <p>The pin behavior is summarized in Section 5.13.10.5.</p>
SLP_S3#	O	<p>S3 Sleep Control: SLP_S3# is for power plane control. This signal shuts off power to all non-critical systems when in S3 (Suspend To RAM), S4 (Suspend to Disk), or S5 (Soft Off) states.</p>
SLP_S4#	O	<p>S4 Sleep Control: SLP_S4# is for power plane control. This signal shuts power to all non-critical systems when in the S4 (Suspend to Disk) or S5 (Soft Off) state.</p> <p>NOTE: This pin must be used to control the DRAM power in order to use the PCH's DRAM power-cycling feature. Refer to Chapter 5.13.10.2 for details</p>
SLP_S5# / GPIO63	O	<p>S5 Sleep Control: SLP_S5# is for power plane control. This signal is used to shut power off to all non-critical systems when in the S5 (Soft Off) states.</p> <p>Pin may also be used as GPIO63.</p>
SLP_SUS#	O	<p>Deep S4/S5 Indication: When asserted low, this signal indicates PCH is in Deep S4/S5 state where internal Sus power is shut off for enhanced power saving. If Deep S4/S5 is not supported, then this pin can be left unconnected.</p> <p>This pin is in the DSW power well.</p>
STP_PCI# / GPIO34	O	<p>Stop PCI Clock: This signal is an output to the clock generator for it to turn off the PCI clock.</p>
SUSACK#	I	<p>SUSACK#: If Deep S4/S5 is supported, the EC/motherboard controlling logic must change SUSACK# to match SUSWARN# once the EC/motherboard controlling logic has completed the preparations discussed in the description for the SUSWARN# pin.</p> <p>NOTE: SUSACK# is only required to change in response to SUSWARN# if Deep S4/S5 is supported by the platform.</p> <p>This pin is in the Sus power well.</p>
SUS_STAT# / GPIO61	O	<p>Suspend Status: This signal is asserted by the PCH to indicate that the system will be entering a low power state soon. This can be monitored by devices with memory that need to switch from normal refresh to suspend refresh mode. It can also be used by other peripherals as an indication that they should isolate their outputs that may be going to powered-off planes.</p> <p>Pin may also be used as GPIO61.</p>
SUSCLK / GPIO62	O	<p>Suspend Clock: This clock is an output of the RTC generator circuit to use by other chips for refresh clock.</p> <p>Pin may also be used as GPIO62.</p>

Table 2-8. Power Management Interface Signals (Sheet 4 of 4)

Name	Type	Description
SUSWARN# / SUSPWRDNACK / GPIO30	O	<p>SUSWARN#: This pin asserts low when the PCH is planning to enter the Deep S4/S5 power state and remove Suspend power (using SLP_SUS#). The EC/motherboard controlling logic must observe edges on this pin, preparing for SUS well power loss on a falling edge and preparing for SUS well related activity (host/Intel ME wakes and runtime events) on a rising edge. SUSACK# must be driven to match SUSWARN# once the above preparation is complete. SUSACK# should be asserted within a minimal amount of time from SUSWARN# assertion as no wake events are supported if SUSWARN# is asserted but SUSACK# is not asserted. Platforms supporting Deep S4/S5, but not wishing to participate in the handshake during wake and Deep S4/S5 entry may tie SUSACK# to SUSWARN#.</p> <p>This pin may be muxed with a GPIO for use in systems that do not support Deep S4/S5. This pin is muxed with SUSPWRDNACK since it is not needed in Deep S4/S5 supported platforms.</p> <p>Reset type: RSMRST#</p> <p>This signal is multiplexed with GPIO30 and SUSPWRDNACK.</p>
SUSPWRDNACK / SUSWARN# / GPIO30	O	<p>SUSPWRDNACK: Active high. Asserted by the PCH on behalf of the Intel ME when it does not require the PCH Suspend well to be powered.</p> <p>Platforms are not expected to use this signal when the PCH's Deep S4/S5 feature is used.</p> <p>This signal is multiplexed with GPIO30 and SUSWARN#.</p>
SYS_PWROK	I	<p>System Power OK: This generic power good input to the PCH is driven and utilized in a platform-specific manner. While PWROK always indicates that the core wells of the PCH are stable, SYS_PWROK is used to inform the PCH that power is stable to some other system component(s) and the system is ready to start the exit from reset.</p>
SYS_RESET#	I	<p>System Reset: This pin forces an internal reset after being debounced. The PCH will reset immediately if the SMBus is idle; otherwise, it will wait up to 25 ms \pm 2 ms for the SMBus to idle before forcing a reset on the system.</p>
WAKE#	I	<p>PCI Express* Wake Event: Sideband wake signal on PCI Express asserted by components requesting wake up.</p>



2.9 Processor Interface

Table 2-9. Processor Interface Signals

Name	Type	Description
RCIN#	I	Keyboard Controller Reset Processor: The keyboard controller can generate INIT# to the processor. This saves the external OR gate with the PCH's other sources of INIT#. When the PCH detects the assertion of this signal, INIT# is generated using a VLW message to the processor. NOTE: The PCH will ignore RCIN# assertion during transitions to the S3, S4, and S5 states.
A20GATE	I	A20 Gate: A20GATE is from the keyboard controller. The signal acts as an alternative method to force the A20M# VLW message to the processor active.
PROCPWRGD	O	Processor Power Good: This signal should be connected to the processor's UNCOREPWRGOOD input to indicate when the processor power is valid.
PMSYNCH	O	Power Management Sync: Provides state information from the PCH to the processor
THRMTRIP#	I	Thermal Trip: When low, this signal indicates that a thermal trip from the processor occurred, and the PCH will immediately transition to a S5 state. The PCH will not wait for the processor stop grant cycle since the processor has overheated.

2.10 SMBus Interface

Table 2-10. SM Bus Interface Signals

Name	Type	Description
SMBDATA	I/OD	SMBus Data: External pull-up resistor is required.
SMBCLK	I/OD	SMBus Clock: External pull-up resistor is required.
SMBALERT# / GPIO11	I	SMBus Alert: This signal is used to wake the system or generate SMI#. This signal may be used as GPIO11.

2.11 System Management Interface

Table 2-11. System Management Interface Signals (Sheet 1 of 2)

Name	Type	Description
INTRUDER#	I	Intruder Detect: This signal can be set to disable the system if box detected open. This signal's status is readable, so it can be used like a GPI if the Intruder Detection is not needed.
SML0DATA	I/OD	System Management Link 0 Data: SMBus link to external PHY. External pull-up is required.
SML0CLK	I/OD	System Management Link 0 Clock: SMBus link to external PHY. External pull-up is required.
SML0ALERT# / GPIO60	O OD	SMLink Alert 0: Output of the integrated LAN controller to external PHY. External pull-up resistor is required. This signal can instead be used as GPIO60.

Table 2-11. System Management Interface Signals (Sheet 2 of 2)

Name	Type	Description
SML1ALERT# / PCHHOT# / GPIO74	O OD	SMLink Alert 1: Alert for the ME SMBus controller to optional Embedded Controller or BMC. External pull-up resistor is required. This signal can instead be used as PCHHOT# or GPIO74 NOTE: A soft-strap determines the native function SML1ALERT# or PCHHOT# usage. When soft-strap is 0, function is SML1ALERT#, when soft-strap is 1, function is PCHHOT#.
SML1CLK / GPIO58	I/OD	System Management Link 1 Clock: SMBus link to optional Embedded Controller or BMC. External pull-up resistor is required. This signal can instead be used as GPIO58
SML1DATA / GPIO75	I/OD	System Management Link 1 Data: SMBus link to optional Embedded Controller or BMC. External pull-up resistor is required. This signal can instead be used as GPIO75

2.12 Real Time Clock Interface

Table 2-12. Real Time Clock Interface

Name	Type	Description
RTCX1	Special	Crystal Input 1: This signal is connected to the 32.768 kHz crystal. If no external crystal is used, then RTCX1 can be driven with the desired clock rate.
RTCX2	Special	Crystal Input 2: This signal is connected to the 32.768 kHz crystal. If no external crystal is used, then RTCX2 should be left floating.

2.13 Miscellaneous Signals

Table 2-13. Miscellaneous Signals (Sheet 1 of 2)

Name	Type	Description
INTVRMEN	I	Internal Voltage Regulator Enable: This signal enables the internal 1.05 V regulators when pulled high. This signal must be always pulled-up to VccRTC on desktop platforms and may optionally be pulled low on mobile platforms if using an external VR for the DcpSus rail. NOTE: See VccCore signal description for behavior when INTVRMEN is sampled low (external VR mode).
DSWVRMEN	I	Deep S4/S5 Well Internal Voltage Regulator Enable: This signal enables the internal DSW 1.05 V regulators. This signal must be always pulled-up to VccRTC.
SPKR	O	Speaker: The SPKR signal is the output of counter 2 and is internally “ANDed” with Port 61h Bit 1 to provide Speaker Data Enable. This signal drives an external speaker driver device, which in turn drives the system speaker. Upon PLTRST#, its output state is 0. NOTE: SPKR is sampled as a functional strap. See Section 2.27 for more details. There is a weak integrated pull-down resistor on SPKR pin.



Table 2-13. Miscellaneous Signals (Sheet 2 of 2)

Name	Type	Description
RTCRST#	I	<p>RTC Reset: When asserted, this signal resets register bits in the RTC well.</p> <p>NOTES:</p> <ol style="list-style-type: none"> Unless CMOS is being cleared (only to be done in the G3 power state), the RTCRST# input must always be high when all other RTC power planes are on. In the case where the RTC battery is dead or missing on the platform, the RTCRST# pin must rise before the RSMRST# pin.
SRTCST#	I	<p>Secondary RTC Reset: This signal resets the manageability register bits in the RTC well when the RTC battery is removed.</p> <p>NOTES:</p> <ol style="list-style-type: none"> The SRTCST# input must always be high when all other RTC power planes are on. In the case where the RTC battery is dead or missing on the platform, the SRTCST# pin must rise before the RSMRST# pin.
SML1ALERT# / PCHHOT# / GPIO74	OD	<p>PCHHOT#: This signal is used to indicate a PCH temperature out of bounds condition to an external EC, when PCH temperature is greater than value programmed by BIOS. An external pull-up resistor is required on this signal.</p> <p>NOTE: A soft-strap determines the native function SML1ALERT# or PCHHOT# usage. When soft-strap is 0, function is SML1ALERT#, when soft-strap is 1, function is PCHHOT#.</p>
INIT3_3V#	O	<p>Initialization 3.3 V: INIT3_3V# is asserted by the PCH for 16 PCI clocks to reset the processor. This signal is intended for Firmware Hub.</p>
GPIO35 / NMI# (Server / Workstation Only)	OD O	<p>NMI#: This is an NMI event indication to an external controller (such as a BMC) on server/workstation platforms.</p> <p>When operating as NMI event indication pin function (enabled when "NMI SMI Event Native GPIO Enable" soft strap [PCHSTRP9:bit 16] is set to 1), the pin is OD (open drain).</p>
PCIECLKRQ2# / GPIO20 / SMI# (Server / Workstation Only)	OD O	<p>SMI#: This is an SMI event indication to an external controller (such as a BMC) on server/workstation platforms.</p> <p>When operating as SMI event indication pin function (enabled when "NMI SMI Event Native GPIO Enable" soft strap [PCHSTRP9:bit 16] is set to 1), the pin is OD (open drain).</p>

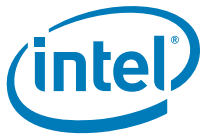

2.14 Intel® High Definition Audio Link

Table 2-14. Intel® High Definition Audio Link Signals

Name	Type	Description
HDA_RST#	O	Intel® High Definition Audio Reset: Master hardware reset to external codec(s).
HDA_SYNC	O	Intel High Definition Audio Sync: 48 kHz fixed rate sample sync to the codec(s). Also used to encode the stream number. NOTE: This signal is sampled as a functional strap. See Section 2.27 for more details. There is a weak integrated pull-down resistor on this pin.
HDA_BCLK	O	Intel High Definition Audio Bit Clock Output: 24.000 MHz serial data clock generated by the Intel High Definition Audio controller (the PCH).
HDA_SDO	O	Intel High Definition Audio Serial Data Out: Serial TDM data output to the codec(s). This serial output is double-pumped for a bit rate of 48 Mb/s for Intel High Definition Audio. NOTE: This signal is sampled as a functional strap. See Section 2.27 for more details. There is a weak integrated pull-down resistor on this pin.
HDA_SDIN[3:0]	I	Intel High Definition Audio Serial Data In [3:0]: Serial TDM data inputs from the codecs. The serial input is single-pumped for a bit rate of 24 Mb/s for Intel High Definition Audio. These signals have integrated pull-down resistors, which are always enabled. NOTE: During enumeration, the PCH will drive this signal. During normal operation, the CODEC will drive it.
HDA_DOCK_EN# /GPIO33	O	Intel High Definition Audio Dock Enable: This signal controls the external Intel HD Audio docking isolation logic. This is an active low signal. When deasserted the external docking switch is in isolate mode. When asserted the external docking switch electrically connects the Intel HD Audio dock signals to the corresponding PCH signals. This signal can instead be used as GPIO33.
HDA_DOCK_RST# / GPIO13	O	Intel High Definition Audio Dock Reset: This signal is a dedicated HDA_RST# signal for the codec(s) in the docking station. Aside from operating independently from the normal HDA_RST# signal, it otherwise works similarly to the HDA_RST# signal. This signal is shared with GPIO13. This signal defaults to GPIO13 mode after PLTRST#. BIOS is responsible for configuring GPIO13 to HDA_DOCK_RST# mode.



2.15 Controller Link

Table 2-15. Controller Link Signals

Signal Name	Type	Description
CL_RST1#	O	Controller Link Reset: Controller Link reset that connects to a Wireless LAN Device supporting Intel Active Management Technology.
CL_CLK1	I/O	Controller Link Clock: Bi-directional clock that connects to a Wireless LAN Device supporting Intel Active Management Technology.
CL_DATA1	I/O	Controller Link Data: Bi-directional data that connects to a Wireless LAN Device supporting Intel Active Management Technology.

2.16 Serial Peripheral Interface (SPI)

Table 2-16. Serial Peripheral Interface (SPI) Signals

Name	Type	Description
SPI_CS0#	O	SPI Chip Select 0: Used as the SPI bus request signal.
SPI_CS1#	O	SPI Chip Select 1: Used as the SPI bus request signal.
SPI_MISO	I	SPI Master IN Slave OUT: Data input pin for PCH.
SPI_MOSI	I/O	SPI Master OUT Slave IN: Data output pin for PCH.
SPI_CLK	O	SPI Clock: SPI clock signal, during idle the bus owner will drive the clock signal low. 17.86 MHz and 31.25 MHz.

2.17 Thermal Signals

Table 2-17. Thermal Signals (Sheet 1 of 2)

Signal Name	Type	Description
PWM[3:0] (Server/ Workstation Usage Only); Not available in Mobile & Desktop)	OD O	Fan Pulse Width Modulation Outputs: Pulse Width Modulated duty cycle output signals used for fan control. These signals are 5 V tolerant.
TACH0 / GPIO17 TACH1 / GPIO1 TACH2 / GPIO6 TACH3 / GPIO7 TACH4 / GPIO68 TACH5 / GPIO69 TACH6 / GPIO70 TACH7 / GPIO71 (TACH* signals used on Server/ Workstation Only; not available in Mobile & Desktop)	I	Fan Tachometer Inputs: Tachometer pulse input signal that is used to measure fan speed. This signal is connected to the "Sense" signal on the fan. Can instead be used as a GPIO.

Table 2-17. Thermal Signals (Sheet 2 of 2)

Signal Name	Type	Description
SST (Server/ Workstation Usage Only; not available in Mobile & Desktop)	I/O	Simple Serial Transport: Single-wire, serial bus. Connect to SST compliant devices such as SST thermal sensors or voltage sensors.
PECI	I/O	Platform Environment Control Interface: Single-wire, serial bus.

2.18 Testability Signals

Table 2-18. Testability Signals

Name	Type	Description
JTAG_TCK	I	Test Clock Input (TCK): The test clock input provides the clock for the JTAG test logic.
JTAG_TMS	I	Test Mode Select (TMS): The signal is decoded by the Test Access Port (TAP) controller to control test operations.
JTAG_TDI	I	Test Data Input (TDI): Serial test instructions and data are received by the test logic at TDI.
JTAG_TDO	OD	Test Data Output (TDO): TDO is the serial output for test instructions and data from the test logic defined in this standard.

NOTE: JTAG Pin definitions are from IEEE Standard Test Access Port and Boundary-Scan Architecture (IEEE Std. 1149.1-2001)

2.19 Clock Signals

Table 2-19. Clock Interface Signals (Sheet 1 of 3)

Name	Type	Description
CLKOUT_ITPXDP_P, CLKOUT_ITPXDP_N	O	100 MHz Differential output to processor XDP/ITP connector on platform
CLKOUT_DP_P, CLKOUT_DP_N	O	120 MHz Differential output for DisplayPort reference
CLKIN_DMI_P, CLKIN_DMI_N	I	Unused. NOTE: External pull-down input termination is required
CLKOUT_DMI_P, CLKOUT_DMI_N	O	100 MHz PCIe Gen2 specification jitter tolerant differential output to processor.
CLKIN_SATA_P, CLKIN_SATA_N	I	Unused. NOTE: External pull-down input termination is required
CLKIN_DOT96_P, CLKIN_DOT96_N	I	Unused. NOTE: External pull-down input termination is required
XTAL25_IN	I	Connection for 25 MHz crystal to PCH oscillator circuit.
XTAL25_OUT	O	Connection for 25 MHz crystal to PCH oscillator circuit.
REFCLK14IN	I	Unused. NOTE: External pull-down input termination is required



Table 2-19. Clock Interface Signals (Sheet 2 of 3)

Name	Type	Description
CLKOUT_PEG_A_P, CLKOUT_PEG_A_N	O	100 MHz Gen2 PCIe specification differential output to PCI Express* Graphics device
CLKOUT_PEG_B_P, CLKOUT_PEG_B_N	O	100 MHz Gen2 PCIe specification differential output to a second PCI Express Graphics device
PEG_A_CLKRQ# / GPIO47 (Mobile Only), PEG_B_CLKRQ# / GPIO56 (Mobile Only)	I	Clock Request Signals for PCIe Graphics SLOTS Can instead by used as GPIOs NOTE: External pull-up resistor required if used for CLKREQ# functionality
CLKOUT_PCIE[7:0] _P, CLKOUT_PCIE[7:0] _N	O	100 MHz PCIe Gen2 specification differential output to PCI Express devices
CLKIN_GND0_P, CLKIN_GND0_N (Desktop Only) CLKIN_GND1_P, CLKIN_GND1_N	I	Requires external pull-down termination (can be shared between P and N signals of the differential pair).
PCIECLKRQ0# / GPIO73, PCIECLKRQ1# / GPIO18, PCIECLKRQ3# / GPIO25, PCIECLKRQ4# / GPIO26 (all the above CLKRQ# signals are Mobile Only)	I	Clock Request Signals for PCI Express 100 MHz Clocks Can instead by used as GPIOs NOTE: External pull-up resistor required if used for CLKREQ# functionality
PCIECLKRQ2# / GPIO20 / SMI#, PCIECLKRQ5# / GPIO44, PCIECLKRQ6# / GPIO45, PCIECLKRQ7# / GPIO46 (SMI# above is server/workstation only)	I	Clock Request Signals for PCI Express 100 MHz Clocks Can instead by used as GPIOs NOTE: External pull-up resistor required if used for CLKREQ# functionality
CLKOUT_PCI[4:0]	O	Single-Ended, 33 MHz outputs to PCI connectors/devices. One of these signals must be connected to CLKIN_PCILoopBACK to function as a PCI clock loopback. This allows skew control for variable lengths of CLKOUT_PCI[4:0] .
CLKIN_PCILoopBACK	I	33 MHz PCI clock feedback input, to reduce skew between PCH on-die PCI clock and PCI clock observed by connected PCI devices
CLKOUTFLEX0¹ / GPIO64	O	Configurable as a GPIO or as a programmable output clock which can be configured as one of the following: <ul style="list-style-type: none"> • 33 MHz • 27 MHz (SSC/Non-SSC) • 48/24 MHz • 14.318 MHz • DC Output logic '0'

Table 2-19. Clock Interface Signals (Sheet 3 of 3)

Name	Type	Description
CLKOUTFLEX1¹ / GPIO65	O	Configurable as a GPIO or as a programmable output clock which can be configured as one of the following: <ul style="list-style-type: none"> • Non functional and unsupported clock output value (Default) • 27 MHz (SSC/Non-SSC) • 14.318 MHz output to SIO/EC • 48/24 MHz • DC Output logic '0'
CLKOUTFLEX2¹ / GPIO66	O	Configurable as a GPIO or as a programmable output clock which can be configured as one of the following: <ul style="list-style-type: none"> • 33 MHz • 25 MHz • 27 MHz (SSC/Non-SSC) • 48/24 MHz • 14.318 MHz • DC Output logic '0'
CLKOUTFLEX3¹ / GPIO67	O	Configurable as a GPIO or as a programmable output clock which can be configured as one of the following: <ul style="list-style-type: none"> • 27 MHz (SSC/Non SSC) • 14.318 MHz output to SIO • 48/24 MHz (Default) • DC Output logic '0'
XCLK_RCOMP	I/O	Differential clock buffer Impedance Compensation: Connected to an external precision resistor (90.9 Ω \pm 1%) to VccDIFFCLKN

NOTE:

1. It is highly recommended to prioritize 27/14.318/24/48 MHz clocks on CLKOUTFLEX1 and CLKOUTFLEX3 outputs. Intel does not recommend configuring the 27/14.318/24/48 MHz clocks on CLKOUTFLEX0 and CLKOUTFLEX2 if more than 2x 33 MHz clocks in addition to the Feedback clock are used on the CLKOUT_PCI outputs.



2.20 LVDS Signals

All signals are Mobile Only, except as signals noted otherwise that are available in the desktop package.

Table 2-20. LVDS Interface Signals

Name	Type	Description
LVDSA_DATA[3:0]	O	LVDS Channel A differential data output - positive
LVDSA_DATA#[3:0]	O	LVDS Channel A differential data output - negative
LVDSA_CLK	O	LVDS Channel A differential clock output - positive
LVDSA_CLK#	O	LVDS Channel A differential clock output - negative
LVDSB_DATA[3:0]	O	LVDS Channel B differential data output - positive
LVDSB_DATA#[3:0]	O	LVDS Channel B differential data output - negative
LVDSB_CLK	O	LVDS Channel B differential clock output - positive
LVDSB_CLK#	O	LVDS Channel B differential clock output - negative
L_DDC_CLK	I/O	EDID support for flat panel display
L_DDC_DATA	I/O	EDID support for flat panel display
L_CTRL_CLK	I/O	Control signal (clock) for external SSC clock chip control - optional
L_CTRL_DATA	I/O	Control signal (data) for external SSC clock chip control - optional
L_VDD_EN (available in Desktop)	O	LVDS Panel Power Enable: Panel power control enable control for LVDS or embedded DisplayPort*. This signal is also called VDD_DBL in the CPIS specification and is used to control the VDC source to the panel logic.
L_BKLTEN (available in Desktop)	O	LVDS Backlight Enable: Panel backlight enable control for LVDS or embedded DisplayPort. This signal is also called ENA_BL in the CPIS specification and is used to gate power into the backlight circuitry.
L_BKLTCTL (available in Desktop)	O	Panel Backlight Brightness Control: Panel brightness control for LVDS or embedded DisplayPort. This signal is also called VARY_BL in the CPIS specification and is used as the PWM Clock input signal.
LVDS_VREFH	O	Test mode voltage reference.
LVDS_VREFL	O	Test mode voltage reference.
LVD_IBG	I	LVDS reference current.
LVD_VBG	O	Test mode voltage reference.

2.21 Analog Display /VGA DAC Signals

Table 2-21. Analog Display Interface Signals

Name	Type	Description
VGA_RED	O A	RED Analog Video Output: This signal is a VGA Analog video output from the internal color palette DAC.
VGA_GREEN	O A	GREEN Analog Video Output: This signal is a VGA Analog video output from the internal color palette DAC.
VGA_BLUE	O A	BLUE Analog Video Output: This signal is a VGA Analog video output from the internal color palette DAC.
DAC_IREF	I/O A	Resistor Set: Set point resistor for the internal color palette DAC. A 1 k Ω 1% resistor is required between DAC_IREF and motherboard ground.
VGA_HSYNC	O HVCMOS	VGA Horizontal Synchronization: This signal is used as the horizontal sync (polarity is programmable) or "sync interval". 2.5 V output
VGA_VSYNC	O HVCMOS	VGA Vertical Synchronization: This signal is used as the vertical sync (polarity is programmable). 2.5 V output.
VGA_DDC_CLK	I/O COD	Monitor Control Clock
VGA_DDC_DATA	I/O COD	Monitor Control Data
VGA_IRTN	I/O COD	Monitor Interrupt Return

2.22 Intel[®] Flexible Display Interface (Intel[®] FDI)

Table 2-22. Intel[®] Flexible Display Interface Signals

Signal Name	Type	Description
FDI_RXP[3:0]	I	Display Link 1 positive data in
FDI_RXN[3:0]	I	Display Link 1 negative data in
FDI_FSYNC[0]	O	Display Link 1 Frame sync
FDI_LSYNC[0]	O	Display Link 1 Line sync
FDI_RXP[7:4]	I	Display Link 2 positive data in
FDI_RXN[7:4]	I	Display Link 2 negative data in
FDI_FSYNC[1]	O	Display Link 2 Frame sync
FDI_LSYNC[1]	O	Display Link 2 Line sync
FDI_INT	O	Used for Display interrupts from PCH to processor.



2.23 Digital Display Signals

Table 2-23. Digital Display Interface Signals (Sheet 1 of 3)

Name	Type	Description
DDPB_[3:0]P	O	<p>Port B: Capable of SDVO / HDMI / DVI / DisplayPort</p> <p>SDVO DDPB_[0]P: red DDPB_[1]P: green DDPB_[2]P: blue DDPB_[3]P: clock</p> <p>HDMI / DVI Port B Data and Clock Lines DDPB_[0]P: TMDSB_DATA2 DDPB_[1]P: TMDSB_DATA1 DDPB_[2]P: TMDSB_DATA0 DDPB_[3]P: TMDSB_CLK</p> <p>DisplayPort Port B DDPB_[0]P: Display Port Lane 0 DDPB_[1]P: Display Port Lane 1 DDPB_[2]P: Display Port Lane 2 DDPB_[3]P: Display Port Lane 3</p>
DDPB_[3:0]N	O	<p>Port B: Capable of SDVO / HDMI / DVI / DisplayPort</p> <p>SDVO DDPB_[0]N: red complement DDPB_[1]N: green complement DDPB_[2]N: blue complement DDPB_[3]N: clock complement</p> <p>HDMI / DVI Port B Data and Clock Line Complements DDPB_[0]N: TMDSB_DATA2B DDPB_[1]N: TMDSB_DATA1B DDPB_[2]N: TMDSB_DATA0B DDPB_[3]N: TMDSB_CLKB</p> <p>DisplayPort Port B DDPB_[0]N: Display Port Lane 0 complement DDPB_[1]N: Display Port Lane 1 complement DDPB_[2]N: Display Port Lane 2 complement DDPB_[3]N: Display Port Lane 3 complement</p>
DDPB_AUXP	I/O	Port B: DisplayPort Aux
DDPB_AUXN	I/O	Port B: DisplayPort Aux Complement
DDPB_HPD	I	Port B: TMDSB_HPD Hot Plug Detect
SDVO_CTRLCLK	I/O	Port B: HDMI Control Clock. Shared with port B SDVO

Table 2-23. Digital Display Interface Signals (Sheet 2 of 3)

Name	Type	Description
SDVO_CTRLDATA	I/O	Port B: HDMI Control Data. Shared with Port B SDVO
SDVO_INTP	I	SDVO_INTP: Serial Digital Video Input Interrupt
SDVO_INTN	I	SDVO_INTN: Serial Digital Video Input Interrupt Complement.
SDVO_TVCLKINP	I	SDVO_TVCLKINP: Serial Digital Video TVOUT Synchronization Clock.
SDVO_TVCLKINN	I	SDVO_TVCLKINN: Serial Digital Video TVOUT Synchronization Clock Complement.
SDVO_STALLP	I	SDVO_STALLP: Serial Digital Video Field Stall.
SDVO_STALLN	I	SDVO_STALLN: Serial Digital Video Field Stall Complement.
DDPC_[3:0]P	O	<p>Port C: Capable of HDMI / DVI / DP</p> <p>HDMI / DVI Port C Data and Clock Lines DDPC_[0]P: TMDSC_DATA2 DDPC_[1]P: TMDSC_DATA1 DDPC_[2]P: TMDSC_DATA0 DDPC_[3]P: TMDSC_CLK</p> <p>DisplayPort Port C DDPC_[0]P: Display Port Lane 0 DDPC_[1]P: Display Port Lane 1 DDPC_[2]P: Display Port Lane 2 DDPC_[3]P: Display Port Lane 3</p>
DDPC_[3:0]N	O	<p>Port C: Capable of HDMI / DVI / DisplayPort</p> <p>HDMI / DVI Port C Data and Clock Line Complements DDPC_[0]N: TMDSC_DATA2B DDPC_[1]N: TMDSC_DATA1B DDPC_[2]N: TMDSC_DATA0B DDPC_[3]N: TMDSC_CLKB</p> <p>DisplayPort Port C Complements DDPC_[0]N: Lane 0 complement DDPC_[1]N: Lane 1 complement DDPC_[2]N: Lane 2 complement DDPC_[3]N: Lane 3 complement</p>
DDPC_AUXP	I/O	Port C: Display Port Aux
DDPC_AUXN	I/O	Port C: Display Port Aux Complement
DDPC_HPD	I	Port C: TMDSC_HPD Hot Plug Detect
DDPC_CTRLCLK	I/O	HDMI Port C Control Clock
DDPC_CTRLDATA	I/O	HDMI Port C Control Data



Table 2-23. Digital Display Interface Signals (Sheet 3 of 3)

Name	Type	Description
DDPD_[3:0]P	O	<p>Port D: Capable of HDMI / DVI / DP</p> <p>HDMI / DVI Port D Data and Clock Lines DDPD_[0]P: TMDSC_DATA2 DDPD_[1]P: TMDSC_DATA1 DDPD_[2]P: TMDSC_DATA0 DDPD_[3]P: TMDSC_CLK</p> <p>DisplayPort Port D DDPD_[0]P: Display Port Lane 0 DDPD_[1]P: Display Port Lane 1 DDPD_[2]P: Display Port Lane 2 DDPD_[3]P: Display Port Lane 3</p>
DDPD_[3:0]N	O	<p>Port D: Capable of HDMI / DVI / DisplayPort</p> <p>HDMI / DVI Port D Data and Clock Line Complements DDPD_[0]N: TMDSC_DATA2B DDPD_[1]N: TMDSC_DATA1B DDPD_[2]N: TMDSC_DATA0B DDPD_[3]N: TMDSC_CLKB</p> <p>DisplayPort Port D Complements DDPD_[0]N: Lane 0 complement DDPD_[1]N: Lane 1 complement DDPD_[2]N: Lane 2 complement DDPD_[3]N: Lane 3 complement</p>
DDPD_AUXP	I/O	Port D: DisplayPort Aux
DDPD_AUXN	I/O	Port D: DisplayPort Aux Complement
DDPD_HPD	I	Port D: TMDSD_HPD Hot Plug Detect
DDPD_CTRLCLK	I/O	HDMI Port D Control Clock
DDPD_CTRLDATA	I/O	HDMI Port D Control Data



2.24 General Purpose I/O Signals

Notes:

1. GPIO Configuration registers within the Core Well are reset whenever PWROK is deasserted.
2. GPIO Configuration registers within the Suspend Well are reset when RSMRST# is asserted, CF9h reset (06h or 0Eh), or SYS_RESET# is asserted. However, CF9h reset and SYS_RESET# events can be masked from resetting the Suspend well GPIO by programming appropriate GPIO Reset Select (GPIO_RST_SEL) registers.
3. GPIO24 is an exception to the other GPIO Signals in the Suspend Well and is not reset by CF9h reset (06h or 0Eh)

Table 2-24. General Purpose I/O Signals (Sheet 1 of 4)

Name	Type	Tolerance	Power Well	Default	Blink Capability	Description
GPIO75	I/O	3.3 V	Suspend	Native	No	Multiplexed with SML1DATA (Note 11)
GPIO74	I/O	3.3 V	Suspend	Native	No	Multiplexed with SML1ALERT#/PCHHOT# (Note 11)
GPIO73 (Mobile Only)	I/O	3.3 V	Suspend	Native	No	Multiplexed with PCIECLKRQ0#
GPIO72	I/O	3.3 V	Suspend	Native (Mobile Only)	No	Mobile: Multiplexed with BATLOW#. Desktop: Unmultiplexed; requires pull-up resistor. (Note 4)
GPIO[71:70]	I/O	3.3 V	Core	Native	No	Desktop: Multiplexed with TACH[7:6] Mobile: Used as GPIO only
GPIO[69:68]	I/O	3.3 V	Core	GPI	No	Desktop: Multiplexed with TACH[5:4] Mobile: Used as GPIO only
GPIO67	I/O	3.3 V	Core	Native	No	Multiplexed with CLKOUTFLEX3
GPIO66	I/O	3.3 V	Core	Native	No	Multiplexed with CLKOUTFLEX2
GPIO65	I/O	3.3 V	Core	Native	No	Multiplexed with CLKOUTFLEX1
GPIO64	I/O	3.3 V	Core	Native	No	Multiplexed with CLKOUTFLEX0
GPIO63	I/O	3.3 V	Suspend	Native	No	Multiplexed with SLP_S5#
GPIO62	I/O	3.3 V	Suspend	Native	No	Multiplexed with SUSCLK
GPIO61	I/O	3.3 V	Suspend	Native	No	Multiplexed with SUS_STAT#
GPIO60	I/O	3.3 V	Suspend	Native	No	Multiplexed with SML0ALERT#
GPIO59	I/O	3.3 V	Suspend	Native	No	Multiplexed with OC0# (Note 11)
GPIO58	I/O	3.3 V	Suspend	Native	No	Multiplexed with SML1CLK
GPIO57	I/O	3.3 V	Suspend	GPI	No	Unmultiplexed
GPIO56 (Mobile Only)	I/O	3.3 V	Suspend	Native	No	Mobile: Multiplexed with PEG_B_CLKRQ#
GPIO55	I/O	3.3 V	Core	Native	No	Desktop: Multiplexed with GNT3# Mobile: Used as GPIO only



Table 2-24. General Purpose I/O Signals (Sheet 2 of 4)

Name	Type	Tolerance	Power Well	Default	Blink Capability	Description
GPIO54	I/O	5.0 V	Core	Native	No	Desktop: Multiplexed with REQ3#. (Note 11) Mobile: Used as GPIO only
GPIO53	I/O	3.3 V	Core	Native	No	Desktop: Multiplexed with GNT2# Mobile: Used as GPIO only
GPIO52	I/O	5.0 V	Core	Native	No	Desktop: Multiplexed with REQ2#. (Note 11) Mobile: Used as GPIO only
GPIO51	I/O	3.3 V	Core	Native	No	Desktop: Multiplexed with GNT1# Mobile: Used as GPIO only
GPIO50	I/O	5.0 V	Core	Native	No	Desktop: Multiplexed with REQ1#. (Note 11) Mobile: Used as GPIO only
GPIO49	I/O	3.3 V	Core	GPI	No	Multiplexed with SATA5GP and TEMP_ALERT#
GPIO48	I/O	3.3 V	Core	GPI	No	Multiplexed with SDATAOUT1.
GPIO47 (Mobile Only)	I/O	3.3 V	Suspend	Native	No	Multiplexed with PEG_A_CLKRQ#
GPIO46	I/O	3.3 V	Suspend	Native	No	Multiplexed with PCIECLKRQ7#
GPIO45	I/O	3.3 V	Suspend	Native	No	Multiplexed with PCIECLKRQ6#
GPIO44	I/O	3.3 V	Suspend	Native	No	Multiplexed with PCIECLKRQ5#
GPIO[43:40]	I/O	3.3 V	Suspend	Native	No	Multiplexed with OC[4:1]# (Note 11)
GPIO39	I/O	3.3 V	Core	GPI	No	Multiplexed with SDATAOUT0.
GPIO38	I/O	3.3 V	Core	GPI	No	Multiplexed with SLOAD.
GPIO37	I/O	3.3 V	Core	GPI	No	Multiplexed with SATA3GP.
GPIO36	I/O	3.3 V	Core	GPI	No	Multiplexed with SATA2GP.
GPIO35	I/O	3.3 V	Core	GPO	No	Multiplexed with NMI#.
GPIO34	I/O	3.3 V	Core	GPI	No	Multiplexed with STP_PCI#
GPIO33	I/O	3.3 V	Core	GPO	No	Mobile: Multiplexed with HDA_DOCK_EN# (Mobile Only) (Note 4) Desktop: Used as GPIO only
GPIO32 (not available in Mobile)	I/O	3.3 V	Core	GPO, Native (Mobile only)	No	Unmultiplexed (Desktop Only) Mobile Only: Used as CLKRUN#, unavailable as GPIO (Note 4)
GPIO31	I/O	3.3 V	DSW	GPI	Yes	Multiplexed with ACPRESENT (Mobile Only) (Note 6) Desktop: Used as GPIO31 only. Unavailable as ACPRESENT



Table 2-24. General Purpose I/O Signals (Sheet 3 of 4)

Name	Type	Tolerance	Power Well	Default	Blink Capability	Description
GPIO30	I/O	3.3 V	Suspend	Native	Yes	Multiplexed with SUSPWRDNACK, SUSWARN# Desktop: Can be configured as SUSWARN# or GPIO30 only. Cannot be used as SUSPWRDNACK. Mobile: Used as SUSPWRDNACK, SUSWARN#, or GPIO30
GPIO29	I/O	3.3 V	Suspend	GPI	No	Multiplexed with SLP_LAN# Pin usage as GPIO is determined by SLP_LAN#/GPIO Select Soft-strap. When soft-strap = 1, pin can be used as GPIO and defaults to GP Input (Note 10)
GPIO28	I/O	3.3 V	Suspend	GPO	Yes	Unmultiplexed
GPIO27	I/O	3.3 V	DSW	GPI	Yes	Unmultiplexed. Can be configured as wake input to allow wakes from Deep S4/S5.
GPIO26 (Mobile Only)	I/O	3.3 V	Suspend	Native	Yes	Mobile: Multiplexed with PCIECLKRQ4#
GPIO25 (Mobile Only)	I/O	3.3 V	Suspend	Native	Yes	Mobile: Multiplexed with PCIECLKRQ3#
GPIO24	I/O	3.3 V	Suspend	GPO	Yes	Desktop: Can be used as PROC_MISSING configured using Intel ME firmware. Mobile: Unmultiplexed NOTE: GPIO24 configuration register bits are not cleared by CF9h reset event.
GPIO23	I/O	3.3 V	Core	Native	Yes	Multiplexed with LDRQ1#.
GPIO22	I/O	3.3 V	Core	GPI	Yes	Multiplexed with SCLOCK
GPIO21	I/O	3.3 V	Core	GPI	Yes	Multiplexed with SATA0GP
GPIO20	I/O	3.3 V	Core	Native	Yes	Multiplexed with PCIECLKRQ2#, SMI#
GPIO19	I/O	3.3 V	Core	GPI	Yes	Multiplexed with SATA1GP
GPIO18 (Mobile Only)	I/O	3.3 V	Core	Native	Yes (Note 7)	Mobile: Multiplexed with PCIECLKRQ1#
GPIO17	I/O	3.3 V	Core	GPI	Yes	Desktop: Multiplexed with TACH0. Mobile: Used as GPIO17 only.
GPIO16	I/O	3.3 V	Core	GPI	Yes	Multiplexed with SATA4GP
GPIO15	I/O	3.3 V	Suspend	GPO	Yes	Unmultiplexed
GPIO14	I/O	3.3 V	Suspend	Native	Yes	Multiplexed with OC7#
GPIO13	I/O	3.3 V	Suspend	GPI	Yes	Multiplexed with HDA_DOCK_RST# (Mobile Only) (Note 4) Desktop: Used as GPIO only



Table 2-24. General Purpose I/O Signals (Sheet 4 of 4)

Name	Type	Tolerance	Power Well	Default	Blink Capability	Description
GPIO12	I/O	3.3 V	Suspend	Native	Yes	Multiplexed with LAN_PHY_PWR_CTRL. GPIO / Native functionality controlled using soft strap (Note 8)
GPIO11	I/O	3.3 V	Suspend	Native	Yes	Multiplexed with SMBALERT#. (Note 11)
GPIO10	I/O	3.3 V	Suspend	Native	Yes	Multiplexed with OC6# (Note 11)
GPIO9	I/O	3.3 V	Suspend	Native	Yes	Multiplexed with OC5# (Note 11)
GPIO8	I/O	3.3 V	Suspend	GPO	Yes	Unmultiplexed
GPIO[7:6]	I/O	3.3 V	Core	GPI	Yes	Multiplexed with TACH[3:2]. Mobile: Used as GPIO[7:6] only.
GPIO[5:2]	I/OD	5 V	Core	GPI	Yes	Multiplexed PIRQ[H:E]# (Note 5).
GPIO1	I/O	3.3 V	Core	GPI	Yes	Multiplexed with TACH1. Mobile: Used as GPIO1 only.
GPIO0	I/O	3.3 V	Core	GPI	Yes	Multiplexed with BMBUSY#

NOTES:

- All GPIOs can be configured as either input or output.
- GPI[15:0] can be configured to cause a SMI# or SCI. Note that a GPI can be routed to either an SMI# or an SCI, but not both.
- Some GPIOs exist in the VccSus3_3 power plane. Care must be taken to make sure GPIO signals are not driven high into powered-down planes. Also, external devices should not be driving powered down GPIOs high. Some GPIOs may be connected to pins on devices that exist in the core well. If these GPIOs are outputs, there is a danger that a loss of core power (PWROK low) or a Power Button Override event will result in the PCH driving a pin to a logic 1 to another device that is powered down.
- The functionality that is multiplexed with the GPIO may not be used in desktop configuration.
- When this signal is configured as GPO the output stage is an open drain.
- In an Intel® ME disabled system, GPIO31 may be used as ACPRESENT from the EC.
- GPIO18 will toggle at a frequency of approximately 1 Hz when the signal is programmed as a GPIO (when configured as an output) by BIOS.
- For GPIOs where GPIO vs. Native Mode is configured using SPI Soft Strap, the corresponding GPIO_USE_SEL bits for these GPIOs have no effect. The GPIO_USE_SEL bits for these GPIOs may change to reflect the Soft-Strap configuration even though GPIO Lockdown Enable (GLE) bit is set.
- These pins are used as Functional straps. See [Section 2.27](#) for more details.
- Once Soft-strap is set to GPIO mode, this pin will default to GP Input. When Soft-strap is SLP_LAN# usage and if Host BIOS does not configure as GP Output for SLP_LAN# control, SLP_LAN# behavior will be based on the setting of the RTC backed SLP_LAN# Default Bit (D31:F0:A4h:Bit 8).
- When the multiplexed GPIO is used as GPIO functionality, care should be taken to ensure the signal is stable in its inactive state of the native functionality, immediately after reset until it is initialized to GPIO functionality.



2.25 Manageability Signals

The following signals can be optionally used by Intel Management Engine supported applications and appropriately configured by Intel Management Engine firmware. When configured and used as a manageability function, the associated host GPIO functionality is no longer available. If the manageability function is not used in a platform, the signal can be used as a host General Purpose I/O or a native function.

Table 2-25. Manageability Signals

Name	Type	Description
SUSWARN# / SUSPWRDNACK / GPIO30 (Mobile Only)	I/O	Used by Intel® ME as either SUSWARN# in Deep S4/S5 state supported platforms or as SUSPWRDNACK in non Deep S4/S5 state supported platforms. NOTE: This signal is in the Suspend power well.
ACPRESENT / GPIO31 (Mobile Only)	I/O	Input signal from the Embedded Controller (EC) on Mobile systems to indicate AC power source or the system battery. Active High indicates AC power. NOTE: This signal is in the Deep S4/S5 power well.
SATA5GP / GPIO49 / TEMP_ALERT#	I/O	Used as an alert (active low) to indicate to the external controller (such as EC or SIO) that temperatures are out of range for the PCH or Graphics/Memory Controller or the processor core. NOTE: This signal is in the Core power well.
GPIO24 / PROC_MISSING (Desktop Only)	I/O	Used to indicate Processor Missing to the Intel Management Engine. NOTE: This signal is in the Suspend power well.

NOTE: SLP_LAN# may also be configured by Intel® ME FW in Sx/Moff. Please refer to SLP_LAN#/GPIO29 signal description for details.



2.26 Power and Ground Signals

Table 2-26. Power and Ground Signals (Sheet 1 of 2)

Name	Description
DcpRTC	Decoupling: This signal is for RTC decoupling only. This signal requires decoupling.
DcpSST	Decoupling: Internally generated 1.5 V powered off of Suspend Well. This signal requires decoupling. Decoupling is required even if this feature is not used.
DcpSus	1.05 V Suspend well power. Internal VR mode (INTVRMEN sampled high): Well generated internally. Pins should be left No Connect External VR mode (INTVRMEN sampled low): Well supplied externally. Pins should be powered by 1.05 Suspend power supply. Decoupling capacitors are required. NOTE: External VR mode applies to Mobile Only.
DcpSusByp	Internally generated 1.05 V Deep S4/S5 well power. This rail should not be supplied externally. NOTE: No decoupling capacitors should be used on this rail.
V5REF	Reference for 5 V tolerance on core well inputs. This power may be shut off in S3, S4, S5 or G3 states.
V5REF_Sus	Reference for 5 V tolerance on suspend well inputs. This power is not expected to be shut off unless the system is unplugged.
VccCore	1.05 V supply for core well logic. This power may be shut off in S3, S4, S5 or G3 states. NOTE: In external VR mode (INTVRMEN sampled low), the voltage level of VccCore may be indeterminate while DcpSus (1.05V Suspend Well Power) supply ramps and prior to PWROK assertion.
Vcc3_3	3.3 V supply for core well I/O buffers. This power may be shut off in S3, S4, S5 or G3 states.
VccASW	1.05 V supply for the Active Sleep Well. Provides power to the Intel® ME and integrated LAN. This plane must be on in S0 and other times the Intel ME or integrated LAN is used.
VccDMI	Power supply for DMI. 1.05 V or 1.0 V based on the processor VCCIO voltage. Please refer to the respective processor documentation to find the appropriate voltage level.
VccDIFFCLKN	1.05 V supply for Differential Clock Buffers. This power is supplied by the core well.
VccRTC	3.3 V (can drop to 2.0 V min. in G3 state) supply for the RTC well. This power is not expected to be shut off unless the RTC battery is removed or completely drained. NOTE: Implementations should not attempt to clear CMOS by using a jumper to pull VccRTC low. Clearing CMOS can be done by using a jumper on RTCRST# or GPI.
VccIO	1.05 V supply for core well I/O buffers. This power may be shut off in S3, S4, S5 or G3 states.
VccSus3_3	3.3 V supply for suspend well I/O buffers. This power is not expected to be shut off unless the system is unplugged.
VccSusHDA	Suspend supply for Intel® HD Audio. This pin can be either 1.5 or 3.3 V.



Table 2-26. Power and Ground Signals (Sheet 2 of 2)

Name	Description
VccVRM	1.5 V/1.8 V supply for internal PLL and VRMs
VccDFTERM	1.8 V or 3.3 V supply for DF_TVVS. This pin should be pulled up to 1.8 V or 3.3 V core.
VccADPLLA	1.05 V supply for Display PLL A Analog Power. This power is supplied by the core well.
VccADPLLB	1.05 V supply for Display PLL B Analog Power. This power is supplied by the core well.
VccADAC	3.3 V supply for Display DAC Analog Power. This power is supplied by the core well.
Vss	Grounds.
VccAClk	1.05 V Analog power supply for internal clock PLL. This power is supplied by the core well. NOTE: This pin can be left as no connect
VccAPLLEXP	1.05 V Analog Power for DMI. This power is supplied by the core well. NOTE: This pin can be left as no connect
VccAPLLDMI2	1.05 V Analog Power for internal PLL. This power is supplied by core well. NOTE: This pin can be left as no connect
VccAFDIPLL	1.05 V analog power supply for the FDI PLL. This power is supplied by core well. NOTE: This pin can be left as no connect
VccAPLLSATA	1.05 V analog power supply for SATA PLL. This power is supplied by core well. This rail requires an LC filter when power is supplied from an external VR. NOTE: This pin can be left as no connect
VccALVDS (Mobile Only)	3.3 V Analog power supply for LVDS, This power is supplied by core well.
VccTXLVDS (Mobile Only)	1.8 V I/O power supply for LVDS. This power is supplied by core well.
V_PROC_IO	Powered by the same supply as the processor I/O voltage. This supply is used to drive the processor interface signals. Please refer to the respective processor documentation to find the appropriate voltage level.
VccDSW3_3	3.3 V supply for Deep S4/S5 wells. If platform does not support Deep S4/S5 then tie to VccSus3_3.
VccSPI	3.3 V supply for SPI Controller Logic. This rail must be powered when VccASW is powered. NOTE: This rail can be optionally powered on 3.3 V Suspend power (VccSus3_3) based on platform needs.
VccSSC	1.05 V supply for Integrated Clock Spread Modulators. This power is supplied by core well.
VccClkDMI	1.05 V supply for DMI differential clock buffer



2.27 Pin Straps

The following signals are used for static configuration. They are sampled at the rising edge of PWROK to select configurations (except as noted), and then revert later to their normal usage. To invoke the associated mode, the signal should be driven at least four PCI clocks prior to the time it is sampled.

The PCH implements Soft Straps, which are used to configure specific functions within the PCH and processor very early in the boot process before BIOS or SW intervention. When Descriptor Mode is enabled, the PCH will read Soft Strap data out of the SPI device prior to the deassertion of reset to both the Intel Management Engine and the Host system. Please refer to [Section 5.24.2](#) for information on Descriptor Mode

Table 2-27. Functional Strap Definitions (Sheet 1 of 4)

Signal	Usage	When Sampled	Comment
SPKR	No Reboot	Rising edge of PWROK	The signal has a weak internal pull-down. Note that the internal pull-down is disabled after PLTRST# deasserts. If the signal is sampled high, this indicates that the system is strapped to the "No Reboot" mode (PCH will disable the TCO Timer system reboot feature). The status of this strap is readable using the NO REBOOT bit (Chipset Config Registers: Offset 3410h:Bit 5).
INIT3_3V#	Reserved	Rising edge of PWROK	This signal has a weak internal pull-up. Note that the internal pull-up is disabled after PLTRST# deasserts. NOTE: This signal should not be pulled low
GNT3# / GPIO55	Top-Block Swap Override	Rising edge of PWROK	The signal has a weak internal pull-up. Note that the internal pull-up is disabled after PLTRST# deasserts. If the signal is sampled low, this indicates that the system is strapped to the "topblock swap" mode (PCH inverts A16 for all cycles targeting BIOS space). The status of this strap is readable using the Top Swap bit (Chipset Config Registers: Offset 3414h:Bit 0). Note that software will not be able to clear the Top-Swap bit until the system is rebooted without GNT3# being pulled down.
INTVRMEN	Integrated 1.05 V VRM Enable / Disable	Always	Integrated 1.05 V VRMs is enabled when high External VR power source is used for DcpSus when sampled low. NOTES: 1. External VR powering option is for Mobile Only. Other systems should not pull the strap low. 2. See VccCore signal description for behavior when INTVRMEN is sampled low (external VR mode).

Table 2-27. Functional Strap Definitions (Sheet 2 of 4)

Signal	Usage	When Sampled	Comment															
GNT1#/GPIO51	Boot BIOS Strap bit 1 BBS1	Rising edge of PWROK	<p>This Signal has a weak internal pull-up. Note that the internal pull-up is disabled after PLTRST# deasserts. This field determines the destination of accesses to the BIOS memory range. Also controllable using Boot BIOS Destination bit (Chipset Config Registers: Offset 3410h:Bit 11). This strap is used in conjunction with Boot BIOS Destination Selection 0 strap.</p> <table border="1"> <thead> <tr> <th>Bit11</th> <th>Bit 10</th> <th>Boot BIOS Destination</th> </tr> </thead> <tbody> <tr> <td>0</td> <td>1</td> <td>Reserved</td> </tr> <tr> <td>1</td> <td>0</td> <td>PCI</td> </tr> <tr> <td>1</td> <td>1</td> <td>SPI</td> </tr> <tr> <td>0</td> <td>0</td> <td>LPC</td> </tr> </tbody> </table> <p>NOTES:</p> <ol style="list-style-type: none"> If option 00 (LPC) is selected, BIOS may still be placed on LPC, but all platforms are required to have SPI flash connected directly to the PCH's SPI bus with a valid descriptor in order to boot. Booting to PCI is intended for debut/testing only. Boot BIOS Destination Select to LPC/PCI by functional strap or using Boot BIOS Destination Bit will not affect SPI accesses initiated by Intel® ME or Integrated GbE LAN. PCI Boot BIOS destination is not supported on Mobile 	Bit11	Bit 10	Boot BIOS Destination	0	1	Reserved	1	0	PCI	1	1	SPI	0	0	LPC
Bit11	Bit 10	Boot BIOS Destination																
0	1	Reserved																
1	0	PCI																
1	1	SPI																
0	0	LPC																
SATA1GP/GPIO19	Boot BIOS Strap bit 0 BBS0	Rising edge of PWROK	<p>This Signal has a weak internal pull-up. Note that the internal pull-up is disabled after PLTRST# deasserts. This field determines the destination of accesses to the BIOS memory range. Also controllable using Boot BIOS Destination bit (Chipset Config Registers: Offset 3410h:Bit 10). This strap is used in conjunction with Boot BIOS Destination Selection 1 strap.</p> <table border="1"> <thead> <tr> <th>Bit11</th> <th>Bit 10</th> <th>Boot BIOS Destination</th> </tr> </thead> <tbody> <tr> <td>0</td> <td>1</td> <td>Reserved</td> </tr> <tr> <td>1</td> <td>0</td> <td>PCI</td> </tr> <tr> <td>1</td> <td>1</td> <td>SPI</td> </tr> <tr> <td>0</td> <td>0</td> <td>LPC</td> </tr> </tbody> </table> <p>NOTES:</p> <ol style="list-style-type: none"> If option 00 (LPC) is selected, BIOS may still be placed on LPC, but all platforms are required to have SPI flash connected directly to the PCH's SPI bus with a valid descriptor in order to boot. Booting to PCI is intended for debut/testing only. Boot BIOS Destination Select to LPC/PCI by functional strap or using Boot BIOS Destination Bit will not affect SPI accesses initiated by Management Engine or Integrated GbE LAN. PCI Boot BIOS destination is not supported on mobile. 	Bit11	Bit 10	Boot BIOS Destination	0	1	Reserved	1	0	PCI	1	1	SPI	0	0	LPC
Bit11	Bit 10	Boot BIOS Destination																
0	1	Reserved																
1	0	PCI																
1	1	SPI																
0	0	LPC																
GNT2#/GPIO53	ESI Strap (Server/Workstation Only)	Rising edge of PWROK	<p>This Signal has a weak internal pull-up. Tying this strap low configures DMI for ESI compatible operation.</p> <p>NOTES:</p> <ol style="list-style-type: none"> The internal pull-up is disabled after PLTRST# deasserts. ESI compatible mode is for server platforms only. This signal should not be pulled low for desktop and mobile. 															



Table 2-27. Functional Strap Definitions (Sheet 3 of 4)

Signal	Usage	When Sampled	Comment
HDA_SDO	Flash Descriptor Security Override / Intel ME Debug Mode	Rising edge of PWROK	Signal has a weak internal pull-down. If strap is sampled low, the security measures defined in the Flash Descriptor will be in effect (default) If sampled high, the Flash Descriptor Security will be overridden. This strap should only be asserted high using external pull-up in manufacturing/debug environments ONLY. NOTES: 1. The weak internal pull-down is disabled after PLTRST# deasserts. 2. Asserting the HDA_SDO high on the rising edge of PWROK will also halt Intel® Management Engine after chipset bring up and disable runtime Intel ME features. This is a debug mode and must not be asserted after manufacturing/debug.
DF_TVSV	DMI and FDI Tx/Rx Termination Voltage	Rising edge of PWROK	This signal has a weak internal pull-down. NOTE: The internal pull-down is disabled after PLTRST# deasserts.
GPIO28	On-Die PLL Voltage Regulator	Rising edge of RSMRST# pin	This signal has a weak internal pull-up. NOTE: The internal pull-up is disabled after RSMRST# deasserts. The On-Die PLL voltage regulator is enabled when sampled high. When sampled low the On-Die PLL Voltage Regulator is disabled.
HDA_SYNC	On-Die PLL Voltage Regulator Voltage Select	Rising edge of RSMRST# pin	This signal has a weak internal pull-down. On Die PLL VR is supplied by 1.5 V from VccVRM when sampled high, 1.8 V from VccVRM when sampled low.
GPIO15	TLS Confidentiality	Rising edge of RSMRST# pin	Low = Intel ME Crypto Transport Layer Security (TLS) cipher suite with no confidentiality High = Intel ME Crypto TLS cipher suite with confidentiality This signal has a weak internal pull-down. NOTES: 1. A strong pull-up may be needed for GPIO functionality 2. This signal must be pulled up to support Intel AMT with TLS. Intel ME configuration parameters also need to be set correctly to enable TLS.
L_DDC_DATA	LVDS Detected	Rising edge of PWROK	When '1'- LVDS is detected; When '0'- LVDS is not detected. NOTE: This signal has a weak internal pull-down. The internal pull-down is disabled after PLTRST# deasserts.
SDVO_CTRL DATA	Port B Detected	Rising edge of PWROK	When '1'- Port B is detected; When '0'- Port B is not detected This signal has a weak internal pull-down. NOTE: The internal pull-down is disabled after PLTRST# deasserts.
DDPC_CTRL DATA	Port C Detected	Rising edge of PWROK	When '1'- Port C is detected; When '0'- Port C is not detected This signal has a weak internal pull-down. NOTE: The internal pull-down is disabled after PLTRST# deasserts.
DDPD_CTRL DATA	Port D Detected	Rising edge of PWROK	When '1'- Port D is detected; When '0'- Port D is not detected This signal has a weak internal pull-down. NOTE: The internal pull-down is disabled after PLTRST# deasserts.
DSWVRMEN	Deep S4/S5 Well On-Die Voltage Regulator Enable	Always	If strap is sampled high, the Integrated Deep S4/S5 Well (DSW) On-Die VR mode is enabled.

Table 2-27. Functional Strap Definitions (Sheet 4 of 4)

Signal	Usage	When Sampled	Comment
SATA2GP/ GPIO36	Reserved	Rising edge of PWROK	This signal has a weak internal pull-down. NOTES: 1. The internal pull-down is disabled after PLTRST# deasserts. 2. This signal should not be pulled high when strap is sampled.
SATA3GP/ GPIO37	Reserved	Rising edge of PWROK	This signal has a weak internal pull-down. NOTES: 1. The internal pull-down is disabled after PLTRST# deasserts. 2. This signal should not be pulled high when strap is sampled.
GPIO8	Reserved	Rising edge of RSMRST#	This signal has a weak internal pull-up. NOTES: 1. The internal pull-up is disabled after RSMRST# deasserts. 2. This signal should not be pulled low when strap is sampled.

NOTE: See Section 3.1 for full details on pull-up/pull-down resistors.

2.28 External RTC Circuitry

The PCH implements an internal oscillator circuit that is sensitive to step voltage changes in VccRTC. Figure 2-2 shows an example schematic recommended to ensure correct operation of the PCH RTC.

Figure 2-2. Example External RTC Circuit

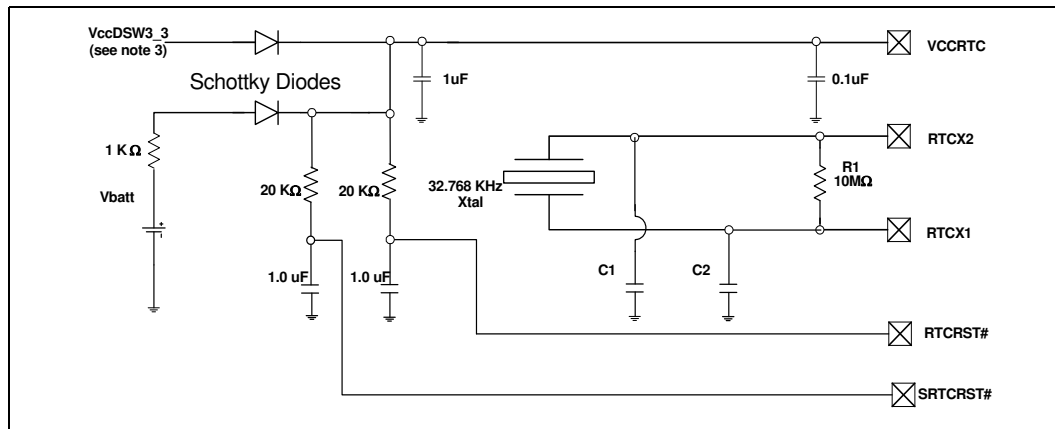

NOTES:

1. The exact capacitor values for C1 and C2 must be based on the crystal maker recommendations.
2. Reference designators are arbitrarily assigned.
3. For platforms not supporting Deep S4/S5, the VccDSW3_3 pins will be connected to the VccSus3_3 pins.
4. Vbatt is voltage provided by the RTC battery (such as coin cell).
5. VccRTC, RTCX1, RTCX2, RTCRST#, and SRTRCST# are PCH pins.
6. VccRTC powers PCH RTC well.
7. RTCX1 is the input to the internal oscillator.
8. RTCX2 is the amplified feedback for the external crystal.

§ §



3 PCH Pin States

3.1 Integrated Pull-Ups and Pull-Downs

Table 3-1. Integrated Pull-Up and Pull-Down Resistors (Sheet 1 of 2)

Signal	Resistor Type	Nominal No	tes
CL_CLK1	Pull-up/Pull-down	32/100	8, 13
CL_DATA1	Pull-up/Pull-down	32/100	8, 13
CLKOUTFLEX[3:0]/GPIO[67:64]	Pull-down	20K	1, 10
GPIO15	Pull-down	20K	3
HDA_SDIN[3:0]	Pull-down	20K	2
HDA_SYNC, HDA_SDO	Pull-down	20K	2, 5
GNT[3:1]#/GPIO[55,53,51]	Pull-up	20K	3, 6, 7
GPIO8	Pull-up	20K	3, 12
LAD[3:0]# / FWH[3:0]#	Pull-up	20K	3
LDRQ0#, LDRQ1# / GPIO23	Pull-up	20K	3
DF_TVS	Pull-down	20k	8
PME#	Pull-up	20K	3
INIT3_3V#	Pull-up	20K	3
PWRBTN#	Pull-up	20K	3
SPI_MOSI	Pull-down	20K	3, 5
SPI_MISO	Pull-up	20K	3
SPKR	Pull-down	20K	3, 9
TACH[7:0]/GPIO[71:68,7,6,1,17]	Pull-up	20K	3 (only on TACH[7:0])
USB[13:0] [P,N]	Pull-down	20K	4
DDP[D:C]_CTRLDATA	Pull-down	20K	3, 9
SDVO_CTRLDATA,L_DDC_DATA	Pull-down	20K	3, 9
SDVO_INTP, SDVO_INTN	Pull-down	50	18
SDVO_TVCLKINP, SDVO_TVCLKINN	Pull-down	50	18
SDVO_STALLP, SDVO_STALLN	Pull-down	50	18
BATLOW#/GPIO72	Pull-up	20K	3
CLKOUT_PCI[4:0]	Pull-down	20K	1, 10
GPIO27	Pull-up	20K	3, 14
JTAG_TDI, JTAG_TMS	Pull-up	20K	1, 11
JTAG_TCK	Pull-down	20K	1, 11
GPIO28	Pull-up	20K	3, 12



Table 3-1. Integrated Pull-Up and Pull-Down Resistors (Sheet 2 of 2)

Signal	Resistor Type	Nominal	Notes
SATA[3:2]GP/GPIO[37:36]	Pull-down	20K	3, 9
ACPRESENT/GPIO31	Pull-down	20K	3, 15
PCIECLKRQ5#/GPIO44	Pull-up	20K	1, 12
SST (Server/Workstation Only)	Pull-down	10K	16
PCIECLKRQ7#/GPIO46	Pull-up	20K	1, 12
SATA1GP/GPIO19	Pull-up	20K	3, 9
SUSACK#	Pull-up	20K	3
PECI	Pull-down	350	17

NOTES:

1. Simulation data shows that these resistor values can range from 10 kΩ to 40 kΩ.
2. Simulation data shows that these resistor values can range from 9 kΩ to 50 kΩ.
3. Simulation data shows that these resistor values can range from 15 kΩ to 40 kΩ.
4. Simulation data shows that these resistor values can range from 14.25 kΩ to 24.8 kΩ.
5. The pull-up or pull-down on this signal is only enabled at boot/reset for strapping function.
6. The pull-up on this signal is not enabled when PCIRST# is high.
7. The pull-up on this signal is not enabled when PWROK is low.
8. Simulation data shows that these resistor values can range from 15 kΩ to 31 kΩ.
9. The pull-up or pull-down is not active when PLTRST# is NOT asserted.
10. The pull-down is enabled when PWROK is low.
11. External termination is also required on these signals for JTAG enabling.
12. Pull-up is disabled after RSMRST# is deasserted.
13. The Controller Link Clock and Data buffers use internal pull-up or pull-down resistors to drive a logical 1 or 0.
14. Pull-up is enabled only in Deep S4/S5 state.
15. Pull-down is enabled only in Deep S4/S5 state.
16. When the interface is in BUS IDLE, the Internal Pull-down of 10 kΩ is enabled. In normal transmission, a 400 Ω pull-down takes effect, the signal will be override to logic 1 with pull-up resistor (37 Ω) to VCC 1.5 V.
17. This is a 350-Ω normal pull-down, signal will be overridden to logic 1 with pull-up resistor (31 Ω) to VCC 1.05 V.
18. Internal pull-down serves as Rx termination and is enabled after PLTRST# deasserts.



3.2 Output and I/O Signals Planes and States

Table 3.2 and Table 3-3 shows the power plane associated with the output and I/O signals, as well as the state at various times. Within the table, the following terms are used:

“High-Z”	Tri-state. PCH not driving the signal high or low.
“High”	PCH is driving the signal to a logic 1.
“Low”	PCH is driving the signal to a logic 0.
“Defined”	Driven to a level that is defined by the function or external pull-up/pull-down resistor (will be high or low).
“Undefined”	PCH is driving the signal, but the value is indeterminate.
“Running”	Clock is toggling or signal is transitioning because function not stopping.
“Off”	The power plane is off; PCH is not driving when configured as an output or sampling when configured as an input.
“Input”	PCH is sampling and signal state determined by external driver.

Note: Signal levels are the same in S4 and S5, except as noted.

PCH suspend well signal states are indeterminate and undefined and may glitch prior to RSMRST# deassertion. This does not apply to SLP_S3#, SLP_S4#, SLP_S5#, GPIO24, and GPIO29. These signals are determinate and defined prior to RSMRST# deassertion.

PCH core well signal states are indeterminate and undefined and may glitch prior to PWROK assertion. This does not apply to THRMTRIP#. This signal is determinate and defined prior to PWROK assertion.

DSW indicates PCH Deep S4/S5 Well. This state provides a few wake events and critical context to allow system to draw minimal power in S4 or S5 states.

ASW indicates PCH Active Sleep Well. This power well contains functionality associated with active usage models while the host system is in Sx.

Table 3-2. Power Plane and States for Output and I/O Signals for Desktop Configurations (Sheet 1 of 6)

Signal Name	Power Plane	During Reset ¹	Immediately after Reset ¹	S0/S1	S3	S4/S5
PCI Express*						
PETp[8:1], PETn[8:1]	Core	Low	Low ⁴	Defined	OFF	OFF
DMI						
DMI[3:0]TXP, DMI[3:0]TXN	Core	Low	Low	Defined	Off	Off
PCI Bus						
AD[31:0]	Core	Low	Low	Low	Off	Off
C/BE[3:0]#	Core	Low	Low	Low	Off	Off
DEVSEL#	Core	High-Z	High-Z	High-Z	Off	Off



Table 3-2. Power Plane and States for Output and I/O Signals for Desktop Configurations (Sheet 2 of 6)

Signal Name	Power Plane	During Reset ¹	Immediately after Reset ¹	S0/S1	S3	S4/S5
FRAME#	Core	High-Z	High-Z	High-Z	Off	Off
GNT0#, GNT[3:1]#7/ GPIO[55, 53, 51]	Core	High	High	High	Off	Off
IRDY#, TRDY#	Core	High-Z	High-Z	High-Z	Off	Off
PAR	Core	Low	Low	Low	Off	Off
PCIRST#	Suspend	Low	High	High	Low	Low
PERR#	Core	High-Z	High-Z	High-Z	Off	Off
PLOCK#	Core	High-Z	High-Z	High-Z	Off	Off
STOP#	Core	High-Z	High-Z	High-Z	Off	Off
LPC/FWH Interface						
LAD[3:0] / FWH[3:0]	Core	High	High	High	Off	Off
LFRAME# / FWH[4]	Core	High	High	High	Off	Off
INIT3_3V# ⁷	Core	High	High	High	Off	Off
SATA Interface						
SATA[5:0]TXP, SATA[5:0]TXN	Core	High-Z	High-Z	Defined	Off	Off
SATALED#	Core	High-Z	High-Z	Defined	Off	Off
SATAICOMPO	Core	High	High	Defined	Off	Off
SCLOCK/GPIO22	Core	High-Z (Input)	High-Z (Input)	Defined	Off	Off
SLOAD/GPIO38	Core	High-Z (Input)	High-Z (Input)	Defined	Off	Off
SDATAOUT[1:0]/ GPIO[48,39]	Core	High-Z	High-Z	High-Z	Off	Off
SATA3RBIAS	Core	Terminated to Vss	Terminated to Vss	Terminated to Vss	Off	Off
SATA3ICOMPO	Core	High-Z	High-Z	High-Z	Off	Off
SATA3RCOMPO	Core	High-Z	High-Z	High-Z	Off	Off
Interrupts						
PIRQ[A:D]#	Core	High-Z	High-Z	High-Z	Off	Off
PIRQ[H:E]# / GPIO[5:2]	Core	High-Z (Input)	High-Z (Input)	Defined	Off	Off
SERIRQ	Core	High-Z	High-Z	High-Z	Off	Off
USB Interface						
USB[13:0][P,N]	Suspend	Low	Low	Defined	Defined	Defined
USBRBIAS	Suspend	High-Z	High-Z	High	High	High

Table 3-2. Power Plane and States for Output and I/O Signals for Desktop Configurations (Sheet 3 of 6)

Signal Name	Power Plane	During Reset ¹	Immediately after Reset ¹	S0/S1	S3	S4/S5
Power Management						
LAN_PHY_PWR_CTRL ¹⁰ / GPIO12	Suspend	Low	Low	Defined	Defined	Defined
PLTRST#	Suspend	Low	High	High	Low	Low
SLP_A# ⁵	Suspend	Low	High	High	Defined	Defined
SLP_S3#	Suspend	Low	High	High	Low	Low
SLP_S4#	Suspend	Low	High	High	High	Defined
SLP_S5#/GPIO63	Suspend	Low	High	High	High	Defined ²
SUS_STAT#/GPIO61	Suspend	Low	High	High	Low	Low
SUSCLK/GPIO62	Suspend	Low	Running			
DRAMPWROK	Suspend	Low	High-Z	High-Z	High-Z	Low
PMSYNCH	Core	Low	Low	Defined	Off	Off
STP_PCI#/GPIO34	Core	High-Z (Input)	High-Z (Input)	Defined	Off	Off
SLP_LAN#/GPIO29 ⁸ SLP_LAN# (using soft- strap) GPIO29 (using soft- strap)	Suspend	Low High-Z	Low ⁸ High-Z	High High-Z	Defined High-Z	Defined High-Z
Processor Interface						
PROCPWRGD	Processor	Low	High	High	Off	Off
SMBus Interface						
SMBCLK, SMBDATA	Suspend	High-Z	High-Z	Defined	Defined	Defined
System Management Interface						
SML0ALERT# / GPIO60	Suspend	High-Z	High-Z ¹¹	Defined	Defined	Defined
SML0DATA	Suspend	High-Z	High-Z	Defined	Defined	Defined
SML0CLK	Suspend	High-Z	High-Z	Defined	Defined	Defined
SML1CLK/GPIO58	Suspend	High-Z	High-Z	Defined	Defined	Defined
SML1ALERT#/PCHHOT#/ GPIO74	Suspend	High-Z	High-Z	Defined	Defined	Defined
SML1DATA/GPIO75	Suspend	High-Z	High-Z	Defined	Defined	Defined
Miscellaneous Signals						
SPKR ⁷	Core	Low	Low	Defined	Off	Off
JTAG_TDO	Suspend	High-Z	High-Z	High-Z	High-Z	High-Z
GPIO24 / PROC_MISSING	Suspend	Low	Low	Defined	Defined	Defined



Table 3-2. Power Plane and States for Output and I/O Signals for Desktop Configurations (Sheet 4 of 6)

Signal Name	Power Plane	During Reset ¹	Immediately after Reset ¹	S0/S1	S3	S4/S5
Clocking Signals						
CLKOUT_ITPXDP_P CLKOUT_ITPXDP_N	Core	Running	Running	Running	Off	Off
CLKOUT_DP_P CLKOUT_DP_N	Core	Running	Running	Running	Off	Off
CLKOUT_DMI_P, CLKOUT_DMI_N	Core	Running	Running	Running	Off	Off
CLKOUT_PEG_A_P, CLKOUT_PEG_A_N	Core	Running	Running	Running	Off	Off
CLKOUT_PEG_B_P, CLKOUT_PEG_B_N	Core	Running	Running	Running	Off	Off
CLKOUT_PCI[7:0]P, CLKOUT_PCI[7:0]N	Core	Running	Running	Running	Off	Off
CLKOUT_PCI[4:0]	Core	Running	Running	Running	Off	Off
CLKOUTFLEX[3:0]/ GPIO[67:64]	Core	Low	Running	Running	Off	Off
XTAL25_OUT	Core	Running	Running	Running	Off	Off
XCLK_RCOMP	Core	High-Z	High-Z	High-Z	Off	Off
Intel® High Definition Audio Interface						
HDA_RST#	Suspend	Low	Low ³	Defined	Low	Low
HDA_SDO ⁷	Suspend	Low	Low	Defined	Low	Low
HDA_SYNC ⁷	Suspend	Low	Low	Defined	Low	Low
HDA_BCLK ¹³	Suspend	Low	Low	Low	Low	Low
UnMultiplexed GPIO Signals						
GPIO8 ⁷	Suspend	High	High	Defined	Defined	Defined
GPIO15 ⁷	Suspend	Low	Low	Defined	Defined	Defined
GPIO27 ⁷ (Non-Deep S4/ S5 mode)	DSW	High-Z	High-Z	High-Z	High-Z	High-Z
GPIO27 ⁷ (Deep S4/S5 mode)	DSW	High-Z	High-Z	High-Z	High-Z	High-Z
GPIO28 ¹²	Suspend	High	Low	Low	Low	Low
GPIO32	Core	High	High	Defined	Off	Off
GPIO57	Suspend	Low	High-Z (Input)	Defined	Defined	Defined
GPIO72 ⁹	Suspend	High	High	Defined	Defined	Defined
Multiplexed GPIO Signals used as GPIO only						
GPIO0	Core	High-Z (Input)	High-Z (Input)	Defined	Off	Off
GPIO13 ⁹	Suspend	High-Z	High-Z	High-Z	High-Z	High-Z
GPIO30 ⁹	Suspend	High-Z (Input)	High-Z (Input)	Defined	Defined	Defined

Table 3-2. Power Plane and States for Output and I/O Signals for Desktop Configurations (Sheet 5 of 6)

Signal Name	Power Plane	During Reset ¹	Immediately after Reset ¹	S0/S1	S3	S4/S5
GPIO31 ⁹ (Non Deep-S4/S5 mode)	DSW	High-Z (Input)	High-Z (Input)	Defined	Defined	Defined
GPIO31 ⁹ (Deep-S4/S5 mode)	DSW	High-Z (Input)	High-Z (Input)	Defined	Defined	Defined
GPIO33 ⁹	Core	High	High	High	Off	Off
GPIO35 / NMI# (NMI# is Server/Workstation Only)	Core	Low	Low	Defined	Off	Off
SPI Interface						
SPI_CS0#	ASW	High ¹²	High	Defined	Defined	Defined
SPI_CS1#	ASW	High ¹²	High	Defined	Defined	Defined
SPI_MOSI	ASW	Low ¹²	Low	Defined	Defined	Defined
SPI_CLK	ASW	Low ¹²	Low	Running	Defined	Defined
Controller Link						
CL_CLK1 ⁶	Suspend	High/Low ¹⁵	High/Low ¹⁵	Defined	Defined	Defined
CL_DATA1 ⁶	Suspend	High/Low ¹⁵	High/Low ¹⁵	Defined	Defined	Defined
CL_RST1# ⁶	Suspend	Low	High	High	High	High
Thermal Signals						
PWM[3:0] (Server/Workstation Only)	Core	Low	Low	Defined	Off	Off
SST (Server/Workstation Only)	Suspend	Low	Low	Defined	Off	Off
PECI	Processor	Low	Low	Defined	Off	Off
Analog Display / CRT DAC Signals						
VGA_RED, VGA_GREEN, VGA_BLUE	Core	High-Z	High-Z	High-Z	Off	Off
DAC_IREF	Core	High-Z	Low	Low	Off	Off
VGA_HSYNC	Core	Low	Low	Low	Off	Off
VGA_VSYNC	Core	Low	Low	Low	Off	Off
VGA_DDC_CLK	Core	High-Z	High-Z	High-Z	Off	Off
VGA_DDC_DATA	Core	High-Z	High-Z	High-Z	Off	Off
VGA_IRTN	Core	High-Z	High-Z	High-Z	Off	Off
Intel® Flexible Display Interface						
FDI_FSYNC[1:0]	Core	High-Z	High-Z	High-Z	Off	Off
FDI_LSYNC[1:0]	Core	High-Z	High-Z	High-Z	Off	Off
FDI_INT	Core	High-Z	High-Z	High-Z	Off	Off



Table 3-2. Power Plane and States for Output and I/O Signals for Desktop Configurations (Sheet 6 of 6)

Signal Name	Power Plane	During Reset ¹	Immediately after Reset ¹	S0/S1	S3	S4/S5
Digital Display Interface						
DDP[D:B]_[3:0]P, DDP[D:B]_[3:0]N	Core	Low	Low	Defined	Off	Off
DDP[D:B]_AUXP, DDP[D:B]_AUXN	Core	Low	Low	Defined	Off	Off
SDVO_CTRLCLK	Core	High-Z	High-Z	Defined	Off	Off
SDVO_CTRLDATA	Core	Low	High-Z	Defined	Off	Off
DDPC_CTRLCLK, DDPD_CTRLCLK	Core	High-Z	High-Z	Defined	Off	Off
DDPC_CTRLDATA DDPD_CTRLDATA	Core	Low	High-Z	Defined	Off	Off

NOTES:

1. The states of Core and processor signals are evaluated at the times During PLTRST# and Immediately after PLTRST#. The states of the Controller Link signals are taken at the times during CL_RST1# and Immediately after CL_RST1#. The states of the Suspend signals are evaluated at the times during RSMRST# and Immediately after RSMRST#, with an exception to GPIO signals; refer to [Section 2.24](#) for more details on GPIO state after reset. The states of the HDA signals are evaluated at the times During HDA_RST# and Immediately after HDA_RST#.
2. SLP_S5# signal will be high in the S4 state and low in the S5 state.
3. Low until Intel High Definition Audio Controller Reset bit set (D27:F0:Offset HDBAR+08h:bit 0), at which time HDA_RST# will be High and HDA_BIT_CLK will be Running.
4. PETp/n[8:1] low until port is enabled by software.
5. The SLP_A# state will be determined by Intel ME Policies.
6. The state of signals in S3-5 will be defined by Intel ME Policies.
7. This signal is sampled as a functional strap during reset. Refer to Functional straps definition table for usage.
8. SLP_LAN# behavior after reset is dependent on value of SLP_LAN# default value bit. A soft-strap is used to select between SLP_LAN# and GPIO usage. When strap is set to 0 (default), pin is used as SLP_LAN#; when soft-strap is set to 1, pin is used as GPIO29.
9. Native functionality multiplexed with these GPIOs are not used in Desktop Configurations.
10. Native/GPIO functionality controlled using soft straps. Default to Native functionality until soft straps are loaded.
11. State of the pins depend on the source of VccASW power.
12. Pin is tri-stated prior to APWROK assertion during Reset.
13. When Controller Reset Bit of Global Control Register (D27:F0 Offset HDBAR 08h bit 0) gets set, this pin will start toggling.
14. Not all signals or pin functionalities may be available on a given SKU. See [Section 1.3](#) and [Chapter 2](#) for details.
15. Controller Link Clock and Data buffers use internal pull-up and pull-down resistors to drive a logical 1 or a 0.

Table 3-3. Power Plane and States for Output and I/O Signals for Mobile Configurations (Sheet 1 of 6)

Signal Name	Power Plane	During Reset ¹	Immediately after Reset ¹	C-x states	S0/S1	S3	S4/S5
PCI Express*							
PET[8:1]p, PET[8:1]n	Core	Low	Low ⁴	Defined	Defined	Off	Off
DMI							
DMI[3:0]TXP, DMI[3:0]TXN	Core	Low	Low	Defined	Defined	Off	Off
LPC/FWH Interface							
LAD[3:0] / FWH[3:0]	Core	High	High	High	High	Off	Off
LFRAME# / FWH[4]	Core	High	High	High	High	Off	Off
INIT3_3V# ⁷	Core	High	High	High	High	Off	Off
SATA Interface							
SATA[5:0]TXP, SATA[5:0]TXN	Core	High-Z	High-Z	Defined	Defined	Off	Off
SATALED#	Core	High-Z	High-Z	Defined	Defined	Off	Off
SATAICOMPO	Core	High-Z	High-Z	Defined	Defined	Off	Off
SCLOCK/GPIO22	Core	High-Z (Input)	High-Z (Input)	Defined	Defined	Off	Off
SLOAD/GPIO38	Core	High-Z (Input)	High-Z (Input)	Defined	Defined	Off	Off
SDATAOUT[1:0]/ GPIO[48,39]	Core	High-Z (Input)	High-Z (Input)	Defined	Defined	Off	Off
SATA3RBIAS	Core	Terminated to Vss	Terminated to Vss	Terminated to Vss	Terminated to Vss	Off	Off
SATA3ICOMPO	Core	High-Z	High-Z	High-Z	High-Z	Off	Off
SATA3RCOMPO	Core	High-Z	High-Z	High-Z	High-Z	Off	Off
Interrupts							
PIRQ[A:D]#	Core	High-Z	High-Z	Defined	Defined	Off	Off
PIRQ[H:E]# / GPIO[5:2]	Core	High-Z (Input)	High-Z (Input)	Defined	Defined	Off	Off
SERIRQ	Core	High-Z	High-Z	Running	High-Z	Off	Off
USB Interface							
USB[13:0][P,N]	Suspend	Low	Low	Defined	Defined	Defined	Defined
USBRBIAS	Suspend	High-Z	High-Z	Defined	Defined	Defined	Defined



Table 3-3. Power Plane and States for Output and I/O Signals for Mobile Configurations (Sheet 2 of 6)

Signal Name	Power Plane	During Reset ¹	Immediately after Reset ¹	C-x states	S0/S1	S3	S4/S5
Power Management							
CLKRUN# ¹⁹	Core	Low	Low	Defined	Defined	Off	Off
PLTRST#	Suspend	Low	High	High	High	Low	Low
SLP_A# ⁵	Suspend	Low	High	High	High	Defined	Defined
SLP_S3#	Suspend	Low	High	High	High	Low	Low
SLP_S4#	Suspend	Low	High	High	High	High	Defined
SLP_S5#/GPIO63	Suspend	Low	High	High	High	High	Defined ²
SUS_STAT#/GPIO61	Suspend	Low	High	High	High	Low	Low
SUSCLK/GPIO62	Suspend	Low	Running				
SUSWARN#/ SUSPWRDNACK/ GPIO30 (note 20)	Suspend	0	1	Defined	Defined	Defined	Defined
SUSWARN#/ SUSPWRDNACK/ GPIO30 (note 21)	Suspend	0	1	1	1	1	1
DRAMPWROK	Suspend	Low	High-Z	High-Z	High-Z	High-Z	Low
LAN_PHY_PWR_CTRL 9/GPIO12	Suspend	Low	Low	Defined	Defined	Defined	Defined
PMSYNCH	Core	Low	Low	Defined/ Low ¹⁰	Defined	Off	Off
STP_PCI#/GPIO34	Core	High-Z (Input)	High-Z (Input)	Defined	Defined	Off	Off
SLP_LAN# ¹⁴ /GPIO29 SLP_LAN# (using soft-strap) GPIO29 (using soft- strap)	Suspend	Low Low	Low ¹⁴ High-Z	High High-Z	High High-Z	Defined High-Z	Defined High-Z
Processor Interface							
PROCPWRGD	Processor	Low	High	High	High	Off	Off
SMBus Interface							
SMBCLK, SMBDATA	Suspend	High-Z	High-Z	Defined	Defined	Defined	Defined

Table 3-3. Power Plane and States for Output and I/O Signals for Mobile Configurations (Sheet 3 of 6)

Signal Name	Power Plane	During Reset ¹	Immediately after Reset ¹	C-x states	S0/S1	S3	S4/S5
System Management Interface							
SML0ALERT#/GPIO60	Suspend	High-Z	High-Z	Defined	Defined	Defined	Defined
SML0DATA	Suspend	High-Z	High-Z	Defined	Defined	Defined	Defined
SML0CLK	Suspend	High-Z	High-Z	Defined	Defined	Defined	Defined
SML1CLK/GPIO58	Suspend	High-Z	High-Z	Defined	Defined	Defined	Defined
SML1ALERT#/PCHHOT#/GPIO74	Suspend	High-Z	High-Z	Defined	Defined	Defined	Defined
SML1DATA/GPIO75	Suspend	High-Z	High-Z	Defined	Defined	Defined	Defined
Miscellaneous Signals							
SPKR ⁷	Core	Low	Low	Defined	Defined	Off	Off
JTAG_TDO	Suspend	High-Z	High-Z	High-Z	High-Z	High-Z	High-Z
Clocking Signals							
CLKOUT_ITPXD_P, CLKOUT_ITPXD_N	Core	Running	Running	Running	Running	Off	Off
CLKOUT_DP_P, CLKOUT_DP_N	Core	Running	Running	Running	Running	Off	Off
CLKOUT_DMI_P, CLKOUT_DMI_N	Core	Running	Running	Running	Running	Off	Off
XTAL25_OUT	Core	High-Z	High-Z	High-Z	High-Z	Off	Off
XCLK_RCOMP	Core	High-Z	High-Z	High-Z	High-Z	Off	Off
CLKOUT_PEG_A_P, CLKOUT_PEG_A_N	Core	Running	Running	Running	Running	Off	Off
CLKOUT_PEG_B_P, CLKOUT_PEG_B_N	Core	Running	Running	Running	Running	Off	Off
CLKOUT_PCIE[7:0] P, CLKOUT_PCIE[7:0] N	Core	Running	Running	Running	Running	Off	Off
CLKOUT_PCI[4:0]	Core	Running	Running	Running	Running	Off	Off
CLKOUTFLEX[3:0]/GPIO[67:64]	Core	Low	Running	Running/Low	Running	Off	Off
Intel® High Definition Audio Interface							
HDA_RST#	Suspend	Low	Low ³	Defined	Defined	Low	Low
HDA_SDO ⁷	Suspend	Low	Low	Low	Low	Low	Low
HDA_SYNC ⁷	Suspend	Low	Low	Low	Low	Low	Low
HDA_BCLK ²²	Suspend	Low	Low	Low	Low	Low	Low
HDA_DOCK_EN#/GPIO33	Core	High	High ¹¹	High ¹¹	High ¹¹	Off	Off
HDA_DOCK_RST#/GPIO13	Suspend	High-Z	High-Z	High-Z	High-Z	High-Z	High-Z

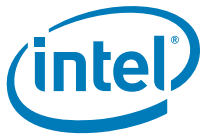

Table 3-3. Power Plane and States for Output and I/O Signals for Mobile Configurations (Sheet 4 of 6)

Signal Name	Power Plane	During Reset ¹	Immediately after Reset ¹	C-x states	S0/S1	S3	S4/S5
UnMultiplexed GPIO Signals							
GPIO8 ⁷	Suspend	High	High	Defined	Defined	Defined	Defined
GPIO15 ⁷	Suspend	Low	Low	Defined	Defined	Defined	Defined
GPIO24	Suspend	Low	Low	Defined	Defined	Defined	Defined
GPIO27 ⁷ (Non-Deep S4/S5 mode)	DSW	High-Z	High-Z	High-Z	High-Z	High-Z	High-Z
GPIO27 ⁷ (Deep S4/S5 mode)	DSW	High-Z	High-Z	High-Z	High-Z	High-Z	High-Z
GPIO28	Suspend	High	Low	Low	Low	Low	Low
GPIO57	Suspend	Low	High-Z (Input)	Defined	Defined	Defined	Defined
Multiplexed GPIO Signals used as GPIO only							
GPIO0	Core	High-Z (Input)	High-Z (Input)	Defined	Defined	Off	Off
GPIO[17,7,6,1] ⁸	Core	High-Z	High-Z	High-Z	High-Z	Off	Off
GPIO35	Core	Low	Low	Defined	Defined	Off	Off
GPIO50	Core	High-Z	High-Z	High-Z	High-Z	Off	Off
GPIO[55,53,51]	Core	High	High	High	High	Off	Off
GPIO52	Core	High-Z	High-Z	High-Z	High-Z	Off	Off
GPIO54	Core	High-Z	High-Z	High-Z	High-Z	Off	Off
GPIO[71:68]	Core	High-Z	High-Z	High-Z	High-Z	Off	Off
SPI Interface							
SPI_CS0#	ASW	High ¹⁸	High	Defined	Defined	Defined	Defined
SPI_CS1#	ASW	High ¹⁸	High	Defined	Defined	Defined	Defined
SPI_MOSI	ASW	Low ¹⁸	Low	Defined	Defined	Defined	Defined
SPI_CLK	ASW	Low ¹⁸	Low	Running	Running	Defined	Defined
Controller Link							
CL_CLK1 ⁶	Suspend	High/Low ¹³	High/Low ¹³	Defined	Defined	Defined	Defined
CL_DATA1 ⁶	Suspend	High/Low ¹³	High/Low ¹³	Defined	Defined	Defined	Defined
CL_RST1# ⁶	Suspend	Low	High	Defined	High	High	High

Table 3-3. Power Plane and States for Output and I/O Signals for Mobile Configurations (Sheet 5 of 6)

Signal Name	Power Plane	During Reset ¹	Immediately after Reset ¹	C-x states	S0/S1	S3	S4/S5
LVDS Signals							
LVDSA_DATA[3:0], LVDSA_DATA#[3:0]	Core	High-Z	High-Z	Defined/ High-Z ¹²	Defined/ High-Z ¹²	Off	Off
LVDSA_CLK, LVDSA_CLK#	Core	High-Z	High-Z	Defined/ High-Z ¹²	Defined/ High-Z ¹²	Off	Off
LVDSB_DATA[3:0], LVDSB_DATA#[3:0]	Core	High-Z	High-Z	Defined/ High-Z ¹²	Defined/ High-Z ¹²	Off	Off
LVDSB_CLK, LVDSB_CLK#	Core	High-Z	High-Z	Defined/ High-Z ¹²	Defined/ High-Z ¹²	Off	Off
L_DDC_CLK	Core	High-Z	High-Z	High-Z	High-Z	Off	Off
L_DDC_DATA	Core	Low	High-Z	High-Z	High-Z	Off	Off
L_VDD_EN	Core	Low	Low	Low/ High-Z ¹²	Low/ High-Z ¹²	Off	Off
L_BKLTEN	Core	Low	Low	Low/ High-Z ¹²	Low/ High-Z ¹²	Off	Off
L_BKLTCTL	Core	Low	Low	Low/ High-Z ¹²	Low/ High-Z ¹²	Off	Off
L_CTRL_CLK	Core	High-Z	High-Z	High-Z	High-Z	Off	Off
L_CTRL_DATA	Core	High-Z	High-Z	High-Z	High-Z	Off	Off
LVD_VBG, LVD_VREFH, LVD_VREFL	Core	High-Z	High-Z	High-Z	High-Z	Off	Off
Analog Display / CRT DAC Signals							
CRT_RED, CRT_GREEN, CRT_BLUE	Core	High-Z	High-Z	Defined	Defined	Off	Off
DAC_IREF	Core	High-Z	Low	Low	Low	Off	Off
CRT_HSYNC	Core	Low	Low	Low	Low	Off	Off
CRT_VSYNC	Core	Low	Low	Low	Low	Off	Off
CRT_DDC_CLK	Core	High-Z	High-Z	High-Z	High-Z	Off	Off
CRT_DDC_DATA	Core	High-Z	High-Z	High-Z	High-Z	Off	Off
CRT_IRTN	Core	High-Z	High-Z	High-Z	High-Z	Off	Off
Intel® Flexible Display Interface							
FDI_FSYNC[1:0]	Core	High-Z	High-Z	Defined	Defined	Off	Off
FDI_LSYNC[1:0]	Core	High-Z	High-Z	Defined	Defined	Off	Off
FDI_INT	Core	High-Z	High-Z	Defined	Defined	Off	Off



Table 3-3. Power Plane and States for Output and I/O Signals for Mobile Configurations (Sheet 6 of 6)

Signal Name	Power Plane	During Reset ¹	Immediately after Reset ¹	C-x states	S0/S1	S3	S4/S5
Digital Display Interface							
DDP[D:B]_[3:0]P, DDP[D:B]_[3:0]N,	Core	Low	Low	Defined	Defined	Off	Off
DDP[D:B]_AUXP, DDP[D:B]_AUXN	Core	Low	Low	Defined	Defined	Off	Off
SDVO_CTRLCLK	Core	High-Z	High-Z	Defined	Defined	Off	Off
SDVO_CTRLDATA	Core	Low	High-Z	Defined	Defined	Off	Off
DDPC_CTRLCLK, DDPD_CTRLCLK	Core	High-Z	High-Z	Defined	Defined	Off	Off
DDPC_CTRLDATA, DDPD_CTRLDATA	Core	Low	High-Z	Defined	Defined	Off	Off

NOTES:

1. The states of Core and processor signals are evaluated at the times During PLTRST# and Immediately after PLTRST#. The states of the Controller Link signals are taken at the times During CL_RST1# and Immediately after CL_RST1#. The states of the Suspend signals are evaluated at the times During RSMRST# and Immediately after RSMRST#, with an exception to GPIO signals; refer to [Section 2.24](#) for more details on GPIO state after reset. The states of the HDA signals are evaluated at the times During HDA_RST# and Immediately after HDA_RST#.
2. SLP_S5# signal will be high in the S4 state and low in the S5 state.
3. Low until Intel® High Definition Audio Controller Reset bit set (D27:F0:Offset HDBAR+08h:bit 0), at which time HDA_RST# will be High and HDA_BIT_CLK will be Running.
4. PEPn[n[8:1] low until port is enabled by software.
5. The SLP_A# state will be determined by Intel ME Policies.
6. The state of signals in S3-5 will be defined by Intel ME Policies.
7. This signal is sampled as a functional strap During Reset. Refer to Functional straps definition table for usage.
8. Native functionality multiplexed with these GPIOs is not utilized in Mobile Configurations.
9. Native/GPIO functionality controlled using soft straps. Default to Native functionality until soft straps are loaded.
10. This pin will be driven to a High when Dock Attach bit is set (Docking Control Register D27:F0 Offset 4Ch)
11. This pin will be driven to a Low when Dock Attach bit is set (Docking Control Register D27:F0 Offset 4Ch)
12. PCH tri-states these signals when LVDS port is disabled.
13. Controller Link Clock and Data buffers use internal pull-up and pull-down resistors to drive a logical 1 or a 0.
14. SLP_LAN# behavior after reset is dependent on value of SLP_LAN# default value bit. A soft-strap is used to select between SLP_LAN# and GPIO usage. When strap is set to 0 (default), pin is used as SLP_LAN#, when soft-strap is set to 1, pin is used as GPIO29.
15. State of the pins depend on the source of VccASW power.
16. Pin state reflected when SPI2 enable RTC power backed soft strap is enabled, for Mobile configurations using a Finger-Print Sensor device. When soft strap is not enabled, signal defaults to GP Input.
17. Based on Intel ME wake events and Intel ME state. SUSWRDNACK is the default mode of operation. If system supports Deep S4/S5, subsequent boots will default to SUSWRN#
18. Pins are tri-stated prior to APWROK assertion During Reset.
19. CLKRUN# is driven to a logic 1 During Reset for Mobile configurations (default is native function) to ensure that PCI clocks can toggle before devices come out of Reset.



20. Pin-state indicates SUSWRDNACK in Non-Deep S4/S5, Deep S4/S5 after RTC power failure.
21. Pin-state indicates SUSWARN# in Deep S4/S5 supported platforms.
22. When Controller Reset Bit of Global Control Register (D27:F0 Offset HDBAR 08h Bit 0) gets set, this pin will start toggling.
23. Not all signals or pin functionalities may be available on a given SKU. See [Section 1.3](#) and [Chapter 2](#) for details.

3.3 Power Planes for Input Signals

[Table 3-4](#) and [Table 3-5](#) shows the power plane associated with each input signal, as well as what device drives the signal at various times. Valid states include:

High

Low

Static: Will be high or low, but will not change

Driven: Will be high or low, and is allowed to change

Running: For input clocks

PCH suspend well signal states are indeterminate and undefined and may glitch prior to RSMRST# deassertion. This does not apply to SLP_S3#, SLP_S4#, and SLP_S5#. These signals are determinate and defined prior to RSMRST# deassertion.

PCH core well signal states are indeterminate and undefined and may glitch prior to PWROK assertion. This does not apply to THRMTRIP#. This signal is determinate and defined prior to PWROK assertion.

DSW indicates PCH Deep S4/S5 Well. This state provides a few wake events and critical context to allow system to draw minimal power in S4 or S5 states.

ASW indicates PCH Active Sleep Well. This power well contains functionality associated with active usage models while the host system is in Sx.

Table 3-4. Power Plane for Input Signals for Desktop Configurations (Sheet 1 of 3)

Signal Name	Power Well	Driver During Reset	S0/S1	S3	S4/S5
DMI					
DMI[3:0]RXP, DMI[3:0]RXN	Core	Processor	Driven	Off	Off
PCI Express*					
PER[8:1]p, PERn[8:1]n	Core	PCI Express Device	Driven	Off	Off
PCI Bus					
REQ0#, REQ1# / GPIO50 ¹ REQ2# / GPIO52 ¹ REQ3# / GPIO54 ¹	Core	External Pull-up	Driven	Off	Off
PME#	Suspend	Internal Pull-up	Driven	Driven	Driven
SERR#	Core	PCI Bus Peripherals	Driven	Off	Off
LPC Interface					
LDRQ0#	Core	LPC Devices	Driven	Off	Off
LDRQ1# / GPIO23 ¹	Core	LPC Devices	Driven	Off	Off



Table 3-4. Power Plane for Input Signals for Desktop Configurations (Sheet 2 of 3)

Signal Name	Power Well	Driver During Reset	S0/S1	S3	S4/S5
SATA Interface					
SATA[5:0]RXP, SATA[5:0]RXN	Core	SATA Drive	Driven	Off	Off
SATAICOMPI	Core	High-Z	Driven	Off	Off
SATA4GP/GPIO16 ¹	Core	External Device or External Pull-up/Pull-down	Driven	Off	Off
SATA5GP/GPIO49 ¹ / TEMP_ALERT#	Core	External Device or External Pull-up/Pull-down	Driven	Off	Off
SATA0GP / GPIO[21] ¹	Core	External Device or External Pull-up/Pull-down	Driven	Off	Off
SATA1GP/GPIO19	Core	Internal Pull-up	Driven	Off	Off
SATA[3:2]GP/ GPIO[37:36]	Core	Internal Pull-down	Driven	Off	Off
SATA3COMPI	Core	External Pull-up	Driven	Off	Off
USB Interface					
OC[7:0]#/ GPIO[14,10,9,43:40,59] ¹	Suspend	External Pull-ups	Driven	Driven	Driven
USBRBIAS#	Suspend	External Pull-down	Driven	Driven	Driven
Power Management					
APWROK	Suspend	External Circuit	High	Driven	Driven
PWRBTN#	DSW	Internal Pull-up	Driven	Driven	Driven
PWROK	RTC	External Circuit	Driven	Driven	Driven
DPWROK	RTC	External Circuit	Driven	Driven	Driven
RI#	Suspend	Serial Port Buffer	Driven	Driven	Driven
RSMRST#	RTC	External RC Circuit	High	High	High
SYS_RESET#	Core	External Circuit	Driven	Off	Off
SYS_PWROK	Suspend	External Circuit	High	Driven	Driven
THRMTRIP#	Core (Processor)	External Thermal Sensor	Driven	Off	Off
WAKE#	Suspend	External Pull-up	Driven	Driven	Driven
Processor Interface					
A20GATE	Core	External Micro controller	Static	Off	Off
RCIN#	Core	External Micro controller	High	Off	Off
System Management Interface					
SMBALERT# / GPIO11	Suspend	External Pull-up	Driven	Driven	Driven
INTRUDER#	RTC	External Switch	Driven	Driven	Driven
JTAG Interface					
JTAG_TDI ³	Suspend	Internal Pull-up	High	High	High
JTAG_TMS ³	Suspend	Internal Pull-up	High	High	High
JTAG_TCK ³	Suspend	Internal pull-down	Low	Low	Low

**Table 3-4. Power Plane for Input Signals for Desktop Configurations (Sheet 3 of 3)**

Signal Name	Power Well	Driver During Reset	S0/S1	S3	S4/S5
Miscellaneous Signals					
INTVRMEN ²	RTC	External Pull-up	High	High	High
RTCST#	RTC	External RC Circuit	High	High	High
SRTCST#	RTC	External RC Circuit	High	High	High
Digital Display Interface					
DDP[B:C:D]_HPD	Core	External Pull-down	Driven	Off	Off
SDVO_INTP, SDVO_INTN	Core	SDVO controller device	Driven	Off	Off
SDVO_TVCLKINP, SDVO_TVCLKINN	Core	SDVO controller device	Driven	Off	Off
SDVO_STALLP, SDVO_STALLN	Core	SDVO controller device	Driven	Off	Off
Intel® Flexible Display Interface					
FDI_RXP[7:0], FDI_RXN[7:0]	Core	Processor	Driven	Off	Off
Clock Interface					
CLKIN_SATA_N, CLKIN_SATA_P	Core	External pull-down	Low	Off	Off
CLKIN_DOT_96P, CLKIN_DOT_96N	Core	External pull-down	Low	Off	Off
CLKIN_DMI_P, CLKIN_DMI_N	Core	External pull-down	Low	Off	Off
CLKIN_PCILoopBACK	Core	Clock Generator	Running	Off	Off
PCIECLKRQ[7:5]#/ GPIO[46:44] ¹	Suspend	External Pull-up	Driven	Driven	Driven
PCIECLKRQ2#/GPIO20 ¹ / SMI# (SMI# is Server/ Workstation Only)	Core	External Pull-up	Driven	Off	Off
REFCLK14IN	Core	External Pull-down	Low	Off	Off
XTAL25_IN	Core	Clock Generator	High-Z	High-Z	High-Z
Intel® High Definition Audio Interface					
SPI Interface					
SPI_MISO	ASW	Internal Pull-up	Driven	Driven	Driven
Thermal (Server/Workstation Only)					
TACH[7:0]/ GPIO[71:68,7,6,1,17] ¹	Core	Internal Pull-up	Driven	Off	Off

NOTE:

1. These signals can be configured as outputs in GPIO mode.
2. This signal is sampled as a functional strap during Reset. Refer to Functional straps definition table for usage.
3. External termination is also required for JTAG enabling.
4. Not all signals or pin functionalities may be available on a given SKU. See [Section 1.3](#) and [Chapter 2](#) for details.



Table 3-5. Power Plane for Input Signals for Mobile Configurations (Sheet 1 of 3)

Signal Name	Power Well	Driver During Reset	C-x states	S0/S1	S3	S4/S5
DMI						
DMI[3:0]RXP, DMI[3:0]RXN	Core	Processor	Driven	Driven	Off	Off
PCI Express*						
PER[8:1]p, PER[8:1]n	Core	PCI Express* Device	Driven	Driven	Off	Off
LPC Interface						
LDRQ0#	Core	Internal Pull-up	Driven	High	Off	Off
LDRQ1# / GPIO23 ¹	Core	Internal Pull-up	Driven	High	Off	Off
SATA Interface						
SATA[5:0]RXP, SATA[5:0]RXN	Core	SATA Drive	Driven	Driven	Off	Off
SATAICOMPI	Core	High-Z	High-Z	Defined	Off	Off
SATA4GP/GPIO16 ¹	Core	External Device or External Pull-up/Pull-down	Driven	Driven	Off	Off
SATA5GP/GPIO49 ¹ / TEMP_ALERT#	Core	External Device or External Pull-up/Pull-down	Driven	Driven	Off	Off
SATA[0]GP / GPIO[21] ¹	Core	External Device or External Pull-up/Pull-down	Driven	Driven	Off	Off
SATA1GP/GPIO19	Core	Internal Pull-up	Driven	Driven	Off	Off
SATA[3:2]GP/ GPIO[37:36]	Core	Internal Pull-down	Driven	Driven	Off	Off
SATA3COMPI	Core	External Pull-up	Driven	Driven	Off	Off
USB Interface						
OC[7:0]#/ GPIO[14,10,9,43:40, 59]	Suspend	External Pull-ups	Driven	Driven	Driven	Driven
USBRBIAS#	Suspend	External Pull-down	Driven	Driven	Driven	Driven
Power Management						
ACPRESENT (Mobile Only) /GPIO31 ¹ (Non- Deep S4/S5 mode)	DSW	External Microcontroller	Driven	Driven	Driven	Driven
ACPRESENT (Mobile Only) /GPIO31 ¹ (Deep S4/S5 mode)	DSW	External Microcontroller	Driven	Driven	Driven	Driven
BATLOW# (Mobile Only) /GPIO72 ¹	Suspend	External Pull-up	High	High	Driven	Driven
APWROK	Suspend	External Circuit	Driven	Driven	Driven	Driven
PWRBTN#	DSW	Internal Pull-up	Driven	Driven	Driven	Driven
PWROK	RTC	External Circuit	Driven	Driven	Off	Off

**Table 3-5. Power Plane for Input Signals for Mobile Configurations (Sheet 2 of 3)**

Signal Name	Power Well	Driver During Reset	C-x states	S0/S1	S3	S4/S5
RI#	Suspend	Serial Port Buffer	Driven	Driven	Driven	Driven
RSMRST#	RTC	External RC Circuit	High	High	High	High
SYS_RESET#	Core	External Circuit	Driven	Driven	Off	Off
THRMTRIP#	CORE (Processor)	Thermal Sensor	Driven	Driven	Off	Off
WAKE#	Suspend	External Pull-up	Driven	Driven	Driven	Driven
Processor Interface						
A20GATE	Core	External Microcontroller	Static	Static	Off	Off
RCIN#	Core	External Microcontroller	High	High	Off	Off
System Management Interface						
SMBALERT# / GPIO11	Suspend	External Pull-up	Driven	Driven	Driven	Driven
INTRUDER#	RTC	External Switch	Driven	Driven	High	High
JTAG Interface						
JTAG_TDI	Suspend	Internal Pull-up ⁴	High	High	High	High
JTAG_TMS	Suspend	Internal Pull-up ⁴	High	High	High	High
JTAG_TCK	Suspend	Internal Pull-down ⁴	Low	Low	Low	Low
Miscellaneous Signals						
INTVRMEN ²	RTC	External Pull-up or Pull-down	High	High	High	High
RTCRST#	RTC	External RC Circuit	High	High	High	High
SRTCST#	RTC	External RC Circuit	High	High	High	High
Intel® High Definition Audio Interface						
HDA_SDIN[3:0]	Suspend	Intel® High Definition Audio Codec	Driven	Low	Low	Low
SPI Interface						
SPI_MISO	ASW	Internal Pull-up	Driven	Driven	Driven	Driven



Table 3-5. Power Plane for Input Signals for Mobile Configurations (Sheet 3 of 3)

Signal Name	Power Well	Driver During Reset	C-x states	S0/S1	S3	S4/S5
Clock Interface						
CLKIN_DMI_P, CLKIN_DMI_N	Core	External pull-down	Low	Low	Off	Off
CLKIN_SATA_N/ CLKIN_SATA_P	Core	External pull-down	Low	Low	Off	Off
CLKIN_DOT_96P, CLKIN_DOT_96N	Core	External pull-down	Low	Low	Off	Off
CLKIN_PCILoopback	Core	Clock Generator	Running	Running	Off	Off
PCIECLKRQ[7:3]#/ GPIO[46:44,26:25] ¹ , PCIECLKRQ0#/ GPIO73 ¹	Suspend	External Pull-up	Driven	Driven	Driven	Driven
PCIECLKRQ[2:1]#/ GPIO[20:18] ¹	Core	External Pull-up	Driven	Driven	Off	Off
PEG_A_CLKRQ#/ GPIO47 ¹ , PEG_B_CLKRQ#/ GPIO56 ¹	Suspend	External Pull-up	Driven	Driven	Driven	Driven
XTAL25_IN	Core	Clock Generator	High-Z	High-Z	Off	Off
REFCLK14IN	Core	External pull-down	Low	Low	Off	Off
CLKIN_PCILoopback	Core	Clock Generator	High-Z	High-Z	Off	Off
Intel® Flexible Display Interface						
FDI_RXP[7:0], FDI_RXN[7:0]	Core	Processor	Driven	Driven	Off	Off
Digital Display Interface						
DDP[B:C:D]_HPD	Core	External Pull-down	Driven	Driven	Off	Off
SDVO_INTN, SDVO_INTN	Core	SDVO controller device	Driven	Driven	Off	Off
SDVO_TVCLKINP, SDVO_TVCLKINN	Core	SDVO controller device	Driven	Driven	Off	Off
SDVO_STALLP, SDVO_STALLN	Core	SDVO controller device	Driven	Driven	Off	Off

NOTES:

1. These signals can be configured as outputs in GPIO mode.
2. This signal is sampled as a functional strap during Reset. Refer to Functional straps definition table for usage.
3. External Termination is required for JTAG enabling.
4. Not all signals or pin functionalities may be available on a given SKU. See [Section 1.3](#) and [Chapter 2](#) for details.





4 PCH and System Clocks

PCH provides a complete system clocking solution through Integrated Clocking.

PCH based platforms require several single-ended and differential clocks to synchronize signal operation and data propagation system-wide between interfaces, and across clock domains. In Integrated Clock mode, all the system clocks will be provided by PCH from a 25 MHz crystal generated clock input.

The output signals from PCH are:

- One 100 MHz differential source for BCLK and DMI (PCI Express 2.0 jitter tolerant)
- One 120 MHz differential source for embedded DisplayPort (Mobile Only) on Integrated Graphics processors.
- Ten 100 MHz differential sources for PCI Express 2.0
- One 100 MHz differential clock for XDP/ITP
- Five 33 MHz single-ended source for PCI/other devices (One of these is reserved as loopback clock)
- Four flexible single-ended outputs that can be used for 14.31818/24/27/33/48 MHz for legacy platform functions, discrete graphics devices, external USB controllers, etc.

4.1 Platform Clocking Requirements

Providing a platform-level clocking solution uses multiple system components including:

- The PCH
- 25 MHz Crystal source

Table 4-1 shows the system clock input to PCH. Table 4-2 shows system clock outputs generated by PCH.

Table 4-1. PCH Clock Inputs

Clock Domain	Frequency	Usage description
CLKIN_DMI_P, CLKIN_DMI_N	100 MHz	Unused. External Termination required.
CLKIN_DOT96_P, CLKIN_DOT96_N	96 MHz	Unused. External Termination required.
CLKIN_SATA_P/ CLKIN_SATA_N	100 MHz	Unused. External Termination required.
CLKIN_PCILoopB ACK	33 MHz	33 MHz clock feedback input to reduce skew between PCH PCI clock and clock observed by connected PCI devices. This signal must be connected to one of the pins in the group CLKOUT_PCI[4:0]
REFCLK14IN	14.31818 MHz	Unused. External Termination required.
XTAL25_IN	25 MHz	Crystal input source used by PCH.

NOTES:

1. CLKIN_GND0_[P:N] (Desktop pins only) is NOT used and requires external termination on Desktop platforms.
2. CLKIN_GND1_[P:N] is NOT used and requires external termination on Mobile and Desktop platforms.

Table 4-2. Clock Outputs

Clock Domain	Frequency	Spread Spectrum	Usage
CLKOUT_PCI[4:0]	33 MHz	Yes	Single Ended 33 MHz outputs to PCI connectors/ devices. One of these signals must be connected to CLKIN_PCILoopback to function as a PCI clock loopback. This allows skew control for variable lengths of CLKOUT_PCI[4:0] . NOTE: Not all SKUs may support PCI devices. See Section 1.3 for details.
CLKOUT_DMI_P, CLKOUT_DMI_N	100 MHz	Yes	100 MHz PCIe* Gen2.0 differential output to the processor for DMI/BCLK.
CLKOUT_PCIE[7:0]_P, CLKOUT_PCIE[7:0]_N	100 MHz	Yes	100 MHz PCIe Gen2.0 specification differential output to PCI Express devices.
CLKOUT_PEG_A_P, CLKOUT_PEG_A_N, CLKOUT_PEG_B_P, CLKOUT_PEG_B_N,	100 MHz	Yes	100 MHz PCIe Gen2 specification differential output to PCI Express Graphics devices.
CLKOUT_ITPXD_P, CLKOUT_ITPXD_N	100 MHz	Yes	Used as 100 MHz Clock to processor XDP/ITP on the platform.
CLKOUT_DP_P, CLKOUT_DP_N	120 MHz	Yes	120 MHz Differential output to processor for embedded DisplayPort
CLKOUTFLEX0/ GPIO64	33 MHz / 14.31818 MHz / 27 MHz (SSC/ non-SSC) / 48 MHz / 24MHz	No	33 MHz, 48/24 MHz or 14.31818 MHz outputs for various platform devices such as PCI/LPC or SIO/EC devices, 27 MHz (SSC/non-SSC) clock for discrete graphics devices.
CLKOUTFLEX1/ GPIO65, CLKOUTFLEX3/ GPIO67	14.31818 MHz / 27 MHz (SSC/ non-SSC) / 48 MHz / 24 MHz	No	48/24 MHz or 14.31818 MHz outputs for various platform devices such as PCI/LPC or SIO/EC devices, 27 MHz (SSC/non-SSC) clock for discrete graphics devices.
CLKOUTFLEX2/ GPIO64	33 MHz / 25 MHz / 14.31818 MHz / 27MHz (SSC/ non-SSC) / 48 MHz / 24 MHz	No	33 MHz, 25MHz, 48/24 MHz or 14.31818 MHz outputs for various platform devices such as PCI/ LPC or SIO/EC devices, 27 MHz (SSC/non-SSC) clock for discrete graphics devices.
SPI_CLK	17.86 MHz/ 31.25 MHz	No	Drive SPI devices connected to the PCH. Generated by the PCH.

Figure 4-1 shows the high level block diagram of PCH clocking.



Figure 4-1. PCH High-Level Clock Diagram

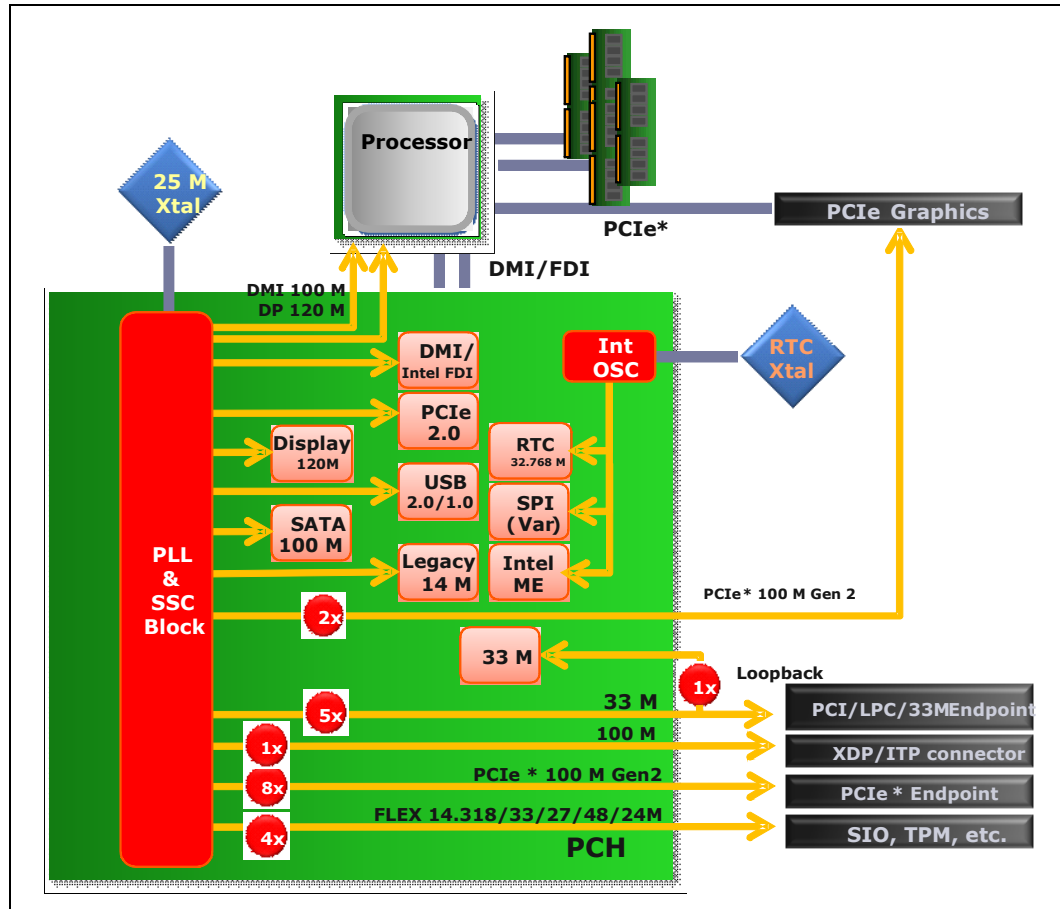

4.2 Functional Blocks

The PCH has up to 8 PLLs, 4 Spread Modulators, and a numbers of dividers to provide great flexibility in clock source selection, configuration, and better power management.

Table 4-3 describes the PLLs on the PCH and the clock domains that are driven from the PLLs.

Table 4-3. PCH PLLs

PLL	Outputs ¹	Description/Usage
XCK_PLL	Eight 2.4 GHz 45° phase shifted. Outputs are routed to each of the Spread Modulator blocks before hitting the various dividers and the other PLLs to provide appropriate clocks to all of the I/O interface logic.	Main Reference PLL. Always enabled in Integrated Clocking mode. Resides in core power well and is not powered in S3 and below states.
DMI_PLL	2.5 GHz/625 MHz/250 MHz DMI Gen2 clocks	Source clock is 100 MHz from XCK_PLL (post-dividers). It is the primary PLL resource to generate the DMI port clocks. Resides in core power well and is not powered in S3 and below states.
FDI_PLL	2.7 GHz/270 MHz/450 MHz FDI logic and link clocks	Source clock is 100 MHz from XCK_PLL (post-dividers). Resides in the core power well and is not powered in S3 and below states.
PCIEXP_PLL	2.5 GHz/625 MHz/500 MHz/250 MHz/125 MHz clocks for PCI Express* 2.0 interface.	Source clock is from XCK_PLL. PCIEXP_PLL drives clocks to PCIe ports and Intel® ME engine ² (in S0 state). Can be optionally used to supply DMI clocks. Resides in the core power well and is not powered in S3 and below states.
SATA_PLL	3.0 GHz/1.5 GHz/300 MHz/150 MHz clocks for SATA logic (serial clock, Tx/Rx clocks)	Source clock is 100 MHz from XCK_PLL (post-divider). This PLL generates all the required SATA Gen2 and SATA Gen3 clocks. Resides in core power well and is not powered in S3 and below states.
USB_PLL	24-/48-/240-/480 MHz clocks for legacy USB 2.0/USB 1.0 logic	Source clock is from XCK_PLL (post-divider). Resides in core power well and is not powered in S3 and below states.
DPLL_A/B	Runs with a wide variety of frequency and divider options.	Source clock is 120 MHz from XCK_PLL (post-divider). Provides Reference clocks required for Integrated Graphics Display. Resides in core power well and is not powered in S3 and below states.

NOTES:

1. Indicates the source clock frequencies driven to other internal logic for delivering functionality needed. Does not indicate external outputs
2. Powered in sub-S0 states by a Suspend well Ring oscillator.

Table 4-4 provides a basic description of the Spread modulators. The spread modulators each operate on the XCK PLL's 2.4 GHz outputs. Spread Spectrum tuning and adjustment can be made on the fly without a platform reboot using specific programming sequence to the clock registers.

**Table 4-4. SSC Blocks**

Modulator	Description
SSC1	Used for 120 MHz fixed frequency Spread Spectrum Clock. Supports up to 0.5% spread
SSC2	Used for 100 MHz Spread Spectrum Clock. Supports up to 0.5% spread.
SSC3	Used for 100 MHz fixed frequency SSC Clock. Supports up to 0.5% spread.
SSC4	Used for 120 MHz fixed-frequency super-spread clocks. Supports 0.5% spread for the 100 MHz and up to 2.5% super-spread for the 120 MHz display clock for Integrated Graphics.

4.3 Clock Configuration Access Overview

The PCH provides increased flexibility of host equivalent configurability of clocks, using Intel ME FW.

In the Intel ME FW assisted configuration mode, Control settings for PLLs, Spread Modulators and other clock configuration registers will be handled by the Intel ME engine. The parameters to be loaded will reside in the Intel ME data region of the SPI Flash device. BIOS would only have access to the register set through a set of Intel MEI commands to the Intel ME.

4.4 Straps Related to Clock Configuration

There are no functional (pin) straps required for clock configuration.

The following soft-straps are implemented on PCH for Clock Configuration: Integrated Clocking Profile Select: 3 Profile select bits allow up to 8 different clock profiles to be specified in the SPI flash device. In addition, 3 RTC well backed host register bits are also defined for Integrated Clocking Profile Selection through BIOS.

§ §

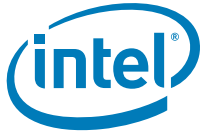



5 Functional Description

This chapter describes the functions and interfaces of the PCH.

5.1 DMI-to-PCI Bridge (D30:F0)

The DMI-to-PCI bridge resides in PCI Device 30, Function 0 on Bus 0. This portion of the PCH implements the buffering and control logic between PCI and Direct Media Interface (DMI). The arbitration for the PCI bus is handled by this PCI device. The PCI decoder in this device must decode the ranges for the DMI. All register contents are lost when core well power is removed.

Direct Media Interface (DMI) is the chip-to-chip connection between the processor and the PCH. This high-speed interface integrates advanced priority-based servicing allowing for concurrent traffic and true isochronous transfer capabilities. Base functionality is completely software transparent permitting current and legacy software to operate normally.

To provide for true isochronous transfers and configurable Quality of Service (QoS) transactions, the PCH supports two virtual channels on DMI—VC0 and VC1. These two channels provide a fixed arbitration scheme where VC1 is always the highest priority. VC0 is the default conduit of traffic for DMI and is always enabled. VC1 must be specifically enabled and configured at both ends of the DMI link (that is, the PCH and processor).

Configuration registers for DMI, virtual channel support, and DMI active state power management (ASPM) are in the RCRB space in the Chipset Config Registers ([Chapter 10](#)).

DMI is also capable of operating in an Enterprise Southbridge Interface (ESI) compatible mode. ESI is a chip-to-chip connection for server/workstation chipsets. In this ESI-compatible mode, the DMI signals require AC coupling. A hardware strap is used to configure DMI in ESI-compatible mode see [Section 2.27](#) for details.

5.1.1 PCI Bus Interface

The PCH PCI interface supports *PCI Local Bus Specification*, Revision 2.3, at 33 MHz. The PCH integrates a PCI arbiter that supports up to four external PCI bus masters in addition to the internal PCH requests.

Note: PCI Bus Interface is not available on any Mobile PCH SKUs. PCI Bus Interface is also not available on certain Desktop PCH SKUs. See [Section 5.1.9](#) for alternative methods for supporting PCI devices.

5.1.2 PCI Bridge As an Initiator

The bridge initiates cycles on the PCI bus when granted by the PCI arbiter. The bridge generates the following cycle types:

Table 5-1. PCI Bridge Initiator Cycle Types

Command	C/BE#	Notes
I/O Read/Write	2h/3h	Non-posted
Memory Read/Write	6h/7h	Writes are posted
Configuration Read/Write	Ah/Bh	Non-posted
Special Cycles	1h	Posted

5.1.2.1 Memory Reads and Writes

The bridge bursts memory writes on PCI that are received as a single packet from DMI.

5.1.2.2 I/O Reads and Writes

The bridge generates single DW I/O read and write cycles. When the cycle completes on the PCI bus, the bridge generates a corresponding completion on DMI. If the cycle is retried, the cycle is kept in the down bound queue and may be passed by a postable cycle.

5.1.2.3 Configuration Reads and Writes

The bridge generates single DW configuration read and write cycles. When the cycle completes on the PCI bus, the bridge generates a corresponding completion on DMI. If the cycle is retried, the cycle is kept in the down bound queue and may be passed by a postable cycle.

5.1.2.4 Locked Cycles

The bridge propagates locks from DMI per the *PCI Local Bus Specification*. The PCI bridge implements bus lock, which means the arbiter will not grant to any agent except DMI while locked.

If a locked read results in a target or master abort, the lock is not established (as per the *PCI Local Bus Specification*). Agents north of the PCH must not forward a subsequent locked read to the bridge if they see the first one finish with a failed completion.

5.1.2.5 Target / Master Aborts

When a cycle initiated by the bridge is master/target aborted, the bridge will not re-attempt the same cycle. For multiple DW cycles, the bridge increments the address and attempts the next DW of the transaction. For all non-postable cycles, a target abort response packet is returned for each DW that was master or target aborted on PCI. The bridge drops posted writes that abort.

5.1.2.6 Secondary Master Latency Timer

The bridge implements a Master Latency Timer using the SMLT register which, upon expiration, causes the deassertion of FRAME# at the next legal clock edge when there is another active request to use the PCI bus.



5.1.2.7 Dual Address Cycle (DAC)

The bridge will issue full 64-bit dual address cycles for device memory-mapped registers above 4 GB.

5.1.2.8 Memory and I/O Decode to PCI

The PCI bridge in the PCH is a **subtractive decode agent** that follows the following rules when forwarding a cycle from DMI to the PCI interface:

- The PCI bridge will **positively** decode any memory/IO address within its window registers, assuming PCICMD.MSE (D30:F0:Offset 04h:bit 1) is set for memory windows and PCICMD.IOSE (D30:F0:Offset 04h:bit 0) is set for I/O windows.
- The PCI bridge will **subtractively** decode any 64-bit memory address not claimed by another agent, assuming PCICMD.MSE (D30:F0:Offset 04h:bit 1) is set.
- The PCI bridge will **subtractively** decode any 16-bit I/O address not claimed by another agent assuming PCICMD.IOSE (D30:F0:Offset 04h:bit 0) is set.
- If BCTRL.IE (D30:F0:Offset 3Eh:bit 2) is set, the PCI bridge will **not positively** forward from primary to secondary called out ranges in the I/O window per *PCI Local Bus Specification* (I/O transactions addressing the last 768 bytes in each, 1 KB block: offsets 100h to 3FFh). The PCI bridge will still take them subtractively assuming the above rules.
- If BCTRL.VGAE (D30:F0:Offset 3Eh:bit 3) is set, the PCI bridge will **positively** forward from primary to secondary I/O and memory ranges as called out in the *PCI Bridge Specification*, assuming the above rules are met.

5.1.3 Parity Error Detection and Generation

PCI parity errors can be detected and reported. The following behavioral rules apply:

- When a parity error is detected on PCI, the bridge sets the SECSTS.DPE (D30:F0:Offset 1Eh:Bit 15).
- If the bridge is a master and BCTRL.PERE (D30:F0:Offset 3Eh:Bit 0) is set and one of the parity errors defined below is detected on PCI, then the bridge will set SECSTS.DPD (D30:F0:Offset 1Eh:Bit 8) and will also generate an internal SERR#.
 - During a write cycle, the PERR# signal is active, or
 - A data parity error is detected while performing a read cycle
- If an address or command parity error is detected on PCI and PCICMD.SEE (D30:F0:Offset 04h:Bit 8), BCTRL.PERE, and BCTRL.SEE (D30:F0:Offset 3Eh:bit 1) are all set, the bridge will set PSTS.SSE (D30:F0:Offset 06h:Bit 14) and generate an internal SERR#.
- If the PSTS.SSE is set because of an address parity error and the PCICMD.SEE is set, the bridge will generate an internal SERR#.
- When bad parity is detected from DMI, bad parity will be driven on all data from the bridge.
- When an address parity error is detected on PCI, the PCI bridge will never claim the cycle. This is a slight deviation from the PCI bridge specification that says that a cycle should be claimed if BCTRL.PERE is not set. However, DMI does not have a concept of address parity error, so claiming the cycle could result in the rest of the system seeing a bad transaction as a good transaction.

5.1.4 PCIRST#

The PCIRST# pin is generated under two conditions:

- PLTRST# active
- BCTRL.SBR (D30:F0:Offset 3Eh:Bit 6) set to 1

The PCIRST# pin is in the suspend well. PCIRST# should be tied to PCI bus agents, but not other agents in the system.

5.1.5 Peer Cycles

The PCI bridge may be the initiator of peer cycles. Peer cycles include memory, I/O, and configuration cycle types. Peer cycles are only allowed through VC0, and are enabled with the following bits:

- BPC.PDE (D30:F0:Offset 4Ch:Bit 2) – Memory and I/O cycles
- BPC.CDE (D30:F0:Offset 4Ch:Bit 1) – Configuration cycles

When enabled for peer for one of the above cycle types, the PCI bridge will perform a peer decode to see if a peer agent can receive the cycle. When not enabled, memory cycles (posted and/or non-posted) are sent to DMI, and I/O and/or configuration cycles are not claimed.

Configuration cycles have special considerations. Under the *PCI Local Bus Specification*, these cycles are not allowed to be forwarded upstream through a bridge. However, to enable things such as manageability, BPC.CDE can be set. When set, type 1 cycles are allowed into the part. The address format of the type 1 cycle is slightly different from a standard PCI configuration cycle to allow addressing of extended PCI space. The format is shown in [Table 5-2](#).

Table 5-2. Type 1 Address Format

Bits	Definition
31:27	Reserved (same as the <i>PCI Local Bus Specification</i>)
26:24	Extended Configuration Address – allows addressing of up to 4 KB. These bits are combined with Bits 7:2 to get the full register.
23:16	Bus Number (same as the <i>PCI Local Bus Specification</i>)
15:11	Device Number (same as the <i>PCI Local Bus Specification</i>)
10:8	Function Number (same as the <i>PCI Local Bus Specification</i>)
7:2	Register (same as the <i>PCI Local Bus Specification</i>)
1	0
0	Must be 1 to indicate a type 1 cycle. Type 0 cycles are not decoded.

Note: The PCH USB controllers cannot perform peer-to-peer traffic.

5.1.6 PCI-to-PCI Bridge Model

From a software perspective, the PCH contains a PCI-to-PCI bridge. This bridge connects DMI to the PCI bus. By using the PCI-to-PCI bridge software model, the PCH can have its decode ranges programmed by existing plug-and-play software such that PCI ranges do not conflict with graphics aperture ranges in the Host controller.



5.1.7 IDSEL to Device Number Mapping

When addressing devices on the external PCI bus (with the PCI slots), the PCH asserts one address signal as an IDSEL. When accessing Device 0, the PCH asserts AD16. When accessing Device 1, the PCH asserts AD17. This mapping continues all the way up to Device 15 where the PCH asserts AD31. Note that the PCH internal functions (Intel[®] High Definition Audio, USB, SATA and PCI Bridge) are enumerated like they are off of a separate PCI bus (DMI) from the external PCI bus.

5.1.8 Standard PCI Bus Configuration Mechanism

The PCI Bus defines a slot based "configuration space" that allows each device to contain up to eight functions with each function containing up to 256, 8-bit configuration registers. The *PCI Local Bus Specification*, Revision 2.3 defines two bus cycles to access the PCI configuration space: Configuration Read and Configuration Write. Memory and I/O spaces are supported directly by the processor. Configuration space is supported by a mapping mechanism implemented within the PCH. The *PCI Local Bus Specification*, Revision 2.3 defines two mechanisms to access configuration space, Mechanism 1 and Mechanism 2. The PCH only supports Mechanism 1.

Warning: Configuration writes to internal devices, when the devices are disabled, are illegal and may cause undefined results.

5.1.9 PCI Legacy Mode

For some PCH SKUs, native PCI functionality is not supported requiring methods such as using PCIe*-to-PCI bridges to enable external PCI I/O devices. To be able to use PCIe-to-PCI bridges and attached legacy PCI devices, the PCH provides PCI Legacy Mode. PCI Legacy Mode allows both the PCI Express* root port and PCIe-to-PCI bridge look like subtractive PCI-to-PCI bridges. This allows the PCI Express root port to subtractively decode and forward legacy cycles to the bridge, and the PCIe-to-PCI bridge continues forwarding legacy cycles to downstream PCI devices. For designs that would like to utilize PCI Legacy Mode, BIOS must program registers in the DMI-to-PCI bridge (Device 30:Function 0) and in the desired PCI Express Root Port (Device 28:Functions 0-7) to enable subtractive decode.

Note: Software must ensure that only one PCH device is enabled for Subtractive decode at a time.



5.2 PCI Express* Root Ports (D28:F0,F1,F2,F3,F4,F5, F6, F7)

There are eight root ports available in the PCH. The root ports are compliant to the PCI Express 2.0 specification running at 5.0 GT/s. The ports all reside in Device 28, and take Function 0 – 7. Port 1 is Function 0, Port 2 is Function 1, Port 3 is Function 2, Port 4 is Function 3, Port 5 is Function 4, Port 6 is Function 5, Port 7 is Function 6, and Port 8 is Function 7.

Note: This section assumes the default PCI Express Function Number-to-Root Port mapping is used. Function numbers for a given root port are assignable through the Root Port Function Number and Hide for PCI Express Root Ports register (RCBA+0404h).

PCI Express Root Ports 1–4 or Ports 5–8 can independently be configured as four x1s, two x2s, one x2 and two x1s, or one x4 port widths. The port configuration is set by soft straps in the Flash Descriptor.

5.2.1 Interrupt Generation

The root port generates interrupts on behalf of Hot-Plug and power management events, when enabled. These interrupts can either be pin based, or can be MSIs, when enabled.

When an interrupt is generated using the legacy pin, the pin is internally routed to the PCH interrupt controllers. The pin that is driven is based upon the setting of the chipset configuration registers. Specifically, the chipset configuration registers used are the D28IP (Base address + 310Ch) and D28IR (Base address + 3146h) registers.

Table 5-3 summarizes interrupt behavior for MSI and wire-modes. In the table “bits” refers to the Hot-Plug and PME interrupt bits.

Table 5-3. MSI versus PCI IRQ Actions

Interrupt Register	Wire-Mode Action	MSI Action
All bits 0	Wire inactive	No action
One or more bits set to 1	Wire active	Send message
One or more bits set to 1, new bit gets set to 1	Wire active	Send message
One or more bits set to 1, software clears some (but not all) bits	Wire active	Send message
One or more bits set to 1, software clears all bits	Wire inactive	No action
Software clears one or more bits, and one or more bits are set on the same clock	Wire active	Send message



5.2.2 Power Management

5.2.2.1 S3/S4/S5 Support

Software initiates the transition to S3/S4/S5 by performing an I/O write to the Power Management Control register in the PCH. After the I/O write completion has been returned to the processor, each root port will send a PME_Turn_Off TLP (Transaction Layer Packet) message on its downstream link. The device attached to the link will eventually respond with a PME_TO_Ack TLP message followed by sending a PM_Enter_L23 DLLP (Data Link Layer Packet) request to enter the L2/L3 Ready state. When all of the PCH root ports links are in the L2/L3 Ready state, the PCH power management control logic will proceed with the entry into S3/S4/S5.

Prior to entering S3, software is required to put each device into D3_{HOT}. When a device is put into D3_{HOT}, it will initiate entry into a L1 link state by sending a PM_Enter_L1 DLLP. Thus, under normal operating conditions when the root ports sends the PME_Turn_Off message, the link will be in state L1. However, when the root port is instructed to send the PME_Turn_Off message, it will send it whether or not the link was in L1. Endpoints attached to PCH can make no assumptions about the state of the link prior to receiving a PME_Turn_Off message.

5.2.2.2 Resuming from Suspended State

The root port contains enough circuitry in the suspend well to detect a wake event through the WAKE# signal and to wake the system. When WAKE# is detected asserted, an internal signal is sent to the power management controller of the PCH to cause the system to wake up. This internal message is not logged in any register, nor is an interrupt/GPE generated due to it.

5.2.2.3 Device Initiated PM_PME Message

When the system has returned to a working state from a previous low power state, a device requesting service will send a PM_PME message continuously, until acknowledged by the root port. The root port will take different actions depending upon whether this is the first PM_PME that has been received, or whether a previous message has been received but not yet serviced by the operating system.

If this is the first message received (RSTS.PS - D28:F0/F1/F2/F3/F4/F5/F6/F7:Offset 60h:bit 16 is cleared), the root port will set RSTS.PS, and log the PME Requester ID into RSTS.RID (D28:F0/F1/F2/F3/F4/F5/F6/F7:Offset 60h:bits 15:0). If an interrupt is enabled using RCTL.PIE (D28:F0/F1/F2/F3/F4/F5/F6/F7:Offset 5Ch:bit 3), an interrupt will be generated. This interrupt can be either a pin or an MSI if MSI is enabled using MC.MSIE (D28:F0/F1/F2/F3/F4/F5/F6/F7:Offset 82h:Bit 0). See [Section 5.2.2.4](#) for SMI/SCI generation.

If this is a subsequent message received (RSTS.PS is already set), the root port will set RSTS.PP (D28:F0/F1/F2/F3/F4/F5/F6/F7:Offset 60h:Bit 17) and log the PME Requester ID from the message in a hidden register. No other action will be taken.

When the first PME event is cleared by software clearing RSTS.PS, the root port will set RSTS.PS, clear RSTS.PP, and move the requester ID from the hidden register into RSTS.RID.

If RCTL.PIE is set, an interrupt will be generated. If RCTL.PIE is not set, a message will be sent to the power management controller so that a GPE can be set. If messages have been logged (RSTS.PS is set), and RCTL.PIE is later written from a 0 to a 1, an interrupt will be generated. This last condition handles the case where the message was received prior to the operating system re-enabling interrupts after resuming from a low power state.

5.2.2.4 SMI/SCI Generation

Interrupts for power management events are not supported on legacy operating systems. To support power management on non-PCI Express aware operating systems, PM events can be routed to generate SCI. To generate SCI, MPC.PMCE must be set. When set, a power management event will cause SMSCS.PMCS (D28:F0/F1/F2/F3/F4/F5/F6/F7:Offset DCh:Bit 31) to be set.

Additionally, BIOS workarounds for power management can be supported by setting MPC.PMME (D28:F0/F1/F2/F3/F4/F5/F6/F7:Offset D8h:Bit 0). When this bit is set, power management events will set SMSCS.PMMS (D28:F0/F1/F2/F3/F4/F5/F6/F7:Offset DCh:Bit 0), and SMI # will be generated. This bit will be set regardless of whether interrupts or SCI is enabled. The SMI# may occur concurrently with an interrupt or SCI.

5.2.3 SERR# Generation

SERR# may be generated using two paths – through PCI mechanisms involving bits in the PCI header, or through PCI Express* mechanisms involving bits in the PCI Express capability structure.

Figure 5-1. Generation of SERR# to Platform

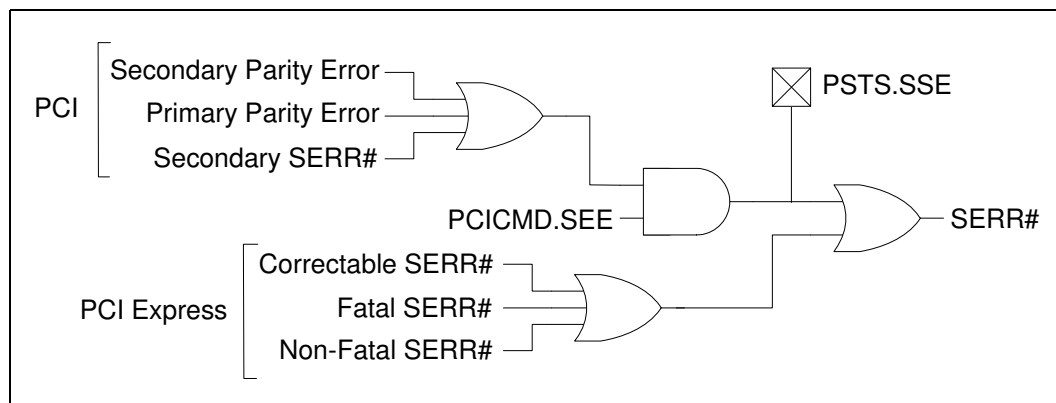

5.2.4 Hot-Plug

Each root port implements a Hot-Plug controller that performs the following:

- Messages to turn on/off/blink LEDs
- Presence and attention button detection
- Interrupt generation

The root port only allows Hot-Plug with modules (such as, ExpressCard*). Edge-connector based Hot-Plug is not supported.

5.2.4.1 Presence Detection

When a module is plugged in and power is supplied, the physical layer will detect the presence of the device, and the root port sets SLSTS.PDS (D28:F0/F1/F2/F3/F4/F5:Offset 5Ah:Bit 6) and SLSTS.PDC (D28:F0/F1/F2/F3:Offset 6h:Bit 3). If SLCTL.PDE (D28:F0/F1/F2/F3/F4/F5/F6/F7:Offset 58h:Bit 3) and SLCTL.HPE (D28:F0/F1/F2/F3/F4/F5/F6/F7:Offset 58h:Bit 5) are both set, the root port will also generate an interrupt.



When a module is removed (using the physical layer detection), the root port clears SLSTS.PDS and sets SLSTS.PDC. If SLCTL.PDE and SLCTL.HPE are both set, the root port will also generate an interrupt.

5.2.4.2 Message Generation

When system software writes to SLCTL.AIC (D28:F0/F1/F2/F3/F4/F5/F6/F7:Offset 58h:Bits 7:6) or SLCTL.PIC (D28:F0/F1/F2/F3/F4/F5/F6/F7:Offset 58h:Bits 9:8), the root port will send a message down the link to change the state of LEDs on the module.

Writes to these fields are non-postable cycles, and the resulting message is a postable cycle. When receiving one of these writes, the root port performs the following:

- Changes the state in the register.
- Generates a completion into the upstream queue
- Formulates a message for the downstream port if the field is written to regardless of if the field changed.
- Generates the message on the downstream port
- When the last message of a command is transmitted, sets SLSTS.CCE (D28:F0/F1/F2/F3/F4/F5/F6/F7:Offset 58h:Bit 4) to indicate the command has completed. If SLCTL.CCE and SLCTL.HPE (D28:F0/F1/F2/F3/F4/F5/F6/F7:Offset 58h:Bit 5) are set, the root port generates an interrupt.

The command completed register (SLSTS.CC) applies only to commands issued by software to control the Attention Indicator (SLCTL.AIC), Power Indicator (SLCTL.PIC), or Power Controller (SLCTL.PCC). However, writes to other parts of the Slot Control Register would invariably end up writing to the indicators and power controller fields. Hence, any write to the Slot Control Register is considered a command and if enabled, will result in a command complete interrupt. The only exception to this rule is a write to disable the command complete interrupt which will not result in a command complete interrupt.

A single write to the Slot Control register is considered to be a single command, and hence receives a single command complete, even if the write affects more than one field in the Slot Control Register.

5.2.4.3 Attention Button Detection

When an attached device is ejected, an attention button could be pressed by the user. This attention button press will result in a the PCI Express message "Attention_Button_Pressed" from the device. Upon receiving this message, the root port will set SLSTS.ABP (D28:F0/F1/F2/F3/F4/F5/F6/F7:Offset 5Ah:Bit 0).

If SLCTL.ABE (D28:F0/F1/F2/F3/F4/F5:Offset 58h:bit 0) and SLCTL.HPE (D28:F0/F1/F2/F3/F4/F5/F6/F7:Offset 58h:Bit 5) are set, the Hot-Plug controller will also generate an interrupt. The interrupt is generated on an edge-event. For example, if SLSTS.ABP is already set, a new interrupt will not be generated.

5.2.4.4 SMI/SCI Generation

Interrupts for Hot-Plug events are not supported on legacy operating systems. To support Hot-Plug on n on-PCI Express aware operating systems, Hot-Plug events can be routed to generate SCI. To generate SCI, MPC.HPCE (D28:F0/F1/F2/F3/F4/F5/F6/F7:Offset D8h:Bit 30) must be set. When set, enabled Hot-Plug events will cause SMSCS.HPCS (D28:F0/F1/F2/F3/F4/F5/F6/F7:Offset DCh:Bit 30) to be set.

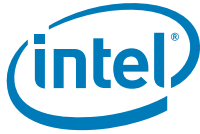

Additionally, BIOS workarounds for Hot-Plug can be supported by setting MPC.HPME (D28:F0/F1/F2/F3/F4/F5/F6/F7:Offset D8h:Bit 1). When this bit is set, Hot-Plug events can cause SMI status bits in SMSCS to be set. Supported Hot-Plug events and their corresponding SMSCS bit are:

- Command Completed – SCSCS.HPCCM (D28:F0/F1/F2/F3/F4/F5/F6/F7:Offset DCh:Bit 3)
- Presence Detect Changed – SMSCS.HPPDM (D28:F0/F1/F2/F3/F4/F5/F6/F7:Offset DCh:Bit 1)
- Attention Button Pressed – SMSCS.HPABM (D28:F0/F1/F2/F3/F4/F5/F6/F7:Offset DCh:Bit 2)
- Link Active State Changed – SMSCS.HPLAS (D28:F0/F1/F2/F3/F4/F5/F6/F7:Offset DCh:Bit 4)

When any of these bits are set, SMI# will be generated. These bits are set regardless of whether interrupts or SCI is enabled for Hot-Plug events. The SMI# may occur concurrently with an interrupt or SCI.

5.3 Gigabit Ethernet Controller (B0:D25:F0)

The PCH integrates a Gigabit Ethernet (GbE) controller. The integrated GbE controller is compatible with the Intel® 82579 Platform LAN Connect device. The integrated GbE controller provides two interfaces for 10/100/1000 Mb/s and manageability operation:

- Based on PCI Express – A high-speed SerDes interface using PCI Express electrical signaling at half speed while keeping the custom logical protocol for active state operation mode.
- System Management Bus (SMBus) – A very low speed connection for low power state mode for manageability communication only. At this low power state mode the Ethernet link speed is reduced to 10 Mb/s.

The 82579 can be connected to any available PCI Express port in the PCH. The 82579 only runs at a speed of 1250 Mb/s, which is 1/2 of the 2.5 Gb/s PCI Express frequency. Each of the PCI Express root ports in the PCH have the ability to run at the 1250 Mb/s rate. There is no need to implement a mechanism to detect that the 82579 LAN device is connected. The port configuration (if any), attached to the 82579 LAN device, is pre-loaded from the NVM. The selected port adjusts the transmitter to run at the 1250 Mb/s rate and does not need to be PCI Express compliant.

Note: PCIe validation tools cannot be used for electrical validation of this interface; however, PCIe layout rules apply for on-board routing.

The integrated GbE controller operates at full-duplex at all supported speeds or half-duplex at 10/100 Mb/s. It also adheres to the *IEEE 802.3x Flow Control Specification*.

Note: GbE operation (1000 Mb/s) is only supported in S0 mode. In Sx modes, SMBus is the only active bus and is used to support manageability/remote wake-up functionality.

The integrated GbE controller provides a system interface using a PCI Express function. A full memory-mapped or I/O-mapped interface is provided to the software, along with DMA mechanisms for high performance data transfer.



The integrated GbE controller features are:

- Network Features
 - Compliant with the 1 Gb/s Ethernet 802.3 802.3u 802.3ab specifications
 - Multi-speed operation: 10/100/1000 Mb/s
 - Full-duplex operation at 10/100/1000 Mb/s: Half-duplex at 10/100 Mb/s
 - Flow control support compliant with the 802.3X specification
 - VLAN support compliant with the 802.3q specification
 - MAC address filters: perfect match unicast filters; multicast hash filtering, broadcast filter and promiscuous mode
 - PCI Express/SMBus interface to GbE PHYs
- Host Interface Features
 - 64-bit address master support for systems using more than 4 GB of physical memory
 - Programmable host memory receive buffers (256 Bytes to 16 KB)
 - Intelligent interrupt generation features to enhance driver performance
 - Descriptor ring management hardware for transmit and receive
 - Software controlled reset (resets everything except the configuration space)
 - Message Signaled Interrupts
- Performance Features
 - Configurable receive and transmit data FIFO, programmable in 1 KB increments
 - TCP segmentation capability compatible with Windows NT* 5.x off loading features
 - Fragmented UDP checksum offload for packet reassembly
 - IPv4 and IPv6 checksum offload support (receive, transmit, and TCP segmentation offload)
 - Split header support to eliminate payload copy from user space to host space
 - Receive Side Scaling (RSS) with two hardware receive queues
 - Supports 9018 bytes of jumbo packets
 - Packet buffer size
 - LinkSec offload compliant with 802.3ae specification
 - TimeSync offload compliant with 802.1as specification
- Virtualization Technology Features
 - Warm function reset – function level reset (FLR)
 - VMDq1
- Power Management Features
 - Magic Packet* wake-up enable with unique MAC address
 - ACPI register set and power down functionality supporting D0 and D3 states
 - Full wake up support (APM, ACPI)
 - MAC power down at Sx, DMoff with and without WoL



5.3.1 GbE PCI Express* Bus Interface

The GbE controller has a PCI Express interface to the host processor and host memory. The following sections detail the bus transactions.

5.3.1.1 Transaction Layer

The upper layer of the host architecture is the transaction layer. The transaction layer connects to the device core using an implementation specific protocol. Through this core-to-transaction-layer protocol, the application-specific parts of the device interact with the subsystem and transmit and receive requests to or from the remote agent, respectively.

5.3.1.2 Data Alignment

5.3.1.2.1 4-KB Boundary

PCI requests must never specify an address/length combination that causes a memory space access to cross a 4 KB boundary. It is hardware's responsibility to break requests into 4 KB-aligned requests (if needed). This does not pose any requirement on software. However, if software allocates a buffer across a 4-KB boundary, hardware issues multiple requests for the buffer. Software should consider aligning buffers to a 4-KB boundary in cases where it improves performance.

The alignment to the 4-KB boundaries is done in the core. The transaction layer does not do any alignment according to these boundaries.

5.3.1.2.2 64 Bytes

PCI requests are multiples of 64 bytes and aligned to make better use of memory controller resources. Writes, however, can be on any boundary and can cross a 64-byte alignment boundary.

5.3.1.3 Configuration Request Retry Status

The integrated GbE controller might have a delay in initialization due to an NVM read. If the NVM configuration read operation is not completed and the device receives a configuration request, the device responds with a configuration request retry completion status to terminate the request, and thus effectively stalls the configuration request until such time that the sub-system has completed local initialization and is ready to communicate with the host.



5.3.2 Error Events and Error Reporting

5.3.2.1 Data Parity Error

The PCI host bus does not provide parity protection, but it does forward parity errors from bridges. The integrated GbE controller recognizes parity errors through the internal bus interface and sets the *Parity Error* bit in PCI configuration space. If parity errors are enabled in configuration space, a system error is indicated on the PCI host bus. The offending cycle with a parity error is dropped and not processed by the integrated GbE controller.

5.3.2.2 Completion with Unsuccessful Completion Status

A completion with unsuccessful completion status (any status other than 000) is dropped and not processed by the integrated GbE controller. Furthermore, the request that corresponds to the unsuccessful completion is not retried. When this unsuccessful completion status is received, the *System Error* bit in the PCI configuration space is set. If the system errors are enabled in configuration space, a system error is indicated on the PCI host bus.

5.3.3 Ethernet Interface

The integrated GbE controller provides a complete CSMA/CD function supporting IEEE 802.3 (10 Mb/s), 802.3u (100 Mb/s) implementations. It also supports the IEEE 802.3z and 802.3ab (1000 Mb/s) implementations. The device performs all of the functions required for transmission, reception, and collision handling called out in the standards.

The mode used to communicate between the PCH and the 82579 PHY supports 10/100/1000 Mb/s operation, with both half- and full-duplex operation at 10/100 Mb/s, and full-duplex operation at 1000 Mb/s.

5.3.3.1 82579 LAN PHY Interface

The integrated GbE controller and the 82579 PHY communicate through the PCIe and SMBus interfaces. All integrated GbE controller configuration is performed using device control registers mapped into system memory or I/O space. The 82579 device is configured using the PCI Express or SMBus interface.

The integrated GbE controller supports various modes as listed in [Table 5-4](#).

Table 5-4. LAN Mode Support

Mode	System State	Interface Active	Connections
Normal 10/100/1000 Mb/s	S0	PCI Express or SMBus ¹	82579
Manageability and Remote Wake-up	Sx	SMBus	82579

NOTES:

1. GbE operation is not supported in Sx states.



5.3.4 PCI Power Management

The integrated GbE controller supports the Advanced Configuration and Power Interface (ACPI) specification as well as Advanced Power Management (APM). This enables the network-related activity (using an internal host wake signal) to wake up the host. For example, from Sx (S3–S5) to S0.

The integrated GbE controller contains power management registers for PCI and supports D0 and D3 states. PCIe transactions are only allowed in the D0 state, except for host accesses to the integrated GbE controller's PCI configuration registers.

5.3.4.1 Wake Up

The integrated GbE controller supports two types of wake-up mechanisms:

1. Advanced Power Management (APM) Wake Up
2. ACPI Power Management Wake Up

Both mechanisms use an internal logic signal to wake the system up. The wake-up steps are as follows:

1. Host wake event occurs (note that packet is not delivered to host).
2. The 82579 receives a WoL packet/link status change.
3. The 82579 wakes up the integrated GbE controller using an SMBus message.
4. The integrated GbE controller sets the *PME_STATUS* bit.
5. System wakes from Sx state to S0 state.
6. The host LAN function is transitioned to D0.
7. The host clears the *PME_STATUS* bit.

5.3.4.1.1 Advanced Power Management Wake Up

Advanced Power Management Wake Up or APM Wake Up was previously known as Wake on LAN (WoL). It is a feature that has existed in the 10/100 Mb/s NICs for several generations. The basic premise is to receive a broadcast or unicast packet with an explicit data pattern and then to assert a signal to wake up the system. In earlier generations, this was accomplished by using a special signal that ran across a cable to a defined connector on the motherboard. The NIC would assert the signal for approximately 50 ms to signal a wake up. The integrated GbE controller uses (if configured to) an in-band PM_PME message for this.

At power up, the integrated GbE controller reads the *APM Enable* bits from the NVM PCI Init Control Word into the APM Enable (APME) bits of the Wake Up Control (WUC) register. These bits control enabling of APM wake up.

When APM wake up is enabled, the integrated GbE controller checks all incoming packets for Magic Packets.

Once the integrated GbE controller receives a matching Magic Packet, it:

- Sets the Magic Packet *Received* bit in the Wake Up Status (WUS) register.
- Sets the *PME_Status* bit in the Power Management Control/Status Register (PMCSR).

APM wake up is supported in all power states and only disabled if a subsequent NVM read results in the *APM Wake Up* bit being cleared or the software explicitly writes a 0b to the *APM Wake Up* (APM) bit of the WUC register.



Note: APM wake up settings will be restored to NVM default by the PCH when LAN connected Device (PHY) power is turned off and subsequently restored. Some example host WOL flows are:

- When system transitions to G3 after WOL is disabled from the BIOS, APM host WOL would get enabled.
- Anytime power to the LAN Connected Device (PHY) is cycled while in S4/S5 after WOL is disabled from the BIOS, APM host WOL would get enabled. Anytime power to the LAN Connected Device (PHY) is cycled while in S3, APM host WOL configuration is lost.

5.3.4.1.2 ACPI Power Management Wake Up

The integrated GbE controller supports ACPI Power Management based Wake ups. It can generate system wake-up events from three sources:

- Receiving a Magic Packet.
- Receiving a Network Wake Up Packet.
- Detecting a link change of state.

Activating ACPI Power Management Wakeup requires the following steps:

- The software device driver programs the Wake Up Filter Control (WUFC) register to indicate the packets it needs to wake up from and supplies the necessary data to the IPv4 Address Table (IP4AT) and the Flexible Filter Mask Table (FFMT), Flexible Filter Length Table (FFLT), and the Flexible Filter Value Table (FFVT). It can also set the *Link Status Change Wake Up Enable* (LNKC) bit in the Wake Up Filter Control (WUFC) register to cause wake up when the link changes state.
- The operating system (at configuration time) writes a 1b to the *PME_EN* bit of the Power Management Control/Status Register (PMCSR.8).

Normally, after enabling wake up, the operating system writes a 11b to the lower two bits of the PMCSR to put the integrated GbE controller into low-power mode.

Once wake up is enabled, the integrated GbE controller monitors incoming packets, first filtering them according to its standard address filtering method, then filtering them with all of the enabled wake-up filters. If a packet passes both the standard address filtering and at least one of the enabled wake-up filters, the integrated GbE controller:

- Sets the *PME_Status* bit in the PMCSR
- Sets one or more of the *Received* bits in the Wake Up Status (WUS) register. (More than one bit is set if a packet matches more than one filter.)

If enabled, a link state change wake up causes similar results, setting the *Link Status Changed* (LNKC) bit in the Wake Up Status (WUS) register when the link goes up or down.

After receiving a wake-up packet, the integrated GbE controller ignores any subsequent wake-up packets until the software device driver clears all of the *Received* bits in the Wake Up Status (WUS) register. It also ignores link change events until the software device driver clears the *Link Status Changed* (LNKC) bit in the Wake Up Status (WUS) register.

Note: ACPI wake up settings are not preserved when the LAN Connected Device (PHY) power is turned off and subsequently restored. Some example host WOL flows are:

- Anytime power to the LAN Connected Device (PHY) is cycled while in S3 or S4, ACPI host WOL configuration is lost.

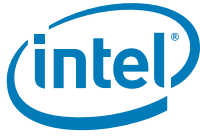

5.3.5 Configurable LEDs

The integrated GbE controller supports three controllable and configurable LEDs that are driven from the 82579 LAN device. Each of the three LED outputs can be individually configured to select the particular event, state, or activity that is indicated on that output. In addition, each LED can be individually configured for output polarity as well as for blinking versus non-blinking (steady-state) indication.

The configuration for LED outputs is specified using the LEDCTL register. Furthermore, the hardware-default configuration for all the LED outputs, can be specified using NVM fields; thereby, supporting LED displays configurable to a particular OEM preference.

Each of the three LEDs might be configured to use one of a variety of sources for output indication. The MODE bits control the LED source:

- LINK_100/1000 is asserted when link is established at either 100 or 1000 Mb/s.
- LINK_10/1000 is asserted when link is established at either 10 or 1000 Mb/s.
- LINK_UP is asserted when any speed link is established and maintained.
- ACTIVITY is asserted when link is established and packets are being transmitted or received.
- LINK/ACTIVITY is asserted when link is established AND there is NO transmit or receive activity
- LINK_10 is asserted when a 10 Mb/ps link is established and maintained.
- LINK_100 is asserted when a 100 Mb/s link is established and maintained.
- LINK_1000 is asserted when a 1000 Mb/s link is established and maintained.
- FULL_DUPLEX is asserted when the link is configured for full duplex operation.
- COLLISION is asserted when a collision is observed.
- PAUSED is asserted when the device's transmitter is flow controlled.
- LED_ON is always asserted; LED_OFF is always deasserted.

The *IVRT* bits enable the LED source to be inverted before being output or observed by the blink-control logic. LED outputs are assumed to normally be connected to the negative side (cathode) of an external LED.

The *BLINK* bits control whether the LED should be blinked while the LED source is asserted, and the blinking frequency (either 200 ms on and 200 ms off or 83 ms on and 83 ms off). The blink control can be especially useful for ensuring that certain events, such as ACTIVITY indication, cause LED transitions, which are sufficiently visible to a human eye. The same blinking rate is shared by all LEDs.

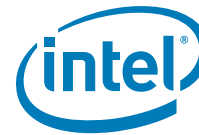

5.3.6 Function Level Reset Support (FLR)

The integrated GbE controller supports FLR capability. FLR capability can be used in conjunction with Intel® Virtualization Technology. FLR allows an operating system in a Virtual Machine to have complete control over a device, including its initialization, without interfering with the rest of the platform. The device provides a software interface that enables the operating system to reset the entire device as if a PCI reset was asserted.

5.3.6.1 FLR Steps

5.3.6.1.1 FLR Initialization

1. FLR is initiated by software by writing a 1b to the *Initiate FLR* bit.
2. All subsequent requests targeting the function are not claimed and will be master aborted immediately on the bus. This includes any configuration, I/O or memory cycles. However, the function will continue to accept completions targeting the function.

5.3.6.1.2 FLR Operation

Function resets all configuration, I/O, and memory registers of the function except those indicated otherwise and resets all internal states of the function to the default or initial condition.

5.3.6.1.3 FLR Completion

The *Initiate FLR* bit is reset (cleared) when the FLR reset completes. This bit can be used to indicate to the software that the FLR reset completed.

Note: From the time the *Initiate FLR* bit is written to 1b, software must wait at least 100 ms before accessing the function.

5.4 LPC Bridge (with System and Management Functions) (D31:F0)

The LPC bridge function of the PCH resides in PCI Device 31:Function 0. In addition to the LPC bridge function, D31:F0 contains other functional units including DMA, Interrupt controllers, Timers, Power Management, System Management, GPIO, and RTC. In this chapter, registers and functions associated with other functional units (power management, GPIO, USB, etc.) are described in their respective sections.

Note: The LPC bridge cannot be configured as a subtractive decode agent.

5.4.1 LPC Interface

The PCH implements an LPC interface as described in the *Low Pin Count Interface Specification*, Revision 1.1. The LPC interface to the PCH is shown in [Figure 5-2](#). Note that the PCH implements all of the signals that are shown as optional, but peripherals are not required to do so.

Figure 5-2. LPC Interface Diagram

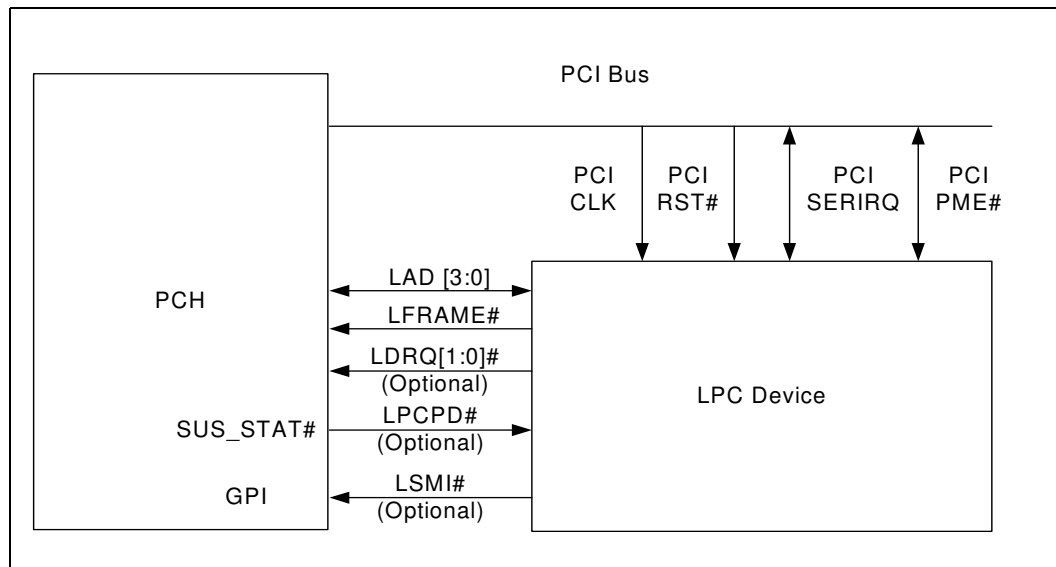



5.4.1.1 LPC Cycle Types

The PCH implements all of the cycle types described in the *Low Pin Count Interface Specification*, Revision 1.1. [Table 5-5](#) shows the cycle types supported by the PCH.

Table 5-5. LPC Cycle Types Supported

Cycle Type	Comment
Memory Read	1 byte only. (See Note 1 below)
Memory Write	1 byte only. (See Note 1 below)
I/O Read	1 byte only. The PCH breaks up 16- and 32-bit processor cycles into multiple 8-bit transfers.
I/O Write	1 byte only. The PCH breaks up 16- and 32-bit processor cycles into multiple 8-bit transfers.
DMA Read	Can be 1, or 2 bytes
DMA Write	Can be 1, or 2 bytes
Bus Master Read	Can be 1, 2, or 4 bytes. (See Note 2 below)
Bus Master Write	Can be 1, 2, or 4 bytes. (See Note 2 below)

NOTES:

- The PCH provides a single generic memory range (LGMR) for decoding memory cycles and forwarding them as LPC Memory cycles on the LPC bus. The LGMR memory decode range is 64 KB in size and can be defined as being anywhere in the 4 GB memory space. This range needs to be configured by BIOS during POST to provide the necessary memory resources. BIOS should advertise the LPC Generic Memory Range as Reserved to the OS in order to avoid resource conflict. For larger transfers, the PCH performs multiple 8-bit transfers. If the cycle is not claimed by any peripheral, it is subsequently aborted, and the PCH returns a value of all 1s to the processor. This is done to maintain compatibility with ISA memory cycles where pull-up resistors would keep the bus high if no device responds.
- Bus Master Read or Write cycles must be naturally aligned. For example, a 1-byte transfer can be to any address. However, the 2-byte transfer must be word-aligned (that is, with an address where A0=0). A DWord transfer must be DWord-aligned (that is, with an address where A1 and A0 are both 0).

5.4.1.2 Start Field Definition

Table 5-6. Start Field Bit Definitions

Bits[3:0] Encoding	Definition
0000	Start of cycle for a generic target
0010	Grant for bus master 0
0011	Grant for bus master 1
1111	Stop/Abort: End of a cycle for a target.

NOTE: All other encodings are RESERVED.

5.4.1.3 Cycle Type / Direction (CYCTYPE + DIR)

The PCH always drives Bit 0 of this field to 0. Peripherals running bus master cycles must also drive Bit 0 to 0. [Table 5-7](#) shows the valid bit encodings.

Table 5-7. Cycle Type Bit Definitions

Bits[3:2]	Bit1	Definition
00	0	I/O Read
00	1	I/O Write
01	0	Memory Read
01	1	Memory Read
10	0	DMA Read
10	1	DMA Write
11	x	Reserved. If a peripheral performing a bus master cycle generates this value, the PCH aborts the cycle.

5.4.1.4 Size

Bits[3:2] are reserved. The PCH always drives them to 00. Peripherals running bus master cycles are also supposed to drive 00 for Bits 3:2; however, the PCH ignores those bits. Bits[1:0] are encoded as listed in [Table 5-8](#).

Table 5-8. Transfer Size Bit Definition

Bits[1:0]	Size
00	8-bit transfer (1 byte)
01	16-bit transfer (2 bytes)
10	Reserved. The PCH never drives this combination. If a peripheral running a bus master cycle drives this combination, the PCH may abort the transfer.
11	32-bit transfer (4 bytes)

5.4.1.5 SYNC

Valid values for the SYNC field are shown in [Table 5-9](#).

Table 5-9. SYNC Bit Definition (Sheet 1 of 2)

Bits[3:0]	Indication
0000	Ready: SYNC achieved with no error. For DMA transfers, this also indicates DMA request deassertion and no more transfers desired for that channel.
0101	Short Wait: Part indicating wait-states. For bus master cycles, the PCH does not use this encoding. Instead, the PCH uses the Long Wait encoding (see next encoding below).
0110	Long Wait: Part indicating wait-states, and many wait-states will be added. This encoding driven by the PCH for bus master cycles, rather than the Short Wait (0101).
1001	Ready More (Used only by peripheral for DMA cycle): SYNC achieved with no error and more DMA transfers desired to continue after this transfer. This value is valid only on DMA transfers and is not allowed for any other type of cycle.

Table 5-9. SYNC Bit Definition (Sheet 2 of 2)

Bits[3:0]	Indication
1010	Error: Sync achieved with error. This is generally used to replace the SERR# or IOCHK# signal on the PCI/ISA bus. It indicates that the data is to be transferred, but there is a serious error in this transfer. For DMA transfers, this not only indicates an error, but also indicates DMA request deassertion and no more transfers desired for that channel.

NOTES:

1. All other combinations are RESERVED.
2. If the LPC controller receives any SYNC returned from the device other than short (0101), long wait (0110), or ready (0000) when running a FWH cycle, indeterminate results may occur. A FWH device is not allowed to assert an Error SYNC.

5.4.1.6 SYNC Time-Out

There are several error cases that can occur on the LPC interface. The PCH responds as defined in section 4.2.1.9 of the *Low Pin Count Interface Specification*, Revision 1.1 to the stimuli described therein. There may be other peripheral failure conditions; however, these are not handled by the PCH.

5.4.1.7 SYNC Error Indication

The PCH responds as defined in section 4.2.1.10 of the *Low Pin Count Interface Specification*, Revision 1.1.

Upon recognizing the SYNC field indicating an error, the PCH treats this as a SERR by reporting this into the Device 31 Error Reporting Logic.

5.4.1.8 LFRAME# Usage

The PCH follows the usage of LFRAME# as defined in the *Low Pin Count Interface Specification*, Revision 1.1.

The PCH performs an abort for the following cases (possible failure cases):

- The PCH starts a Memory, I/O, or DMA cycle, but no device drives a valid SYNC after four consecutive clocks.
- The PCH starts a Memory, I/O, or DMA cycle, and the peripheral drives an invalid SYNC pattern.
- A peripheral drives an illegal address when performing bus master cycles.
- A peripheral drives an invalid value.

5.4.1.9 I/O Cycles

For I/O cycles targeting registers specified in the PCH's decode ranges, the PCH performs I/O cycles as defined in the *Low Pin Count Interface Specification*, Revision 1.1. These are 8-bit transfers. If the processor attempts a 16-bit or 32-bit transfer, the PCH breaks the cycle up into multiple 8-bit transfers to consecutive I/O addresses.

Note: If the cycle is not claimed by any peripheral (and subsequently aborted), the PCH returns a value of all 1s (FFh) to the processor. This is to maintain compatibility with ISA I/O cycles where pull-up resistors would keep the bus high if no device responds.



5.4.1.10 Bus Master Cycles

The PCH supports Bus Master cycles and requests (using LDRQ#) as defined in the *Low Pin Count Interface Specification*, Revision 1.1. The PCH has two LDRQ# inputs, and thus supports two separate bus master devices. It uses the associated START fields for Bus Master 0 (0010b) or Bus Master 1 (0011b).

Note: The PCH does not support LPC Bus Masters performing I/O cycles. LPC Bus Masters should only perform memory read or memory write cycles.

5.4.1.11 LPC Power Management

LPCPD# Protocol

Same timings as for SUS_STAT#. Upon driving SUS_STAT# low, LPC peripherals drive LDRQ# low or tri-state it. The PCH shuts off the LDRQ# input buffers. After driving SUS_STAT# active, the PCH drives LFRAME# low, and tri-states (or drives low) LAD[3:0].

Note: The *Low Pin Count Interface Specification*, Revision 1.1 defines the LPCPD# protocol where there is at least 30 μ s from LPCPD# assertion to LRST# assertion. This specification explicitly states that this protocol only applies to entry/exit of low power states which does not include asynchronous reset events. The PCH asserts both SUS_STAT# (connects to LPCPD#) and PLTRST# (connects to LRST#) at the same time during a global reset. This is not inconsistent with the LPC LPCPD# protocol.

5.4.1.12 Configuration and PCH Implications

LPC I/F Decoders

To allow the I/O cycles and memory mapped cycles to go to the LPC interface, the PCH includes several decoders. During configuration, the PCH must be programmed with the same decode ranges as the peripheral. The decoders are programmed using the Device 31:Function 0 configuration space.

Note: The PCH cannot accept PCI write cycles from PCI-to-PCI bridges or devices with similar characteristics (specifically those with a "Retry Read" feature which is enabled) to an LPC device if there is an outstanding LPC read cycle towards the same PCI device or bridge. These cycles are not part of normal system operation, but may be encountered as part of platform validation testing using custom test fixtures.

Bus Master Device Mapping and START Fields

Bus Masters must have a unique START field. In the case of the PCH that supports two LPC bus masters, it drives 0010 for the START field for grants to Bus Master 0 (requested using LDRQ0#) and 0011 for grants to Bus Master 1 (requested using LDRQ1#). Thus, no registers are needed to configure the START fields for a particular bus master.



5.5 DMA Operation (D31:F0)

The PCH supports LPC DMA using the PCH's DMA controller. The DMA controller has registers that are fixed in the lower 64 KB of I/O space. The DMA controller is configured using registers in the PCI configuration space. These registers allow configuration of the channels for use by LPC DMA.

The DMA circuitry incorporates the functionality of two 82C37 DMA controllers with seven independently programmable channels (Figure 5-3). DMA Controller 1 (DMA-1) corresponds to DMA Channels 0–3 and DMA Controller 2 (DMA-2) corresponds to Channels 5–7. DMA Channel 4 is used to cascade the two controllers and defaults to cascade mode in the DMA Channel Mode (DCM) Register. Channel 4 is not available for any other purpose. In addition to accepting requests from DMA slaves, the DMA controller also responds to requests that software initiates. Software may initiate a DMA service request by setting any bit in the DMA Channel Request Register to a 1.

Figure 5-3. PCH DMA Controller

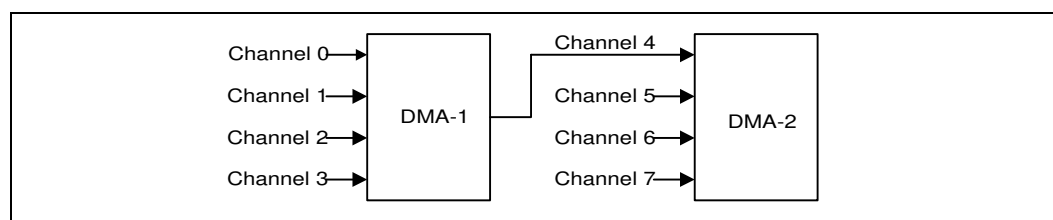

Each DMA channel is hardwired to the compatible settings for DMA device size: Channels [3:0] are hardwired to 8-bit, count-by-bytes transfers, and Channels [7:5] are hardwired to 16-bit, count-by-words (address shifted) transfers.

The PCH provides 24-bit addressing in compliance with the ISA-Compatible specification. Each channel includes a 16-bit ISA-Compatible Current Register which holds the sixteen least-significant bits of the 24-bit address, an ISA-Compatible Page Register which contains the eight next most significant bits of address.

The DMA controller also features refresh address generation, and auto-initialization following a DMA termination.

5.5.1 Channel Priority

For priority resolution, the DMA consists of two logical channel groups: Channels 0–3 and Channels 4–7. Each group may be in either fixed or rotate mode, as determined by the DMA Command Register.

DMA I/O slaves normally assert their DREQ line to arbitrate for DMA service. However, a software request for DMA service can be presented through each channel's DMA Request Register. A software request is subject to the same prioritization as any hardware request. See the detailed register description for Request Register programming information in [Section 13.2](#).

5.5.1.1 Fixed Priority

The initial fixed priority structure is as follows:

High priority	Low priority
0, 1, 2, 3	5, 6, 7

The fixed priority ordering is 0, 1, 2, 3, 5, 6, and 7. In this scheme, channel 0 has the highest priority, and channel 7 has the lowest priority. Channels [3:0] of DMA-1 assume the priority position of channel 4 in DMA-2, thus taking priority over Channels 5, 6, and 7.



5.5.1.2 Rotating Priority

Rotation allows for “fairness” in priority resolution. The priority chain rotates so that the last channel serviced is assigned the lowest priority in the channel group (0–3, 5–7).

Channels 0–3 rotate as a group of 4. They are always placed between Channel 5 and Channel 7 in the priority list.

Channel 5–7 rotate as part of a group of 4. That is, Channels (5–7) form the first three positions in the rotation, while Channel Group (0–3) comprises the fourth position in the arbitration.

5.5.2 Address Compatibility Mode

When the DMA is operating, the addresses do not increment or decrement through the High and Low Page Registers. Therefore, if a 24-bit address is 01FFFFh and increments, the next address is 010000h, not 020000h. Similarly, if a 24-bit address is 020000h and decrements, the next address is 02FFFFh, not 01FFFFh. However, when the DMA is operating in 16-bit mode, the addresses still do not increment or decrement through the High and Low Page Registers but the page boundary is now 128 K. Therefore, if a 24-bit address is 01FFFEh and increments, the next address is 000000h, not 0100000h. Similarly, if a 24-bit address is 020000h and decrements, the next address is 03FFFEh, not 02FFFEh. This is compatible with the 82C37 and Page Register implementation used in the PC-AT. This mode is set after CPURST is valid.

5.5.3 Summary of DMA Transfer Sizes

Table 5-10 lists each of the DMA device transfer sizes. The column labeled “Current Byte/Word Count Register” indicates that the register contents represents either the number of bytes to transfer or the number of 16-bit words to transfer. The column labeled “Current Address Increment/Decrement” indicates the number added to or taken from the Current Address register after each DMA transfer cycle. The DMA Channel Mode Register determines if the Current Address Register will be incremented or decremented.

5.5.3.1 Address Shifting When Programmed for 16-Bit I/O Count by Words

Table 5-10. DMA Transfer Size

DMA Device Data Size And Word Count	Current Byte/Word Count Register	Current Address Increment/Decrement
8-Bit I/O, Count By Bytes	Bytes	1
16-Bit I/O, Count By Words (Address Shifted)	Words	1

The PCH maintains compatibility with the implementation of the DMA in the PC AT that used the 82C37. The DMA shifts the addresses for transfers to/from a 16-bit device count-by-words.

Note: The least significant bit of the Low Page Register is dropped in 16-bit shifted mode. When programming the Current Address Register (when the DMA channel is in this mode), the Current Address must be programmed to an even address with the address value shifted right by one bit.



The address shifting is shown in Table 5-11.

Table 5-11. Address Shifting in 16-Bit I/O DMA Transfers

Output Address	8-Bit I/O Programmed Address (Ch 0-3)	16-Bit I/O Programmed Address (Ch 5-7) (Shifted)
A0 A[16:1] A[23:17]	A0 A[16:1] A[23:17]	0 A[15:0] A[23:17]

NOTE: The least significant bit of the Page Register is dropped in 16-bit shifted mode.

5.5.4 Autoinitialize

By programming a bit in the DMA Channel Mode Register, a channel may be set up as an autoinitialize channel. When a channel undergoes autoinitialization, the original values of the Current Page, Current Address and Current Byte/Word Count Registers are automatically restored from the Base Page, Address, and Byte/Word Count Registers of that channel following TC. The Base Registers are loaded simultaneously with the Current Registers by the microprocessor when the DMA channel is programmed and remain unchanged throughout the DMA service. The mask bit is not set when the channel is in autoinitialize. Following autoinitialize, the channel is ready to perform another DMA service, without processor intervention, as soon as a valid DREQ is detected.

5.5.5 Software Commands

There are three additional special software commands that the DMA controller can execute. The three software commands are:

- Clear Byte Pointer Flip-Flop
- Master Clear
- Clear Mask Register

They do not depend on any specific bit pattern on the data bus.

5.6 LPC DMA

DMA on LPC is handled through the use of the LDRQ# lines from peripherals and special encodings on LAD[3:0] from the host. Single, Demand, Verify, and Increment modes are supported on the LPC interface. Channels 0–3 are 8-bit channels. Channels 5–7 are 16-bit channels. Channel 4 is reserved as a generic bus master request.

5.6.1 Asserting DMA Requests

Peripherals that need DMA service encode their requested channel number on the LDRQ# signal. To simplify the protocol, each peripheral on the LPC I/F has its own dedicated LDRQ# signal (they may not be shared between two separate peripherals). The PCH has two LDRQ# inputs, allowing at least two devices to support DMA or bus mastering.

LDRQ# is synchronous with LCLK (PCI clock). As shown in Figure 5-4, the peripheral uses the following serial encoding sequence:

- Peripheral starts the sequence by asserting LDRQ# low (start bit). LDRQ# is high during idle conditions.
- The next three bits contain the encoded DMA channel number (MSB first).
- The next bit (ACT) indicates whether the request for the indicated DMA channel is active or inactive. The ACT bit is 1 (high) to indicate if it is active and 0 (low) if it is inactive. The case where ACT is low is rare, and is only used to indicate that a previous request for that channel is being abandoned.
- After the active/inactive indication, the LDRQ# signal must go high for at least one clock. After that one clock, LDRQ# signal can be brought low to the next encoding sequence.

If another DMA channel also needs to request a transfer, another sequence can be sent on LDRQ#. For example, if an encoded request is sent for Channel 2, and then Channel 3 needs a transfer before the cycle for Channel 2 is run on the interface, the peripheral can send the encoded request for Channel 3. This allows multiple DMA agents behind an I/O device to request use of the LPC interface, and the I/O device does not need to self-arbitrate before sending the message.

Figure 5-4. DMA Request Assertion through LDRQ#

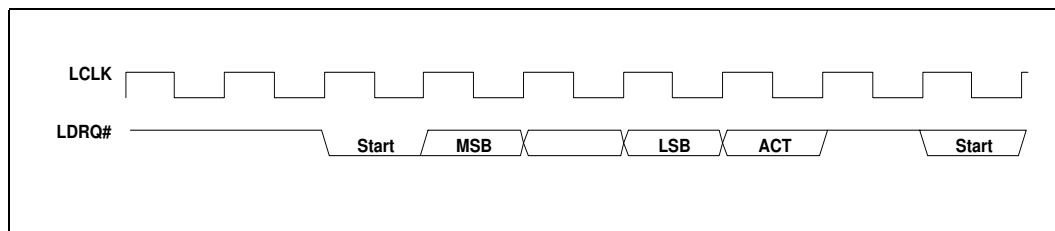



5.6.2 Abandoning DMA Requests

DMA Requests can be deasserted in two fashions: on error conditions by sending an LDRQ# message with the 'ACT' bit set to 0, or normally through a SYNC field during the DMA transfer. This section describes boundary conditions where the DMA request needs to be removed prior to a data transfer.

There may be some special cases where the peripheral desires to abandon a DMA transfer. The most likely case of this occurring is due to a floppy disk controller which has overrun or underrun its FIFO, or software stopping a device prematurely.

In these cases, the peripheral wishes to stop further DMA activity. It may do so by sending an LDRQ# message with the ACT bit as 0. However, since the DMA request was seen by the PCH, there is no assurance that the cycle has not been granted and will shortly run on LPC. Therefore, peripherals must take into account that a DMA cycle may still occur. The peripheral can choose not to respond to this cycle, in which case the host will abort it, or it can choose to complete the cycle normally with any random data.

This method of DMA deassertion should be prevented whenever possible, to limit boundary conditions both on the PCH and the peripheral.

5.6.3 General Flow of DMA Transfers

Arbitration for DMA channels is performed through the 8237 within the host. Once the host has won arbitration on behalf of a DMA channel assigned to LPC, it asserts LFRAME# on the LPC I/F and begins the DMA transfer. The general flow for a basic DMA transfer is as follows:

1. The PCH starts transfer by asserting 0000b on LAD[3:0] with LFRAME# asserted.
2. The PCH asserts 'cycle type' of DMA, direction based on DMA transfer direction.
3. The PCH asserts channel number and, if applicable, terminal count.
4. The PCH indicates the size of the transfer: 8 or 16 bits.
5. If a DMA read...
 - The PCH drives the first 8 bits of data and turns the bus around.
 - The peripheral acknowledges the data with a valid SYNC.
 - If a 16-bit transfer, the process is repeated for the next 8 bits.
6. If a DMA write...
 - The PCH turns the bus around and waits for data.
 - The peripheral indicates data ready through SYNC and transfers the first byte.
 - If a 16-bit transfer, the peripheral indicates data ready and transfers the next byte.
7. The peripheral turns around the bus.

5.6.4 Terminal Count

Terminal count is communicated through LAD[3] on the same clock that DMA channel is communicated on LAD[2:0]. This field is the CHANNEL field. Terminal count indicates the last byte of transfer, based upon the size of the transfer.

For example, on an 8-bit transfer size (SIZE field is 00b), if the TC bit is set, then this is the last byte. On a 16-bit transfer (SIZE field is 01b), if the TC bit is set, then the second byte is the last byte. The peripheral, therefore, must internalize the TC bit when the CHANNEL field is communicated, and only signal TC when the last byte of that transfer size has been transferred.

5.6.5 Verify Mode

Verify mode is supported on the LPC interface. A verify transfer to the peripheral is similar to a DMA write, where the peripheral is transferring data to main memory. The indication from the host is the same as a DMA write, so the peripheral will be driving data onto the LPC interface. However, the host will not transfer this data into main memory.

5.6.6 DMA Request Deassertion

An end of transfer is communicated to the PCH through a special SYNC field transmitted by the peripheral. An LPC device must not attempt to signal the end of a transfer by deasserting LDREQ#. If a DMA transfer is several bytes (such as, a transfer from a demand mode device) the PCH needs to know when to deassert the DMA request based on the data currently being transferred.

The DMA agent uses a SYNC encoding on each byte of data being transferred, which indicates to the PCH whether this is the last byte of transfer or if more bytes are requested. To indicate the last byte of transfer, the peripheral uses a SYNC value of 0000b (ready with no error), or 1010b (ready with error). These encodings tell the PCH that this is the last piece of data transferred on a DMA read (PCH to peripheral), or the byte that follows is the last piece of data transferred on a DMA write (peripheral to the PCH).

When the PCH sees one of these two encodings, it ends the DMA transfer after this byte and deasserts the DMA request to the 8237. Therefore, if the PCH indicated a 16-bit transfer, the peripheral can end the transfer after one byte by indicating a SYNC value of 0000b or 1010b. The PCH does not attempt to transfer the second byte, and deasserts the DMA request internally.

If the peripheral indicates a 0000b or 1010b SYNC pattern on the last byte of the indicated size, then the PCH only deasserts the DMA request to the 8237 since it does not need to end the transfer.

If the peripheral wishes to keep the DMA request active, then it uses a SYNC value of 1001b (ready plus more data). This tells the 8237 that more data bytes are requested after the current byte has been transferred, so the PCH keeps the DMA request active to the 8237. Therefore, on an 8-bit transfer size, if the peripheral indicates a SYNC value of 1001b to the PCH, the data will be transferred and the DMA request will remain active to the 8237. At a later time, the PCH will then come back with another START-CYCTYPE-CHANNEL-SIZE etc. combination to initiate another transfer to the peripheral.

The peripheral must not assume that the next START indication from the PCH is another grant to the peripheral if it had indicated a SYNC value of 1001b. On a single mode DMA device, the 8237 will re-arbitrate after every transfer. Only demand mode DMA devices can be assured that they will receive the next START indication from the PCH.

Note: Indicating a 0000b or 1010b encoding on the SYNC field of an odd byte of a 16-bit channel (first byte of a 16-bit transfer) is an error condition.

Note: The host stops the transfer on the LPC bus as indicated, fills the upper byte with random data on DMA writes (peripheral to memory), and indicates to the 8237 that the DMA transfer occurred, incrementing the 8237's address and decrementing its byte count.



5.6.7 SYNC Field / LDRQ# Rules

Since DMA transfers on LPC are requested through an LDRQ# assertion message, and are ended through a SYNC field during the DMA transfer, the peripheral must obey the following rule when initiating back-to-back transfers from a DMA channel.

The peripheral must not assert another message for eight LCLKs after a deassertion is indicated through the SYNC field. This is needed to allow the 8237, that typically runs off a much slower internal clock, to see a message deasserted before it is re-asserted so that it can arbitrate to the next agent.

Under default operation, the host only performs 8-bit transfers on 8-bit channels and 16-bit transfers on 16-bit channels.

The method by which this communication between host and peripheral through system BIOS is performed is beyond the scope of this specification. Since the LPC host and LPC peripheral are motherboard devices, no “plug-n-play” registry is required.

The peripheral must not assume that the host is able to perform transfer sizes that are larger than the size allowed for the DMA channel, and be willing to accept a SIZE field that is smaller than what it may currently have buffered.

To that end, it is recommended that future devices that may appear on the LPC bus, that require higher bandwidth than 8-bit or 16-bit DMA allow, do so with a bus mastering interface and not rely on the 8237.

5.7 8254 Timers (D31:F0)

The PCH contains three counters that have fixed uses. All registers and functions associated with the 8254 timers are in the core well. The 8254 unit is clocked by a 14.31818 MHz clock.

Counter 0, System Timer

This counter functions as the system timer by controlling the state of IRQ0 and is typically programmed for Mode 3 operation. The counter produces a square wave with a period equal to the product of the counter period (838 ns) and the initial count value. The counter loads the initial count value 1 counter period after software writes the count value to the counter I/O address. The counter initially asserts IRQ0 and decrements the count value by two each counter period. The counter negates IRQ0 when the count value reaches 0. It then reloads the initial count value and again decrements the initial count value by two each counter period. The counter then asserts IRQ0 when the count value reaches 0, reloads the initial count value, and repeats the cycle, alternately asserting and negating IRQ0.

Counter 1, Refresh Request Signal

This counter provides the refresh request signal and is typically programmed for Mode 2 operation and only impacts the period of the REF_TOGGLE bit in Port 61. The initial count value is loaded one counter period after being written to the counter I/O address. The REF_TOGGLE bit will have a square wave behavior (alternate between 0 and 1) and will toggle at a rate based on the value in the counter. Programming the counter to anything other than Mode 2 will result in undefined behavior for the REF_TOGGLE bit.

Counter 2, Speaker Tone

This counter provides the speaker tone and is typically programmed for Mode 3 operation. The counter provides a speaker frequency equal to the counter clock frequency (1.193 MHz) divided by the initial count value. The speaker must be enabled by a write to port 061h (see NMI Status and Control ports).

5.7.1 Timer Programming

The counter/timers are programmed in the following fashion:

1. Write a control word to select a counter.
2. Write an initial count for that counter.
3. Load the least and/or most significant bytes (as required by Control Word Bits 5, 4) of the 16-bit counter.
4. Repeat with other counters.

Only two conventions need to be observed when programming the counters. First, for each counter, the control word must be written before the initial count is written. Second, the initial count must follow the count format specified in the control word (least significant byte only, most significant byte only, or least significant byte and then most significant byte).

A new initial count may be written to a counter at any time without affecting the counter's programmed mode. Counting is affected as described in the mode definitions. The new count must follow the programmed count format.

If a counter is programmed to read/write two-byte counts, the following precaution applies: A program must not transfer control between writing the first and second byte to another routine which also writes into that same counter. Otherwise, the counter will be loaded with an incorrect count.

The Control Word Register at port 43h controls the operation of all three counters. Several commands are available:

- **Control Word Command.** Specifies which counter to read or write, the operating mode, and the count format (binary or BCD).
- **Counter Latch Command.** Latches the current count so that it can be read by the system. The countdown process continues.
- **Read Back Command.** Reads the count value, programmed mode, the current state of the OUT pins, and the state of the Null Count Flag of the selected counter.

Table 5-12 lists the six operating modes for the interval counters.

Table 5-12. Counter Operating Modes

Mode	Function	Description
0	Out signal on end of count (=0)	Output is 0. When count goes to 0, output goes to 1 and stays at 1 until counter is reprogrammed.
1	Hardware retriggerable one-shot	Output is 0. When count goes to 0, output goes to 1 for one clock time.
2	Rate generator (divide by n counter)	Output is 1. Output goes to 0 for one clock time, then back to 1 and counter is reloaded.
3	Square wave output	Output is 1. Output goes to 0 when counter rolls over, and counter is reloaded. Output goes to 1 when counter rolls over, and counter is reloaded, etc.
4	Software triggered strobe	Output is 1. Output goes to 0 when count expires for one clock time.
5	Hardware triggered strobe	Output is 1. Output goes to 0 when count expires for one clock time.



5.7.2 Reading from the Interval Timer

It is often desirable to read the value of a counter without disturbing the count in progress. There are three methods for reading the counters: a simple read operation, counter Latch command, and the Read-Back command. Each is explained below.

With the simple read and counter latch command methods, the count must be read according to the programmed format; specifically, if the counter is programmed for two byte counts, two bytes must be read. The two bytes do not have to be read one right after the other. Read, write, or programming operations for other counters may be inserted between them.

5.7.2.1 Simple Read

The first method is to perform a simple read operation. The counter is selected through Port 40h (Counter 0), 41h (Counter 1), or 42h (Counter 2).

Note: Performing a direct read from the counter does not return a determinate value, because the counting process is asynchronous to read operations. However, in the case of Counter 2, the count can be stopped by writing to the GATE bit in Port 61h.

5.7.2.2 Counter Latch Command

The Counter Latch command, written to Port 43h, latches the count of a specific counter at the time the command is received. This command is used to ensure that the count read from the counter is accurate, particularly when reading a two-byte count. The count value is then read from each counter's Count register as was programmed by the Control register.

The count is held in the latch until it is read or the counter is reprogrammed. The count is then unlatched. This allows reading the contents of the counters on the fly without affecting counting in progress. Multiple Counter Latch Commands may be used to latch more than one counter. Counter Latch commands do not affect the programmed mode of the counter in any way.

If a Counter is latched and then, some time later, latched again before the count is read, the second Counter Latch command is ignored. The count read is the count at the time the first Counter Latch command was issued.

5.7.2.3 Read Back Command

The Read Back command, written to Port 43h, latches the count value, programmed mode, and current states of the OUT pin and Null Count flag of the selected counter or counters. The value of the counter and its status may then be read by I/O access to the counter address.

The Read Back command may be used to latch multiple counter outputs at one time. This single command is functionally equivalent to several counter latch commands, one for each counter latched. Each counter's latched count is held until it is read or reprogrammed. Once read, a counter is unlatched. The other counters remain latched until they are read. If multiple count Read Back commands are issued to the same counter without reading the count, all but the first are ignored.

The Read Back command may additionally be used to latch status information of selected counters. The status of a counter is accessed by a read from that counter's I/O port address. If multiple counter status latch operations are performed without reading the status, all but the first are ignored.

Both count and status of the selected counters may be latched simultaneously. This is functionally the same as issuing two consecutive, separate Read Back commands. If multiple count and/or status Read Back commands are issued to the same counters without any intervening reads, all but the first are ignored.

If both count and status of a counter are latched, the first read operation from that counter returns the latched status, regardless of which was latched first. The next one or two reads, depending on whether the counter is programmed for one or two type counts, returns the latched count. Subsequent reads return unlatched count.

5.8 8259 Interrupt Controllers (PIC) (D31:F0)

The PCH incorporates the functionality of two 8259 interrupt controllers that provide system interrupts for the ISA compatible interrupts. These interrupts are: system timer, keyboard controller, serial ports, parallel ports, floppy disk, mouse, and DMA channels. In addition, this interrupt controller can support the PCI based interrupts, by mapping the PCI interrupt onto the compatible ISA interrupt line. Each 8259 core supports eight interrupts, numbered 0–7. [Table 5-13](#) shows how the cores are connected.

Table 5-13. Interrupt Controller Core Connections

8259	8259 Input	Typical Interrupt Source	Connected Pin / Function
Master	0	Internal	Internal Timer / Counter 0 output / HPET #0
	1	Keyboard	IRQ1 using SERIRQ
	2	Internal	Slave controller INTR output
	3	Serial Port A	IRQ3 using SERIRQ, PIRQ#
	4	Serial Port B	IRQ4 using SERIRQ, PIRQ#
	5	Parallel Port / Generic	IRQ5 using SERIRQ, PIRQ#
	6	Floppy Disk	IRQ6 using SERIRQ, PIRQ#
	7	Parallel Port / Generic	IRQ7 using SERIRQ, PIRQ#
Slave	0	Internal Real Time Clock	Internal RTC / HPET #1
	1	Generic	IRQ9 using SERIRQ, SCI, TCO, or PIRQ#
	2	Generic	IRQ10 using SERIRQ, SCI, TCO, or PIRQ#
	3	Generic	IRQ11 using SERIRQ, SCI, TCO, or PIRQ#, or HPET #2
	4	PS/2 Mouse	IRQ12 using SERIRQ, SCI, TCO, or PIRQ#, or HPET #3
	5	Internal	State Machine output based on processor FERR# assertion. May optionally be used for SCI or TCO interrupt if FERR# not needed.
	6	SATA	SATA Primary (legacy mode), or using SERIRQ or PIRQ#
	7	SATA	SATA Secondary (legacy mode) or using SERIRQ or PIRQ#

The PCH cascades the slave controller onto the master controller through master controller interrupt input 2. This means there are only 15 possible interrupts for the PCH PIC.



Interrupts can individually be programmed to be edge or level, except for IRQ0, IRQ2, IRQ8#, and IRQ13.

Note: Active-low interrupt sources (such as, the PIRQ#s) are inverted inside the PCH. In the following descriptions of the 8259s, the interrupt levels are in reference to the signals at the internal interface of the 8259s, after the required inversions have occurred. Therefore, the term “high” indicates “active,” which means “low” on an originating PIRQ#.

5.8.1 Interrupt Handling

5.8.1.1 Generating Interrupts

The PIC interrupt sequence involves three bits, from the IRR, ISR, and IMR, for each interrupt level. These bits are used to determine the interrupt vector returned, and status of any other pending interrupts. Table 5-14 defines the IRR, ISR, and IMR.

Table 5-14. Interrupt Status Registers

Bit	Description
IRR	Interrupt Request Register. This bit is set on a low to high transition of the interrupt line in edge mode, and by an active high level in level mode. This bit is set whether or not the interrupt is masked. However, a masked interrupt will not generate INTR.
ISR	Interrupt Service Register. This bit is set, and the corresponding IRR bit cleared, when an interrupt acknowledge cycle is seen, and the vector returned is for that interrupt.
IMR	Interrupt Mask Register. This bit determines whether an interrupt is masked. Masked interrupts will not generate INTR.

5.8.1.2 Acknowledging Interrupts

The processor generates an interrupt acknowledge cycle that is translated by the host bridge into a PCI Interrupt Acknowledge Cycle to the PCH. The PIC translates this command into two internal INTA# pulses expected by the 8259 cores. The PIC uses the first internal INTA# pulse to freeze the state of the interrupts for priority resolution. On the second INTA# pulse, the master or slave sends the interrupt vector to the processor with the acknowledged interrupt code. This code is based upon Bits [7:3] of the corresponding ICW2 register, combined with three bits representing the interrupt within that controller.

Table 5-15. Content of Interrupt Vector Byte

Master, Slave Interrupt	Bits [7:3]	Bits [2:0]
IRQ7,15	ICW2[7:3]	111
IRQ6,14		110
IRQ5,13		101
IRQ4,12		100
IRQ3,11		011
IRQ2,10		010
IRQ1,9		001
IRQ0,8		000

5.8.1.3 Hardware/Software Interrupt Sequence

1. One or more of the Interrupt Request lines (IRQ) are raised high in edge mode, or seen high in level mode, setting the corresponding IRR bit.
2. The PIC sends INTR active to the processor if an asserted interrupt is not masked.
3. The processor acknowledges the INTR and responds with an interrupt acknowledge cycle. The cycle is translated into a PCI interrupt acknowledge cycle by the host bridge. This command is broadcast over PCI by the PCH.
4. Upon observing its own interrupt acknowledge cycle on PCI, the PCH converts it into the two cycles that the internal 8259 pair can respond to. Each cycle appears as an interrupt acknowledge pulse on the internal INTA# pin of the cascaded interrupt controllers.
5. Upon receiving the first internally generated INTA# pulse, the highest priority ISR bit is set and the corresponding IRR bit is reset. On the trailing edge of the first pulse, a slave identification code is broadcast by the master to the slave on a private, internal three bit wide bus. The slave controller uses these bits to determine if it must respond with an interrupt vector during the second INTA# pulse.
6. Upon receiving the second internally generated INTA# pulse, the PIC returns the interrupt vector. If no interrupt request is present because the request was too short in duration, the PIC returns vector 7 from the master controller.
7. This completes the interrupt cycle. In AEOI mode the ISR bit is reset at the end of the second INTA# pulse. Otherwise, the ISR bit remains set until an appropriate EOI command is issued at the end of the interrupt subroutine.

5.8.2 Initialization Command Words (ICWx)

Before operation can begin, each 8259 must be initialized. In the PCH, this is a four byte sequence. The four initialization command words are referred to by their acronyms: ICW1, ICW2, ICW3, and ICW4.

The base address for each 8259 initialization command word is a fixed location in the I/O memory space: 20h for the master controller, and A0h for the slave controller.

5.8.2.1 ICW1

An I/O write to the master or slave controller base address with data bit 4 equal to 1 is interpreted as a write to ICW1. Upon sensing this write, the PCH's PIC expects three more byte writes to 21h for the master controller, or A1h for the slave controller, to complete the ICW sequence.

A write to ICW1 starts the initialization sequence during which the following automatically occur:

1. Following initialization, an interrupt request (IRQ) input must make a low-to-high transition to generate an interrupt.
2. The Interrupt Mask Register is cleared.
3. IRQ7 input is assigned priority 7.
4. The slave mode address is set to 7.
5. Special mask mode is cleared and Status Read is set to IRR.



5.8.2.2 ICW2

The second write in the sequence (ICW2) is programmed to provide bits [7:3] of the interrupt vector that will be released during an interrupt acknowledge. A different base is selected for each interrupt controller.

5.8.2.3 ICW3

The third write in the sequence (ICW3) has a different meaning for each controller.

- For the master controller, ICW3 is used to indicate which IRQ input line is used to cascade the slave controller. Within the PCH, IRQ2 is used. Therefore, Bit 2 of ICW3 on the master controller is set to a 1, and the other bits are set to 0s.
- For the slave controller, ICW3 is the slave identification code used during an interrupt acknowledge cycle. On interrupt acknowledge cycles, the master controller broadcasts a code to the slave controller if the cascaded interrupt won arbitration on the master controller. The slave controller compares this identification code to the value stored in its ICW3, and if it matches, the slave controller assumes responsibility for broadcasting the interrupt vector.

5.8.2.4 ICW4

The final write in the sequence (ICW4) must be programmed for both controllers. At the very least, Bit 0 must be set to a 1 to indicate that the controllers are operating in an Intel Architecture-based system.

5.8.3 Operation Command Words (OCW)

These command words reprogram the Interrupt controller to operate in various interrupt modes.

- OCW1 masks and unmasks interrupt lines.
- OCW2 controls the rotation of interrupt priorities when in rotating priority mode, and controls the EOI function.
- OCW3 sets up ISR/IRR reads, enables/disables the special mask mode (SMM), and enables/disables polled interrupt mode.

5.8.4 Modes of Operation

5.8.4.1 Fully Nested Mode

In this mode, interrupt requests are ordered in priority from 0 through 7, with 0 being the highest. When an interrupt is acknowledged, the highest priority request is determined and its vector placed on the bus. Additionally, the ISR for the interrupt is set. This ISR bit remains set until: the processor issues an EOI command immediately before returning from the service routine; or if in AEIOI mode, on the trailing edge of the second INTA#. While the ISR bit is set, all further interrupts of the same or lower priority are inhibited, while higher levels generate another interrupt. Interrupt priorities can be changed in the rotating priority mode.

5.8.4.2 Special Fully-Nested Mode

This mode is used in the case of a system where cascading is used, and the priority has to be conserved within each slave. In this case, the special fully-nested mode is programmed to the master controller. This mode is similar to the fully-nested mode with the following exceptions:

- When an interrupt request from a certain slave is in service, this slave is not locked out from the master's priority logic and further interrupt requests from higher priority interrupts within the slave are recognized by the master and initiate interrupts to the processor. In the normal-nested mode, a slave is masked out when its request is in service.
- When exiting the Interrupt Service routine, software has to check whether the interrupt serviced was the only one from that slave. This is done by sending a Non-Specific EOI command to the slave and then reading its ISR. If it is 0, a non-specific EOI can also be sent to the master.

5.8.4.3 Automatic Rotation Mode (Equal Priority Devices)

In some applications, there are a number of interrupting devices of equal priority. Automatic rotation mode provides for a sequential 8-way rotation. In this mode, a device receives the lowest priority after being serviced. In the worst case, a device requesting an interrupt has to wait until each of seven other devices are serviced at most once.

There are two ways to accomplish automatic rotation using OCW2; the Rotation on Non-Specific EOI Command (R=1, SL=0, EOI=1) and the rotate in automatic EOI mode which is set by (R=1, SL=0, EOI=0).

5.8.4.4 Specific Rotation Mode (Specific Priority)

Software can change interrupt priorities by programming the bottom priority. For example, if IRQ5 is programmed as the bottom priority device, then IRQ6 is the highest priority device. The Set Priority Command is issued in OCW2 to accomplish this, where: R=1, SL=1, and LO-L2 is the binary priority level code of the bottom priority device.

In this mode, internal status is updated by software control during OCW2. However, it is independent of the EOI command. Priority changes can be executed during an EOI command by using the Rotate on Specific EOI Command in OCW2 (R=1, SL=1, EOI=1 and LO-L2=IRQ level to receive bottom priority).

5.8.4.5 Poll Mode

Poll mode can be used to conserve space in the interrupt vector table. Multiple interrupts that can be serviced by one interrupt service routine do not need separate vectors if the service routine uses the poll command. Poll mode can also be used to expand the number of interrupts. The polling interrupt service routine can call the appropriate service routine, instead of providing the interrupt vectors in the vector table. In this mode, the INTR output is not used and the microprocessor internal Interrupt Enable flip-flop is reset, disabling its interrupt input. Service to devices is achieved by software using a Poll command.

The Poll command is issued by setting P=1 in OCW3. The PIC treats its next I/O read as an interrupt acknowledge, sets the appropriate ISR bit if there is a request, and reads the priority level. Interrupts are frozen from the OCW3 write to the I/O read. The byte returned during the I/O read contains a 1 in Bit 7 if there is an interrupt, and the binary code of the highest priority level in Bits 2:0.



5.8.4.6 Cascade Mode

The PIC in the PCH has one master 8259 and one slave 8259 cascaded onto the master through IRQ2. This configuration can handle up to 15 separate priority levels. The master controls the slaves through a three bit internal bus. In the PCH, when the master drives 010b on this bus, the slave controller takes responsibility for returning the interrupt vector. An EOI command must be issued twice: once for the master and once for the slave.

5.8.4.7 Edge and Level Triggered Mode

In ISA systems this mode is programmed using Bit 3 in ICW1, which sets level or edge for the entire controller. In the PCH, this bit is disabled and a new register for edge and level triggered mode selection, per interrupt input, is included. This is the Edge/Level control Registers ELCR1 and ELCR2.

If an ELCR bit is 0, an interrupt request will be recognized by a low-to-high transition on the corresponding IRQ input. The IRQ input can remain high without generating another interrupt. If an ELCR bit is 1, an interrupt request will be recognized by a high level on the corresponding IRQ input and there is no need for an edge detection. The interrupt request must be removed before the EOI command is issued to prevent a second interrupt from occurring.

In both the edge and level triggered modes, the IRQ inputs must remain active until after the falling edge of the first internal INTA#. If the IRQ input goes inactive before this time, a default IRQ7 vector is returned.

5.8.4.8 End of Interrupt (EOI) Operations

An EOI can occur in one of two fashions: by a command word write issued to the PIC before returning from a service routine, the EOI command; or automatically when AEOI bit in ICW4 is set to 1.

5.8.4.9 Normal End of Interrupt

In normal EOI, software writes an EOI command before leaving the interrupt service routine to mark the interrupt as completed. There are two forms of EOI commands: Specific and Non-Specific. When a Non-Specific EOI command is issued, the PIC clears the highest ISR bit of those that are set to 1. Non-Specific EOI is the normal mode of operation of the PIC within the PCH, as the interrupt being serviced currently is the interrupt entered with the interrupt acknowledge. When the PIC is operated in modes that preserve the fully nested structure, software can determine which ISR bit to clear by issuing a Specific EOI. An ISR bit that is masked is not cleared by a Non-Specific EOI if the PIC is in the special mask mode. An EOI command must be issued for both the master and slave controller.

5.8.4.10 Automatic End of Interrupt Mode

In this mode, the PIC automatically performs a Non-Specific EOI operation at the trailing edge of the last interrupt acknowledge pulse. From a system standpoint, this mode should be used only when a nested multi-level interrupt structure is not required within a single PIC. The AEOI mode can only be used in the master controller and not the slave controller.

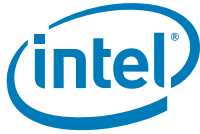

5.8.5 Masking Interrupts

5.8.5.1 Masking on an Individual Interrupt Request

Each interrupt request can be masked individually by the Interrupt Mask Register (IMR). This register is programmed through OCW1. Each bit in the IMR masks one interrupt channel. Masking IRQ2 on the master controller masks all requests for service from the slave controller.

5.8.5.2 Special Mask Mode

Some applications may require an interrupt service routine to dynamically alter the system priority structure during its execution under software control. For example, the routine may wish to inhibit lower priority requests for a portion of its execution but enable some of them for another portion.

The special mask mode enables all interrupts not masked by a bit set in the Mask register. Normally, when an interrupt service routine acknowledges an interrupt without issuing an EOI to clear the ISR bit, the interrupt controller inhibits all lower priority requests. In the special mask mode, any interrupts may be selectively enabled by loading the Mask Register with the appropriate pattern. The special mask mode is set by OCW3 where: SSMM=1, SMM=1, and cleared where SSMM=1, SMM=0.

5.8.6 Steering PCI Interrupts

The PCH can be programmed to allow PIRQA#-PIRQH# to be routed internally to interrupts 3-7, 9-12, 14 or 15. The assignment is programmable through the PIRQx Route Control registers, located at 60-63h and 68-6Bh in Device 31:Function 0. One or more PIRQx# lines can be routed to the same IRQx input. If interrupt steering is not required, the Route registers can be programmed to disable steering.

The PIRQx# lines are defined as active low, level sensitive to allow multiple interrupts on a PCI board to share a single line across the connector. When a PIRQx# is routed to specified IRQ line, software must change the IRQ's corresponding ELCR bit to level sensitive mode. The PCH internally inverts the PIRQx# line to send an active high level to the PIC. When a PCI interrupt is routed onto the PIC, the selected IRQ can no longer be used by an active high device (through SERIRQ). However, active low interrupts can share their interrupt with PCI interrupts.

Internal sources of the PIRQs, including SCI and TCO interrupts, cause the external PIRQ to be asserted. The PCH receives the PIRQ input, like all of the other external sources, and routes it accordingly.



5.9 Advanced Programmable Interrupt Controller (APIC) (D31:F0)

In addition to the standard ISA-compatible PIC described in the previous chapter, the PCH incorporates the APIC. While the standard interrupt controller is intended for use in a uni-processor system, APIC can be used in either a uni-processor or multi-processor system.

5.9.1 Interrupt Handling

The I/O APIC handles interrupts very differently than the 8259. Briefly, these differences are:

- **Method of Interrupt Transmission.** The I/O APIC transmits interrupts through memory writes on the normal data path to the processor, and interrupts are handled without the need for the processor to run an interrupt acknowledge cycle.
- **Interrupt Priority.** The priority of interrupts in the I/O APIC is independent of the interrupt number. For example, interrupt 10 can be given a higher priority than interrupt 3.
- **More Interrupts.** The I/O APIC in the PCH supports a total of 24 interrupts.
- **Multiple Interrupt Controllers.** The I/O APIC architecture allows for multiple I/O APIC devices in the system with their own interrupt vectors.

5.9.2 Interrupt Mapping

The I/O APIC within the PCH supports 24 APIC interrupts. Each interrupt has its own unique vector assigned by software. The interrupt vectors are mapped as follows, and match "Config 6" of the *Multi-Processor Specification*.

Table 5-16. APIC Interrupt Mapping¹ (Sheet 1 of 2)

IRQ #	Using SERIRQ	Direct from Pin	Using PCI Message	Internal Modules
0	No	No	No	Cascade from 8259 #1
1	Yes	No	Yes	
2	No	No	No	8254 Counter 0, HPET #0 (legacy mode)
3	Yes	No	Yes	
4	Yes	No	Yes	
5	Yes	No	Yes	
6	Yes	No	Yes	
7	Yes	No	Yes	
8	No	No	No	RTC, HPET #1 (legacy mode)
9	Yes	No	Yes	Option for SCI, TCO
10	Yes	No	Yes	Option for SCI, TCO
11	Yes	No	Yes	HPET #2, Option for SCI, TCO (Note2)
12	Yes	No	Yes	HPET #3 (Note 3)
13	No	No	No	FERR# logic
14	Yes	No	Yes	SATA Primary (legacy mode)
15	Yes	No	Yes	SATA Secondary (legacy mode)

Table 5-16. APIC Interrupt Mapping¹ (Sheet 2 of 2)

IRQ #	Using SERIRQ	Direct from Pin	Using PCI Message	Internal Modules
16	PIRQA#	PIRQA#	Yes	Internal devices are routable; see Section 10.1.20 though Section 10.1.34 .
17	PIRQB#	PIRQB#		
18	PIRQC#	PIRQC#		
19	PIRQD#	PIRQD#		
20	N/A	PIRQE# ⁴	Yes	Option for SCI, TCO, HPET #0,1,2, 3. Other internal devices are routable; see Section 10.1.20 though Section 10.1.34 .
21	N/A	PIRQF# ⁴		
22	N/A	PIRQG# ⁴		
23	N/A	PIRQH# ⁴		

NOTES:

- When programming the polarity of internal interrupt sources on the APIC, interrupts 0 through 15 receive active-high internal interrupt sources, while interrupts 16 through 23 receive active-low internal interrupt sources.
- If IRQ 11 is used for HPET #2, software should ensure IRQ 11 is not shared with any other devices to ensure the proper operation of HPET #2. The PCH hardware does not prevent sharing of IRQ 11.
- If IRQ 12 is used for HPET #3, software should ensure IRQ 12 is not shared with any other devices to ensure the proper operation of HPET #3. The PCH hardware does not prevent sharing of IRQ 12.
- PIRQ[E:H] are Multiplexed with GPIO pins. Interrupts PIRQ[E:H] will not be exposed if they are configured as GPIOs.

5.9.3 PCI / PCI Express* Message-Based Interrupts

When external devices through PCI/PCI Express wish to generate an interrupt, they will send the message defined in the *PCI Express* Base Specification*, Revision 1.0a for generating INTA# – INTD#. These will be translated internal assertions/deassertions of INTA# – INTD#.

5.9.4 IOxAPIC Address Remapping

To support Intel® Virtualization Technology, interrupt messages are required to go through similar address remapping as any other memory request. Address remapping allows for domain isolation for interrupts, so a device assigned in one domain is not allowed to generate an interrupt to another domain.

The address remapping is based on the Bus: Device: Function field associated with the requests. The internal APIC is required to initiate the interrupt message using a unique Bus: Device: function.

The PCH allows BIOS to program the unique Bus: Device: Function address for the internal APIC. This address field does not change the APIC functionality and the APIC is not promoted as a stand-alone PCI device. See Device 31: Function 0 Offset 6Ch for additional information.

5.9.5 External Interrupt Controller Support

The PCH supports external APICs off of PCI Express ports but does not support APICs on the PCI bus. The EOI special cycle is only forwarded to PCI Express ports.



5.10 Serial Interrupt (D31:F0)

The PCH supports a serial IRQ scheme. This allows a single signal to be used to report interrupt requests. The signal used to transmit this information is shared between the host, the PCH, and all peripherals that support serial interrupts. The signal line, SERIRQ, is synchronous to PCI clock, and follows the sustained tri-state protocol that is used by all PCI signals. This means that if a device has driven SERIRQ low, it will first drive it high synchronous to PCI clock and release it the following PCI clock. The serial IRQ protocol defines this sustained tri-state signaling in the following fashion:

- **S – Sample Phase.** Signal driven low
- **R – Recovery Phase.** Signal driven high
- **T – Turn-around Phase.** Signal released

The PCH supports a message for 21 serial interrupts. These represent the 15 ISA interrupts (IRQ0–1, 2–15), the four PCI interrupts, and the control signals SMI# and IOCHK#. The serial IRQ protocol does not support the additional APIC interrupts (20–23).

Note: When the SATA controller is configured for legacy IDE mode, IRQ14 and IRQ15 are expected to behave as ISA legacy interrupts that cannot be shared (that is, through the Serial Interrupt pin). If IRQ14 and IRQ15 are shared with Serial Interrupt pin then abnormal system behavior may occur. For example, IRQ14/15 may not be detected by the PCH's interrupt controller. When the SATA controller is not running in Native IDE mode, IRQ14 and IRQ15 are used as special interrupts. If the SATA controller is in native mode, these interrupts can be mapped to other devices accordingly.

5.10.1 Start Frame

The serial IRQ protocol has two modes of operation which affect the start frame. These two modes are: Continuous, where the PCH is solely responsible for generating the start frame; and Quiet, where a serial IRQ peripheral is responsible for beginning the start frame.

The mode that must first be entered when enabling the serial IRQ protocol is continuous mode. In this mode, the PCH asserts the start frame. This start frame is 4, 6, or 8 PCI clocks wide based upon the Serial IRQ Control Register, bits 1:0 at 64h in Device 31:Function 0 configuration space. This is a polling mode.

When the serial IRQ stream enters quiet mode (signaled in the Stop Frame), the SERIRQ line remains inactive and pulled up between the Stop and Start Frame until a peripheral drives the SERIRQ signal low. The PCH senses the line low and continues to drive it low for the remainder of the Start Frame. Since the first PCI clock of the start frame was driven by the peripheral in this mode, the PCH drives the SERIRQ line low for 1 PCI clock less than in continuous mode. This mode of operation allows for a quiet, and therefore lower power, operation.

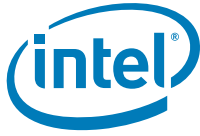

5.10.2 Data Frames

Once the Start frame has been initiated, all of the SERIRQ peripherals must start counting frames based on the rising edge of SERIRQ. Each of the IRQ/DATA frames has exactly 3 phases of 1 clock each:

- **Sample Phase.** During this phase, the SERIRQ device drives SERIRQ low if the corresponding interrupt signal is low. If the corresponding interrupt is high, then the SERIRQ devices tri-state the SERIRQ signal. The SERIRQ line remains high due to pull-up resistors (there is no internal pull-up resistor on this signal, an external pull-up resistor is required). A low level during the IRQ0–1 and IRQ2–15 frames indicates that an active-high ISA interrupt is not being requested, but a low level during the PCI INT[A:D], SMI#, and IOCHK# frame indicates that an active-low interrupt is being requested.
- **Recovery Phase.** During this phase, the device drives the SERIRQ line high if in the Sample Phase it was driven low. If it was not driven in the sample phase, it is tri-stated in this phase.
- **Turn-around Phase.** The device tri-states the SERIRQ line

5.10.3 Stop Frame

After all data frames, a Stop Frame is driven by the PCH. The SERIRQ signal is driven low by the PCH for 2 or 3 PCI clocks. The number of clocks is determined by the SERIRQ configuration register. The number of clocks determines the next mode.

Table 5-17. Stop Frame Explanation

Stop Frame Width	Next Mode
2 PCI clocks	Quiet Mode. Any SERIRQ device may initiate a Start Frame
3 PCI clocks	Continuous Mode. Only the host (the PCH) may initiate a Start Frame

5.10.4 Specific Interrupts Not Supported Using SERIRQ

There are three interrupts seen through the serial stream that are not supported by the PCH. These interrupts are generated internally, and are not sharable with other devices within the system. These interrupts are:

- IRQ0. Heartbeat interrupt generated off of the internal 8254 counter 0.
- IRQ8#. RTC interrupt can only be generated internally.
- IRQ13. Floating point error interrupt generated off of the processor assertion of FERR#.

The PCH ignores the state of these interrupts in the serial stream, and does not adjust their level based on the level seen in the serial stream.



5.10.5 Data Frame Format

Table 5-18 shows the format of the data frames. For the PCI interrupts (A–D), the output from the PCH is AND'd with the PCI input signal. This way, the interrupt can be signaled using both the PCI interrupt input signal and using the SERIRQ signal (they are shared).

Table 5-18. Data Frame Format

Data Frame #	Interrupt	Clocks Past Start Frame	Comment
1	IRQ0	2	Ignored. IRQ0 can only be generated using the internal 8524
2	IRQ1	5	
3	SMI#	8	Causes SMI# if low. Will set the SERIRQ_SMI_STS bit.
4	IRQ3	11	
5	IRQ4	14	
6	IRQ5	17	
7	IRQ6	20	
8	IRQ7	23	
9	IRQ8	26	Ignored. IRQ8# can only be generated internally.
10	IRQ9	29	
11	IRQ10	32	
12	IRQ11	35	
13	IRQ12	38	
14	IRQ13	41	Ignored. IRQ13 can only be generated from FERR#
15	IRQ14	44	Not attached to SATA logic
16	IRQ15	47	Not attached to SATA logic
17	IOCHCK#	50	Same as ISA IOCHCK# going active.
18	PCI INTA#	53	Drive PIRQA#
19	PCI INTB#	56	Drive PIRQB#
20	PCI INTC#	59	Drive PIRQC#
21	PCI INTD#	62	Drive PIRQD#

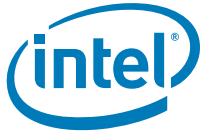

5.11 Real Time Clock (D31:F0)

The Real Time Clock (RTC) module provides a battery backed-up date and time keeping device with two banks of static RAM with 128 bytes each, although the first bank has 114 bytes for general purpose usage. Three interrupt features are available: time of day alarm with once a second to once a month range, periodic rates of 122 μ s to 500 ms, and end of update cycle notification. Seconds, minutes, hours, days, day of week, month, and year are counted. Daylight savings compensation is no longer supported. The hour is represented in twelve or twenty-four hour format, and data can be represented in BCD or binary format. The design is functionally compatible with the Motorola MS146818B. The time keeping comes from a 32.768 kHz oscillating source, which is divided to achieve an update every second. The lower 14 bytes on the lower RAM block has very specific functions. The first ten are for time and date information. The next four (0Ah to 0Dh) are registers, which configure and report RTC functions.

The time and calendar data should match the data mode (BCD or binary) and hour mode (12 or 24 hour) as selected in register B. It is up to the programmer to make sure that data stored in these locations is within the reasonable values ranges and represents a possible date and time. The exception to these ranges is to store a value of C0–FFh in the Alarm bytes to indicate a don't care situation. All Alarm conditions must match to trigger an Alarm Flag, which could trigger an Alarm Interrupt if enabled. The SET bit must be 1 while programming these locations to avoid clashes with an update cycle. Access to time and date information is done through the RAM locations. If a RAM read from the ten time and date bytes is attempted during an update cycle, the value read do not necessarily represent the true contents of those locations. Any RAM writes under the same conditions are ignored.

Note: The leap year determination for adding a 29th day to February does not take into account the end-of-the-century exceptions. The logic simply assumes that all years divisible by 4 are leap years. According to the Royal Observatory Greenwich, years that are divisible by 100 are typically not leap years. In every fourth century (years divisible by 400, like 2000), the 100-year-exception is over-ridden and a leap-year occurs. Note that the year 2100 will be the first time in which the current RTC implementation would incorrectly calculate the leap-year.

The PCH does not implement month/year alarms.

5.11.1 Update Cycles

An update cycle occurs once a second, if the SET bit of register B is not asserted and the divide chain is properly configured. During this procedure, the stored time and date are incremented, overflow is checked, a matching alarm condition is checked, and the time and date are rewritten to the RAM locations. The update cycle will start at least 488 μ s after the UIP bit of register A is asserted, and the entire cycle does not take more than 1984 μ s to complete. The time and date RAM locations (0–9) are disconnected from the external bus during this time.

To avoid update and data corruption conditions, external RAM access to these locations can safely occur at two times. When a updated-ended interrupt is detected, almost 999 ms is available to read and write the valid time and date data. If the UIP bit of Register A is detected to be low, there is at least 488 μ s before the update cycle begins.

Warning: The overflow conditions for leap years adjustments are based on more than one date or time item. To ensure proper operation when adjusting the time, the new time and data values should be set at least two seconds before leap year occurs.



5.11.2 Interrupts

The real-time clock interrupt is internally routed within the PCH both to the I/O APIC and the 8259. It is mapped to interrupt vector 8. This interrupt does not leave the PCH, nor is it shared with any other interrupt. IRQ8# from the SERIRQ stream is ignored. However, the High Performance Event Timers can also be mapped to IRQ8#; in this case, the RTC interrupt is blocked.

5.11.3 Lockable RAM Ranges

The RTC battery-backed RAM supports two 8-byte ranges that can be locked using the configuration space. If the locking bits are set, the corresponding range in the RAM will not be readable or writable. A write cycle to those locations will have no effect. A read cycle to those locations will not return the location's actual value (resultant value is undefined).

Once a range is locked, the range can be unlocked only by a hard reset, which will invoke the BIOS and allow it to relock the RAM range.

5.11.4 Century Rollover

The PCH detects a rollover when the Year byte (RTC I/O space, index Offset 09h) transitions from 99 to 00. Upon detecting the rollover, the PCH sets the NEWCENTURY_STS bit (TCOBASE + 04h, Bit 7). If the system is in an S0 state, this causes an SMI#. The SMI# handler can update registers in the RTC RAM that are associated with century value. If the system is in a sleep state (S1–S5) when the century rollover occurs, the PCH also sets the NEWCENTURY_STS bit, but no SMI# is generated. When the system resumes from the sleep state, BIOS should check the NEWCENTURY_STS bit and update the century value in the RTC RAM.

5.11.5 Clearing Battery-Backed RTC RAM

Clearing CMOS RAM in a PCH-based platform can be done by using a jumper on RTCRST# or GPI. Implementations should not attempt to clear CMOS by using a jumper to pull VccRTC low.

Using RTCRST# to Clear CMOS

A jumper on RTCRST# can be used to clear CMOS values, as well as reset to default, the state of those configuration bits that reside in the RTC power well. When the RTCRST# is strapped to ground, the RTC_PWR_STS bit (D31:F0:A4h Bit 2) will be set and those configuration bits in the RTC power well will be set to their default state. BIOS can monitor the state of this Bit, and manually clear the RTC CMOS array once the system is booted. The normal position would cause RTCRST# to be pulled up through a weak pull-up resistor. Table 5-19 shows which bits are set to their default state when RTCRST# is asserted. This RTCRST# jumper technique allows the jumper to be moved and then replaced—all while the system is powered off. Then, once booted, the RTC_PWR_STS can be detected in the set state.

Table 5-19. Configuration Bits Reset by RTCRST# Assertion

Bit Name	Register	Location	Bit(s)	Default State
Alarm Interrupt Enable (AIE)	Register B (General Configuration) (RTC_REGB)	I/O space (RTC Index + 0Bh)	5	X
Alarm Flag (AF)	Register C (Flag Register) (RTC_REGC)	I/O space (RTC Index + 0Ch)	5	X
SWSMI_RATE_SEL	General PM Configuration 3 Register GEN_PMCON_3	D31:F0:A4h	7:6	0
SLP_S4# Minimum Assertion Width	General PM Configuration 3 Register GEN_PMCON_3	D31:F0:A4h	5:4	0
SLP_S4# Assertion Stretch Enable	General PM Configuration 3 Register GEN_PMCON_3	D31:F0:A4h	3	0
RTC Power Status (RTC_PWR_STS)	General PM Configuration 3 Register GEN_PMCON_3	D31:F0:A4h	2	0
Power Failure (PWR_FLR)	General PM Configuration 3 Register (GEN_PMCON_3)	D31:F0:A4h	1	0
AFTERG3_EN	General PM Configuration 3 Register GEN_PMCON_3	D31:F0:A4h	0	0
Power Button Override Status (PRBTNOR_STS)	Power Management 1 Status Register (PM1_STS)	PMBase + 00h	11	0
RTC Event Enable (RTC_EN)	Power Management 1 Enable Register (PM1_EN)	PMBase + 02h	10	0
Sleep Type (SLP_TYP)	Power Management 1 Control (PM1_CNT)	PMBase + 04h	12:10	0
PME_EN	General Purpose Event 0 Enables Register (GPE0_EN)	PMBase + 2Ch	11	0
BATLOW_EN	General Purpose Event 0 Enables Register (GPE0_EN)	PMBase + 2Ch	10	0
RI_EN	General Purpose Event 0 Enables Register (GPE0_EN)	PMBase + 2Ch	8	0
NEWCENTURY_STS	TCO1 Status Register (TCO1_STS)	TCOBase + 04h	7	0
Intruder Detect (INTRD_DET)	TCO2 Status Register (TCO2_STS)	TCOBase + 06h	0	0
Top Swap (TS)	Backed Up Control Register (BUC)	Chipset Config Registers:Offset 3414h	0	X

Using a GPI to Clear CMOS

A jumper on a GPI can also be used to clear CMOS values. BIOS would detect the setting of this GPI on system boot-up, and manually clear the CMOS array.

Note: The GPI strap technique to clear CMOS requires multiple steps to implement. The system is booted with the jumper in new position, then powered back down. The jumper is replaced back to the normal position, then the system is rebooted again.

Warning: Do not implement a jumper on VccRTC to clear CMOS.



5.12 Processor Interface (D31:F0)

The PCH interfaces to the processor with following pin-based signals other than DMI:

- Standard Outputs to processor: PROCPWRGD, PMSYNCH, PECI
- Standard Input from processor: THRMTRIP#

Most PCH outputs to the processor use standard buffers. The PCH has separate V_PROC_IO signals that are pulled up at the system level to the processor voltage, and thus determines VOH for the outputs to the processor.

The following processor interface legacy pins were removed from the PCH:

- IGNNE#, STPCLK#, DPSP#, and DPRSLPVR are no longer required on PCH based systems.
- A20M#, SMI#, NMI, INIT#, INTR, FERR#: Functionality has been replaced by in-band Virtual Legacy Wire (VLW) messages. See [Section 5.12.3](#).

5.12.1 Processor Interface Signals and VLW Messages

This section describes each of the signals that interface between the PCH and the processor(s). Note that the behavior of some signals may vary during processor reset, as the signals are used for frequency strapping.

5.12.1.1 A20M# (Mask A20) / A20GATE

The A20M# VLW message is asserted when both of the following conditions are true:

- The ALT_A20_GATE bit (Bit 1 of PORT92 register) is a 0
- The A20GATE input signal is a 0

The A20GATE input signal is expected to be generated by the external microcontroller (KBC).



5.12.1.2 INIT (Initialization)

The INIT# VLW Message is asserted based on any one of several events described in Table 5-20. When any of these events occur, INIT# is asserted for 16 PCI clocks, then driven high.

Note: INIT3_3V# is functionally identical to INIT# VLW but it is a physical signal at 3.3 V on desktop SKUs only.

Table 5-20. INIT# Going Active

Cause of INIT3_3V# Going Active	Comment
Shutdown special cycle from processor observed on PCH-processor interconnect.	INIT assertion based on value of Shutdown Policy Select register (SPS)
PORT92 write, where INIT_NOW (Bit 0) transitions from a 0 to a 1.	
PORTCF9 write, where SYS_RST (Bit 1) was a 0 and RST_CPU (Bit 2) transitions from 0 to 1.	
RCIN# input signal goes low. RCIN# is expected to be driven by the external microcontroller (KBC).	0 to 1 transition on RCIN# must occur before the PCH will arm INIT3_3V# to be generated again. NOTE: RCIN# signal is expected to be low during S3, S4, and S5 states. Transition on the RCIN# signal in those states (or the transition to those states) may not necessarily cause the INIT3_3V# signal to be generated to the processor.
Processor BIST	To enter BIST, software sets CPU_BIST_EN bit and then does a full processor reset using the CF9 register.

5.12.1.3 FERR# (Numeric Coprocessor Error)

The PCH supports the coprocessor error function with the FERR# message. The function is enabled using the COPROC_ERR_EN bit. If FERR# is driven active by the processor, IRQ13 goes active (internally). When it detects a write to the COPROC_ERR register (I/O Register F0h), the PCH negates the internal IRQ13 and IGNNE# will be active. IGNNE# remains active until FERR# is driven inactive. IGNNE# is never driven active unless FERR# is active.

Note: IGNNE# (Ignore Numeric Error is now internally generated by the processor.



5.12.1.4 NMI (Non-Maskable Interrupt)

Non-Maskable Interrupts (NMIs) can be generated by several sources, as described in Table 5-21.

Table 5-21. NMI Sources

Cause of NMI	Comment
SERR# goes active (either internally, externally using SERR# signal, or using message from processor)	Can instead be routed to generate an SCI, through the NMI2SCI_EN bit (Device 31:Function 0, TCO Base + 08h, Bit 11).
IOCHK# goes active using SERIRQ# stream (ISA system Error)	Can instead be routed to generate an SCI, through the NMI2SCI_EN bit (Device 31:Function 0, TCO Base + 08h, Bit 11).
SECSTS Register Device 31: Function F0 Offset 1Eh, bit 8.	This is enabled by the Parity Error Response Bit (PER) at Device 30: Function 0 Offset 04, bit 6.
DEV_STS Register Device 31:Function F0 Offset 06h, bit 8	This is enabled by the Parity Error Response Bit (PER) at Device 30: Function 0 Offset 04, bit 6.
GPIO[15:0] when configured as a General Purpose input and routed as NMI (by GPIO_ROUT at Device 31: Function 0 Offset B8)	This is enabled by GPI NMI Enable (GPI_NMI_EN) bits at Device 31: Function 0 Offset: GPIOBASE + 28h bits 15:0

5.12.1.5 Processor Power Good (PROCPWRGD)

This signal is connected to the processor's UNCOREPWRGOOD input to indicate when the processor power is valid.

5.12.2 Dual-Processor Issues

5.12.2.1 Usage Differences

In dual-processor designs, some of the processor signals are unused or used differently than for uniprocessor designs.

- A20M#/A20GATE and FERR# are generally not used, but still supported.
- I/O APIC and SMI# are assumed to be used.

5.12.3 Virtual Legacy Wire (VLW) Messages

The PCH supports VLW messages as alternative method of conveying the status of the following legacy sideband interface signals to the processor:

- A20M#, INTR, SMI#, INIT#, NMI

Note: IGNNE# VLW message is not required to be generated by the PCH as it is internally emulated by the processor.

VLW are inbound messages to the processor. They are communicated using Vendor Defined Message over the DMI link.

Legacy processor signals can only be delivered using VLW in the PCH. Delivery of legacy processor signals (A20M#, INTR, SMI#, INIT# or NMI) using I/O APIC controller is not supported.

5.13 Power Management

5.13.1 Features

- Support for *Advanced Configuration and Power Interface, Version 4.0a (ACPI)* providing power and thermal management
 - ACPI 24-Bit Timer SCI and SMI# Generation
- PCI PME# signal for Wake Up from Low-Power states
- System Sleep State Control
 - ACPI S3 state – Suspend to RAM (STR)
 - ACPI S4 state – Suspend-to-Disk (STD)
 - ACPI G2/S5 state – Soft Off (SOFF)
 - Power Failure Detection and Recovery
 - Deep S4/S5
- Intel® Management Engine Power Management Support
 - Wake events from the Intel Management Engine (enabled from all S-States including Catastrophic S5 conditions)

5.13.2 PCH and System Power States

Table 5-22 shows the power states defined for PCH-based platforms. The state names generally match the corresponding ACPI states.

Table 5-22. General Power States for Systems Using the PCH (Sheet 1 of 2)

State/ Substates	Legacy Name / Description
G0/S0/C0	Full On: Processor operating. Individual devices may be shut down or be placed into lower power states to save power.
G0/S0/Cx	Cx State: Cx states are processor power states within the S0 system state that provide for various levels of power savings. The processor initiates C-state entry and exit while interacting with the PCH. The PCH will base its behavior on the processor state.
G1/S1	S1: The PCH provides the S1 messages and the S0 messages on a wake event. It is preferred for systems to use C-states than S1.
G1/S3	Suspend-To-RAM (STR): The system context is maintained in system DRAM, but power is shut off to non-critical circuits. Memory is retained and refreshes continue. All external clocks stop except RTC.
G1/S4	Suspend-To-Disk (STD): The context of the system is maintained on the disk. All power is then shut off to the system except for the logic required to resume.
G2/S5	Soft Off (SOFF): System context is not maintained. All power is shut off except for the logic required to restart. A full boot is required when waking.
Deep S4/S5	Deep S4/S5: An optional low power state where system context may or may not be maintained depending upon entry condition. All power is shut off except for minimal logic that allows exiting Deep S4/S5. If Deep S4/S5 state was entered from S4 state, then the resume path will place system back into S4. If Deep S4/S5 state was entered from S5 state, then the resume path will place system back into S5.

**Table 5-22. General Power States for Systems Using the PCH (Sheet 2 of 2)**

State/ Substates	Legacy Name / Description
G3	Mechanical OFF (MOFF): System context not maintained. All power is shut off except for the RTC. No "Wake" events are possible. This state occurs if the user removes the main system batteries in a mobile system, turns off a mechanical switch, or if the system power supply is at a level that is insufficient to power the "waking" logic. When system power returns, transition will depend on the state just prior to the entry to G3 and the AFTERG3_EN bit in the GEN_PMCON3 register (D31:F0, offset A4). Refer to Table 5-29 for more details.

[Table 5-23](#) shows the transitions rules among the various states. Note that transitions among the various states may appear to temporarily transition through intermediate states. For example, in going from S0 to S3, it may appear to pass through the G1/S1 states. These intermediate transitions and states are not listed in the table.

Table 5-23. State Transition Rules for the PCH

Present State	Transition Trigger	Next State
G0/S0/C0	<ul style="list-style-type: none"> • DMI Msg • SLP_EN bit set • Power Button Override³ • Mechanical Off/Power Failure 	<ul style="list-style-type: none"> • G0/S0/Cx • G1/Sx or G2/S5 state • G2/S5 • G3
G0/S0/Cx	<ul style="list-style-type: none"> • DMI Msg • Power Button Override³ • Mechanical Off/Power Failure 	<ul style="list-style-type: none"> • G0/S0/C0 • S5 • G3
G1/S1 or G1/S3	<ul style="list-style-type: none"> • Any Enabled Wake Event • Power Button Override³ • Mechanical Off/Power Failure 	<ul style="list-style-type: none"> • G0/S0/C0² • G2/S5 • G3
G1/S4	<ul style="list-style-type: none"> • Any Enabled Wake Event • Power Button Override³ • Conditions met as described in Section 5.13.7.6.1 and Section 5.13.7.6.2 • Mechanical Off/Power Failure 	<ul style="list-style-type: none"> • G0/S0/C0² • G2/S5 • Deep S4/S5 • G3
G2/S5	<ul style="list-style-type: none"> • Any Enabled Wake Event • Conditions met as described in Section 5.13.7.6.1 and Section 5.13.7.6.2 • Mechanical Off/Power Failure 	<ul style="list-style-type: none"> • G0/S0/C0² • Deep S4/S5 • G3
G2/Deep S4/S5	<ul style="list-style-type: none"> • Any Enabled Wake Event • ACPRESENT Assertion • Mechanical Off/Power Failure 	<ul style="list-style-type: none"> • G0/S0/C0² • G1/S4 or G2/S5 (see Section 5.13.7.6.2) • G3
G3	<ul style="list-style-type: none"> • Power Returns 	<ul style="list-style-type: none"> • S0/C0 (reboot) or G2/S5⁴ (stay off until power button pressed or other wake event)^{1,2}

NOTES:

1. Some wake events can be preserved through power failure.
2. Transitions from the S1–S5 or G3 states to the S0 state are deferred until BATLOW# is inactive in mobile configurations.
3. Includes all other applicable types of events that force the host into and stay in G2/S5.
4. If the system was in G1/S4 before G3 entry, then the system will go to S0/C0 or G1/S4.

5.13.3 System Power Planes

The system has several independent power planes, as described in [Table 5-24](#). Note that when a particular power plane is shut off, it should go to a 0 V level.

Table 5-24. System Power Plane

Plane	Controlled By	Description
Processor	SLP_S3# signal	The SLP_S3# signal can be used to cut the power to the processor completely.
Main	SLP_S3# signal	When SLP_S3# goes active, power can be shut off to any circuit not required to wake the system from the S3 state. Since the S3 state requires that the memory context be preserved, power must be retained to the main memory. The processor, devices on the PCI bus, LPC I/F, and graphics will typically be shut off when the Main power plane is off, although there may be small subsections powered.
Memory	SLP_S4# signal SLP_S5# signal	When SLP_S4# goes active, power can be shut off to any circuit not required to wake the system from the S4. Since the memory context does not need to be preserved in the S4 state, the power to the memory can also be shut down. When SLP_S5# goes active, power can be shut off to any circuit not required to wake the system from the S5 state. Since the memory context does not need to be preserved in the S5 state, the power to the memory can also be shut.
Intel® ME	SLP_A#	This signal is asserted when the manageability platform goes to MOff. Depending on the platform, this pin may be used to control the Intel Management Engine power planes, LAN subsystem power, and the SPI flash power.
LAN	SLP_LAN#	This signal is asserted in Sx/Moff when both host and Intel ME WOL are not supported. This signal can be use to control power to the Intel GbE PHY.
Deep S4/ S5 Well	SLP_SUS#	This signal that the Sus rails externally can be shut off for enhanced power saving.
DEVICE[n]	Implementation Specific	Individual subsystems may have their own power plane. For example, GPIO signals may be used to control the power to disk drives, audio amplifiers, or the display screen.



5.13.4 SMI#/SCI Generation

Upon any enabled SMI event taking place while the End of SMI (EOS) bit is set, the PCH will clear the EOS bit and assert SMI to the processor, which will cause it to enter SMM space. SMI assertion is performed using a Virtual Legacy Wire (VLW) message. Prior system generations (those based upon legacy processors) used an actual SMI# pin.

Once the SMI VLW has been delivered, the PCH takes no action on behalf of active SMI events until Host software sets the End of SMI (EOS) bit. At that point, if any SMI events are still active, the PCH will send another SMI VLW message.

The SCI is a level-mode interrupt that is typically handled by an ACPI-aware operating system. In non-APIC systems (which is the default), the SCI IRQ is routed to one of the 8259 interrupts (IRQ 9, 10, or 11). The 8259 interrupt controller must be programmed to level mode for that interrupt.

In systems using the APIC, the SCI can be routed to interrupts 9, 10, 11, 20, 21, 22, or 23. The interrupt polarity changes depending on whether it is on an interrupt shareable with a PIRQ or not (see [Section 13.1.13](#)). The interrupt remains asserted until all SCI sources are removed.

[Table 5-25](#) shows which events can cause an SMI and SCI. Note that some events can be programmed to cause either an SMI or SCI. The usage of the event for SCI (instead of SMI) is typically associated with an ACPI-based system. Each SMI or SCI source has a corresponding enable and status bit.

Table 5-25. Causes of SMI and SCI (Sheet 1 of 2)

Cause	SCI	SMI	Additional Enables	Where Reported
PME#	Yes	Yes	PME_EN=1	PME_STS
PME_B0 (Internal, Bus 0, PME-Capable Agents)	Yes	Yes	PME_B0_EN=1	PME_B0_STS
PCI Express* PME Messages	Yes	Yes	PCI_EXP_EN=1 (Not enabled for SMI)	PCI_EXP_STS
PCI Express Hot Plug Message	Yes	Yes	HOT_PLUG_EN=1 (Not enabled for SMI)	HOT_PLUG_STS
Power Button Press	Yes	Yes	PWRBTN_EN=1	PWRBTN_STS
Power Button Override (Note 7)	Yes	No	None	PRBTNOR_STS
RTC Alarm	Yes	Yes	RTC_EN=1	RTC_STS
Ring Indicate	Yes	Yes	RI_EN=1	RI_STS
ACPI Timer overflow (2.34 sec.)	Yes	Yes	TMROF_EN=1	TMROF_STS
Any GPI[15:0]	Yes	Yes	GPI[x]_Route=10; GPI[x]_EN=1 (SCI) GPI[x]_Route=01; ALT_GPI_SMI[x]_EN=1 (SMI)	GPI[x]_STS ALT_GPI_SMI[x]_STS
GPIO[27]	Yes	Yes	GP27_EN=1	GP27_STS
TCO SCI Logic	Yes	No	TCOSCI_EN=1	TCOSCI_STS
TCO SCI message from processor	Yes	No	none	CPUSCI_STS
TCO SMI Logic	No	Yes	TCO_EN=1	TCO_STS
TCO SMI –	No	Yes	none	NEWCENTURY_STS
TCO SMI – TCO TIMEROUT	No	Yes	none	TIMEOUT
TCO SMI – OS writes to TCO_DAT_IN register	No	Yes	none	OS_TCO_SMI

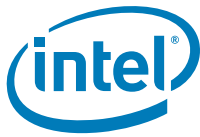

Table 5-25. Causes of SMI and SCI (Sheet 2 of 2)

Cause	SCI	SMI	Additional Enables	Where Reported
TCO SMI – Message from processor	No	Yes	none	CPUSMI_STS
TCO SMI – NMI occurred (and NMIs mapped to SMI)	No	Yes	NMI2SMI_EN=1	NMI2SMI_STS
TCO SMI – INTRUDER# signal goes active	No	Yes	INTRD_SEL=10	INTRD_DET
TCO SMI – Change of the BIOSWE (D31:F0:DCh, Bit 0) bit from 0 to 1	No	Yes	BLE=1	BIOSWR_STS
TCO SMI – Write attempted to BIOS	No	Yes	BIOSWE=1	BIOSWR_STS
BIOS_RLS written to	Yes	No	GBL_EN=1	GBL_STS
GBL_RLS written to	No	Yes	BIOS_EN=1	BIOS_STS
Write to B2h register	No	Yes	APMC_EN = 1	APM_STS
Periodic timer expires	No	Yes	PERIODIC_EN=1	PERIODIC_STS
64 ms timer expires	No	Yes	SWSMI_TMR_EN=1	SWSMI_TMR_STS
Enhanced USB Legacy Support Event	No	Yes	LEGACY_USB2_EN = 1	LEGACY_USB2_STS
Enhanced USB Intel Specific Event	No	Yes	INTEL_USB2_EN = 1	INTEL_USB2_STS
Serial IRQ SMI reported	No	Yes	none	SERIRQ_SMI_STS
Device monitors match address in its range	No	Yes	none	DEVTRAP_STS
SMBus Host Controller	No	Yes	SMB_SMI_EN Host Controller Enabled	SMBus host status reg.
SMBus Slave SMI message	No	Yes	none	SMBUS_SMI_STS
SMBus SMBALERT# signal active	No	Yes	none	SMBUS_SMI_STS
SMBus Host Notify message received	No	Yes	HOST_NOTIFY_INTREN	SMBUS_SMI_STS HOST_NOTIFY_STS
(Mobile Only) BATLOW# assertion	Yes	Yes	BATLOW_EN=1	BATLOW_STS
Access microcontroller 62h/66h	No	Yes	MCSMI_EN	MCSMI_STS
SLP_EN bit written to 1	No	Yes	SMI_ON_SLP_EN=1	SMI_ON_SLP_EN_STS
SPI Command Completed	No	Yes	None	SPI_SMI_STS
Software Generated GPE	Yes	Yes	SWGPE=1	SWGPE_STS
USB Per-Port Registers Write Enable bit changes to 1	No	Yes	USB2_EN=1, Write_Enable_SMI_Enable=1	USB2_STS, Write Enable Status
GPIO Lockdown Enable bit changes from '1' to '0'	No	Yes	GPIO_UNLOCK_SMI_EN=1	GPIO_UNLOCK_SMI_STS

NOTES:

1. SCI_EN must be 1 to enable SCI, except for BIOS_RLS. SCI_EN must be 0 to enable SMI.
2. SCI can be routed to cause interrupt 9:11 or 20:23 (20:23 only available in APIC mode).
3. GBL_SMI_EN must be 1 to enable SMI.
4. EOS must be written to 1 to re-enable SMI for the next 1.
5. The PCH must have SMI fully enabled when the PCH is also enabled to trap cycles. If SMI is not enabled in conjunction with the trap enabling, then hardware behavior is undefined.
6. Only GPI[15:0] may generate an SMI or SCI.
7. When a power button override first occurs, the system will transition immediately to S5. The SCI will only occur after the next wake to S0 if the residual status bit (PRBTNOR_STS) is not cleared prior to setting SCI_EN.
8. GBL_STS being set will cause an SCI, even if the SCI_EN bit is not set. Software must take great care not to set the BIOS_RLS bit (which causes GBL_STS to be set) if the SCI handler is not in place.



5.13.4.1 PCI Express* SCI

PCI Express ports and the processor (using DMI) have the ability to cause PME using messages. When a PME message is received, the PCH will set the PCI_EXP_STS bit. If the PCI_EXP_EN bit is also set, the PCH can cause an SCI using the GPE1_STS register.

5.13.4.2 PCI Express* Hot-Plug

PCI Express has a Hot-Plug mechanism and is capable of generating a SCI using the GPE1 register. It is also capable of generating an SMI. However, it is not capable of generating a wake event.

5.13.5 C-States

PCH-based systems implement C-states by having the processor control the states. The chipset exchanges messages with the processor as part of the C-state flow, but the chipset does not directly control any of the processor impacts of C-states, such as voltage levels or processor clocking. In addition to the new messages, the PCH also provides additional information to the processor using a sideband pin (PMSYNCH). All of the legacy C-state related pins (STPCLK#, STP_CPU#, DPRSLP#, DPRSLPVR#, etc.) do not exist on the PCH.

5.13.6 Dynamic PCI Clock Control (Mobile Only)

The PCI clock can be dynamically controlled independent of any other low-power state. This control is accomplished using the CLKRUN# protocol as described in the PCI Mobile Design Guide, and is transparent to software.

The Dynamic PCI Clock control is handled using the following signals:

- CLKRUN#: Used by PCI and LPC peripherals to request the system PCI clock to run
- STP_PCI#: Used to stop the system PCI clock

Note: The 33-MHz clock to the PCH is “free-running” and is not affected by the STP_PCI# signal.

Note: STP_PCI# is only used if PCI/LPC clocks are distributed from clock synthesizer rather than PCH.

5.13.6.1 Conditions for Checking the PCI Clock

When there is a lack of PCI activity the PCH has the capability to stop the PCI clocks to conserve power. “PCI activity” is defined as any activity that would require the PCI clock to be running.

Any of the following conditions will indicate that it is **not okay** to stop the PCI clock:

- Cycles on PCI or LPC
- Cycles of any internal device that would need to go on the PCI bus
- SERIRQ activity

Behavioral Description

- When there is a lack of activity (as defined above) for 29 PCI clocks, the PCH deasserts (drive high) CLKRUN# for 1 clock and then tri-states the signal.

5.13.6.2 Conditions for Maintaining the PCI Clock

PCI masters or LPC devices that wish to maintain the PCI clock running will observe the CLKRUN# signal deasserted, and then must re-assert if (drive it low) within 3 clocks.

- When the PCH has tri-stated the CLKRUN# signal after deasserting it, the PCH then checks to see if the signal has been re-asserted (externally).
- After observing the CLKRUN# signal asserted for 1 clock, the PCH again starts asserting the signal.
- If an internal device needs the PCI bus, the PCH asserts the CLKRUN# signal.

5.13.6.3 Conditions for Stopping the PCI Clock

- If no device re-asserts CLKRUN# once it has been deasserted for at least 6 clocks, the PCH stops the PCI clock by asserting the STP_PCI# signal to the clock synthesizer.
- For case when PCH distribute PCI clock, PCH stop PCI clocks without the involvement of STP_PCI#.

5.13.6.4 Conditions for Re-Starting the PCI Clock

- A peripheral asserts CLKRUN# to indicate that it needs the PCI clock re-started.
- When the PCH observes the CLKRUN# signal asserted for 1 (free running) clock, the PCH deasserts the STP_PCI# signal to the clock synthesizer within 4 (free running) clocks.
- Observing the CLKRUN# signal asserted externally for 1 (free running) clock, the PCH again starts driving CLKRUN# asserted.

If an internal source requests the clock to be re-started, the PCH re-asserts CLKRUN#, and simultaneously deasserts the STP_PCI# signal. For case when PCH distribute PCI clock, PCH start PCI clocks without the involvement of STP_PCI#.

5.13.6.5 LPC Devices and CLKRUN#

If an LPC device (of any type) needs the 33 MHz PCI clock, such as for LPC DMA or LPC serial interrupt, then it can assert CLKRUN#. Note that LPC devices running DMA or bus master cycles will not need to assert CLKRUN#, since the PCH asserts it on their behalf.

The LDRQ# inputs are ignored by the PCH when the PCI clock is stopped to the LPC devices in order to avoid misinterpreting the request. The PCH assumes that only one more rising PCI clock edge occurs at the LPC device after the assertion of STP_PCI#. Upon deassertion of STP_PCI#, the PCH assumes that the LPC device receives its first clock rising edge corresponding to the PCH's second PCI clock rising edge after the deassertion.

5.13.7 Sleep States

5.13.7.1 Sleep State Overview

The PCH directly supports different sleep states (S1–S5), which are entered by methods such as setting the SLP_EN bit or due to a Power Button press. The entry to the Sleep states is based on several assumptions:

- The G3 state cannot be entered using any software mechanism. The G3 state indicates a complete loss of power.



5.13.7.2 Initiating Sleep State

Sleep states (S1–S5) are initiated by:

- Masking interrupts, turning off all bus master enable bits, setting the desired type in the SLP_TYP field, and then setting the SLP_EN bit. The hardware then attempts to gracefully put the system into the corresponding Sleep state.
- Pressing the PWRBTN# Signal for more than 4 seconds to cause a Power Button Override event. In this case the transition to the S5 state is less graceful, since there are no dependencies on DMI messages from the processor or on clocks other than the RTC clock.
- Assertion of the THRMTRIP# signal will cause a transition to the S5 state. This can occur when system is in S0 or S1 state.
- Shutdown by integrated manageability functions (ASF/Intel AMT)
- Internal watchdog timer time-out events

Table 5-26. Sleep Types

Sleep Type	Comment
S1	System lowers the processor's power consumption. No snooping is possible in this state.
S3	The PCH asserts SLP_S3#. The SLP_S3# signal controls the power to non-critical circuits. Power is only retained to devices needed to wake from this sleeping state, as well as to the memory.
S4	The PCH asserts SLP_S3# and SLP_S4#. The SLP_S4# signal shuts off the power to the memory subsystem. Only devices needed to wake from this state should be powered.
S5	The PCH asserts SLP_S3#, SLP_S4# and SLP_S5#.

5.13.7.3 Exiting Sleep States

Sleep states (S1–S5) are exited based on Wake events. The Wake events forces the system to a full on state (S0), although some non-critical subsystems might still be shut off and have to be brought back manually. For example, the hard disk may be shut off during a sleep state and have to be enabled using a GPIO pin before it can be used.

Upon exit from the PCH-controlled Sleep states, the WAK_STS bit is set. The possible causes of Wake Events (and their restrictions) are shown in [Table 5-27](#).

Note: (Mobile Only) If the BATLOW# signal is asserted, the PCH does not attempt to wake from an S1–S5 state, even if the power button is pressed. This prevents the system from waking when the battery power is insufficient to wake the system. Wake events that occur while BATLOW# is asserted are latched by the PCH, and the system wakes after BATLOW# is deasserted.

Table 5-27. Causes of Wake Events (Sheet 1 of 2)

Cause	How Enabled	Wake from S1, Sx	Wake from Deep S4/S5	Wake from S1, Sx After Power Loss (Note 1)	Wake from "Reset" Types (Note 2)
RTC Alarm	Set RTC_EN bit in PM1_EN register.	Y	Y	Y	
Power Button	Always enabled as Wake event.	Y	Y	Y	Y
GPI[15:0]	GPE0_EN register NOTE: GPIs that are in the core well are not capable of waking the system from sleep states when the core well is not powered.	Y			
GPIO27	Set GP27_EN in GPE0_EN Register.	Y	Y	Y	Y
LAN	Will use PME#. Wake enable set with LAN logic.	Y		Y	
RI#	Set RI_EN bit in GPE0_EN register.	Y		Y	
Intel® High Definition Audio	Event sets PME_B0_STS bit; PM_B0_EN must be enabled. Can not wake from S5 state if it was entered due to power failure or power button override.	Y		Y	
Primary PME#	PME_B0_EN bit in GPE0_EN register.	Y		Y	
Secondary PME#	Set PME_EN bit in GPE0_EN register.	Y		Y	
PCI_EXP_WAKE#	PCI_EXP_WAKE bit. (Note 3)	Y		Y	
SATA	Set PME_EN bit in GPE0_EN register. (Note 4)	S1		S1	
PCI_EXP PME Message	Must use the PCI Express* WAKE# pin rather than messages for wake from S3, S4, or S5.	S1		S1	
SMBALERT#	Always enabled as Wake event.	Y		Y	Y
SMBus Slave Wake Message (01h)	Wake/SMI# command always enabled as a Wake event. NOTE: SMBus Slave Message can wake the system from S1–S5, as well as from S5 due to Power Button Override.	Y		Y	Y

**Table 5-27. Causes of Wake Events (Sheet 2 of 2)**

Cause	How Enabled	Wake from S1, Sx	Wake from Deep S4/S5	Wake from S1, Sx After Power Loss (Note 1)	Wake from "Reset" Types (Note 2)
SMBus Host Notify message received	HOST_NOTIFY_WKEN bit SMBus Slave Command register. Reported in the SMB_WAK_STS bit in the GPEO_STS register.	Y		Y	Y
Intel® ME Non-Maskable Wake	Always enabled as a wake event.	Y		Y	Y
Integrated WOL Enable Override	WOL Enable Override bit (in Configuration Space).	Y		Y	Y

NOTES:

1. This column represents what the PCH would honor as wake events but there may be enabling dependencies on the device side which are not enabled after a power loss.
2. Reset Types include: Power Button override, Intel ME initiated power button override, Intel ME initiated host partition reset with power down, Intel ME Watchdog Timer, SMBus unconditional power down, processor thermal trip, PCH catastrophic temperature event.
3. When the WAKE# pin is active and the PCI Express device is enabled to wake the system, the PCH will wake the platform.
4. SATA can only trigger a wake event in S1, but if PME is asserted prior to S3/S4/S5 entry and software does not clear the PME_B0_STS, a wake event would still result.

It is important to understand that the various GPIs have different levels of functionality when used as wake events. The GPIs that reside in the core power well can only generate wake events from sleep states where the core well is powered. Also, only certain GPIs are "ACPI Compliant," meaning that their Status and Enable bits reside in ACPI I/O space. [Table 5-28](#) summarizes the use of GPIs as wake events.

Table 5-28. GPI Wake Events

GPI	Power Well	Wake From	Notes
GPI[7:0]	Core	S1	ACPI Compliant
GPI[15:8]	Suspend	S1-S5	ACPI Compliant

The latency to exit the various Sleep states varies greatly and is heavily dependent on power supply design, so much so that the exit latencies due to the PCH are insignificant.

5.13.7.4 PCI Express* WAKE# Signal and PME Event Message

PCI Express ports can wake the platform from any sleep state (S1, S3, S4, or S5) using the WAKE# pin. WAKE# is treated as a wake event, but does not cause any bits to go active in the GPE_STS register.

PCI Express ports and the processor (using DMI) have the ability to cause PME using messages. When a PME message is received, the PCH will set the PCI_EXP_STS bit.

5.13.7.5 Sx-G3-Sx, Handling Power Failures

Depending on when the power failure occurs and how the system is designed, different transitions could occur due to a power failure.

The AFTERG3_EN bit provides the ability to program whether or not the system should boot once power returns after a power loss event. If the policy is to not boot, the system remains in an S5 state (unless previously in S4). There are only three possible events that will wake the system after a power failure.

1. **PWRBTN#:** PWRBTN# is always enabled as a wake event. When RSMRST# is low (G3 state), the PWRBTN_STS bit is reset. When the PCH exits G3 after power returns (RSMRST# goes high), the PWRBTN# signal is already high (because V_{CC}-standby goes high before RSMRST# goes high) and the PWRBTN_STS bit is 0.
2. **RI#:** RI# does not have an internal pull-up. Therefore, if this signal is enabled as a wake event, it is important to keep this signal powered during the power loss event. If this signal goes low (active), when power returns the RI_STS bit is set and the system interprets that as a wake event.
3. **RTC Alarm:** The RTC_EN bit is in the RTC well and is preserved after a power loss. Like PWRBTN_STS the RTC_STS bit is cleared when RSMRST# goes low.

The PCH monitors both PCH PWROK and RSMRST# to detect for power failures. If PCH PWROK goes low, the PWROK_FLR bit is set. If RSMRST# goes low, PWR_FLR is set.

Note: Although PME_EN is in the RTC well, this signal cannot wake the system after a power loss. PME_EN is cleared by RTCRST#, and PME_STS is cleared by RSMRST#.

Table 5-29. Transitions Due to Power Failure

State at Power Failure	AFTERG3_EN bit	Transition When Power Returns
S0, S1, S3	1 0	S5 S0
S4	1 0	S4 S0
S5	1 0	S5 S0
Deep S4/S5	1 0	Deep S4/S5 ¹ S0

NOTE:

1. Entry state to Deep S4/S5 is preserved through G3 allowing resume from Deep S4/S5 to take appropriate path (that is, return to S4 or S5).



5.13.7.6 Deep S4/S5

To minimize power consumption while in S4/S5, the PCH supports a lower power, lower featured version of these power states known as Deep S4/S5. In the Deep S4/S5 state, the Suspend wells are powered off, while the Deep S4/S5 Well (DSW) remains powered. A limited set of wake events are supported by the logic located in the DSW.

The Deep S4/S5 capability and the SUSWRDNACK pin functionality are mutually exclusive.

5.13.7.6.1 Entry Into Deep S4/S5

A combination of conditions is required for entry into Deep S4/S5.

All of the following must be met:

- Intel ME in Mof
- AND either a or b as defined below:
 - a. ((DPS4_EN_AC AND S4) OR (DPS5_EN_AC AND S5)) (desktop only)
 - b. ((AC_PRESENT = 0) AND ((DPS4_EN_DC AND S4) OR (DPS5_EN_DC AND S5)))

Table 5-30. Supported Deep S4/S5 Policy Configurations

Configuration	DPS4_EN_DC	DPS4_EN_AC	DPS5_EN_DC	DPS5_EN_AC
1: Enabled in S5 when on Battery (ACPRESENT = 0)	0	0	1	0
2: Enabled in S5 (ACPRESENT not considered) (desktop only)	0	0	1	1
3: Enabled in S4 and S5 when on Battery (ACPRESENT = 0)	1	0	1	0
4: Enabled in S4 and S5 (ACPRESENT not considered) (desktop only)	1	1	1	1
5: Deep S4 / S5 disabled	0	0	0	0

The PCH also performs a SUSWARN#/SUSACK# handshake to ensure the platform is ready to enter Deep S4/S5. The PCH asserts SUSWARN# as notification that it is about to enter Deep S4/S5. Before the PCH proceeds and asserts SLP_SUS#, the PCH waits for SUSACK# to assert.

5.13.7.6.2 Exit from Deep S4/S5

While in Deep S4/S5, the PCH monitors and responds to a limited set of wake events (RTC Alarm, Power Button, and GPIO27). Upon sensing an enabled Deep S4/S5 wake event, the PCH brings up the Suspend well by deasserting SLP_SUS#.

Table 5-31. Deep S4/S5 Wake Events

Event	Enable
RTC Alarm	RTC_DS_WAKE_DIS (RCBA+3318h:Bit 21)
Power Button	Always enabled
GPIO27	GPIO27_EN (PMBASE+28h:Bit 35)

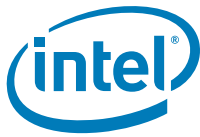

Note that ACPRESENT has some behaviors that are different from the other Deep S4/S5 wake events. If the Intel ME has enabled ACPRESENT as a wake event then it behaves just like any other Intel ME Deep S4/S5 wake event. However, even if ACPRESENT wakes are not enabled, if the Host policies indicate that Deep S4/S5 is only supported when on battery, then ACPRESENT going high will cause the PCH to exit Deep S4/S5. In this case, the Suspend wells gets powered up and the platform remains in S4/MOFF or S5/MOFF. If ACPRESENT subsequently drops (before any Host or Intel ME wake events are detected), the PCH will re-enter Deep S4/S5.

5.13.8 Event Input Signals and Their Usage

The PCH has various input signals that trigger specific events. This section describes those signals and how they should be used.

5.13.8.1 PWRBTN# (Power Button)

The PCH PWRBTN# signal operates as a “Fixed Power Button” as described in the *Advanced Configuration and Power Interface, Version 2.0b*. PWRBTN# signal has a 16 ms de-bounce on the input. The state transition descriptions are included in [Table 5-32](#). Note that the transitions start as soon as the PWRBTN# is pressed (but after the debounce logic), and does not depend on when the Power Button is released.

Note: During the time that the SLP_S4# signal is stretched for the minimum assertion width (if enabled), the Power Button is not a wake event. Refer to the following Power Button Override Function section for further details.

Table 5-32. Transitions Due to Power Button

Present State	Event	Transition/Action	Comment
S0/Cx	PWRBTN# goes low	SMI or SCI generated (depending on SCI_EN, PWRBTN_EN and GLB_SMI_EN)	Software typically initiates a Sleep state
S1–S5	PWRBTN# goes low	Wake Event. Transitions to S0 state	Standard wakeup
G3	PWRBTN# pressed	None	No effect since no power Not latched nor detected
S0–S4	PWRBTN# held low for at least 4 consecutive seconds	Unconditional transition to S5 state	No dependence on processor (DMI Messages) or any other subsystem

Power Button Override Function

If PWRBTN# is observed active for at least four consecutive seconds, the state machine should unconditionally transition to the G2/S5 state, regardless of present state (S0–S4), even if the PCH PWROK is not active. In this case, the transition to the G2/S5 state should not depend on any particular response from the processor (such as, a DMI Messages), nor any similar dependency from any other subsystem.

The PWRBTN# status is readable to check if the button is currently being pressed or has been released. The status is taken after the de-bounce, and is readable using the PWRBTN_LVL bit.

Note: The 4-second PWRBTN# assertion should only be used if a system lock-up has occurred. The 4-second timer starts counting when the PCH is in a S0 state. If the PWRBTN# signal is asserted and held active when the system is in a suspend state



(S1–S5), the assertion causes a wake event. Once the system has resumed to the S0 state, the 4-second timer starts.

Note: During the time that the SLP_S4# signal is stretched for the minimum assertion width (if enabled by D31:F0:A4h Bit 3), the Power Button is not a wake event. As a result, it is conceivable that the user will press and continue to hold the Power Button waiting for the system to awake. Since a 4-second press of the Power Button is already defined as an Unconditional Power down, the power button timer will be forced to inactive while the power-cycle timer is in progress. Once the power-cycle timer has expired, the Power Button awakes the system. Once the minimum SLP_S4# power cycle expires, the Power Button must be pressed for another 4 to 5 seconds to create the Override condition to S5.

Sleep Button

The *Advanced Configuration and Power Interface, Version 2.0b* defines an optional Sleep button. It differs from the power button in that it only is a request to go from S0 to S1–S4 (not S5). Also, in an S5 state, the Power Button can wake the system, but the Sleep Button cannot.

Although the PCH does not include a specific signal designated as a Sleep Button, one of the GPIO signals can be used to create a “Control Method” Sleep Button. See the *Advanced Configuration and Power Interface, Version 2.0b* for implementation details.

5.13.8.2 RI# (Ring Indicator)

The Ring Indicator can cause a wake event (if enabled) from the S1–S5 states. [Table 5-33](#) shows when the wake event is generated or ignored in different states. If in the G0/S0/Cx states, the PCH generates an interrupt based on RI# active, and the interrupt will be set up as a Break event.

Table 5-33. Transitions Due to RI# Signal

Present State	Event	RI_EN	Event
S0	RI# Active	X	Ignored
S1–S5	RI# Active	0	Ignored
		1	Wake Event

Note: Filtering/Debounce on RI# will not be done in PCH. Can be in modem or external.

5.13.8.3 PME# (PCI Power Management Event)

The PME# signal comes from a PCI device to request that the system be restarted. The PME# signal can generate an SMI#, SCI, or optionally a Wake event. The event occurs when the PME# signal goes from high to low. No event is caused when it goes from low to high.

There is also an internal PME_B0 bit. This is separate from the external PME# signal and can cause the same effect.

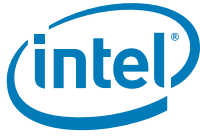

5.13.8.4 SYS_RESET# Signal

When the SYS_RESET# pin is detected as active after the 16 ms debounce logic, the PCH attempts to perform a “graceful” reset, by waiting up to 25 ms for the SMBus to go idle. If the SMBus is idle when the pin is detected active, the reset occurs immediately; otherwise, the counter starts. If at any point during the count the SMBus goes idle the reset occurs. If, however, the counter expires and the SMBus is still active, a reset is forced upon the system even though activity is still occurring.

Once the reset is asserted, it remains asserted for 5 to 6 ms regardless of whether the SYS_RESET# input remains asserted or not. It cannot occur again until SYS_RESET# has been detected inactive after the debounce logic, and the system is back to a full S0 state with PLTRST# inactive. Note that if bit 3 of the CF9h I/O register is set then SYS_RESET# will result in a full power cycle reset.

5.13.8.5 THRMTRIP# Signal

If THRMTRIP# goes active, the processor is indicating an overheat condition, and the PCH immediately transitions to an S5 state, driving SLP_S3#, SLP_S4#, SLP_S5# low, and setting the CTS bit. The transition looks like a power button override.

When a THRMTRIP# event occurs, the PCH will power down immediately without following the normal S0 -> S5 path. The PCH will immediately drive SLP_S3#, SLP_S4#, and SLP_S5# low after sampling THRMTRIP# active.

If the processor is running extremely hot and is heating up, it is possible (although very unlikely) that components around it, such as the PCH, are no longer executing cycles properly. Therefore, if THRMTRIP# goes active, and the PCH is relying on state machine logic to perform the power down, the state machine may not be working, and the system will not power down.

The PCH provides filtering for short low glitches on the THRMTRIP# signal in order to prevent erroneous system shut downs from noise. Glitches shorter than 25nsec are ignored.

During boot, THRMTRIP# is ignored until SLP_S3#, PWROK, and PLTRST# are all '1'. During entry into a powered-down state (due to S3, S4, S5 entry, power cycle reset, etc.) THRMTRIP# is ignored until either SLP_S3# = 0, or PCH PWROK = 0, or SYS_PWROK = 0.

Note:

A thermal trip event will:

- Clear the PWRBTN_STS bit
- Clear all the GPE0_EN register bits
- Clear the SMB_WAK_STS bit only if SMB_SAK_STS was set due to SMBus slave receiving message and not set due to SMBAlert



5.13.9 ALT Access Mode

Before entering a low power state, several registers from powered down parts may need to be saved. In the majority of cases, this is not an issue, as registers have read and write paths. However, several of the ISA compatible registers are either read only or write only. To get data out of write-only registers, and to restore data into read-only registers, the PCH implements an ALT access mode.

If the ALT access mode is entered and exited after reading the registers of the PCH timer (8254), the timer starts counting faster (13.5 ms). The following steps listed below can cause problems:

1. BIOS enters ALT access mode for reading the PCH timer related registers.
2. BIOS exits ALT access mode.
3. BIOS continues through the execution of other needed steps and passes control to the operating system.

After getting control in step #3, if the operating system does not reprogram the system timer again, the timer ticks may be happening faster than expected. For example Microsoft MS-DOS* and its associated software assume that the system timer is running at 54.6 ms and as a result the time-outs in the software may be happening faster than expected.

Operating systems (such as Microsoft Windows* 98 and Windows* 2000) reprogram the system timer and therefore do not encounter this problem.

For other operating systems (such as Microsoft MS-DOS*) the BIOS should restore the timer back to 54.6 ms before passing control to the operating system. If the BIOS is entering ALT access mode before entering the suspend state it is not necessary to restore the timer contents after the exit from ALT access mode.

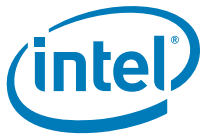

5.13.9.1 Write Only Registers with Read Paths in ALT Access Mode

The registers described in Table 5-34 have read paths in ALT access mode. The access number field in the table indicates which register will be returned per access to that port.

Table 5-34. Write Only Registers with Read Paths in ALT Access Mode (Sheet 1 of 2)

Restore Data				Restore Data			
I/O Addr	# of Rds	Access	Data	I/O Addr	# of Rds	Access	Data
00h	2	1	DMA Chan 0 base address low byte	40h	7	1	Timer Counter 0 status, bits [5:0]
		2	DMA Chan 0 base address high byte			2	Timer Counter 0 base count low byte
01h	2	1	DMA Chan 0 base count low byte			3	Timer Counter 0 base count high byte
		2	DMA Chan 0 base count high byte			4	Timer Counter 1 base count low byte
02h	2	1	DMA Chan 1 base address low byte			5	Timer Counter 1 base count high byte
		2	DMA Chan 1 base address high byte			6	Timer Counter 2 base count low byte
03h	2	1	DMA Chan 1 base count low byte			7	Timer Counter 2 base count high byte
		2	DMA Chan 1 base count high byte	41h	1	Timer Counter 1 status, bits [5:0]	
04h	2	1	DMA Chan 2 base address low byte	42h	1	Timer Counter 2 status, bits [5:0]	
		2	DMA Chan 2 base address high byte	70h	1	Bit 7 = NMI Enable, Bits [6:0] = RTC Address	
05h	2	1	DMA Chan 2 base count low byte	C4h	2	1	DMA Chan 5 base address low byte
		2	DMA Chan 2 base count high byte			2	DMA Chan 5 base address high byte
06h	2	1	DMA Chan 3 base address low byte	C6h	2	1	DMA Chan 5 base count low byte
		2	DMA Chan 3 base address high byte			2	DMA Chan 5 base count high byte
07h	2	1	DMA Chan 3 base count low byte	C8h	2	1	DMA Chan 6 base address low byte
		2	DMA Chan 3 base count high byte			2	DMA Chan 6 base address high byte



Table 5-34. Write Only Registers with Read Paths in ALT Access Mode (Sheet 2 of 2)

Restore Data				Restore Data				
I/O Addr	# of Rds	Access	Data	I/O Addr	# of Rds	Access	Data	
08h	6	1	DMA Chan 0–3 Command ²	CAh	2	1	DMA Chan 6 base count low byte	
		2	DMA Chan 0–3 Request			2	DMA Chan 6 base count high byte	
		3	DMA Chan 0 Mode: Bits(1:0) = 00	CCh	2	1	DMA Chan 7 base address low byte	
		4	DMA Chan 1 Mode: Bits(1:0) = 01			2	DMA Chan 7 base address high byte	
		5	DMA Chan 2 Mode: Bits(1:0) = 10	CEh	2	1	DMA Chan 7 base count low byte	
		6	DMA Chan 3 Mode: Bits(1:0) = 11.			2	DMA Chan 7 base count high byte	
20h	12	1	PIC ICW2 of Master controller	D0h	6	1	DMA Chan 4–7 Command ²	
		2	PIC ICW3 of Master controller			2	DMA Chan 4–7 Request	
		3	PIC ICW4 of Master controller			3	DMA Chan 4 Mode: Bits(1:0) = 00	
		4	PIC OCW1 of Master controller ¹			4	DMA Chan 5 Mode: Bits(1:0) = 01	
		5	PIC OCW2 of Master controller			5	DMA Chan 6 Mode: Bits(1:0) = 10	
		6	PIC OCW3 of Master controller			6	DMA Chan 7 Mode: Bits(1:0) = 11.	
		7	PIC ICW2 of Slave controller					
		8	PIC ICW3 of Slave controller					
		9	PIC ICW4 of Slave controller					
		10	PIC OCW1 of Slave controller ¹					
		11	PIC OCW2 of Slave controller					
		12	PIC OCW3 of Slave controller					

NOTES:

1. The OCW1 register must be read before entering ALT access mode.
2. Bits 5, 3, 1, and 0 return 0.



5.13.9.2 PIC Reserved Bits

Many bits within the PIC are reserved, and must have certain values written in order for the PIC to operate properly. Therefore, there is no need to return these values in ALT access mode. When reading PIC registers from 20h and A0h, the reserved bits shall return the values listed in [Table 5-35](#).

Table 5-35. PIC Reserved Bits Return Values

PIC Reserved Bits	Value Returned
ICW2(2:0)	000
ICW4(7:5)	000
ICW4(3:2)	00
ICW4(0)	0
OCW2(4:3)	00
OCW3(7)	0
OCW3(5)	Reflects bit 6
OCW3(4:3)	01

5.13.9.3 Read Only Registers with Write Paths in ALT Access Mode

The registers described in [Table 5-36](#) have write paths to them in ALT access mode. Software restores these values after returning from a powered down state. These registers must be handled special by software. When in normal mode, writing to the base address/count register also writes to the current address/count register. Therefore, the base address/count must be written first, then the part is put into ALT access mode and the current address/count register is written.

Table 5-36. Register Write Accesses in ALT Access Mode

I/O Address	Register Write Value
08h	DMA Status Register for Channels 0–3
D0h	DMA Status Register for Channels 4–7



5.13.10 System Power Supplies, Planes, and Signals

5.13.10.1 Power Plane Control with SLP_S3#, SLP_S4#, SLP_S5#, SLP_A# and SLP_LAN#

The SLP_S3# output signal can be used to cut power to the system core supply, since it only goes active for the Suspend-to-RAM state (typically mapped to ACPI S3). Power must be maintained to the PCH suspend well, and to any other circuits that need to generate Wake signals from the Suspend-to-RAM state. During S3 (Suspend-to-RAM) all signals attached to powered down plans will be tri-stated or driven low, unless they are pulled using a pull-up resistor.

Cutting power to the core may be done using the power supply, or by external FETs on the motherboard.

The SLP_S4# or SLP_S5# output signal can be used to cut power to the system core supply, as well as power to the system memory, since the context of the system is saved on the disk. Cutting power to the memory may be done using the power supply, or by external FETs on the motherboard.

The SLP_S4# output signal is used to remove power to additional subsystems that are powered during SLP_S3#.

SLP_S5# output signal can be used to cut power to the system core supply, as well as power to the system memory, since the context of the system is saved on the disk. Cutting power to the memory may be done using the power supply, or by external FETs on the motherboard.

SLP_A# output signal can be used to cut power to the Intel Management Engine and SPI flash on a platform that supports the M3 state (for example, certain power policies in Intel AMT).

SLP_LAN# output signal can be used to cut power to the external Intel 82579 GbE PHY device.

5.13.10.2 SLP_S4# and Suspend-To-RAM Sequencing

The system memory suspend voltage regulator is controlled by the Glue logic. The SLP_S4# signal should be used to remove power to system memory rather than the SLP_S5# signal. The SLP_S4# logic in the PCH provides a mechanism to fully cycle the power to the DRAM and/or detect if the power is not cycled for a minimum time.

Note: To use the minimum DRAM power-down feature that is enabled by the SLP_S4# Assertion Stretch Enable bit (D31:F0:A4h Bit 3), the DRAM power must be controlled by the SLP_S4# signal.

5.13.10.3 PWROK Signal

When asserted, PWROK is an indication to the PCH that its core well power rails are powered and stable. PWROK can be driven asynchronously. When PCH PWROK is low, the PCH asynchronously asserts PLTRST#. PWROK must not glitch, even if RSMRST# is low.

It is required that the power associated with PCI/PCIe have been valid for 99 ms prior to PWROK assertion in order to comply with the 100 ms PCI 2.3 / PCIe 2.0 specification on PLTRST# deassertion.

Note: SYS_RESET# is recommended for implementing the system reset button. This saves external logic that is needed if the PWROK input is used. Additionally, it allows for

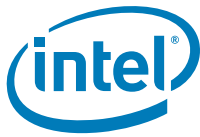

better handling of the SMBus and processor resets and avoids improperly reporting power failures.

5.13.10.4 BATLOW# (Battery Low) (Mobile Only)

The BATLOW# input can inhibit waking from S3, S4, and S5 states if there is not sufficient power. It also causes an SMI if the system is already in an S0 state.

5.13.10.5 SLP_LAN# Pin Behavior

Table 5-37 summarizes SLP_LAN# pin behavior.

Table 5-37. SLP_LAN# Pin Behavior

Pin Functionality (Determined by soft strap)	SLP_LAN Default Value Bit	GPIO29 Input / Output (Determined by GP_IO_SEL bit)	Pin Value In S0 or M3	Value in S3-S5/Moff
SLP_LAN#	0 (Default)	In (Default)	1	0
		Out	1	Depends on GPIO29 output data value
	1	In (Default)	1	1
		Out	1	Depends on GPIO29 output data value
GPIO29	0 (Default)	In	Z (tri-state)	0
	1	In	Z (tri-state)	1
	N/A	Out	Depends on GPIO29 output data value	Depends on GPIO29 output data value

5.13.10.6 RTCRST# and SRTCST#

The basic behavior of the SRTCST# and RTCRST# signals can be summarized by the following:

1. RTC coin cell removal: both SRTCST# and RTCRST# assert and reset logic
2. Clear CMOS board capability: only RTCRST# asserts

It is imperative that SRTCST# is only asserted when RTCRST# is also asserted. A jumper on the SRTCST# signal should not be implemented.

5.13.11 Clock Generators

The clock generator is expected to provide the frequencies shown in [Table 4-1](#).



5.13.12 Legacy Power Management Theory of Operation

Instead of relying on ACPI software, legacy power management uses BIOS and various hardware mechanisms. The scheme relies on the concept of detecting when individual subsystems are idle, detecting when the whole system is idle, and detecting when accesses are attempted to idle subsystems.

However, the operating system is assumed to be at least APM enabled. Without APM calls, there is no quick way to know when the system is idle between keystrokes. The PCH does not support burst modes.

5.13.12.1 APM Power Management (Desktop Only)

The PCH has a timer that, when enabled by the 1MIN_EN bit in the SMI Control and Enable register, generates an SMI once per minute. The SMI handler can check for system activity by reading the DEVTRAP_STS register. If none of the system bits are set, the SMI handler can increment a software counter. When the counter reaches a sufficient number of consecutive minutes with no activity, the SMI handler can then put the system into a lower power state.

If there is activity, various bits in the DEVTRAP_STS register will be set. Software clears the bits by writing a 1 to the bit position.

The DEVTRAP_STS register allows for monitoring various internal devices, or Super I/O devices (SP, PP, FDC) on LPC or PCI, keyboard controller accesses, or audio functions on LPC or PCI. Other PCI activity can be monitored by checking the PCI interrupts.

5.13.12.2 Mobile APM Power Management (Mobile Only)

In mobile systems, there are additional requirements associated with device power management. To handle this, the PCH has specific SMI traps available. The following algorithm is used:

1. The periodic SMI timer checks if a device is idle for the require time. If so, it puts the device into a low-power state and sets the associated SMI trap.
2. When software (not the SMI handler) attempts to access the device, a trap occurs (the cycle doesn't really go to the device and an SMI is generated).
3. The SMI handler turns on the device and turns off the trap.
4. The SMI handler exits with an I/O restart. This allows the original software to continue.

5.13.13 Reset Behavior

When a reset is triggered, the PCH will send a warning message to the processor to allow the processor to attempt to complete any outstanding memory cycles and put memory into a safe state before the platform is reset. When the processor is ready, it will send an acknowledge message to the PCH. Once the message is received the PCH asserts PLTRST#.

The PCH does not require an acknowledge message from the processor to trigger PLTRST#. A global reset will occur after 4 seconds if an acknowledge from the processor is not received.

When the PCH causes a reset by asserting PLTRST# its output signals will go to their reset states as defined in [Chapter 3](#).

A reset in which the host platform is reset and PLTRST# is asserted is called a Host Reset or Host Partition Reset. Depending on the trigger a host reset may also result in power cycling see [Table 5-38](#) for details. If a host reset is triggered and the PCH times out before receiving an acknowledge message from the processor a Global Reset with power cycle will occur.

A reset in which the host and Intel ME partitions of the platform are reset is called a Global Reset. During a Global Reset, all PCH functionality is reset except RTC Power Well backed information and Suspend well status, configuration, and functional logic for controlling and reporting the reset. Intel ME and Host power back up after the power cycle period.

Straight to S5 is another reset type where all power wells that are controlled by the SLP_S3#, SLP_S4#, and SLP_A# pins, as well as SLP_S5# and SLP_LAN# (if pins are not configured as GPIOs), are turned off. All PCH functionality is reset except RTC Power Well backed information and Suspend well status, configuration, and functional logic for controlling and reporting the reset. The host stays there until a valid wake event occurs.

[Table 5-38](#) shows the various reset triggers.

Table 5-38. Causes of Host and Global Resets (Sheet 1 of 2)

Trigger	Host Reset without Power Cycle ¹	Host Reset with Power Cycle ²	Global Reset with Power Cycle ³	Straight to S5 (Host Stays there)
Write of 0Eh to CF9h (RST_CNT Register)	No	Yes	No (Note 4)	
Write of 06h to CF9h (RST_CNT Register)	Yes	No	No (Note 4)	
SYS_RESET# Asserted and CF9h (RST_CNT Register) Bit 3 = 0	Yes	No	No (Note 4)	
SYS_RESET# Asserted and CF9h (RST_CNT Register) Bit 3 = 1	No	Yes	No (Note 4)	
SMBus Slave Message received for Reset with Power Cycle	No	Yes	No (Note 4)	
SMBus Slave Message received for Reset without Power Cycle	Yes	No	No (Note 4)	
SMBus Slave Message received for unconditional Power Down	No	No	No	Yes
TCO Watchdog Timer reaches zero two times	Yes	No	No (Note 4)	
Power Failure: PWROK signal goes inactive in S0/S1 or DPWROK drops	No	No	Yes	
SYS_PWROK Failure: SYS_PWROK signal goes inactive in S0/S1	No	No	Yes	
Processor Thermal Trip (THRMTRIP#) causes transition to S5 and reset asserts	No	No	No	Yes
PCH internal thermal sensors signals a catastrophic temperature condition	No	No	No	Yes
Power Button 4 second override causes transition to S5 and reset asserts	No	No	No	Yes
Special shutdown cycle from processor causes CF9h-like PLTRST# and CF9h (RST_CNT Register) Bit 3 = 1	No	Yes	No (Note 4)	
Special shutdown cycle from processor causes CF9h-like PLTRST# and CF9h (RST_CNT Register) Bit 3 = 0	Yes	No	No (Note 4)	
Intel® Management Engine Triggered Host Reset without power cycle	Yes	No	No (Note 4)	
Intel Management Engine Triggered Host Reset with power cycle	No	Yes	No (Note 4)	



Table 5-38. Causes of Host and Global Resets (Sheet 2 of 2)

Trigger	Host Reset without Power Cycle ¹	Host Reset with Power Cycle ²	Global Reset with Power Cycle ³	Straight to S5 (Host Stays there)
Intel Management Engine Triggered Power Button Override	No	No	No	Yes
Intel Management Engine Watchdog Timer Time-out	No	No	No	Yes
Intel Management Engine Triggered Global Reset	No	No	Yes	
Intel Management Engine Triggered Host Reset with power down (host stays there)	No	Yes (Note 5)	No (Note 4)	
PLTRST# Entry Time-out	No	No	Yes	
S3/S4/S5 Entry Time-out	No	No	No	Yes
PROCPWRGD Stuck Low	No	No	Yes	
Power Management Watchdog Timer	No	No	No	Yes
Intel Management Engine Hardware Uncorrectable Error	No	No	No	Yes

NOTES:

1. The PCH drops this type of reset request if received while the system is in S3/S4/S5.
2. PCH does not drop this type of reset request if received while system is in a software-entered S3/S4/S5 state. However, the PCH will perform the reset without executing the RESET_WARN protocol in these states.
3. The PCH does not send warning message to processor; reset occurs without delay.
4. Trigger will result in Global Reset with power cycle if the acknowledge message is not received by the PCH.
5. The PCH waits for enabled wake event to complete reset.

5.14 System Management (D31:F0)

The PCH provides various functions to make a system easier to manage and to lower the Total Cost of Ownership (TCO) of the system. Features and functions can be augmented using external A/D converters and GPIO, as well as an external microcontroller.

The following features and functions are supported by the PCH:

- Processor present detection
 - Detects if processor fails to fetch the first instruction after reset
- Various Error detection (such as ECC Errors) indicated by host controller
 - Can generate SMI#, SCI, SERR, NMI, or TCO interrupt
- Intruder Detect input
 - Can generate TCO interrupt or SMI# when the system cover is removed
 - INTRUDER# allowed to go active in any power state, including G3
- Detection of bad BIOS Flash (FWH or Flash on SPI) programming
 - Detects if data on first read is FFh (indicates that BIOS flash is not programmed)
- Ability to hide a PCI device
 - Allows software to hide a PCI device in terms of configuration space through the use of a device hide register (See [Section 10.1.45](#))

Note: Voltage ID from the processor can be read using GPI signals.

5.14.1 Theory of Operation

The System Management functions are designed to allow the system to diagnose failing subsystems. The intent of this logic is that some of the system management functionality can be provided without the aid of an external microcontroller.

5.14.1.1 Detecting a System Lockup

When the processor is reset, it is expected to fetch its first instruction. If the processor fails to fetch the first instruction after reset, the TCO timer times out twice and the PCH asserts PLTRST#.



5.14.1.2 Handling an Intruder

The PCH has an input signal, INTRUDER#, that can be attached to a switch that is activated by the system's case being open. This input has a two RTC clock debounce. If INTRUDER# goes active (after the debouncer), this will set the INTRD_DET bit in the TCO2_STS register. The INTRD_SEL bits in the TCO_CNT register can enable the PCH to cause an SMI# or interrupt. The BIOS or interrupt handler can then cause a transition to the S5 state by writing to the SLP_EN bit.

The software can also directly read the status of the INTRUDER# signal (high or low) by clearing and then reading the INTRD_DET bit. This allows the signal to be used as a GPI if the intruder function is not required.

If the INTRUDER# signal goes inactive some point after the INTRD_DET bit is written as a 1, then the INTRD_DET bit will go to a 0 when INTRUDER# input signal goes inactive. Note that this is slightly different than a classic sticky bit, since most sticky bits would remain active indefinitely when the signal goes active and would immediately go inactive when a 1 is written to the bit.

Note: The INTRD_DET bit resides in the PCH's RTC well, and is set and cleared synchronously with the RTC clock. Thus, when software attempts to clear INTRD_DET (by writing a 1 to the bit location) there may be as much as two RTC clocks (about 65 μ s) delay before the bit is actually cleared. Also, the INTRUDER# signal should be asserted for a minimum of 1 ms to ensure that the INTRD_DET bit will be set.

Note: If the INTRUDER# signal is still active when software attempts to clear the INTRD_DET bit, the bit remains set and the SMI is generated again immediately. The SMI handler can clear the INTRD_SEL bits to avoid further SMIs. However, if the INTRUDER# signal goes inactive and then active again, there will not be further SMIs, since the INTRD_SEL bits would select that no SMI# be generated.

5.14.1.3 Detecting Improper Flash Programming

The PCH can detect the case where the BIOS flash is not programmed. This results in the first instruction fetched to have a value of FFh. If this occurs, the PCH sets the BAD_BIOS bit. The BIOS flash may reside in FWH or flash on the SPI bus.

5.14.1.4 Heartbeat and Event Reporting using SMLink/SMBus

Heartbeat and event reporting using SMLink/SMBus is no longer supported. The Intel AMT logic in PCH can be programmed to generate an interrupt to the Intel Management Engine when an event occurs. The Intel Management Engine will poll the TCO registers to gather appropriate bits to send the event message to the Gigabit Ethernet controller, if Intel Management Engine is programmed to do so.

5.14.2 TCO Modes

5.14.2.1 TCO Legacy/Compatible Mode

In TCO Legacy/Compatible mode, only the host SMBus is utilized. The TCO Slave is connected to the host SMBus internally by default. In this mode, the Intel Management Engine SMBus controllers are not used and should be disabled by soft strap.

Figure 5-5. TCO Legacy/Compatible Mode SMBus Configuration

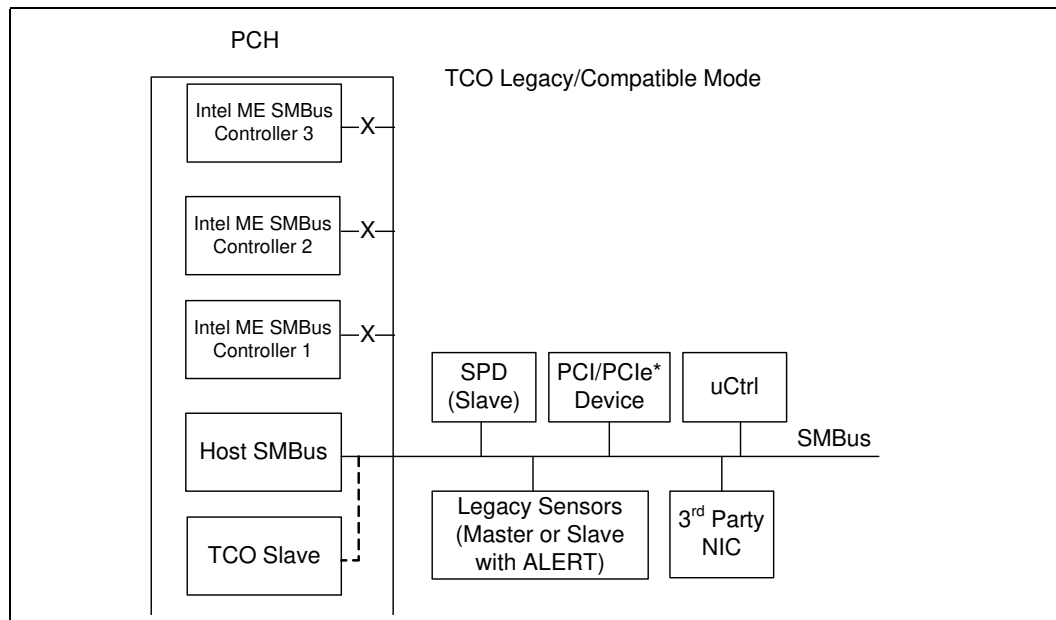

In TCO Legacy/Compatible mode the PCH can function directly with an external LAN controller or equivalent external LAN controller to report messages to a network management console without the aid of the system processor. This is crucial in cases where the processor is malfunctioning or cannot function due to being in a low-power state. Table 5-39 includes a list of events that will report messages to the network management console.

Table 5-39. Event Transitions that Cause Messages

Event	Assertion?	deassertion?	Comments
INTRUDER# pin	yes	no	Must be in "S1 or hung S0" state
THRM# pin	yes	yes	Must be in "S1 or hung S0" state. Note that the THRM# pin is isolated when the core power is off, thus preventing this event in S3-S5.
Watchdog Timer Expired	yes	no (NA)	"S1 or hung S0" state entered
GPIO[11]/SMBALERT# pin	yes	yes	Must be in "S1 or hung S0" state
BATLOW#	yes	yes	Must be in "S1 or hung S0" state
CPU_PWR_FLR	yes	no	"S1 or hung S0" state entered

NOTE: The GPIO11/SMBALERT# pin will trigger an event message (when enabled by the GPIO11_ALERT_DISABLE bit) regardless of whether it is configured as a GPI or not.



5.14.2.2 Advanced TCO Mode

The PCH supports the Advanced TCO mode in which SMLink0 and SMLink1 are used in addition to the host SMBus. See [Figure 5-6](#) for more details. In this mode, the Intel ME SMBus controllers must be enabled by soft strap in the flash descriptor.

SMLink0 is dedicated to integrated LAN use and when an Intel PHY 82579 is connected to SMLink0, a soft strap must be set to indicate that the PHY is connected to SMLink0. The interface will be running at the frequency of 300 kHz - 400 kHz depending on different factors such as board routing or bus loading when the Fast Mode is enabled using a soft strap.

SMLink1 is dedicated to Embedded Controller (EC) or Baseboard Management Controller (BMC) use. In the case where a BMC is connected to SMLink1, the BMC communicates with the Intel Management Engine through the Intel ME SMBus controllers connected to SMLink1. The host and TCO slave communicate with BMC through SMBus.

Figure 5-6. Advanced TCO Mode

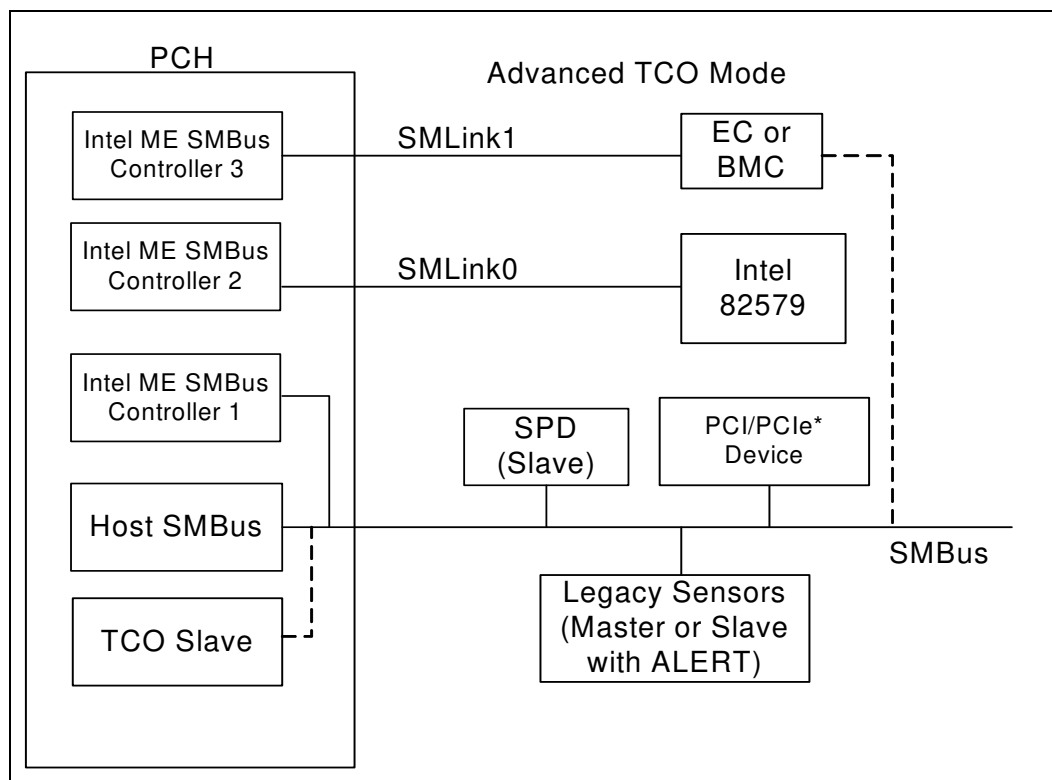

5.15 General Purpose I/O (D31:F0)

The PCH contains up to 70 General Purpose Input/Output (GPIO) signals for Desktop PCH and 75 General Purpose Input/Output (GPIO) for Mobile PCH. Each GPIO can be configured as an input or output signal. The number of inputs and outputs varies depending on the configuration. Following is a brief summary of new GPIO features.

- Capability to mask Suspend well GPIOs from CF9h events (configured using GP_RST_SEL registers)
- Added capability to program GPIO prior to switching to output

5.15.1 Power Wells

Some GPIOs exist in the suspend power plane. Care must be taken to make sure GPIO signals are not driven high into powered-down planes. Some PCH GPIOs may be connected to pins on devices that exist in the core well. If these GPIOs are outputs, there is a danger that a loss of core power (PWROK low) or a Power Button Override event results in the PCH driving a pin to a logic 1 to another device that is powered down.

5.15.2 SMI# SCI and NMI Routing

The routing bits for GPIO[15:0] allow an input to be routed to SMI#, SCI, NMI or neither. Note that a bit can be routed to either an SMI# or an SCI, but not both.

5.15.3 Triggering

GPIO[15:0] have “sticky” bits on the input. Refer to the GPE0_STS register and the ALT_GPI_SMI_STS register. As long as the signal goes active for at least 2 clock cycles, the PCH keeps the sticky status bit active. The active level can be selected in the GP_INV register. This does not apply to GPI_NMI_STS residing in GPIO I/O space.

If the system is in an S0 or an S1 state, the GPI inputs are sampled at 33 MHz, so the signal only needs to be active for about 60 ns to be latched. In the S3–S5 states, the GPI inputs are sampled at 32.768 kHz, and thus must be active for at least 61 microseconds to be latched.

Note: GPIs that are in the core well are not capable of waking the system from sleep states where the core well is not powered.

If the input signal is still active when the latch is cleared, it will again be set. Another edge trigger is not required. This makes these signals “level” triggered inputs.

5.15.4 GPIO Registers Lockdown

The following GPIO registers are locked down when the GPIO Lockdown Enable (GLE) bit is set. The GLE bit resides in D31:F0:GPIO Control (GC) register.

- Offset 00h: GPIO_USE_SEL[31:0]
- Offset 04h: GP_IO_SEL[31:0]
- Offset 0Ch: GP_LVL[31:0]
- Offset 28h: GPI_NMI_EN[15:0]
- Offset 2Ch: GPI_INV[31:0]
- Offset 30h: GPIO_USE_SEL2[63:32]
- Offset 34h: GPI_IO_SEL2[63:32]
- Offset 38h: GP_LVL2[63:32]
- Offset 40h: GPIO_USE_SEL3[95:64]
- Offset 44h: GPI_IO_SEL3[95:64]
- Offset 48h: GP_LVL3[95:64]
- Offset 60h: GP_RST_SEL[31:0]
- Offset 64h: GP_RST_SEL2[63:32]
- Offset 68h: GP_RST_SEL3[95:64]



Once these registers are locked down, they become Read-Only registers and any software writes to these registers will have no effect. To unlock the registers, the GPIO Lockdown Enable (GLE) bit is required to be cleared to '0'. When the GLE bit changes from a '1' to a '0' a System Management Interrupt (SMI#) is generated if enabled. Once the GPIO_UNLOCK_SMI bit is set, it can not be changed until a PLTRST# occurs. This ensures that only BIOS can change the GPIO configuration. If the GLE bit is cleared by unauthorized software, BIOS will set the GLE bit again when the SMI# is triggered and these registers will continue to be locked down.

5.15.5 Serial POST Codes over GPIO

The PCH adds the extended capability allowing system software to serialize POST or other messages on GPIO. This capability negates the requirement for dedicated diagnostic LEDs on the platform. Additionally, based on the newer BTX form factors, the PCI bus as a target for POST codes is increasingly difficult to support as the total number of PCI devices supported are decreasing.

5.15.5.1 Theory of Operation

For the PCH generation POST code serialization logic will be shared with GPIO. These GPIOs will likely be shared with LED control offered by the Super I/O (SIO) component. Figure 5-7 shows a likely configuration.

Figure 5-7. Serial Post over GPIO Reference Circuit

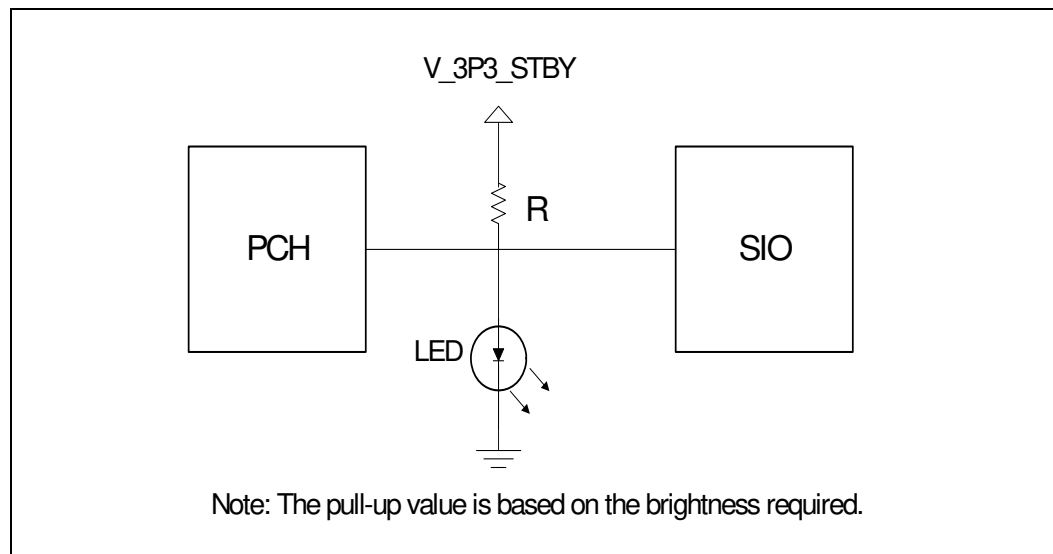

The anticipated usage model is that either the PCH or the SIO can drive a pin low to turn off an LED. In the case of the power LED, the SIO would normally leave its corresponding pin in a high-Z state to allow the LED to turn on. In this state, the PCH can blink the LED by driving its corresponding pin low and subsequently tri-stating the buffer. The I/O buffer should not drive a '1' when configured for this functionality and should be capable of sinking 24 mA of current.

An external optical sensing device can detect the on/off state of the LED. By externally post-processing the information from the optical device, the serial bit stream can be recovered. The hardware will supply a 'sync' byte before the actual data transmission to allow external detection of the transmit frequency. The frequency of transmission should be limited to 1 transition every 1 μ s to ensure the detector can reliably sample

the on/off state of the LED. To allow flexibility in pull-up resistor values for power optimization, the frequency of the transmission is programmable using the DRS field in the GP_GB_CMDSTS register.

The serial bit stream is Manchester encoded. This choice of transmission ensures that a transition will be seen on every clock. The 1 or 0 data is based on the transmission happening during the high or low phase of the clock.

As the clock will be encoded within the data stream, hardware must ensure that the Z-0 and 0-Z transitions are glitch-free. Driving the pin directly from a flop or through glitch-free logic are possible methods to meet the glitch-free requirement.

A simplified hardware/software register interface provides control and status information to track the activity of this block. Software enabling the serial blink capability should implement an algorithm referenced below to send the serialized message on the enabled GPIO.

1. Read the Go/Busy status bit in the GP_GB_CMDSTS register and verify it is cleared. This will ensure that the GPIO is idled and a previously requested message is still not in progress.
2. Write the data to serialize into the GP_GB_DATA register.
3. Write the DLS and DRS values into the GP_GB_CMDSTS register and set the Go bit. This may be accomplished using a single write.

The reference diagram shows the LEDs being powered from the suspend supply. By providing a generic capability that can be used both in the main and the suspend power planes maximum flexibility can be achieved. A key point to make is that the PCH will not unintentionally drive the LED control pin low unless a serialization is in progress. System board connections utilizing this serialization capability are required to use the same power plane controlling the LED as the PCH GPIO pin. Otherwise, the PCH GPIO may float low during the message and prevent the LED from being controlled from the SIO. The hardware will only be serializing messages when the core power well is powered and the processor is operational.

Care should be taken to prevent the PCH from driving an active '1' on a pin sharing the serial LED capability. Since the SIO could be driving the line to 0, having the PCH drive a 1 would create a high current path. A recommendation to avoid this condition involves choosing a GPIO defaulting to an input. The GP_SER_BLINK register should be set first before changing the direction of the pin to an output. This sequence ensures the open-drain capability of the buffer is properly configured before enabling the pin as an output.

5.15.5.2 Serial Message Format

To serialize the data onto the GPIO, an initial state of high-Z is assumed. The SIO is required to have its LED control pin in a high-Z state as well to allow the PCH to blink the LED (refer to the reference diagram).

The three components of the serial message include the sync, data, and idle fields. The sync field is 7 bits of '1' data followed by 1 bit of '0' data. Starting from the high-Z state (LED on) provides external hardware a known initial condition and a known pattern. In case one or more of the leading 1 sync bits are lost, the 1s followed by 0 provide a clear indication of 'end of sync'. This pattern will be used to 'lock' external sampling logic to the encoded clock.

The data field is shifted out with the highest byte first (MSB). Within each byte, the most significant bit is shifted first (MSb).



The idle field is enforced by the hardware and is at least 2 bit times long. The hardware will not clear the Busy and Go bits until this idle time is met. Supporting the idle time in hardware prevents time-based counting in BIOS as the hardware is immediately ready for the next serial code when the Go bit is cleared. Note that the idle state is represented as a high-Z condition on the pin. If the last transmitted bit is a 1, returning to the idle state will result in a final 0-1 transition on the output Manchester data. Two full bit times of idle correspond to a count of 4 time intervals (the width of the time interval is controlled by the DRS field).

The following waveform shows a 1-byte serial write with a data byte of 5Ah. The internal clock and bit position are for reference purposes only. The Manchester D is the resultant data generated and serialized onto the GPIO. Since the buffer is operating in open-drain mode the transitions are from high-Z to 0 and back.

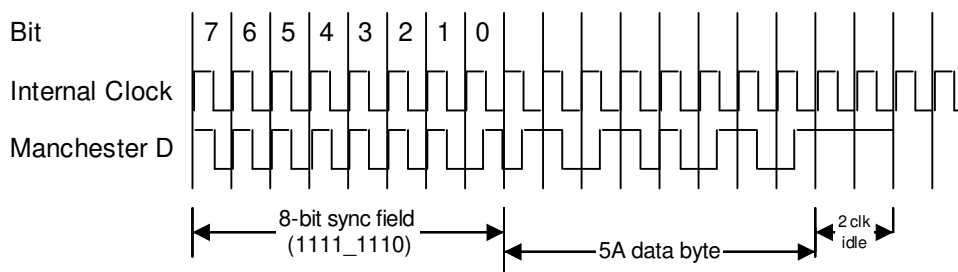

5.16 SATA Host Controller (D31:F2, F5)

The SATA function in the PCH has three modes of operation to support different operating system conditions. In the case of Native IDE enabled operating systems, the PCH uses two controllers to enable all six ports of the bus. The first controller (Device 31: Function 2) supports ports 0 – 3 and the second controller (Device 31: Function 5) supports ports 4 and 5. When using a legacy operating system, only one controller (Device 31: Function 2) is available that supports ports 0 – 3. In AHCI or RAID mode, only one controller (Device 31: Function 2) is utilized enabling all six ports and the second controller (Device 31: Function 5) shall be disabled.

The MAP register, [Section 15.1.25](#), provides the ability to share PCI functions. When sharing is enabled, all decode of I/O is done through the SATA registers. Device 31, Function 1 (IDE controller) is hidden by software writing to the Function Disable Register (D31, F0, Offset F2h, bit 1), and its configuration registers are not used.

The PCH SATA controllers feature six sets of interface signals (ports) that can be independently enabled or disabled (they cannot be tri-stated or driven low). Each interface is supported by an independent DMA controller.

The PCH SATA controllers interact with an attached mass storage device through a register interface that is equivalent to that presented by a traditional IDE host adapter. The host software follows existing standards and conventions when accessing the register interface and follows standard command protocol conventions.

Note: SATA interface transfer rates are independent of UDMA mode settings. SATA interface transfer rates will operate at the bus's maximum speed, regardless of the UDMA mode reported by the SATA device or the system BIOS.

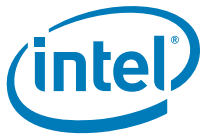

5.16.1 SATA 6 Gb/s Support

The PCH supports SATA 6 Gb/s transfers with all capable SATA devices. SATA 6 Gb/s support is available on PCH Ports 0 and 1 only.

Note: PCH ports 0 and 1 also support SATA 1.5 Gb/s and 3.0 Gb/s device transfers.

5.16.2 SATA Feature Support

Feature	PCH (AHCI/RAID Disabled)	PCH (AHCI/RAID Enabled)
Native Command Queuing (NCQ)	N/A	Supported
Auto Activate for DMA	N/A	Supported
Hot Plug Support	N/A	Supported
Asynchronous Signal Recovery	N/A	Supported
3 Gb/s Transfer Rate	Supported	Supported
ATAPI Asynchronous Notification	N/A	Supported
Host & Link Initiated Power Management	N/A	Supported
Staggered Spin-Up	Supported	Supported
Command Completion Coalescing	N/A	N/A
External SATA	N/A	Supported

Feature	Description
Native Command Queuing (NCQ)	Allows the device to reorder commands for more efficient data transfers
Auto Activate for DMA	Collapses a DMA Setup then DMA Activate sequence into a DMA Setup only
Hot Plug Support	Allows for device detection without power being applied and ability to connect and disconnect devices without prior notification to the system
Asynchronous Signal Recovery	Provides a recovery from a loss of signal or establishing communication after hot plug
6 Gb/s Transfer Rate	Capable of data transfers up to 6 Gb/s
ATAPI Asynchronous Notification	A mechanism for a device to send a notification to the host that the device requires attention
Host & Link Initiated Power Management	Capability for the host controller or device to request Partial and Slumber interface power states
Staggered Spin-Up	Enables the host the ability to spin up hard drives sequentially to prevent power load problems on boot
Command Completion Coalescing	Reduces interrupt and completion overhead by allowing a specified number of commands to complete and then generating an interrupt to process the commands
External SATA	Technology that allows for an outside the box connection of up to 2 meters (when using the cable defined in SATA-IO)



5.16.3 Theory of Operation

5.16.3.1 Standard ATA Emulation

The PCH contains a set of registers that shadow the contents of the legacy IDE registers. The behavior of the Command and Control Block registers, PIO, and DMA data transfers, resets, and interrupts are all emulated.

Note: The PCH will assert INTR when the master device completes the EDD command regardless of the command completion status of the slave device. If the master completes EDD first, an INTR is generated and BSY will remain '1' until the slave completes the command. If the slave completes EDD first, BSY will be '0' when the master completes the EDD command and asserts INTR. Software must wait for busy to clear (0) before completing an EDD command, as required by the ATA5 through ATA7 (T13) industry standards.

5.16.3.2 48-Bit LBA Operation

The SATA host controller supports 48-bit LBA through the host-to-device register FIS when accesses are performed using writes to the task file. The SATA host controller will ensure that the correct data is put into the correct byte of the host-to-device FIS.

There are special considerations when reading from the task file to support 48-bit LBA operation. Software may need to read all 16-bits. Since the registers are only 8-bits wide and act as a FIFO, a bit must be set in the device/control register, which is at offset 3F6h for primary and 376h for secondary (or their native counterparts).

If software clears Bit 7 of the control register before performing a read, the last item written will be returned from the FIFO. If software sets Bit 7 of the control register before performing a read, the first item written will be returned from the FIFO.

5.16.4 SATA Swap Bay Support

The PCH provides for basic SATA swap bay support using the PSC register configuration bits and power management flows. A device can be powered down by software and the port can then be disabled, allowing removal and insertion of a new device.

Note: This SATA swap bay operation requires board hardware (implementation specific), BIOS, and operating system support.

5.16.5 Hot Plug Operation

The PCH supports Hot Plug Surprise removal and Insertion Notification in the PARTIAL, SLUMBER and Listen Mode states when used with Low Power Device Presence Detection. Software can take advantage of power savings in the low power states while enabling hot plug operation. Refer to chapter 7 of the AHCI specification for details.

5.16.5.1 Low Power Device Presence Detection

Low Power Device Presence Detection enables SATA Link Power Management to co-exist with hot plug (insertion and removal) without interlock switch or cold presence detect. The detection mechanism allows Hot Plug events to be detectable by hardware across all link power states (Active, PARTIAL, SLUMBER) as well as AHCI Listen Mode.

If the Low Power Device Presence Detection circuit is disabled the PCH reverts to Hot Plug Surprise Removal Notification (without an interlock switch) mode that is mutually exclusive of the PARTIAL and SLUMBER power management states.



5.16.6 Function Level Reset Support (FLR)

The SATA Host Controller supports the Function Level Reset (FLR) capability. The FLR capability can be used in conjunction with Intel Virtualization Technology. FLR allows an operating system in a Virtual Machine to have complete control over a device, including its initialization, without interfering with the rest of the platform. The device provides a software interface that enables the Operating System to reset the whole device as if a PCI reset was asserted.

5.16.6.1 FLR Steps

5.16.6.1.1 FLR Initialization

1. A FLR is initiated by software writing a '1' to the Initiate FLR bit.
2. All subsequent requests targeting the Function will not be claimed and will be Master Abort Immediate on the bus. This includes any configuration, I/O or Memory cycles, however, the Function shall continue to accept completions targeting the Function.

5.16.6.1.2 FLR Operation

The Function will Reset all configuration, I/O and memory registers of the Function except those indicated otherwise and reset all internal states of the Function to the default or initial condition.

5.16.6.1.3 FLR Completion

The Initiate FLR bit is reset (cleared) when the FLR reset is completed. This bit can be used to indicate to the software that the FLR reset is completed.

Note: From the time Initiate FLR bit is written to 1 software must wait at least 100 ms before accessing the function.

5.16.7 Intel® Rapid Storage Technology Configuration

The Intel Rapid Storage Technology offers several diverse options for RAID (redundant array of independent disks) to meet the needs of the end user. AHCI support provides higher performance and alleviates disk bottlenecks by taking advantage of the independent DMA engines that each SATA port offers in the PCH.

- RAID Level 0 performance scaling up to 4 drives, enabling higher throughput for data intensive applications such as video editing.
- Data security is offered through RAID Level 1, which performs mirroring.
- RAID Level 10 provides high levels of storage performance with data protection, combining the fault-tolerance of RAID Level 1 with the performance of RAID Level 0. By striping RAID Level 1 segments, high I/O rates can be achieved on systems that require both performance and fault-tolerance. RAID Level 10 requires 4 hard drives, and provides the capacity of two drives.
- RAID Level 5 provides highly efficient storage while maintaining fault-tolerance on 3 or more drives. By striping parity, and rotating it across all disks, fault tolerance of any single drive is achieved while only consuming 1 drive worth of capacity. That is, a 3 drive RAID 5 has the capacity of 2 drives, or a 4 drive RAID 5 has the capacity of 3 drives. RAID 5 has high read transaction rates, with a medium write rate. RAID 5 is well suited for applications that require high amounts of storage while maintaining fault tolerance.



By using the PCH's built-in Intel Rapid Storage Technology, there is no loss of PCI resources (request/grant pair) or add-in card slot.

Intel® Rapid Storage Technology functionality requires the following items:

1. The PCH SKU enabled for Intel® Rapid Storage Technology
2. Intel Rapid Storage Manager RAID Option ROM must be on the platform
3. Intel Rapid Storage Manager drivers, most recent revision.
4. At least two SATA hard disk drives (minimum depends on RAID configuration).

Intel Rapid Storage Technology is not available in the following configurations:

1. The SATA controller is in compatible mode.

5.16.7.1 Intel® Rapid Storage Manager RAID Option ROM

The Intel Rapid Storage Manager RAID Option ROM is a standard PnP Option ROM that is easily integrated into any System BIOS. When in place, it provides the following three primary functions:

- Provides a text mode user interface that allows the user to manage the RAID configuration on the system in a pre-operating system environment. Its feature set is kept simple to keep size to a minimum, but allows the user to create & delete RAID volumes and select recovery options when problems occur.
- Provides boot support when using a RAID volume as a boot disk. It does this by providing Int13 services when a RAID volume needs to be accessed by MS-DOS applications (such as NTLDR) and by exporting the RAID volumes to the System BIOS for selection in the boot order.
- At each boot up, provides the user with a status of the RAID volumes and the option to enter the user interface by pressing CTRL-I.

5.16.8 Intel® Smart Response Technology

Intel® Smart Response Technology is a disk caching solution that can provide improved computer system performance with improved power savings. It allows configuration of a computer systems with the advantage of having HDDs for maximum storage capacity with system performance at or near SSD performance levels.

5.16.9 Power Management Operation

Power management of the PCH SATA controller and ports will cover operations of the host controller and the SATA wire.

5.16.9.1 Power State Mappings

The D0 PCI power management state for device is supported by the PCH SATA controller.

SATA devices may also have multiple power states. From parallel ATA, three device states are supported through ACPI. They are:

- **D0** – Device is working and instantly available.
- **D1** – Device enters when it receives a STANDBY IMMEDIATE command. Exit latency from this state is in seconds
- **D3** – From the SATA device's perspective, no different than a D1 state, in that it is entered using the STANDBY IMMEDIATE command. However, an ACPI method is also called which will reset the device and then cut its power.

Each of these device states are subsets of the host controller's D0 state.

Finally, SATA defines three PHY layer power states, which have no equivalent mappings to parallel ATA. They are:

- **PHY READY** – PHY logic and PLL are both on and active
- **Partial** – PHY logic is powered, but in a reduced state. Exit latency is no longer than 10 ns
- **Slumber** – PHY logic is powered, but in a reduced state. Exit latency can be up to 10 ms.

Since these states have much lower exit latency than the ACPI D1 and D3 states, the SATA controller defines these states as sub-states of the device D0 state.

5.16.9.2 Power State Transitions

5.16.9.2.1 Partial and Slumber State Entry/Exit

The partial and slumber states save interface power when the interface is idle. It would be most analogous to PCI CLKRUN# (in power savings, not in mechanism), where the interface can have power saved while no commands are pending. The SATA controller defines PHY layer power management (as performed using primitives) as a driver operation from the host side, and a device proprietary mechanism on the device side. The SATA controller accepts device transition types, but does not issue any transitions as a host. All received requests from a SATA device will be ACKed.

When an operation is performed to the SATA controller such that it needs to use the SATA cable, the controller must check whether the link is in the Partial or Slumber states, and if so, must issue a COM_WAKE to bring the link back online. Similarly, the SATA device must perform the same action.

5.16.9.2.2 Device D1, D3 States

These states are entered after some period of time when software has determined that no commands will be sent to this device for some time. The mechanism for putting a device in these states does not involve any work on the host controller, other than sending commands over the interface to the device. The command most likely to be used in ATA/ATAPI is the "STANDBY IMMEDIATE" command.

5.16.9.2.3 Host Controller D3_{HOT} State

After the interface and device have been put into a low power state, the SATA host controller may be put into a low power state. This is performed using the PCI power management registers in configuration space. There are two very important aspects to note when using PCI power management.

1. When the power state is D3, only accesses to configuration space are allowed. Any attempt to access the memory or I/O spaces will result in master abort.
2. When the power state is D3, no interrupts may be generated, even if they are enabled. If an interrupt status bit is pending when the controller transitions to D0, an interrupt may be generated.

When the controller is put into D3, it is assumed that software has properly shut down the device and disabled the ports. Therefore, there is no need to sustain any values on the port wires. The interface will be treated as if no device is present on the cable, and power will be minimized.

When returning from a D3 state, an internal reset will not be performed.



5.16.9.2.4 Non-AHCI Mode PME# Generation

When in non-AHCI mode (legacy mode) of operation, the SATA controller does not generate PME#. This includes attach events (since the port must be disabled), or interlock switch events (using the SATAGP pins).

5.16.9.3 SMI Trapping (APM)

Device 31:Function2:Offset C0h (see Section 14.1.39) contain control for generating SMI# on accesses to the IDE I/O spaces. These bits map to the legacy ranges (1F0–1F7h, 3F6h, 170–177h, and 376h) and native IDE ranges defined by PCMDBA, PCTLBA, SCMDBA and SCTLBA. If the SATA controller is in legacy mode and is using these addresses, accesses to one of these ranges with the appropriate bit set causes the cycle to not be forwarded to the SATA controller, and for an SMI# to be generated. If an access to the Bus-Master IDE registers occurs while trapping is enabled for the device being accessed, then the register is updated, an SMI# is generated, and the device activity status bits (Section 14.1.40) are updated indicating that a trap occurred.

5.16.10 SATA Device Presence

In legacy mode, the SATA controller does not generate interrupts based on hot plug/unplug events. However, the SATA PHY does know when a device is connected (if not in a partial or slumber state), and it is beneficial to communicate this information to host software as this will greatly reduce boot times and resume times.

The flow used to indicate SATA device presence is shown in Figure 5-8. The 'PxE' bit refers to PCS.P[3:0]E bits, depending on the port being checked and the 'PxP' bits refer to the PCS.P[3:0]P bits, depending on the port being checked. If the PCS/PxP bit is set a device is present, if the bit is cleared a device is not present. If a port is disabled, software can check to see if a new device is connected by periodically re-enabling the port and observing if a device is present, if a device is not present it can disable the port and check again later. If a port remains enabled, software can periodically poll PCS.PxP to see if a new device is connected.

Figure 5-8. Flow for Port Enable / Device Present Bits

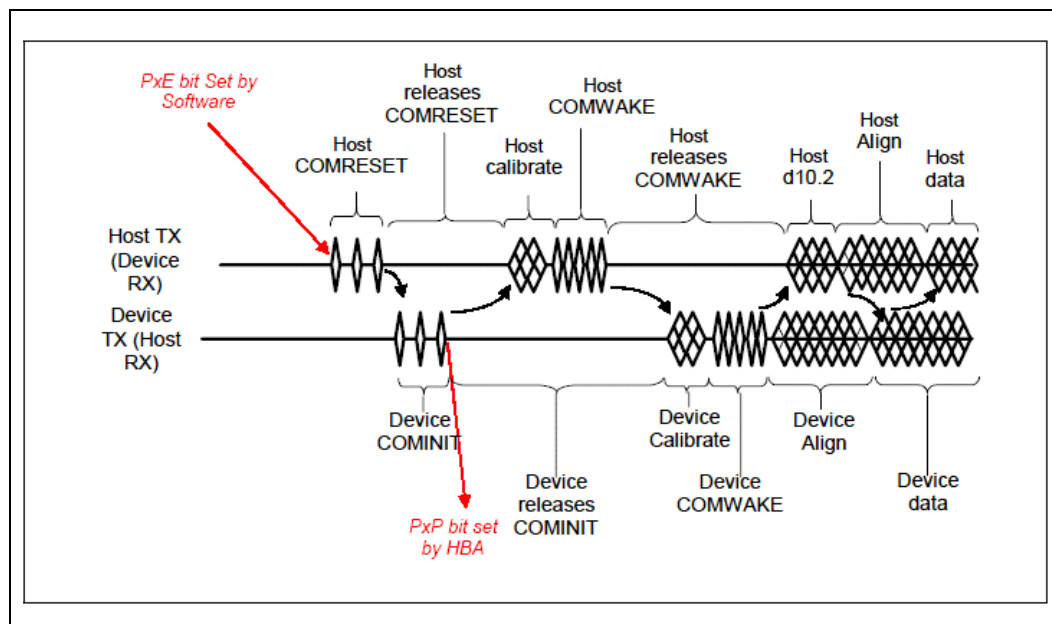

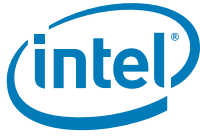

5.16.11 SATA LED

The SATALED# output is driven whenever the BSY bit is set in any SATA port. The SATALED# is an active-low open-drain output. When SATALED# is low, the LED should be active. When SATALED# is high, the LED should be inactive.

5.16.12 AHCI Operation

The PCH provides hardware support for Advanced Host Controller Interface (AHCI), a programming interface for SATA host controllers developed through a joint industry effort. AHCI defines transactions between the SATA controller and software and enables advanced performance and usability with SATA. Platforms supporting AHCI may take advantage of performance features such as no master/slave designation for SATA devices—each device is treated as a master—and hardware assisted native command queuing. AHCI also provides usability enhancements such as Hot-Plug. AHCI requires appropriate software support (such as, an AHCI driver) and for some features, hardware support in the SATA device or additional platform hardware.

The PCH supports all of the mandatory features of the *Serial ATA Advanced Host Controller Interface Specification*, Revision 1.2 and many optional features, such as hardware assisted native command queuing, aggressive power management, LED indicator support, and Hot-Plug through the use of interlock switch support (additional platform hardware and software may be required depending upon the implementation).

Note: For reliable device removal notification while in AHCI operation without the use of interlock switches (surprise removal), interface power management should be disabled for the associated port. See Section 7.3.1 of the *AHCI Specification* for more information.

5.16.13 SGPIO Signals

The SGPIO signals, in accordance to the SFF-8485 specification, support per-port LED signaling. These signals are not related to SATALED#, which allows for simplified indication of SATA command activity. The SGPIO group interfaces with an external controller chip that fetches and serializes the data for driving across the SGPIO bus. The output signals then control the LEDs. This feature is only valid in AHCI/RAID mode.

5.16.13.1 Mechanism

The enclosure management for SATA Controller 1 (Device 31: Function 2) involves sending messages that control LEDs in the enclosure. The messages for this function are stored after the normal registers in the AHCI BAR, at Offset 580h bytes for the PCH from the beginning of the AHCI BAR as specified by the EM_LOC global register (Section 14.4.1.6).

Software creates messages for transmission in the enclosure management message buffer. The data in the message buffer should not be changed if CTL.TM bit is set by software to transmit an update message. Software should only update the message buffer when CTL.TM bit is cleared by hardware otherwise the message transmitted will be indeterminate. Software then writes a register to cause hardware to transmit the message or take appropriate action based on the message content. The software should only create message types supported by the controller, which is LED messages for the PCH. If the software creates other non LED message types (such as, SAF-TE, SES-2), the SGPIO interface may hang and the result is indeterminate.

During reset all SGPIO pins will be in tri-state. The interface will continue to be in tri-state after reset until the first transmission occurs when software programs the message buffer and sets the transmit bit CTL.TM. The SATA Host controller will initiate the transmission by driving SCLOCK and at the same time drive the SLOAD to '0' prior



to the actual bit stream transmission. The Host will drive SLOAD low for at least 5 SCLOCK then only start the bit stream by driving the SLOAD to high. SLOAD will be driven high for 1 SCLOCK follow by vendor specific pattern that is default to "0000" if software has yet to program the value. A total of 21-bit stream from 7 ports (Port0, Port1, Port2, Port3, Port4 Port5 and Port6) of 3-bit per port LED message will be transmitted on SDATAOUT0 pin after the SLOAD is driven high for 1 SCLOCK. Only 3 ports (Port4, Port5 and Port6) of 9 bit total LED message follow by 12 bits of tri-state value will be transmitted out on SDATAOUT1 pin.

All the default LED message values will be high prior to software setting them, except the Activity LED message that is configured to be hardware driven that will be generated based on the activity from the respective port. All the LED message values will be driven to '1' for the port that is unimplemented as indicated in the Port Implemented register regardless of the software programmed value through the message buffer.

There are 2 different ways of resetting the PCH's SGPIO interface, asynchronous reset and synchronous reset. Asynchronous reset is caused by platform reset to cause the SGPIO interface to be tri-state asynchronously. Synchronous reset is caused by setting the CTL.RESET bit, clearing the GHC.AE bit or HBA reset, where Host Controller will complete the existing full bit stream transmission then only tri-state all the SGPIO pins. After the reset, both synchronous and asynchronous, the SGPIO pins will stay tri-stated.

Note: The PCH Host Controller does not ensure that it will cause the target SGPIO device or controller to be reset. Software is responsible to keep the PCH SGPIO interface in tri-state for 2 second to cause a reset on the target of the SGPIO interface.

5.16.13.2 Message Format

Messages shall be constructed with a one DWord header that describes the message to be sent followed by the actual message contents. The first DWord shall be constructed as follows:

Bit	Description
31:28	Reserved
27:24	<p>Message Type (MTYPE): Specifies the type of the message.</p> <p>The message types are:</p> <p>0h = LED</p> <p>1h = SAF-TE</p> <p>2h = SES-2</p> <p>3h = SGPIO (register based interface)</p> <p>All other values reserved</p>
23:16	<p>Data Size (DSIZE): Specifies the data size in bytes. If the message (enclosure services command) has a data buffer that is associated with it that is transferred, the size of that data buffer is specified in this field. If there is no separate data buffer, this field shall have a value of '0'. The data directly follows the message in the message buffer. For the PCH, this value should always be '0'.</p>
15:8	<p>Message Size (MSIZE): Specifies the size of the message in bytes. The message size does not include the one DWord header. A value of '0' is invalid. For the PCH, the message size is always 4 bytes.</p>
7:0	Reserved

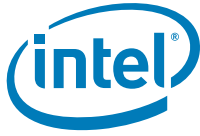

The SAF-TE, SES-2, and SGPIO message formats are defined in the corresponding specifications, respectively. The LED message type is defined in [Section 5.16.13.3](#). It is the responsibility of software to ensure the content of the message format is correct. If the message type is not programmed as 'LED' for this controller, the controller shall not take any action to update its LEDs. Note that for LED message type, the message size is always consisted of 4 bytes.

5.16.13.3 LED Message Type

The LED message type specifies the status of up to three LEDs. Typically, the usage for these LEDs is activity, fault, and locate. Not all implementations necessarily contain all LEDs (for example, some implementations may not have a locate LED). The message identifies the HBA port number and the Port Multiplier port number that the slot status applies to. If a Port Multiplier is not in use with a particular device, the Port Multiplier port number shall be '0'. The format of the LED message type is defined in [Table 5-40](#). The LEDs shall retain their values until there is a following update for that particular slot.

Table 5-40. Multi-activity LED Message Type

Byte	Description
3-2	<p>Value (VAL): This field describes the state of each LED for a particular location. There are three LEDs that may be supported by the HBA. Each LED has 3 bits of control.</p> <p>LED values are: 000b – LED shall be off 001b – LED shall be solid on as perceived by human eye All other values reserved</p> <p>The LED bit locations are: Bits 2:0 – Activity LED (may be driven by hardware) Bits 5:3 – Vendor Specific LED (such as locate) Bits 8:6 – Vendor Specific LED (such as fault) Bits 15:9 – Reserved</p> <p>Vendor specific message is: Bit 3:0 – Vendor Specific Pattern Bit 15:4 – Reserved</p> <p>NOTE: If Activity LED Hardware Driven (ATTR.ALHD) bit is set, host will output the hardware LED value sampled internally and will ignore software written activity value on bit [2:0]. Since the PCH Enclosure Management does not support port multiplier based LED message, the LED message will be generated independently based on respective port's operation activity. Vendor specific LED values Locate (Bits 5:3) and Fault (Bits 8:6) always are driven by software.</p>
1	<p>Port Multiplier Information: Specifies slot specific information related to Port Multiplier. Bits 3:0 specify the Port Multiplier port number for the slot that requires the status update. If a Port Multiplier is not attached to the device in the affected slot, the Port Multiplier port number shall be '0'. Bits 7:4 are reserved. The PCH does not support LED messages for devices behind a Port Multiplier. This byte should be 0.</p>
0	<p>HBA Information: Specifies slot specific information related to the HBA. Bits 4:0 – HBA port number for the slot that requires the status update. Bit 5 – If set to '1', value is a vendor specific message that applies to the entire enclosure. If cleared to '0', value applies to the port specified in bits 4:0. Bits 7:6 – Reserved</p>

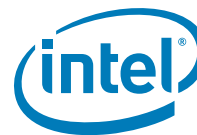

5.16.13.4 SGPIO Waveform

Figure 5-9. Serial Data transmitted over the SGPIO Interface

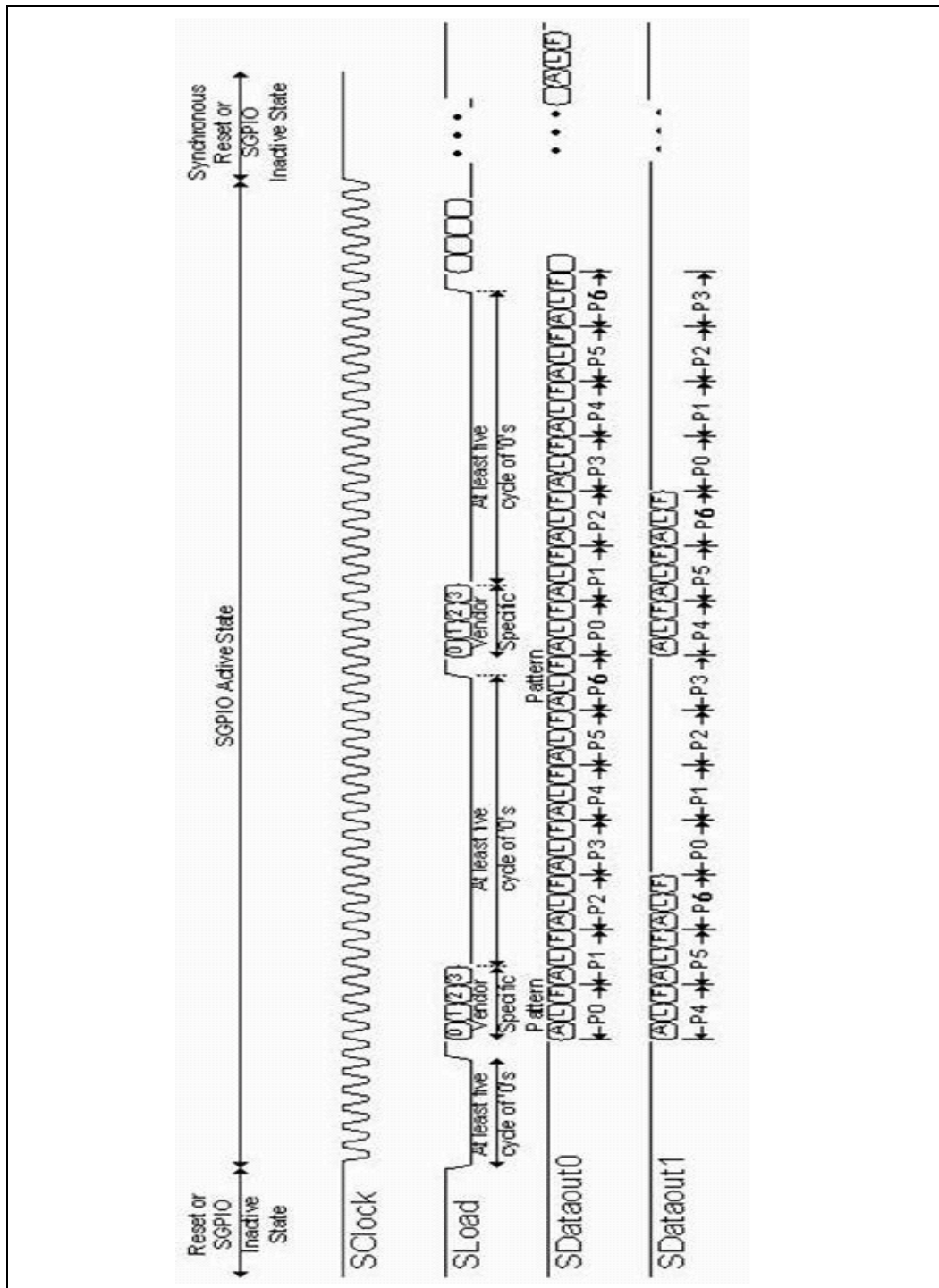



5.16.14 External SATA

The PCH supports external SATA. External SATA utilizes the SATA interface outside of the system box. The usage model for this feature must comply with the Serial ATA II Cables and Connectors Volume 2 Gold specification at www.sata-io.org. Intel validates two configurations:

1. The cable-up solution involves an internal SATA cable that connects to the SATA motherboard connector and spans to a back panel PCI bracket with an eSATA connector. A separate eSATA cable is required to connect an eSATA device.
2. The back-panel solution involves running a trace to the I/O back panel and connecting a device using an external SATA connector on the board.

5.17 High Precision Event Timers

This function provides a set of timers that can be used by the operating system. The timers are defined such that in the future, the operating system may be able to assign specific timers to used directly by specific applications. Each timer can be configured to cause a separate interrupt.

The PCH provides eight timers. The timers are implemented as a single counter, each with its own comparator and value register. This counter increases monotonically. Each individual timer can generate an interrupt when the value in its value register matches the value in the main counter.

The registers associated with these timers are mapped to a memory space (much like the I/O APIC). However, it is not implemented as a standard PCI function. The BIOS reports to the operating system the location of the register space. The hardware can support an assignable decode space; however, the BIOS sets this space prior to handing it over to the operating system. It is not expected that the operating system will move the location of these timers once it is set by the BIOS.

5.17.1 Timer Accuracy

1. The timers are accurate over any 1 ms period to within 0.05% of the time specified in the timer resolution fields.
2. Within any 100 microsecond period, the timer reports a time that is up to two ticks too early or too late. Each tick is less than or equal to 100 ns, so this represents an error of less than 0.2%.
3. The timer is monotonic. It does not return the same value on two consecutive reads (unless the counter has rolled over and reached the same value).

The main counter is clocked by the 14.31818 MHz clock, synchronized into the 66.666 MHz domain. This results in a non-uniform duty cycle on the synchronized clock, but does have the correct average period. The accuracy of the main counter is as accurate as the 14.31818 MHz clock.



5.17.2 Interrupt Mapping

Mapping Option #1 (Legacy Replacement Option)

In this case, the Legacy Replacement Rout bit (LEG_RT_CNF) is set. This forces the mapping found in [Table 5-41](#).

Table 5-41. Legacy Replacement Routing

Timer	8259 Mapping	APIC Mapping	Comment
0	IRQ0	IRQ2	In this case, the 8254 timer will not cause any interrupts
1	IRQ8	IRQ8	In this case, the RTC will not cause any interrupts.
2 & 3	Per IRQ Routing Field.	Per IRQ Routing Field	
4, 5, 6, 7	not available	not available	

NOTE: The Legacy Option does not preclude delivery of IRQ0/IRQ8 using direct FSB interrupt messages.

Mapping Option #2 (Standard Option)

In this case, the Legacy Replacement Rout bit (LEG_RT_CNF) is 0. Each timer has its own routing control. The interrupts can be routed to various interrupts in the 8259 or I/O APIC. A capabilities field indicates which interrupts are valid options for routing. If a timer is set for edge-triggered mode, the timers should not be shared with any PCI interrupts.

For the PCH, the only supported interrupt values are as follows:

Timer 0 and 1: IRQ20, 21, 22 & 23 (I/O APIC only).

Timer 2: IRQ11 (8259 or I/O APIC) and IRQ20, 21, 22 & 23 (I/O APIC only).

Timer 3: IRQ12 (8259 or I/O APIC) and IRQ 20, 21, 22 & 23 (I/O APIC only).

Interrupts from Timer 4, 5, 6, 7 can only be delivered using direct FSB interrupt messages.

5.17.3 Periodic versus Non-Periodic Modes

Non-Periodic Mode

Timer 0 is configurable to 32 (default) or 64-bit mode, whereas Timers 1, 2 and 3 only support 32-bit mode (See [Section 20.1.5](#)).

All of the timers support non-periodic mode.

Refer to Section 2.3.9.2.1 of the IA-PC HPET Specification for a description of this mode.

Periodic Mode

Timer 0 is the only timer that supports periodic mode. Refer to Section 2.3.9.2.2 of the *IA-PC HPET Specification* for a description of this mode.

The following usage model is expected:

1. Software clears the ENABLE_CNF bit to prevent any interrupts.
2. Software Clears the main counter by writing a value of 00h to it.
3. Software sets the TIMER0_VAL_SET_CNF bit.
4. Software writes the new value in the TIMER0_COMPARATOR_VAL register.
5. Software sets the ENABLE_CNF bit to enable interrupts.

The Timer 0 Comparator Value register cannot be programmed reliably by a single 64-bit write in a 32-bit environment except if only the periodic rate is being changed during run-time. If the actual Timer 0 Comparator Value needs to be reinitialized, then the following software solution will always work regardless of the environment:

1. Set TIMER0_VAL_SET_CNF bit.
2. Set the lower 32 bits of the Timer0 Comparator Value register.
3. Set TIMER0_VAL_SET_CNF bit.
4. Set the upper 32 bits of the Timer0 Comparator Value register.

5.17.4 Enabling the Timers

The BIOS or operating system PnP code should route the interrupts. This includes the Legacy Rout bit, Interrupt Rout bit (for each timer), interrupt type (to select the edge or level type for each timer)

The Device Driver code should do the following for an available timer:

1. Set the Overall Enable bit (Offset 10h, bit 0).
2. Set the timer type field (selects one-shot or periodic).
3. Set the interrupt enable.
4. Set the comparator value.



5.17.5 Interrupt Levels

Interrupts directed to the internal 8259s are active high. See [Section 5.9](#) for information regarding the polarity programming of the I/O APIC for detecting internal interrupts.

If the interrupts are mapped to the 8259 or I/O APIC and set for level-triggered mode, they can be shared with PCI interrupts. They may be shared although it is unlikely for the operating system to attempt to do this.

If more than one timer is configured to share the same IRQ (using the `TIMERn_INT_ROUT_CNF` fields), then the software must configure the timers to level-triggered mode. Edge-triggered interrupts cannot be shared.

5.17.6 Handling Interrupts

If each timer has a unique interrupt and the timer has been configured for edge-triggered mode, then there are no specific steps required. No read is required to process the interrupt.

If a timer has been configured to level-triggered mode, then its interrupt must be cleared by the software. This is done by reading the interrupt status register and writing a 1 back to the bit position for the interrupt to be cleared.

Independent of the mode, software can read the value in the main counter to see how time has passed between when the interrupt was generated and when it was first serviced.

If Timer 0 is set up to generate a periodic interrupt, the software can check to see how much time remains until the next interrupt by checking the timer value register.

5.17.7 Issues Related to 64-Bit Timers with 32-Bit Processors

A 32-bit timer can be read directly using processors that are capable of 32-bit or 64-bit instructions. However, a 32-bit processor may not be able to directly read 64-bit timer. A race condition comes up if a 32-bit processor reads the 64-bit register using two separate 32-bit reads. The danger is that just after reading one half, the other half rolls over and changes the first half.

If a 32-bit processor needs to access a 64-bit timer, it must first halt the timer before reading both the upper and lower 32-bits of the timer. If a 32-bit processor does not want to halt the timer, it can use the 64-bit timer as a 32-bit timer by setting the `TIMERn_32MODE_CNF` bit. This causes the timer to behave as a 32-bit timer. The upper 32-bits are always 0.

Alternatively, software may do a multiple read of the counter while it is running. Software can read the high 32 bits, then the low 32 bits, the high 32 bits again. If the high 32 bits have not changed between the two reads, then a rollover has not happened and the low 32 bits are valid. If the high 32 bits have changed between reads, then the multiple reads are repeated until a valid read is performed.

Note: On a 64-bit platform, if software attempts a 64 bit read of the 64-bit counter, software must be aware that some platforms may split the 64 bit read into two 32 bit reads. The read maybe inaccurate if the low 32 bits roll over between the high and low reads.



5.18 USB EHCI Host Controllers (D29:F0 and D26:F0)

The PCH contains two Enhanced Host Controller Interface (EHCI) host controllers which support up to fourteen USB 2.0 high-speed root ports. USB 2.0 allows data transfers up to 480 Mb/s. USB 2.0 based Debug Port is also implemented in the PCH.

5.18.1 EHC Initialization

The following descriptions step through the expected PCH Enhanced Host Controller (EHC) initialization sequence in chronological order, beginning with a complete power cycle in which the suspend well and core well have been off.

5.18.1.1 BIOS Initialization

BIOS performs a number of platform customization steps after the core well has powered up. Contact your Intel Field Representative for additional PCH BIOS information.

5.18.1.2 Driver Initialization

See Chapter 4 of the *Enhanced Host Controller Interface Specification for Universal Serial Bus*, Revision 1.0.

5.18.1.3 EHC Resets

In addition to the standard PCH hardware resets, portions of the EHC are reset by the HCRESET bit and the transition from the D3_{HOT} device power management state to the D0 state. The effects of each of these resets are:

Reset Done	Resets	Does Not Reset	Comments
HCRESET bit set.	Memory space registers except Structural Parameters (which is written by BIOS).	Configuration registers.	The HCRESET must only affect registers that the EHCI driver controls. PCI Configuration space and BIOS-programmed parameters cannot be reset.
Software writes the Device Power State from D3 _{HOT} (11b) to D0 (00b).	Core well registers (except BIOS-programmed registers).	Suspend well registers; BIOS-programmed core well registers.	The D3-to-D0 transition must not cause wake information (suspend well) to be lost. It also must not clear BIOS-programmed registers because BIOS may not be invoked following the D3-to-D0 transition.

If the detailed register descriptions give exceptions to these rules, those exceptions override these rules. This summary is provided to help explain the reasons for the reset policies.

5.18.2 Data Structures in Main Memory

See Section 3 and Appendix B of the *Enhanced Host Controller Interface Specification for Universal Serial Bus*, Revision 1.0 for details.



5.18.3 USB 2.0 Enhanced Host Controller DMA

The PCH USB 2.0 EHC implements three sources of USB packets. They are, in order of priority on USB during each microframe:

1. The USB 2.0 Debug Port (see Section USB 2.0 Based Debug Port),
2. The Periodic DMA engine, and
3. The Asynchronous DMA engine.

The PCH always performs any currently-pending debug port transaction at the beginning of a microframe, followed by any pending periodic traffic for the current microframe. If there is time left in the microframe, then the EHC performs any pending asynchronous traffic until the end of the microframe (EOF1). Note that the debug port traffic is only presented on Port 1 and Port 9, while the other ports are idle during this time.

5.18.4 Data Encoding and Bit Stuffing

See Chapter 8 of the *Universal Serial Bus Specification, Revision 2.0*.

5.18.5 Packet Formats

See Chapter 8 of the *Universal Serial Bus Specification, Revision 2.0*.

The PCH EHCI allows entrance to USB test modes, as defined in the USB 2.0 specification, including Test J, Test Packet, etc. However note that the PCH Test Packet test mode interpacket gap timing may not meet the USB 2.0 specification.

5.18.6 USB 2.0 Interrupts and Error Conditions

Section 4 of the *Enhanced Host Controller Interface Specification for Universal Serial Bus, Revision 1.0* goes into detail on the EHC interrupts and the error conditions that cause them. All error conditions that the EHC detects can be reported through the EHCI Interrupt status bits. Only PCH-specific interrupt and error-reporting behavior is documented in this section. The EHCI Interrupts Section must be read first, followed by this section of the datasheet to fully comprehend the EHC interrupt and error-reporting functionality.

- Based on the EHC Buffer sizes and buffer management policies, the Data Buffer Error can never occur on the PCH.
- Master Abort and Target Abort responses from hub interface on EHC-initiated read packets will be treated as Fatal Host Errors. The EHC halts when these conditions are encountered.
- The PCH may assert the interrupts which are based on the interrupt threshold as soon as the status for the last complete transaction in the interrupt interval has been posted in the internal write buffers. The requirement in the *Enhanced Host Controller Interface Specification for Universal Serial Bus, Revision 1.0* (that the status is written to memory) is met internally, even though the write may not be seen on DMI before the interrupt is asserted.
- Since the PCH supports the 1024-element Frame List size, the Frame List Rollover interrupt occurs every 1024 milliseconds.
- The PCH delivers interrupts using PIRQH#.
- The PCH does not modify the CERR count on an Interrupt IN when the "Do Complete-Split" execution criteria are not met.
- For complete-split transactions in the Periodic list, the "Missed Microframe" bit does not get set on a control-structure-fetch that fails the late-start test. If subsequent accesses to that control structure do not fail the late-start test, then the "Missed Microframe" bit will get set and written back.

5.18.6.1 Aborts on USB 2.0-Initiated Memory Reads

If a read initiated by the EHC is aborted, the EHC treats it as a fatal host error. The following actions are taken when this occurs:

- The Host System Error status bit is set.
- The DMA engines are halted after completing up to one more transaction on the USB interface.
- If enabled (by the Host System Error Enable), then an interrupt is generated.
- If the status is Master Abort, then the Received Master Abort bit in configuration space is set.
- If the status is Target Abort, then the Received Target Abort bit in configuration space is set.
- If enabled (by the SERR Enable bit in the function's configuration space), then the Signaled System Error bit in configuration bit is set.

5.18.7 USB 2.0 Power Management

5.18.7.1 Pause Feature

This feature allows platforms to dynamically enter low-power states during brief periods when the system is idle (that is, between keystrokes). This is useful for enabling power management features in the PCH. The policies for entering these states typically are based on the recent history of system bus activity to incrementally enter deeper power management states. Normally, when the EHC is enabled, it regularly accesses main memory while traversing the DMA schedules looking for work to do; this activity is viewed by the power management software as a non-idle system, thus preventing the power managed states to be entered. Suspending all of the enabled ports can prevent the memory accesses from occurring, but there is an inherent latency overhead with entering and exiting the suspended state on the USB ports that makes this unacceptable for the purpose of dynamic power management. As a result, the EHCI software drivers are allowed to pause the EHC DMA engines when it knows that the traffic patterns of the attached devices can afford the delay. The pause only prevents the EHC from generating memory accesses; the SOF packets continue to be generated on the USB ports (unlike the suspended state).

5.18.7.2 Suspend Feature

The *Enhanced Host Controller Interface (EHCI) For Universal Serial Bus Specification*, Section 4.3 describes the details of Port Suspend and Resume.

5.18.7.3 ACPI Device States

The USB 2.0 function only supports the D0 and D3 PCI Power Management states. Notes regarding the PCH implementation of the Device States:

1. The EHC hardware does not inherently consume any more power when it is in the D0 state than it does in the D3 state. However, software is required to suspend or disable all ports prior to entering the D3 state such that the maximum power consumption is reduced.
2. In the D0 state, all implemented EHC features are enabled.
3. In the D3 state, accesses to the EHC memory-mapped I/O range will master abort. Note that, since the Debug Port uses the same memory range, the Debug Port is only operational when the EHC is in the D0 state.
4. In the D3 state, the EHC interrupt must never assert for any reason. The internal PME# signal is used to signal wake events, etc.
5. When the Device Power State field is written to D0 from D3, an internal reset is generated. See section EHC Resets for general rules on the effects of this reset.
6. Attempts to write any other value into the Device Power State field other than 00b (D0 state) and 11b (D3 state) will complete normally without changing the current value in this field.



5.18.7.4 ACPI System States

The EHC behavior as it relates to other power management states in the system is summarized in the following list:

- The System is always in the S0 state when the EHC is in the D0 state. However, when the EHC is in the D3 state, the system may be in any power management state (including S0).
- When in D0, the Pause feature (See [Section 5.18.7.1](#)) enables dynamic processor low-power states to be entered.
- The PLL in the EHC is disabled when entering the S3/S4/S5 states (core power turns off).
- All core well logic is reset in the S3/S4/S5 states.

5.18.8 USB 2.0 Legacy Keyboard Operation

The PCH must support the possibility of a keyboard downstream from either a full-speed/low-speed or a high-speed port. The description of the legacy keyboard support is unchanged from USB 1.1.

The EHC provides the basic ability to generate SMIs on an interrupt event, along with more sophisticated control of the generation of SMIs.

5.18.9 USB 2.0 Based Debug Port

The PCH supports the elimination of the legacy COM ports by providing the ability for new debugger software to interact with devices on a USB 2.0 port.

High-level restrictions and features are:

- Operational before USB 2.0 drivers are loaded.
- Functions even when the port is disabled.
- Allows normal system USB 2.0 traffic in a system that may only have one USB port.
- Debug Port device (DPD) must be high-speed capable and connect directly to Port 1 and Port 9 on PCH-based systems (such as, the DPD cannot be connected to Port 1/Port 9 through a hub. When a DPD is detected the PCH EHCI will bypass the integrated Rate Matching Hub and connect directly to the port and the DPD.).
- Debug Port FIFO always makes forward progress (a bad status on USB is simply presented back to software).
- The Debug Port FIFO is only given one USB access per microframe.

The Debug port facilitates operating system and device driver debug. It allows the software to communicate with an external console using a USB 2.0 connection. Because the interface to this link does not go through the normal USB 2.0 stack, it allows communication with the external console during cases where the operating system is not loaded, the USB 2.0 software is broken, or where the USB 2.0 software is being debugged. Specific features of this implementation of a debug port are:

- Only works with an external USB 2.0 debug device (console)
- Implemented for a specific port on the host controller
- Operational anytime the port is not suspended AND the host controller is in D0 power state.
- Capability is interrupted when port is driving USB RESET

5.18.9.1 Theory of Operation

There are two operational modes for the USB debug port:

1. Mode 1 is when the USB port is in a disabled state from the viewpoint of a standard host controller driver. In Mode 1, the Debug Port controller is required to generate a “keepalive” packets less than 2 ms apart to keep the attached debug device from suspending. The keepalive packet should be a standalone 32-bit SYNC field.
2. Mode 2 is when the host controller is running (that is, host controller’s *Run/Stop#* bit is 1). In Mode 2, the normal transmission of SOF packets will keep the debug device from suspending.

Behavioral Rules

1. In both modes 1 and 2, the Debug Port controller must check for software requested debug transactions at least every 125 microseconds.
2. If the debug port is enabled by the debug driver, and the standard host controller driver resets the USB port, USB debug transactions are held off for the duration of the reset and until after the first SOF is sent.
3. If the standard host controller driver suspends the USB port, then USB debug transactions are held off for the duration of the suspend/resume sequence and until after the first SOF is sent.
4. The ENABLED_CNT bit in the debug register space is independent of the similar port control bit in the associated Port Status and Control register.

Table 5-42 shows the debug port behavior related to the state of bits in the debug registers as well as bits in the associated Port Status and Control register.

Table 5-42. Debug Port Behavior

OWNER_CNT	ENABLED_CT	Port Enable	Run / Stop	Suspend De	bug Port Behavior
0	X	X	X	X	Debug port is not being used. Normal operation.
1	0	X	X	X	Debug port is not being used. Normal operation.
1	1	0	0	X	Debug port in Mode 1. SYNC keepalives sent plus debug traffic
1	1	0	1	X	Debug port in Mode 2. SOF (and only SOF) is sent as keepalive. Debug traffic is also sent. Note that no other normal traffic is sent out this port, because the port is not enabled.
1	1	1	0	0	Invalid. Host controller driver should never put controller into this state (enabled, not running and not suspended).
1	1	1	0	1	Port is suspended. No debug traffic sent.
1	1	1	1	0	Debug port in Mode 2. Debug traffic is interspersed with normal traffic.
1	1	1	1	1	Port is suspended. No debug traffic sent.



5.18.9.1.1 OUT Transactions

An Out transaction sends data to the debug device. It can occur only when the following are true:

- The debug port is enabled
- The debug software sets the GO_CNT bit
- The WRITE_READ#_CNT bit is set

The sequence of the transaction is:

1. Software sets the appropriate values in the following bits:
 - USB_ADDRESS_CNF
 - USB_ENDPOINT_CNF
 - DATA_BUFFER[63:0]
 - TOKEN_PID_CNT[7:0]
 - SEND_PID_CNT[15:8]
 - DATA_LEN_CNT
 - WRITE_READ#_CNT: (Note: This will always be 1 for OUT transactions.)
 - GO_CNT: (Note: This will always be 1 to initiate the transaction.)
2. The debug port controller sends a token packet consisting of:
 - SYNC
 - TOKEN_PID_CNT field
 - USB_ADDRESS_CNT field
 - USB_ENDPOINT_CNT field
 - 5-bit CRC field
3. After sending the token packet, the debug port controller sends a data packet consisting of:
 - SYNC
 - SEND_PID_CNT field
 - The number of data bytes indicated in DATA_LEN_CNT from the DATA_BUFFER
 - 16-bit CRC

NOTE: A DATA_LEN_CNT value of 0 is valid in which case no data bytes would be included in the packet.
4. After sending the data packet, the controller waits for a handshake response from the debug device.
 - If a handshake is received, the debug port controller:
 - a. Places the received PID in the RECEIVED_PID_STS field
 - b. Resets the ERROR_GOOD#_STS bit
 - c. Sets the DONE_STS bit
 - If no handshake PID is received, the debug port controller:
 - a. Sets the EXCEPTION_STS field to 001b
 - b. Sets the ERROR_GOOD#_STS bit
 - c. Sets the DONE_STS bit

5.18.9.1.2 IN Transactions

An IN transaction receives data from the debug device. It can occur only when the following are true:

- The debug port is enabled
- The debug software sets the GO_CNT bit
- The WRITE_READ#_CNT bit is reset

The sequence of the transaction is:

1. Software sets the appropriate values in the following bits:
 - USB_ADDRESS_CNF
 - USB_ENDPOINT_CNF
 - TOKEN_PID_CNT[7:0]
 - DATA_LEN_CNT
 - WRITE_READ#_CNT: (Note: This will always be 0 for IN transactions.)
 - GO_CNT: (Note: This will always be 1 to initiate the transaction.)
2. The debug port controller sends a token packet consisting of:
 - SYNC
 - TOKEN_PID_CNT field
 - USB_ADDRESS_CNF field
 - USB_ENDPOINT_CNF field
 - 5-bit CRC field.
3. After sending the token packet, the debug port controller waits for a response from the debug device.
If a response is received:
 - The received PID is placed into the RECEIVED_PID_STS field
 - Any subsequent bytes are placed into the DATA_BUFFER
 - The DATA_LEN_CNT field is updated to show the number of bytes that were received after the PID.
4. If a valid packet was received from the device that was one byte in length (indicating it was a handshake packet), then the debug port controller:
 - Resets the ERROR_GOOD#_STS bit
 - Sets the DONE_STS bit
5. If a valid packet was received from the device that was more than one byte in length (indicating it was a data packet), then the debug port controller:
 - Transmits an ACK handshake packet
 - Resets the ERROR_GOOD#_STS bit
 - Sets the DONE_STS bit
6. If no valid packet is received, then the debug port controller:
 - Sets the EXCEPTION_STS field to 001b
 - Sets the ERROR_GOOD#_STS bit
 - Sets the DONE_STS bit.



5.18.9.1.3 Debug Software

Enabling the Debug Port

There are two mutually exclusive conditions that debug software must address as part of its startup processing:

- The EHCI has been initialized by system software
- The EHCI has not been initialized by system software

Debug software can determine the current 'initialized' state of the EHCI by examining the Configure Flag in the EHCI USB 2.0 Command Register. If this flag is set, then system software has initialized the EHCI. Otherwise, the EHCI should not be considered initialized. Debug software will initialize the debug port registers depending on the state of the EHCI. However, before this can be accomplished, debug software must determine which root USB port is designated as the debug port.

Determining the Debug Port

Debug software can easily determine which USB root port has been designated as the debug port by examining bits 20:23 of the EHCI Host Controller Structural Parameters register. This 4-bit field represents the numeric value assigned to the debug port (that is, 0001=port 1).

Debug Software Startup with Non-Initialized EHCI

Debug software can attempt to use the debug port if after setting the OWNER_CNT bit, the Current Connect Status bit in the appropriate (See *Determining the Debug Port Presence*) PORTSC register is set. If the Current Connect Status bit is not set, then debug software may choose to terminate or it may choose to wait until a device is connected.

If a device is connected to the port, then debug software must reset/enable the port. Debug software does this by setting and then clearing the Port Reset bit the PORTSC register. To ensure a successful reset, debug software should wait at least 50 ms before clearing the Port Reset bit. Due to possible delays, this bit may not change to 0 immediately; reset is complete when this bit reads as 0. Software must not continue until this bit reads 0.

If a high-speed device is attached, the EHCI will automatically set the Port Enabled/Disabled bit in the PORTSC register and the debug software can proceed. Debug software should set the ENABLED_CNT bit in the Debug Port Control/Status register, and then reset (clear) the Port Enabled/Disabled bit in the PORTSC register (so that the system host controller driver does not see an enabled port when it is first loaded).

Debug Software Startup with Initialized EHCI

Debug software can attempt to use the debug port if the Current Connect Status bit in the appropriate (See *Determining the Debug Port*) PORTSC register is set. If the Current Connect Status bit is not set, then debug software may choose to terminate or it may choose to wait until a device is connected.

If a device is connected, then debug software must set the OWNER_CNT bit and then the ENABLED_CNT bit in the Debug Port Control/Status register.

Determining Debug Peripheral Presence

After enabling the debug port functionality, debug software can determine if a debug peripheral is attached by attempting to send data to the debug peripheral. If all attempts result in an error (Exception bits in the Debug Port Control/Status register indicates a Transaction Error), then the attached device is not a debug peripheral. If the debug port peripheral is not present, then debug software may choose to terminate or it may choose to wait until a debug peripheral is connected.

5.18.10 EHCI Caching

EHCI Caching is a power management feature in the USB (EHCI) host controllers which enables the controller to execute the schedules entirely in cache and eliminates the need for the DMA engine to access memory when the schedule is idle. EHCI caching allows the processor to maintain longer C-state residency times and provides substantial system power savings.

5.18.11 Intel® USB Pre-Fetch Based Pause

The Intel USB Pre-Fetch Based Pause is a power management feature in USB (EHCI) host controllers to ensure maximum C3/C4 processor power state time with C2 pop-up. This feature applies to the period schedule, and works by allowing the DMA engine to identify periods of idleness and preventing the DMA engine from accessing memory when the periodic schedule is idle. Typically in the presence of periodic devices with multiple millisecond poll periods, the periodic schedule will be idle for several frames between polls.

The Intel USB Pre-Fetch Based Pause feature is disabled by setting bit 4 of EHCI Configuration Register [Section 16.2.1](#).

5.18.12 Function Level Reset Support (FLR)

The USB EHCI Controllers support the Function Level Reset (FLR) capability. The FLR capability can be used in conjunction with Intel® Virtualization Technology. FLR allows an Operating System in a Virtual Machine to have complete control over a device, including its initialization, without interfering with the rest of the platform. The device provides a software interface that enables the Operating System to reset the whole device as if a PCI reset was asserted.

5.18.12.1 FLR Steps

5.18.12.1.1 FLR Initialization

1. A FLR is initiated by software writing a '1' to the Initiate FLR bit.
2. All subsequent requests targeting the Function will not be claimed and will be Master Abort Immediate on the bus. This includes any configuration, I/O or Memory cycles, however, the Function shall continue to accept completions targeting the Function.



5.18.12.1.2 FLR Operation

The Function will Reset all configuration, I/O and memory registers of the Function except those indicated otherwise and reset all internal states of the Function to the default or initial condition.

5.18.12.1.3 FLR Completion

The Initiate FLR bit is reset (cleared) when the FLR reset is completed. This bit can be used to indicate to the software that the FLR reset is completed.

Note: From the time Initiate FLR bit is written to 1, software must wait at least 100 ms before accessing the function.

5.18.13 USB Overcurrent Protection

The PCH has implemented programmable USB Overcurrent signals. The PCH provides a total of 8 overcurrent pins to be shared across the 14 ports.

Four overcurrent signals have been allocated to the ports in each USB Device:

- OC[3:0]# for Device 29 (Ports 0-7)
- OC[7:4]# for Device 26 (Ports 8-13)

Each pin is mapped to one or more ports by setting bits in the USBOCM1 and USBOCM2 registers. See [Section 10.1.51](#) and [Section 10.1.52](#). It is system BIOS' responsibility to ensure that each port is mapped to only one over current pin. Operation with more than one overcurrent pin mapped to a port is undefined. It is expected that multiple ports are mapped to a single overcurrent pin, however they should be connected at the port and not at the PCH pin. Shorting these pins together may lead to reduced test capabilities. By default, two ports are routed to each of the OC[6:0]# pins. OC7# is not used by default.

NOTES:

1. All USB ports routed out of the package must have Overcurrent protection. It is system BIOS responsibility to ensure all used ports have OC protection
2. USB Ports that are unused on the system (not routed out from the package) should not have OC pins assigned to them

5.19 Integrated USB 2.0 Rate Matching Hub

5.19.1 Overview

The PCH has integrated two USB 2.0 Rate Matching Hubs (RMH). One hub is connected to each of the EHCI controllers as shown in [Figure 5-10](#). The Hubs convert low and full-speed traffic into high-speed traffic. When the RMHs are enabled, they will appear to software like an external hub is connected to Port 0 of each EHCI controller. In addition, port 1 of each of the RMHs is multiplexed with Port 1 of the EHCI controllers and is able to bypass the RMH for use as the Debug Port.

The hub operates like any USB 2.0 Discrete Hub and will consume one tier of hubs allowed by the USB 2.0 Specification, section 4.1.1. A maximum of four additional non-root hubs can be supported on any of the PCH USB Ports. The RMH will report the following Vendor ID = 8087h and Product ID = 0024h.

Figure 5-10. EHCI with USB 2.0 with Rate Matching Hub

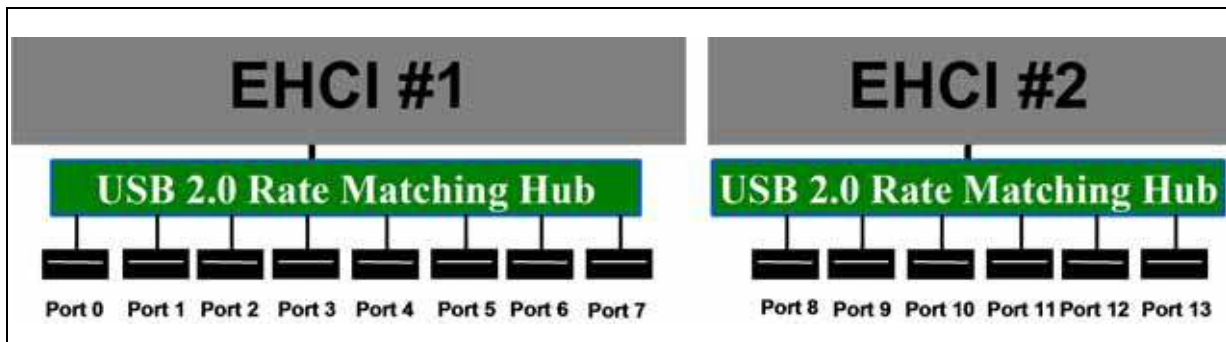

5.19.2 Architecture

A hub consists of three components: the Hub Repeater, the Hub Controller, and the Transaction Translator.

1. The Hub Repeater is responsible for connectivity setup and tear-down. It also supports exception handling, such as bus fault detection and recovery and connect/disconnect detect.
2. The Hub Controller provides the mechanism for host-to-hub communication. Hub-specific status and control commands permit the host to configure a hub and to monitor and control its individual downstream facing ports.
3. The Transaction Translator (TT) responds to high-speed split transactions and translates them to full-/low-speed transactions with full-/low-speed devices attached on downstream facing ports. There is 1 TT per RMH in the PCH.

See chapter 11 of the USB 2.0 Specification for more details on the architecture of the hubs.



5.20 SMBus Controller (D31:F3)

The PCH provides an System Management Bus (SMBus) 2.0 host controller as well as an SMBus Slave Interface. The host controller provides a mechanism for the processor to initiate communications with SMBus peripherals (slaves). The PCH is also capable of operating in a mode in which it can communicate with I²C compatible devices.

The PCH can perform SMBus messages with either packet error checking (PEC) enabled or disabled. The actual PEC calculation and checking is performed in hardware by the PCH.

The Slave Interface allows an external master to read from or write to the PCH. Write cycles can be used to cause certain events or pass messages, and the read cycles can be used to determine the state of various status bits. The PCH's internal host controller cannot access the PCH's internal Slave Interface.

The PCH SMBus logic exists in Device 31:Function 3 configuration space, and consists of a transmit data path, and host controller. The transmit data path provides the data flow logic needed to implement the seven different SMBus command protocols and is controlled by the host controller. The PCH's SMBus controller logic is clocked by RTC clock.

The SMBus Address Resolution Protocol (ARP) is supported by using the existing host controller commands through software, except for the new Host Notify command (which is actually a received message).

The programming model of the host controller is combined into two portions: a PCI configuration portion, and a system I/O mapped portion. All static configuration, such as the I/O base address, is done using the PCI configuration space. Real-time programming of the Host interface is done in system I/O space.

The PCH SMBus host controller checks for parity errors as a target. If an error is detected, the detected parity error bit in the PCI Status Register (Device 31:Function 3:Offset 06h:Bit 15) is set. If Bit 6 and Bit 8 of the PCI Command Register (Device 31:Function 3:Offset 04h) are set, an SERR# is generated and the signaled SERR# bit in the PCI Status Register (bit 14) is set.

5.20.1 Host Controller

The SMBus host controller is used to send commands to other SMBus slave devices. Software sets up the host controller with an address, command, and, for writes, data and optional PEC; and then tells the controller to start. When the controller has finished transmitting data on writes, or receiving data on reads, it generates an SMI# or interrupt, if enabled.

The host controller supports 8 command protocols of the SMBus interface (see *System Management Bus (SMBus) Specification, Version 2.0*): Quick Command, Send Byte, Receive Byte, Write Byte/Word, Read Byte/Word, Process Call, Block Read/Write, Block Write-Block Read Process Call, and Host Notify.

The SMBus host controller requires that the various data and command fields be setup for the type of command to be sent. When software sets the START bit, the SMBus Host controller performs the requested transaction, and interrupts the processor (or generates an SMI#) when the transaction is completed. Once a START command has been issued, the values of the "active registers" (Host Control, Host Command, Transmit Slave Address, Data 0, Data 1) should not be changed or read until the interrupt status message (INTR) has been set (indicating the completion of the command). Any register values needed for computation purposes should be saved prior to issuing of a new command, as the SMBus host controller updates all registers while completing the new command.

The PCH supports the *System Management Bus (SMBus) Specification, Version 2.0*. Slave functionality, including the Host Notify protocol, is available on the SMBus pins. The SMLink and SMBus signals can be tied together externally depending on TCO mode used. Refer to [Section 5.14.2](#) for more details.

Using the SMB host controller to send commands to the PCH SMB slave port is not supported.

5.20.1.1 Command Protocols

In all of the following commands, the Host Status Register (offset 00h) is used to determine the progress of the command. While the command is in operation, the HOST_BUSY bit is set. If the command completes successfully, the INTR bit will be set in the Host Status Register. If the device does not respond with an acknowledge, and the transaction times out, the DEV_ERR bit is set. If software sets the KILL bit in the Host Control Register while the command is running, the transaction will stop and the FAILED bit will be set.

Quick Command

When programmed for a Quick Command, the Transmit Slave Address Register is sent. The PEC byte is never appended to the Quick Protocol. Software should force the PEC_EN bit to 0 when performing the Quick Command. Software must force the I2C_EN bit to 0 when running this command. See section 5.5.1 of the *System Management Bus (SMBus) Specification, Version 2.0* for the format of the protocol.

Send Byte / Receive Byte

For the Send Byte command, the Transmit Slave Address and Device Command Registers are sent. For the Receive Byte command, the Transmit Slave Address Register is sent. The data received is stored in the DATA0 register. Software must force the I2C_EN bit to 0 when running this command.

The Receive Byte is similar to a Send Byte, the only difference is the direction of data transfer. See sections 5.5.2 and 5.5.3 of the *System Management Bus (SMBus) Specification, Version 2.0* for the format of the protocol.

Write Byte/Word

The first byte of a Write Byte/Word access is the command code. The next 1 or 2 bytes are the data to be written. When programmed for a Write Byte/Word command, the Transmit Slave Address, Device Command, and Data0 Registers are sent. In addition, the Data1 Register is sent on a Write Word command. Software must force the I2C_EN bit to 0 when running this command. See section 5.5.4 of the *System Management Bus (SMBus) Specification, Version 2.0* for the format of the protocol.

Read Byte/Word

Reading data is slightly more complicated than writing data. First the PCH must write a command to the slave device. Then it must follow that command with a repeated start condition to denote a read from that device's address. The slave then returns 1 or 2 bytes of data. Software must force the I2C_EN bit to 0 when running this command.

When programmed for the read byte/word command, the Transmit Slave Address and Device Command Registers are sent. Data is received into the DATA0 on the read byte, and the DATA0 and DATA1 registers on the read word. See section 5.5.5 of the *System Management Bus (SMBus) Specification, Version 2.0* for the format of the protocol.



Process Call

The process call is so named because a command sends data and waits for the slave to return a value dependent on that data. The protocol is simply a Write Word followed by a Read Word, but without a second command or stop condition.

When programmed for the Process Call command, the PCH transmits the Transmit Slave Address, Host Command, DATA0 and DATA1 registers. Data received from the device is stored in the DATA0 and DATA1 registers. The Process Call command with I2C_EN set and the PEC_EN bit set produces undefined results. Software must force either I2C_EN or PEC_EN to 0 when running this command. See section 5.5.6 of the *System Management Bus (SMBus) Specification, Version 2.0* for the format of the protocol.

Note: For process call command, the value written into bit 0 of the Transmit Slave Address Register (SMB I/O register, Offset 04h) needs to be 0.

Note: If the I2C_EN bit is set, the protocol sequence changes slightly: the Command Code (Bits 18:11 in the bit sequence) are not sent - as a result, the slave will not acknowledge (Bit 19 in the sequence).

Block Read/Write

The PCH contains a 32-byte buffer for read and write data which can be enabled by setting bit 1 of the Auxiliary Control register at offset 0Dh in I/O space, as opposed to a single byte of buffering. This 32-byte buffer is filled with write data before transmission, and filled with read data on reception. In the PCH, the interrupt is generated only after a transmission or reception of 32 bytes, or when the entire byte count has been transmitted/received.

Note: When operating in I²C mode (I2C_EN bit is set), the PCH will never use the 32-byte buffer for any block commands.

The byte count field is transmitted but ignored by the PCH as software will end the transfer after all bytes it cares about have been sent or received.

For a Block Write, software must either force the I2C_EN bit or both the PEC_EN and AAC bits to 0 when running this command.

The block write begins with a slave address and a write condition. After the command code the PCH issues a byte count describing how many more bytes will follow in the message. If a slave had 20 bytes to send, the first byte would be the number 20 (14h), followed by 20 bytes of data. The byte count may not be 0. A Block Read or Write is allowed to transfer a maximum of 32 data bytes.

When programmed for a block write command, the Transmit Slave Address, Device Command, and Data0 (count) registers are sent. Data is then sent from the Block Data Byte register; the total data sent being the value stored in the Data0 Register. On block read commands, the first byte received is stored in the Data0 register, and the remaining bytes are stored in the Block Data Byte register. See section 5.5.7 of the *System Management Bus (SMBus) Specification, Version 2.0* for the format of the protocol.

Note: For Block Write, if the I2C_EN bit is set, the format of the command changes slightly. The PCH will still send the number of bytes (on writes) or receive the number of bytes (on reads) indicated in the DATA0 register. However, it will not send the contents of the DATA0 register as part of the message. Also, the Block Write protocol sequence changes slightly: the Byte Count (bits 27:20 in the bit sequence) are not sent - as a result, the slave will not acknowledge (bit 28 in the sequence).

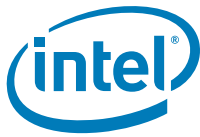

I²C Read

This command allows the PCH to perform block reads to certain I²C devices, such as serial E²PROMs. The SMBus Block Read supports the 7-bit addressing mode only.

However, this does not allow access to devices using the I²C “Combined Format” that has data bytes after the address. Typically these data bytes correspond to an offset (address) within the serial memory chips.

Note: This command is supported independent of the setting of the I2C_EN bit. The I²C Read command with the PEC_EN bit set produces undefined results. Software must force both the PEC_EN and AAC bit to 0 when running this command.

For I²C Read command, the value written into bit 0 of the Transmit Slave Address Register (SMB I/O register, offset 04h) needs to be 0.

The format that is used for the command is shown in [Table 5-43](#).

Table 5-43. I²C Block Read

Bit	Description
1	Start
8:2	Slave Address – 7 bits
9	Write
10	Acknowledge from slave
18:11	Send DATA1 register
19	Acknowledge from slave
20	Repeated Start
27:21	Slave Address – 7 bits
28	Read
29	Acknowledge from slave
37:30	Data byte 1 from slave – 8 bits
38	Acknowledge
46:39	Data byte 2 from slave – 8 bits
47	Acknowledge
–	Data bytes from slave / Acknowledge
–	Data byte N from slave – 8 bits
–	NOT Acknowledge
–	Stop

The PCH will continue reading data from the peripheral until the NAK is received.



Block Write–Block Read Process Call

The block write-block read process call is a two-part message. The call begins with a slave address and a write condition. After the command code the host issues a write byte count (M) that describes how many more bytes will be written in the first part of the message. If a master has 6 bytes to send, the byte count field will have the value 6 (0000 0110b), followed by the 6 bytes of data. The write byte count (M) cannot be 0.

The second part of the message is a block of read data beginning with a repeated start condition followed by the slave address and a Read bit. The next byte is the read byte count (N), which may differ from the write byte count (M). The read byte count (N) cannot be 0.

The combined data payload must not exceed 32 bytes. The byte length restrictions of this process call are summarized as follows:

- $M \geq 1$ byte
- $N \geq 1$ byte
- $M + N \leq 32$ bytes

The read byte count does not include the PEC byte. The PEC is computed on the total message beginning with the first slave address and using the normal PEC computational rules. It is highly recommended that a PEC byte be used with the Block Write-Block Read Process Call. Software must do a read to the command register (offset 2h) to reset the 32 byte buffer pointer prior to reading the block data register.

Note that there is no STOP condition before the repeated START condition, and that a NACK signifies the end of the read transfer.

Note: E32B bit in the Auxiliary Control register must be set when using this protocol.

See section 5.5.8 of the *System Management Bus (SMBus) Specification, Version 2.0* for the format of the protocol.

5.20.2 Bus Arbitration

Several masters may attempt to get on the bus at the same time by driving the SMBDATA line low to signal a start condition. The PCH continuously monitors the SMBDATA line. When the PCH is attempting to drive the bus to a 1 by letting go of the SMBDATA line, and it samples SMBDATA low, then some other master is driving the bus and the PCH will stop transferring data.

If the PCH sees that it has lost arbitration, the condition is called a collision. The PCH will set the BUS_ERR bit in the Host Status Register, and if enabled, generate an interrupt or SMI#. The processor is responsible for restarting the transaction.

When the PCH is a SMBus master, it drives the clock. When the PCH is sending address or command as an SMBus master, or data bytes as a master on writes, it drives data relative to the clock it is also driving. It will not start toggling the clock until the start or stop condition meets proper setup and hold time. The PCH will also ensure minimum time between SMBus transactions as a master.

Note: The PCH supports the same arbitration protocol for both the SMBus and the System Management (SMLink) interfaces.

5.20.3 Bus Timing

5.20.3.1 Clock Stretching

Some devices may not be able to handle their clock toggling at the rate that the PCH as an SMBus master would like. They have the capability of stretching the low time of the clock. When the PCH attempts to release the clock (allowing the clock to go high), the clock will remain low for an extended period of time.

The PCH monitors the SMBus clock line after it releases the bus to determine whether to enable the counter for the high time of the clock. While the bus is still low, the high time counter must not be enabled. Similarly, the low period of the clock can be stretched by an SMBus master if it is not ready to send or receive data.

5.20.3.2 Bus Time Out (The PCH as SMBus Master)

If there is an error in the transaction, such that an SMBus device does not signal an acknowledge, or holds the clock lower than the allowed time-out time, the transaction will time out. The PCH will discard the cycle and set the DEV_ERR bit. The time out minimum is 25 ms (800 RTC clocks). The time-out counter inside the PCH will start after the last bit of data is transferred by the PCH and it is waiting for a response.

The 25-ms time-out counter will not count under the following conditions:

1. BYTE_DONE_STATUS bit (SMBus I/O Offset 00h, Bit 7) is set
2. The SECOND_TO_STS bit (TCO I/O Offset 06h, Bit 1) is not set (this indicates that the system has not locked up).

5.20.4 Interrupts / SMI#

The PCH SMBus controller uses PIRQB# as its interrupt pin. However, the system can alternatively be set up to generate SMI# instead of an interrupt, by setting the SMBUS_SMI_EN bit (Device 31:Function 0:Offset 40h:Bit 1).

Table 5-45 and Table 5-46 specify how the various enable bits in the SMBus function control the generation of the interrupt, Host and Slave SMI, and Wake internal signals. The rows in the tables are additive, which means that if more than one row is true for a particular scenario then the Results for all of the activated rows will occur.

Table 5-44. Enable for SMBALERT#

Event	INTREN (Host Control I/O Register, Offset 02h, Bit 0)	SMB_SMI_EN (Host Configuration Register, D31:F3:Offset 40h, Bit 1)	SMBALERT_DIS (Slave Command I/O Register, Offset 11h, Bit 2)	Result
SMBALERT# asserted low (always reported in Host Status Register, Bit 5)	X	X	X	Wake generated
	X	1	0	Slave SMI# generated (SMBUS_SMI_STS)
	1	0	0	Interrupt generated

**Table 5-45. Enables for SMBus Slave Write and SMBus Host Events**

Event	INTREN (Host Control I/O Register, Offset 02h, Bit 0)	SMB_SMI_EN (Host Configuration Register, D31:F3:Offset 40h, Bit 1)	Event
Slave Write to Wake/SMI# Command	X	X	Wake generated when asleep. Slave SMI# generated when awake (SMBUS_SMI_STS).
Slave Write to SMLINK_SLAVE_SMI Command	X	X	Slave SMI# generated when in the S0 state (SMBUS_SMI_STS)
Any combination of Host Status Register [4:1] asserted	0	X	None
	1	0	Interrupt generated
	1	1	Host SMI# generated

Table 5-46. Enables for the Host Notify Command

HOST_NOTIFY_INTREN (Slave Control I/O Register, Offset 11h, Bit 0)	SMB_SMI_EN (Host Config Register, D31:F3:Off40h, Bit 1)	HOST_NOTIFY_WKEN (Slave Control I/O Register, Offset 11h, Bit 1)	Result
0	X	0	None
X	X	1	Wake generated
1	0	X	Interrupt generated
1	1	X	Slave SMI# generated (SMBUS_SMI_STS)

5.20.5 SMBALERT#

SMBALERT# is multiplexed with GPIO[11]. When enable and the signal is asserted, the PCH can generate an interrupt, an SMI#, or a wake event from S1–S5.

5.20.6 SMBus CRC Generation and Checking

If the AAC bit is set in the Auxiliary Control register, the PCH automatically calculates and drives CRC at the end of the transmitted packet for write cycles, and will check the CRC for read cycles. It will not transmit the contents of the PEC register for CRC. The PEC bit must not be set in the Host Control register if this bit is set, or unspecified behavior will result.

If the read cycle results in a CRC error, the DEV_ERR bit and the CRCE bit in the Auxiliary Status register at Offset 0Ch will be set.



5.20.7 SMBus Slave Interface

The PCH SMBus Slave interface is accessed using the SMBus. The SMBus slave logic will not generate or handle receiving the PEC byte and will only act as a Legacy Alerting Protocol device. The slave interface allows the PCH to decode cycles, and allows an external microcontroller to perform specific actions. Key features and capabilities include:

- Supports decode of three types of messages: Byte Write, Byte Read, and Host Notify.
- Receive Slave Address register: This is the address that the PCH decodes. A default value is provided so that the slave interface can be used without the processor having to program this register.
- Receive Slave Data register in the SMBus I/O space that includes the data written by the external microcontroller.
- Registers that the external microcontroller can read to get the state of the PCH.
- Status bits to indicate that the SMBus slave logic caused an interrupt or SMI# due to the reception of a message that matched the slave address.
 - Bit 0 of the Slave Status Register for the Host Notify command
 - Bit 16 of the SMI Status Register ([Section 13.8.3.8](#)) for all others

Note: The external microcontroller should not attempt to access the PCH SMBus slave logic until either:

- 800 milliseconds after both: RTCRST# is high and RSMRST# is high, OR
- The PLTRST# deasserts

If a master leaves the clock and data bits of the SMBus interface at 1 for 50 μ s or more in the middle of a cycle, the PCH slave logic's behavior is undefined. This is interpreted as an unexpected idle and should be avoided when performing management activities to the slave logic.

Note: When an external microcontroller accesses the SMBus Slave Interface over the SMBus a translation in the address is needed to accommodate the least significant bit used for read/write control. For example, if the PCH slave address (RCV_SLVA) is left at 44h (default), the external micro controller would use an address of 88h/89h (write/read).



5.20.7.1 Format of Slave Write Cycle

The external master performs Byte Write commands to the PCH SMBus Slave I/F. The “Command” field (bits 11:18) indicate which register is being accessed. The Data field (bits 20:27) indicate the value that should be written to that register.

Table 5-47 has the values associated with the registers.

Table 5-47. Slave Write Registers

Register	Function
0	Command Register. See Table 5-48 for legal values written to this register.
1–3	Reserved
4	Data Message Byte 0
5	Data Message Byte 1
6–7	Reserved
8	Reserved
9–FFh	Reserved

NOTE: The external microcontroller is responsible to make sure that it does not update the contents of the data byte registers until they have been read by the system processor. The PCH overwrites the old value with any new value received. A race condition is possible where the new value is being written to the register just at the time it is being read. The PCH will not attempt to cover this race condition (that is, unpredictable results in this case).

Table 5-48. Command Types (Sheet 1 of 2)

Command Type	Description
0	Reserved
1	WAKE/SMI#. This command wakes the system if it is not already awake. If system is already awake, an SMI# is generated. NOTE: The SMB_WAK_STS bit will be set by this command, even if the system is already awake. The SMI handler should then clear this bit.
2	Unconditional Powerdown. This command sets the PWRBTNOR_STS bit, and has the same effect as the Powerbutton Override occurring.
3	HARD RESET WITHOUT CYCLING: This command causes a hard reset of the system (does not include cycling of the power supply). This is equivalent to a write to the CF9h register with Bits 2:1 set to 1, but Bit 3 set to 0.
4	HARD RESET SYSTEM. This command causes a hard reset of the system (including cycling of the power supply). This is equivalent to a write to the CF9h register with Bits 3:1 set to 1.
5	Disable the TCO Messages. This command will disable the PCH from sending Heartbeat and Event messages (as described in Section 5.14). Once this command has been executed, Heartbeat and Event message reporting can only be re-enabled by assertion and deassertion of the RSMRST# signal.
6	WD RELOAD: Reload watchdog timer.
7	Reserved

Table 5-48. Command Types (Sheet 2 of 2)

Command Type	Description
8	<p>SMLINK_SLV_SMI. When the PCH detects this command type while in the S0 state, it sets the SMLINK_SLV_SMI_STS bit (see Section 13.9.5). This command should only be used if the system is in an S0 state. If the message is received during S1–S5 states, the PCH acknowledges it, but the SMLINK_SLV_SMI_STS bit does not get set.</p> <p>NOTE: It is possible that the system transitions out of the S0 state at the same time that the SMLINK_SLV_SMI command is received. In this case, the SMLINK_SLV_SMI_STS bit may get set but not serviced before the system goes to sleep. Once the system returns to S0, the SMI associated with this bit would then be generated. Software must be able to handle this scenario.</p>
9–FFh	Reserved.

5.20.7.2 Format of Read Command

The external master performs Byte Read commands to the PCH SMBus Slave interface. The “Command” field (bits 18:11) indicate which register is being accessed. The Data field (bits 30:37) contain the value that should be read from that register.

Table 5-49. Slave Read Cycle Format

Bit	Description	Driven by	Comment
1	Start	External Microcontroller	
2-8	Slave Address - 7 bits	External Microcontroller	Must match value in Receive Slave Address register
9	Write	External Microcontroller	Always 0
10	ACK	PCH	
11-18	Command code - 8 bits	External Microcontroller	Indicates which register is being accessed. See Table 5-50 for a list of implemented registers.
19	ACK	PCH	
20	Repeated Start	External Microcontroller	
21-27	Slave Address - 7 bits	External Microcontroller	Must match value in Receive Slave Address register
28	Read	External Microcontroller	Always 1
29	ACK	PCH	
30-37	Data Byte	PCH	Value depends on register being accessed. See Table 5-50 for a list of implemented registers.
38	NOT ACK	External Microcontroller	
39	Stop	External Microcontroller	



Table 5-50. Data Values for Slave Read Registers (Sheet 1 of 2)

Register	Bits	Description
0	7:0	Reserved for capabilities indication. Should always return 00h. Future chips may return another value to indicate different capabilities.
1	2:0	System Power State 000 = S0 001 = S1 010 = Reserved 011 = S3 100 = S4 101 = S5 110 = Reserved 111 = Reserved
	7:3	Reserved
2	3:0	Reserved
	7:4	Reserved
3	5:0	Watchdog Timer current value Note that Watchdog Timer has 10 bits, but this field is only 6 bits. If the current value is greater than 3Fh, the PCH will always report 3Fh in this field.
	7:6	Reserved
4	0	1 = The Intruder Detect (INTRD_DET) bit is set. This indicates that the system cover has probably been opened.
	1	1 = BTI Temperature Event occurred. This bit will be set if the PCH's THRM# input signal is active. Else this bit will read "0."
	2	DOA Processor Status. This bit will be 1 to indicate that the processor is dead
	3	1 = SECOND_TO_STS bit set. This bit will be set after the second time-out (SECOND_TO_STS bit) of the Watchdog Timer occurs.
	6:4	Reserved. Will always be 0, but software should ignore.
	7	Reflects the value of the GPIO[11]/SMBALERT# pin (and is dependent upon the value of the GPI_INV[11] bit. If the GPI_INV[11] bit is 1, then the value in this bit equals the level of the GPI[11]/SMBALERT# pin (high = 1, low = 0). If the GPI_INV[11] bit is 0, then the value of this bit will equal the inverse of the level of the GPIO[11]/SMBALERT# pin (high = 0, low = 1).
5	0	FWH bad bit. This bit will be 1 to indicate that the FWH read returned FFh, which indicates that it is probably blank.
	1	Reserved
	2	SYS_PWROK Failure Status: This bit will be 1 if the SYSPWR_FLR bit in the GEN_PMCN_2 register is set.
	3	INIT3_3V# due to receiving Shutdown message: This event is visible from the reception of the shutdown message until a platform reset is done if the Shutdown Policy Select bit (SPS) is configured to drive INIT3_3V#. When the SPS bit is configured to generate PLTRST# based on shutdown, this register bit will always return 0. Events on signal will not create an event message
	4	Reserved
	5	POWER_OK_BAD: Indicates the failure core power well ramp during boot/resume. This bit will be active if the SLP_S3# pin is deasserted and PWROK pin is not asserted.
	6	Thermal Trip: This bit will shadow the state of processor Thermal Trip status bit (CTS) (16.2.1.2, GEN_PMCN_2, bit 3). Events on signal will not create an event message
	7	Reserved: Default value is "X" NOTE: Software should not expect a consistent value when this bit is read through SMBUS/SMLink

Table 5-50. Data Values for Slave Read Registers (Sheet 2 of 2)

Register	Bits	Description
6	7:0	Contents of the Message 1 register. Refer to Section 13.9.8 for the description of this register.
7	7:0	Contents of the Message 2 register. Refer to Section 13.9.8 for the description of this register.
8	7:0	Contents of the TCO_WDCNT register. Refer to Section 13.9.9 for the description of this register.
9	7:0	Seconds of the RTC
A	7:0	Minutes of the RTC
B	7:0	Hours of the RTC
C	7:0	"Day of Week" of the RTC
D	7:0	"Day of Month" of the RTC
E	7:0	Month of the RTC
F	7:0	Year of the RTC
10h–FFh	7:0	Reserved

5.20.7.2.1 Behavioral Notes

According to SMBus protocol, Read and Write messages always begin with a Start bit – Address– Write bit sequence. When the PCH detects that the address matches the value in the Receive Slave Address register, it will assume that the protocol is always followed and ignore the Write bit (Bit 9) and signal an Acknowledge during bit 10. In other words, if a Start –Address–Read occurs (which is illegal for SMBus Read or Write protocol), and the address matches the PCH’s Slave Address, the PCH will still grab the cycle.

Also according to SMBus protocol, a Read cycle contains a Repeated Start–Address–Read sequence beginning at Bit 20. Once again, if the Address matches the PCH’s Receive Slave Address, it will assume that the protocol is followed, ignore bit 28, and proceed with the Slave Read cycle.

Note: An external microcontroller must not attempt to access the PCH’s SMBus Slave logic until at least 1 second after both RTCRST# and RSMRST# are deasserted (high).

5.20.7.3 Slave Read of RTC Time Bytes

The PCH SMBus slave interface allows external SMBus master to read the internal RTC’s time byte registers.

The RTC time bytes are internally latched by the PCH’s hardware whenever RTC time is not changing and SMBus is idle. This ensures that the time byte delivered to the slave read is always valid and it does not change when the read is still in progress on the bus. The RTC time will change whenever hardware update is in progress, or there is a software write to the RTC time bytes.

The PCH SMBus slave interface only supports Byte Read operation. The external SMBus master will read the RTC time bytes one after another. It is software’s responsibility to check and manage the possible time rollover when subsequent time bytes are read.



For example, assuming the RTC time is 11 hours: 59 minutes: 59 seconds. When the external SMBus master reads the hour as 11, then proceeds to read the minute, it is possible that the rollover happens between the reads and the minute is read as 0. This results in 11 hours: 0 minute instead of the correct time of 12 hours: 0 minutes. Unless it is certain that rollover will not occur, software is required to detect the possible time rollover by reading multiple times such that the read time bytes can be adjusted accordingly if needed.

5.20.7.4 Format of Host Notify Command

The PCH tracks and responds to the standard Host Notify command as specified in the *System Management Bus (SMBus) Specification, Version 2.0*. The host address for this command is fixed to 0001000b. If the PCH already has data for a previously-received host notify command which has not been serviced yet by the host software (as indicated by the HOST_NOTIFY_STS bit), then it will NACK following the host address byte of the protocol. This allows the host to communicate non-acceptance to the master and retain the host notify address and data values for the previous cycle until host software completely services the interrupt.

Note: Host software must always clear the HOST_NOTIFY_STS bit after completing any necessary reads of the address and data registers.

Table 5-51 shows the Host Notify format.

Table 5-51. Host Notify Format

Bit	Description	Driven By	Comment
1	Start	External Master	
8:2	SMB Host Address – 7 bits	External Master	Always 0001_000
9	Write	External Master	Always 0
10	ACK (or NACK)	PCH	PCH NACKs if HOST_NOTIFY_STS is 1
17:11	Device Address – 7 bits	External Master	Indicates the address of the master; loaded into the Notify Device Address Register
18	Unused – Always 0	External Master	7-bit-only address; this bit is inserted to complete the byte
19	ACK	PCH	
27:20	Data Byte Low – 8 bits	External Master	Loaded into the Notify Data Low Byte Register
28	ACK	PCH	
36:29	Data Byte High – 8 bits	External Master	Loaded into the Notify Data High Byte Register
37	ACK	PCH	
38	Stop	External Master	

5.21 Thermal Management

5.21.1 Thermal Sensor

The PCH incorporates one on-die Digital thermal sensor (DTS) for thermal management. The thermal sensor can provide PCH temperature information to an EC or SIO device that can be used to determine how to control the fans.

This thermal sensor is located near the DMI interface. The on-die thermal sensor is placed as close as possible to the hottest on-die location to reduce thermal gradients and to reduce the error on the sensor trip thresholds. The thermal Sensor trip points may be programmed to generate various interrupts including SCI, SMI, PCI and other General Purpose events.

5.21.1.1 Internal Thermal Sensor Operation

The internal thermal sensor reports four trip points: Aux2, Aux, Hot and Catastrophic trip points in the order of increasing temperature.

Aux, Aux2 Temperature Trip Points

These trip points may be set dynamically if desired and provides an interrupt to ACPI (or other software) when it is crossed in either direction. These auxiliary temperature trip points do not automatically cause any hardware throttling but may be used by software to trigger interrupts. This trip point is set below the Hot temperature trip point and responses are separately programmable from the hot temperature settings, in order to provide incrementally more aggressive actions. Aux and Aux2 trip points are fully Software programmable during system run-time. Aux2 trip point is set below the Aux temperature trip point.

Hot Temperature Trip Point

This trip point may be set dynamically if desired and provides an interrupt to ACPI (or other software) when it is crossed in either direction. Software could optionally set this as an Interrupt when the temperature exceeds this level setting. Hot trip does not provide any default hardware based thermal throttling, and is available only as a customer configurable interrupt when $T_{j,max}$ has been reached.

Catastrophic Trip Point

This trip point is set at the temperature at which the PCH must be shut down immediately without any software support. The catastrophic trip point must correspond to a temperature ensured to be functional in order for the interrupt generation and Hardware response. Hardware response using THERMTRIP# would be an unconditional transition to S5. The catastrophic transition to the S5 state does not enforce a minimum time in the S5 state. It is assumed that the S5 residence and the reboot sequence cools down the system. If the catastrophic condition remains when the catastrophic power down enable bit is set by BIOS, then the system will re-enter S5.

Thermometer Mode

The thermometer is implemented using a counter that starts at 0 and increments during each sample point until the comparator indicates the temperature is above the current value. The value of the counter is loaded into a read-only register (Thermal Sensor Thermometer Read) when the comparator first trips.



5.21.1.1.1 Recommended Programming for Available Trip Points

There may be a ± 2 °C offset due to thermal gradient between the hot-spot and the location of the thermal sensor. Trip points should be programmed to account for this temperature offset between the hot-spot $T_{j,max}$ and the thermal sensor.

Aux Trip Points should be programmed for software and firmware control using interrupts.

Hot Trip Point should be set to throttle at 108 °C ($T_{j,max}$) due to DTS trim accuracy adjustments. Hot trip points should also be programmed for a software response.

Catastrophic Trip Point should be set to halt operation to avoid maximum T_j of about 120 °C.

Note: Crossing a trip point in either direction may generate several types of interrupts. Each trip point has a register that can be programmed to select the type of interrupt to be generated. Crossing a trip point is implemented as edge detection on each trip point to generate the interrupts.

5.21.1.1.2 Thermal Sensor Accuracy ($T_{accuracy}$)

$T_{accuracy}$ for the PCH is ± 5 °C in the temperature range 90 °C to 120 °C. $T_{accuracy}$ is ± 10 °C for temperatures from 45 °C – 90 °C. The PCH may not operate above +108 °C. This value is based on product characterization and is not ensured by manufacturing test.

Software has the ability to program the T_{cat} , T_{hot} , and T_{aux} trip points, but these trip points should be selected with consideration for the thermal sensor accuracy and the quality of the platform thermal solution. Overly conservative (unnecessarily low) temperature settings may unnecessarily degrade performance due to frequent throttling, while overly aggressive (dangerously high) temperature settings may fail to protect the part against permanent thermal damage.

5.21.2 PCH Thermal Throttling

Occasionally the PCH may operate in conditions that exceed its maximum operating temperature. In order to protect itself and the system from thermal failure, the PCH is capable of reducing its overall power consumption and as a result, lower its temperature. This is achieved by:

- Forcing the SATA device and interface in to a lower power state
- Reducing the number of active lanes on the DMI interface
- Reducing the Intel Manageability Engine (Intel ME) clock frequency

The severity of the throttling response is defined by four global PCH throttling states referred to as T-states. In each T-state, the throttling response will differ per interface, but will operate concurrently when a global T-state is activated. A T-state corresponds to a temperature range. The T-states are defined in [Table 5-52](#).

Table 5-52. PCH Thermal Throttle States (T-states)

State	Description
T0	Normal operation, temperature is less than the T1 trip point temperature
T1	Temperature is greater than or equal to the T1 trip point temperature, but less than the T2 trip point temperature. The default temperature is $T_{j,max}$ at 108 °C
T2	Temperature is greater than or equal to the T2 trip point temperature, but less than the T3 trip point temperature. The default temperature is 112 °C
T3	Temperature is greater than or equal to the T3 trip point temperature. The default temperature is 116 °C

Enabling of this feature requires appropriate Intel Manageability Engine firmware and configuration of the following registers shown in [Table 5-53](#).

Table 5-53. PCH Thermal Throttling Configuration Registers

Register Name	Register Location	
TT – Thermal Throttling	TBARB+6Ch	Section 22.2.15

5.21.3 Thermal Reporting Over System Management Link 1 Interface (SMLink1)

SMLink1 interface in the PCH is the SMBus link to an optional external controller. A SMBus protocol is defined on the PCH to allow compatible devices such as Embedded Controller (EC) or SIO to obtain system thermal data from sensors integrated into components on the system using the SMLink1 interface. The sensors that can be monitored using the SMLink1 include those in the processor, PCH and DIMMs with sensors implemented. This solution allows an external device or controller to use the system thermal data for system thermal management.

Note: To enable Thermal Reporting, the Thermal Data Reporting enable and PCH/DIMM temperature read enables have to be set in the Thermal Reporting Control (TRC) Register (See [Section 22.2](#) for details on Register)

There are two uses for the PCH's thermal reporting capability:

1. To provide system thermal data to an external controller. The controller can manage the fans and other cooling elements based on this data. In addition, the PCH can be programmed by setting appropriate bits in the Alert Enable (AE) Register (See [Section 22.2](#) for details on this register) to alert the controller when a device has gone outside of its temperature limits. The alert causes the assertion of the PCH TEMP_ALERT# (SATA5GP/GPIO49/TEMP_ALERT#) signal. See [Section 5.21.3.6](#) for more details.
2. To provide an interface between the external controller and host software. This software interface has no direct affect on the PCH's thermal collection. It is strictly a software interface to pass information or data.

The PCH responds to thermal requests only when the system is in S0 or S1. Once the PCH has been programmed, it will start responding to a request while the system is in S0 or S1.



To implement this thermal reporting capability, the platform is required to have appropriate Intel ME firmware, BIOS support, and compatible devices that support the SMBus protocol.

5.21.3.1 Supported Addresses

The PCH supports 2 addresses: I²C Address for writes and Block Read Address for reads. These addresses need to be distinct.

The two addresses may be fixed by the external controller, or programmable within the controller. The addresses used by the PCH are completely programmable.

5.21.3.1.1 I²C Address

This address is used for writes to the PCH.

- The address is set by soft straps which are values stored in SPI flash and are defined by the OEM. The address can be set to any value the platform requires.
- This address supports all the writes listed in [Table 5-54](#).
- SMBus reads by the external controller to this address are not allowed and result in indeterminate behavior.

5.21.3.1.2 Block Read Address

This address is used for reads from the PCH.

- The address is set by soft straps or BIOS. It can be set to any value the platform requires.
- This address only supports SMBus Block Read command and not Byte or Word Read.
- The Block Read command is supported as defined in the SMBus 2.0 specification, with the command being 40h, and the byte count being provided by the PCH following the block read format in the SMBus specification.
- Writes are not allowed to this address, and result in indeterminate behavior.
- Packet Error Code (PEC) may be enabled or not, which is set up by BIOS.



5.21.3.2 I²C Write Commands to the Intel® ME

Table 5-54 lists the write commands supported by the Intel ME.

All bits in the write commands must be written to the PCH or the operation will be aborted. For example, for 6-bytes write commands, all 48 bits must be written or the operation will be aborted.

The command format follows the Block Write format of the SMBus specification.

Table 5-54. I²C Write Commands to the Intel® ME

Transaction	Slave Addr	Data Byte0 (Command)	Data Byte 1 (Byte Count)	Data Byte 2	Data Byte 3	Data Byte 4	Data Byte 5	Data Byte 6	Data Byte 7
Write Processor Temp Limits	I ² C	42h	4h	Lower Limit [15:8]	Lower Limit [7:0]	Upper Limit [15:8]	Upper Limit [7:0]		
Write PCH Temp Limits	I ² C	44h	2h	Lower Limit [7:0]	Upper Limit [7:0]				
Write DIMM Temp Limits	I ² C	45h	2h	Lower Limit [7:0]	Upper Limit [7:0]				

5.21.3.3 Block Read Command

The external controller may read thermal information from the PCH using the SMBus Block Read Command. Byte-read and Word-read SMBus commands are not supported. Note that the reads use a different address than the writes.

The command format follows the Block Read format of the SMBus specification.

The PCH and external controller are set up by BIOS with the length of the read that is supported by the platform. The device must always do reads of the lengths set up by BIOS.

The PCH supports any one of the following lengths: 2, 4, 5, 9, 10, 14 or 20 bytes. The data always comes in the order described in Table 5-54, where 0 is the first byte received in time on the SMBus.



Table 5-55. Block Read Command – Byte Definition

Byte	Definition
Byte 0	Processor Package temperature, in absolute degrees Celsius (C). This is not relative to some max or limit, but is the maximum in absolute degrees. If the processor temperature collection has errors, this field will be FFh. Read value represents bits [7:0] of PTV (Processor Temperature Value)
Byte 1	The PCH temp in degrees C. FFh indicates error condition. Read value represents bits [7:0] of ITV (Internal Temperature Values) Register described in Section 22.2 . NOTE: Requires TRC (Thermal Reporting Control) Register bit [5] to be enabled. See Section 22.2 .
Byte 3:2	Reserved
Byte 4	Reserved
Byte 5	Thermal Sensor (TS) on DIMM 0 If DIMM not populated, or if there is no TS on DIMM, value will be 0h Read value represents bits[7:0] of DTV (DIMM Temperature Values) Register described in Section 22.2 . NOTE: Requires TRC (Thermal Reporting Control) Register bit [0] to be enabled. See Section 22.2 .
Byte 6	Thermal Sensor (TS) on DIMM 1 If DIMM not populated, or if there is no TS on DIMM, value will be 0h Read value represents bits[15:8] of DTV (DIMM Temperature Values) Register described in Section 22.2 . NOTE: Requires TRC (Thermal Reporting Control) Register bit [1] to be enabled. See Section 22.2 .
Byte 7	Thermal Sensor (TS) on DIMM 2 If DIMM not populated, or if there is no TS on DIMM, value will be 0h. Read value represents bits[23:16] of DTV (DIMM Temperature Values) Register described in Section 22.2 . NOTE: Requires TRC (Thermal Reporting Control) Register bit [2] to be enabled. See Section 22.2 .
Byte 8	Thermal Sensor (TS) on DIMM 3 If DIMM not populated, or if there is no TS on DIMM, value will be 0h. Read value represents bits[31:24] of DTV (DIMM Temperature Values) Register described in Section 22.2 . NOTE: Requires TRC (Thermal Reporting Control) Register bit [3] to be enabled.
Byte 9	Sequence number. Can be used to check if the PCH's FW or HW is hung. See Section 5.21.3.9 for usage. This byte is updated every time the collected data is updated Read value represents bits[23:16] of ITV (Internal Temperature Values) Register described in Section 22.2 .
Byte 19:10	Reserved

A 2-byte read would provide both the PCH and processor temperature. A device that wants DIMM information would read 9 bytes.

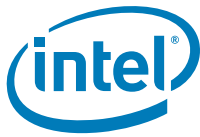

5.21.3.4 Read Data Format

For each of the data fields an ERROR Code is listed below. This code indicates that the PCH failed in its access to the device. This would be for the case where the read returned no data, or some illegal value. In general that would mean the device is broken. The EC can treat the device that failed the read as broken or with some fail-safe mechanism.

5.21.3.4.1 PCH and DIMM Temperature

The temperature readings for the PCH, DIMM are 8-bit unsigned values from 0–255. The minimum granularity supported by the internal thermal sensor is 1 °C. Thus, there are no fractional values for the PCH or DIMM temperatures.

Note the sensors used within the components do not support values below 0 degrees, so this field is treated as 8 bits (0–255) absolute and not 2's complement (-128 to 127).

Devices that are not present or that are disabled will be set to 0h. Devices that have a failed reading (that is, the read from the device did not return any legal value) will be set to FFh. A failed reading means that the attempt to read that device returned a failure. The failure could have been from a bus failure or that the device itself had an internal failure. For instance, a system may only have one DIMM and it would report only that one value, and the values for the other DIMMs would all be 00h.

5.21.3.5 Thermal Data Update Rate

The temperature values are updated every 200 ms in the PCH, so reading more often than that simply returns the same data multiple times. Also, the data may be up to 200 ms old if the external controller reads the data right before the next update window.

5.21.3.6 Temperature Comparator and Alert

The PCH has the ability to alert the external controller when temperatures are out of range. This is done using the PCH TEMP_ALERT# signal. The alert is a simple comparator. If any device's temperature is outside the limit range for that device, then the signal is asserted (electrical low). Note that this alert does not use the SML1ALERT#.

The PCH supports 4 ranges:

1. PCH range - upper and lower limit (8 bits each, in degrees C) for the PCH temperature.
2. DIMM range - upper and lower limit (8 bits each, in degrees C), applies to all DIMMs (up to 4 supported) that are enabled. Disabled (unpopulated) DIMMs do not participate in the thermal compares.
3. Processor Package range - upper and lower limit (8 bits each, in degrees C)

The comparator checks if the device is within the specified range, including the limits. For example, a device that is at 100 degrees when the upper limit is 100 will not trigger the alert. Likewise, a device that is at 70 degrees when the lower limit is 70 will not trigger the alert.

The compares are done only on devices that have been enabled by BIOS for checking. Since BIOS knows how many DIMMs are in the system, it enables the checking only for those devices that are physically present.

The compares are done in firmware, so all the compares are executed in one software loop and at the end, if there is any out of bound temperature, the PCH's TEMP_ALERT# signal is asserted.



When the external controller sees the TEMP_ALERT# signal low, it knows some device is out of range. It can read the temperatures and then change the limits for the devices. Note that it may take up to 250 ms before the actual writes cause the signal to change state. For instance if the PCH is at 105 degrees and the limit is 100, the alert is triggered. If the controller changes the limits to 110, the TEMP_ALERT# signal may remain low until the next thermal sampling window (every 200 ms) occurs and only then go high, assuming the PCH was still within its limits.

At boot, the controller can monitor the TEMP_ALERT# signal state. When BIOS has finished all the initialization and enabled the temperature comparators, the TEMP_ALERT# signal will be asserted since the default state of the limit registers is 0h; hence, when the PCH first reads temperatures, they will be out of range. This is the positive indication that the external controller may now read thermal information and get valid data. If the TEMP_ALERT# signal is enabled and not asserted within 30 seconds after PLTRST#, the external controller should assume there is a fatal error and handle accordingly. In general the TEMP_ALERT# signal will assert within a 1–4 seconds, depending on the actual BIOS implementation and flow.

Note: The TEMP_ALERT# assertion is only valid when PLTRST# is deasserted. The controller should mask the state of this signal when PLTRST# is asserted. Since the controller may be powered even when the PCH and the rest of the platform are not, the signal may glitch as power is being asserted; thus, the controller should wait until PLTRST# has deasserted before monitoring the signal.

5.21.3.6.1 Special Conditions

The external controller should have a graceful means of handling the following:

1. TEMP_ALERT# asserts, and the controller reads PCH, but all temperature values are within limits.
In this case, the controller should assume that by the time the controller could read the data, it had changed and moved back within the limits.
2. External controller writes new values to temperature limits, but TEMP_ALERT# is still asserted after several hundred msecs. When read, the values are back within limits.
In this case, the controller should treat this as case where the temperature changed and caused TEMP_ALERT# assertion, and then changed again to be back within limits.
3. There is the case where the external controller writes an update to the limit register, while the PCH is collecting the thermal information and updating the thermal registers. The limit change will only take effect when the write completes and the Intel® ME can process this change. If the Intel® ME is already in the process of collecting data and doing the compares, then it will continue to use the old limits during this round of compares, and then use the new limits in the next compare window.
4. Each SMBus write to change the limits is an atomic operation, but is distinct in itself. Therefore the external controller could write PCH limit, and then write DIMM limit. In the middle of those 2 writes, the thermal collecting procedure could be called by the Intel® ME, so that the comparisons for the limits are done with the new PCH limits but the old DIMM limits.

Note: The limit writes are done when the SMBus write is complete; therefore, the limits are updated atomically with respect to the thermal updates and compares. There is never a case where the compares and the thermal update are interrupted in the middle by the write of new limits. The thermal updates and compares are done as one non-interruptible routine, and then the limit writes would change the limit value outside of that routine.



5.21.3.7 BIOS Set Up

In order for the PCH to properly report temperature and enable alerts, the BIOS must configure the PCH at boot or from suspend/resume state by writing the following information to the PCH MMIO space. This information is NOT configurable using the external controller.

- Enables for each of the possible thermal alerts (PCH and DIMM). Note that each DIMM is enabled individually.
- Enables for reading DIMM and PCH temperatures. Note that each can be enabled individually.
- SMBus address to use for each DIMM.

Setting up the temperature calculation equations.

5.21.3.8 SMBus Rules

The PCH may NACK an incoming SMBus transaction. In certain cases the PCH will NACK the address, and in other cases it will NACK the command depending on internal conditions (such as errors, busy conditions). Given that most of the cases are due to internal conditions, the external controller must alias a NACK of the command and a NACK of the address to the same behavior. The controller must not try to make any determination of the reason for the NACK, based on the type of NACK (command vs. address).

The PCH will NACK when it is enabled but busy. The external controller is required to retry up to 3 times when they are NACK'ed to determine if the FW is busy with a data update. When the data values are being updated by the Intel ME, it will force this NACK to occur so that the data is atomically updated to the external controller. In reality if there is a NACK because of the PCH being busy, in almost all cases the next read will succeed since the update internally takes very little time.

The only long delay where there can be a NACK is if the internal Intel ME engine is reset. This is due to some extreme error condition and is therefore rare. In this case the NACK may occur for up to 30 seconds. After that, the external controller must assume that the PCH will never return good data. Even in the best of cases, when this internal reset occurs, it will always be a second or 2 to re-enable responding.

5.21.3.8.1 During Block Read

On the Block Read, the PCH will respect the NACK and Stop indications from the external controller, but will consider this an error case. It will recover from this case and correctly handle the next SMBus request.

The PCH will honor STOP during the block read command and cease providing data. On the next Block Read, the data will start with byte 0 again. However, this is not a recommended usage except for 'emergency cases'. In general the external controller should read the entire length of data that was originally programmed.

5.21.3.8.2 Power On

On the Block Read, the PCH will respect the NACK and Stop indications from the external controller, but will consider this an error case. It will recover from this case and correctly handle the next SMBus request.

The PCH will honor STOP during the block read command and cease providing data. On the next Block Read, the data will start with byte 0 again. However, this is not a recommended usage except for 'emergency cases'. In general the external controller should read the entire length of data that was originally programmed.



5.21.3.9 Case for Considerations

Below are some corner cases and some possible actions that the external controller could take.

Note that a 1-byte sequence number is available to the data read by the external controller. Each time the PCH updates the thermal information it will increment the sequence number. The external controller can use this value as an indication that the thermal FW is actually operating. Note that the sequence number will roll over to 00h when it reaches FFh.

1. Power on:

The PCH will not respond to any SMBus activity (on SMLink1 interface) until it has loaded the thermal Firmware (FW), which in general would take 1–4 seconds. During this period, the PCH will NACK any SMBus transaction from the external controller.

The load should take 1-4 seconds, but the external controller should design for 30 seconds based on long delays for S4 resume which takes longer than normal power up. This would be an extreme case, but for larger memory footprints and non-optimized recovery times, 30 seconds is a safe number to use for the time-out.

Recover/Failsafe: if the PCH has not responded within 30 seconds, the external controller can assume that the system has had a major error and the external controller should ramp the fans to some reasonably high value.

The only recover from this is an internal reset on the PCH, which is not visible to the external controller. Therefore the external controller might choose to poll every 10-60 seconds (some fairly long period) hereafter to see if the PCH's thermal reporting has come alive.

2. The PCH Thermal FW hangs and requires an internal reset which is not visible to the external controller.

The PCH will NACK any SMBus transaction from the external controller. The PCH may not be able to respond for up to 30 seconds while the FW is being reset and reconfigured.

The external controller could choose to poll every 1-10 seconds to see if the thermal FW has been successfully reset and is now providing data.

General recovery for this case is about 1 second, but 30 seconds should be used by the external controller at the time-out.

Recovery/Failsafe: same as in case #1.

3. Fatal PCH error, causes a global reset of all components.

When there is a fatal PCH error, a global reset may occur, and then case #1 applies.

The external controller can observe, if desired, PLTRST# assertion as an indication of this event.

4. The PCH thermal FW fails or is hung, but no reset occurs

The sequence number will not be updated, so the external controller knows to go to failsafe after some number of reads (8 or so) return the same sequence number.

The external controller could choose to poll every 1-10 seconds to see if the thermal FW has been successfully reset and working again.

In the absence of other errors, the updates for the sequence number should never be longer than 400 ms, so the number of reads needed to indicate that there is a hang should be at around 2 seconds. But when there is an error, the sequence number may not get updated for seconds. In the case that the

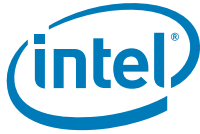

external controller sees a NACK from the PCH, then it should restart its sequence counter, or otherwise be aware that the NACK condition needs to be factored into the sequence number usage.

The use of sequence numbers is not required, but is provided as a means to ensure correct PCH FW operation.

5. When the PCH updates the Block Read data structure, the external controller gets a NACK during this period.

To ensure atomicity of the SMBus data read with respect to the data itself, when the data buffer is being updated, the PCH will NACK the Block Read transaction.

The update is only a few micro-seconds, so very short in terms of SMBus polling time; therefore, the next read should be successful. The external controller should attempt 3 reads to handle this condition before moving on.

If the Block read has started (that is, the address is ACK'ed) then the entire read will complete successfully, and the PCH will update the data only after the SMBus read has completed.

6. System is going from S0 to S3/4/5. Note that the thermal monitoring FW is fully operational if the system is in S0/S1, so the following only applies to S3/4/5.

When the PCH detects the OS request to go to S3/4/5, it will take the SMLink1 controller offline as part of the system preparation. The external controller will see a period where its transactions are getting NACK'ed, and then see SLP_S3# assert.

This period is relatively short (a couple of seconds depending on how long all the devices take to place themselves into the D3 state), and would be far less than the 30 second limit mentioned above.

7. TEMP_ALERT# – Since there can be an internal reset, the TEMP_ALERT# may get asserted after the reset. The external controller must accept this assertion and handle it.

5.21.3.9.1 Example Algorithm for Handling Transaction

One algorithm for the transaction handling could be summarized as follows. This is just an example to illustrate the above rules. There could be other algorithms that can achieve the same results.

1. Perform SMBus transaction.
2. If ACK, then continue
3. If NACK
 - a. Try again for 2 more times, in case the PCH is busy updating data.
 - b. If 3 successive transactions receive NACK, then
 - Ramp fans, assuming some general long reset or failure
 - Try every 1-10 seconds to see if SMBus transactions are now working
 - If they start then return to step 1
 - If they continue to fail, then stay in this step and poll, but keep the fans ramped up or implement some other failure recovery mechanism.



5.22 Intel® High Definition Audio Overview (D27:F0)

The PCH High Definition Audio (HDA) controller communicates with the external codec(s) over the Intel High Definition Audio serial link. The controller consists of a set of DMA engines that are used to move samples of digitally encoded data between system memory and an external codec(s). The PCH implements four output DMA engines and 4 input DMA engines. The output DMA engines move digital data from system memory to a D-A converter in a codec. The PCH implements a single Serial Data Output signal (HDA_SDO) that is connected to all external codecs. The input DMA engines move digital data from the A-D converter in the codec to system memory. The PCH implements four Serial Digital Input signals (HDA_SDI[3:0]) supporting up to four codecs.

Audio software renders outbound and processes inbound data to/from buffers in system memory. The location of individual buffers is described by a Buffer Descriptor List (BDL) that is fetched and processed by the controller. The data in the buffers is arranged in a predefined format. The output DMA engines fetch the digital data from memory and reformat it based on the programmed sample rate, bit/sample and number of channels. The data from the output DMA engines is then combined and serially sent to the external codecs over the Intel High Definition Audio link. The input DMA engines receive data from the codecs over the Intel High Definition Audio link and format the data based on the programmable attributes for that stream. The data is then written to memory in the predefined format for software to process. Each DMA engine moves one stream of data. A single codec can accept or generate multiple streams of data, one for each A-D or D-A converter in the codec. Multiple codecs can accept the same output stream processed by a single DMA engine.

Codec commands and responses are also transported to and from the codecs using DMA engines.

The PCH HD audio controller supports the Function Level Reset (FLR).

5.22.1 Intel® High Definition Audio Docking (Mobile Only)

5.22.1.1 Dock Sequence

Note that this sequence is followed when the system is running and a docking event occurs.

1. Since the PCH supports docking, the Docking Supported (DCKSTS.DS) bit defaults to a 1. POST BIOS and ACPI BIOS software uses this bit to determine if the HD Audio controller supports docking. BIOS may write a 0 to this R/WO bit during POST to effectively turn off the docking feature.
2. After reset in the undocked quiescent state, the Dock Attach (DCKCTL.DA) bit and the Dock Mate (DCKSTS.DM) bit are both deasserted. The HDA_DOCK_EN# signal is deasserted and HDA_DOCK_RST# is asserted. Bit Clock, SYNC and SDO signals may or may not be running at the point in time that the docking event occurs.
3. The physical docking event is signaled to ACPI BIOS software using ACPI control methods. This is normally done through a GPIO signal on the PCH and is outside the scope of this section of the specification.
4. ACPI BIOS software first checks that the docking is supported using DCKSTS.DS=1 and that the DCKSTS.DM=0 and then initiates the docking sequence by writing a 1 to the DCKCTL.DA bit.

5. The HD Audio controller then asserts the HDA_DOCK_EN# signal so that the Bit Clock signal begins toggling to the dock codec. HDA_DOCK_EN# shall be asserted synchronously to Bit Clock and timed such that Bit Clock is low, SYNC is low, and SDO is low. Pull-down resistors on these signals in the docking station discharge the signals low so that when the state of the signal on both sides of the switch is the same when the switch is turned on. This reduces the potential for charge coupling glitches on these signals. Note that in the PCH the first 8 bits of the Command field are "reserved" and always driven to 0's. This creates a predictable point in time to always assert HDA_DOCK_EN#. Note that the HD Audio link reset exit specification that requires that SYNC and SDO be driven low during Bit Clock startup is not ensured. Note also that the SDO and Bit Clock signals may not be low while HDA_DOCK_RST# is asserted which also violates the specification.
6. After the controller asserts HDA_DOCK_EN# it waits for a minimum of 2400 Bit Clocks (100 μ s) and then deasserts HDA_DOCK_RST#. This is done in such a way to meet the HD Audio link reset exit specification. HDA_DOCK_RST# deassertion should be synchronous to Bit Clock and timed such that there are least 4 full Bit Clocks from the deassertion of HDA_DOCK_RST# to the first frame SYNC assertion.
7. The Connect/Turnaround/Address Frame hardware initialization sequence will now occur on the dock codecs' SDI signals. A dock codec is detected when SDI is high on the last Bit Clock cycle of the Frame Sync of a Connect Frame. The appropriate bit(s) in the State Change Status (STATESTS) register will be set. The Turnaround and Address Frame initialization sequence then occurs on the dock codecs' SDI(s).
8. After this hardware initialization sequence is complete (approximately 32 frames), the controller hardware sets the DCKSTS.DM bit to 1 indicating that the dock is now mated. ACPI BIOS polls the DCKSTS.DM bit and when it detects it is set to 1, conveys this to the OS through a plug-N-play IRP. This eventually invokes the HD Audio Bus Driver, which then begins it's codec discovery, enumeration, and configuration process.
9. Alternatively to step #8, the HD Audio Bus Driver may choose to enable an interrupt by setting the WAKEEN bits for SDINs that didn't originally have codecs attached to them. When a corresponding STATESTS bit gets set an interrupt will be generated. In this case the HD Audio Bus Driver is called directly by this interrupt instead of being notified by the plug-N-play IRP.
10. Intel HD Audio Bus Driver software "discovers" the dock codecs by comparing the bits now set in the STATESTS register with the bits that were set prior to the docking event.

5.22.1.2 Exiting D3/CRST# When Docked

1. In D3/CRST#, CRST# is asserted by the HD Audio Bus Driver. CRST# asserted resets the dock state machines, but does not reset the DCKCTL.DA bit. Because the dock state machines are reset, the dock is electrically isolated (HDA_DOCK_EN# deasserted) and DOCK_RST# is asserted.
2. The Bus Driver clears the STATESTS bits, then deasserts CRST#, waits approximately 7 ms, then checks the STATESTS bits to see which codecs are present.
3. When CRST# is deasserted, the dock state machine detects that DCKCTL.DA is still set and the controller hardware sequences through steps to electrically connect the dock by asserting HDA_DOCK_EN# and then eventually deasserts DOCK_RST#. This completes within the 7ms mentioned in step 2).
4. The Bus Driver enumerates the codecs present as indicated using the STATESTS bits.
5. Note that this process did not require BIOS or ACPI BIOS to set the DCKCTL.DA bit.



5.22.1.3 Cold Boot/Resume from S3 When Docked

1. When booting and resuming from S3, PLTRST# switches from asserted to deasserted. This clears the DCKCTL.DA bit and the dock state machines. Because the dock state machines are reset, the dock is electrically isolated (HDA_DOCK_EN# deasserted) and DOCK_RST# is asserted.
2. POST BIOS detects that the dock is attached and sets the DCKCTL.DA bit to 1. Note that at this point CRST# is still asserted so the dock state machine will remain in its reset state.
3. The Bus Driver clears the STATESTS bits, then deasserts CRST#, waits approximately 7ms, then checks the STATESTS bits to see which codecs are present.
4. When CRST# is deasserted, the dock state machine detects that DCKCTL.DA is still set and the controller hardware sequences through steps to electrically connect the dock by asserting HDA_DOCK_EN# and then eventually deasserts DOCK_RST#. This completes within the 7ms mentioned in step 3).
5. The Bus Driver enumerates the codecs present as indicated using the STATESTS bits.

5.22.1.4 Undock Sequence

There are two possible undocking scenarios. The first is the one that is initiated by the user that invokes software and gracefully shuts down the dock codecs before they are undocked. The second is referred to as the "surprise undock" where the user undocks while the dock codec is running. Both of these situations appear the same to the controller as it is not cognizant of the "surprise removal". But both sequences will be discussed here.

5.22.1.5 Normal Undock

1. In the docked quiescent state, the Dock Attach (DCKCTL.DA) bit and the Dock Mate (DCKSTS.DM) bit are both asserted. The HDA_DOCK_EN# signal is asserted and HDA_DOCK_RST# is deasserted.
2. The user initiates an undock event through the GUI interface or by pushing a button. This mechanism is outside the scope of this section of the document. Either way ACPI BIOS software will be invoked to manage the undock process.
3. ACPI BIOS will call the HD Audio Bus Driver software in order to halt the stream to the dock codec(s) prior to electrical undocking. If the HD Audio Bus Driver is not capable of halting the stream to the docked codec, ACPI BIOS will initiate the hardware undocking sequence as described in the next step while the dock stream is still running. From this standpoint, the result is similar to the "surprise undock" scenario where an audio glitch may occur to the docked codec(s) during the undock process.
4. The ACPI BIOS initiates the hardware undocking sequence by writing a 0 to the DCKCTL.DA bit.
5. The HD Audio controller asserts HDA_DOCK_RST#. HDA_DOCK_RST# assertion shall be synchronous to Bit Clock. There are no other timing requirements for HDA_DOCK_RST# assertion. Note that the HD Audio link reset specification requirement that the last Frame sync be skipped will not be met.
6. A minimum of 4 Bit Clocks after HDA_DOCK_RST# the controller will deassert HDA_DOCK_EN# to isolate the dock codec signals from the PCH HD Audio link signals. HDA_DOCK_EN# is deasserted synchronously to Bit Clock and timed such that Bit Clock, SYNC, and SDO are low.
7. After this hardware undocking sequence is complete the controller hardware clears the DCKSTS.DM bit to 0 indicating that the dock is now un-mated. ACPI BIOS software polls DCKSTS.DM and when it sees DM set, conveys to the end user that physical undocking can proceed. The controller is now ready for a subsequent docking event.

5.22.1.6 Surprise Undock

1. In the surprise undock case the user undocks before software has had the opportunity to gracefully halt the stream to the dock codec and initiate the hardware undock sequence.
2. A signal on the docking connector is connected to the switch that isolates the dock codec signals from the PCH HD Audio link signals (DOCK_DET# in the conceptual diagram). When the undock event begins to occur the switch will be put into isolate mode.
3. The undock event is communicated to the ACPI BIOS using ACPI control methods that are outside the scope of this section of the document.
4. ACPI BIOS software writes a 0 to the DCKCTL.DA bit. ACPI BIOS then calls the HD Audio Bus Driver using plug-N-play IRP. The Bus Driver then posthumously cleans up the dock codec stream.
5. The HD Audio controller hardware is oblivious to the fact that a surprise undock occurred. The flow from this point on is identical to the normal undocking sequence described in section 0 starting at step 3). It finishes with the hardware clearing the DCKSTS.DM bit set to 0 indicating that the dock is now un-mated. The controller is now ready for a subsequent docking event.

5.22.1.7 Interaction between Dock/Undock and Power Management States

When exiting from S3, PLTRST# will be asserted. The POST BIOS is responsible for initiating the docking sequence if the dock is already attached when PLTRST# is deasserted. POST BIOS writes a 1 to the DCKCTL.DA bit prior to the HD Audio driver deasserting CRTS# and detecting and enumerating the codecs attached to the HDA_DOCK_RST# signal. The HD Audio controller does not directly monitor a hardware signal indicating that a dock is attached. Therefore a method outside the scope of this document must be used to cause the POST BIOS to initiate the docking sequence.

When exiting from D3, CRST# will be asserted. When CRST# bit is "0" (asserted), the DCKCTL.DA bit is not cleared. The dock state machine will be reset such that HDA_DOCK_EN# will be deasserted, HDA_DOCK_RST# will be asserted and the DCKSTS.DM bit will be cleared to reflect this state. When the CRST# bit is deasserted, the dock state machine will detect that DCKCTL.DA is set to "1" and will begin sequencing through the dock process. Note that this does not require any software intervention.

5.22.1.8 Relationship between HDA_DOCK_RST# and HDA_RST#

HDA_RST# will be asserted when a PLTRST# occurs or when the CRST# bit is 0. As long as HDA_RST# is asserted, the DOCK_RST# signal will also be asserted.

When PLTRST# is asserted, the DCKCTL.DA and DCKSTS.DM bits will be get cleared to their default state (0's), and the dock state machine will be reset such that HDA_DOCK_EN# will be deasserted, and HDA_DOCK_RST# will be asserted. After any PLTRST#, POST BIOS software is responsible for detecting that a dock is attached and then writing a "1" to the DCKCTL.DA bit prior to the HD Audio Bus Driver deasserting CRST#.

When CRST# bit is "0" (asserted), the DCKCTL.DA bit is not cleared. The dock state machine will be reset such that HDA_DOCK_EN# will be deasserted, HDA_DOCK_RST# will be asserted and the DCKSTS.DM bit will be cleared to reflect this state. When the CRST# bit is deasserted, the dock state machine will detect that DCKCTL.DA is set to "1" and will begin sequencing through the dock process. Note that this does not require any software intervention.



5.23 Intel® ME and Intel® ME Firmware 7.0

In 2005 Intel developed a set of manageability services called Intel® Active Management Technology (Intel® AMT). To increase features and reduce cost in 2006 Intel integrated the operating environment for Intel AMT to run on all Intel chipsets:

- A microcontroller and support HW was integrated in the MCH
- Additional support HW resided in ICH

This embedded operating environment is called the Intel Manageability Engine (Intel ME). In 2009 with platform repartitioning Intel ME was designed to reside in the PCH. Key properties of Intel ME:

- Connectivity
 - Integration into I/O subsystem of PCH
 - Delivers advanced I/O functions
- Security
 - More secure (Intel root of trust) & isolated execution
 - Increased security of flash file system
- Modularity & Partitioning
 - OSV, VMM & SW Independence
 - Respond rapidly to competitive changes
- Power
 - Always On Always Connected
 - Advanced functions in low power S3-S4-S5 operation
 - OS independent PM & thermal heuristics

Intel ME FW provides a variety of services that range from low-level hardware initialization and provisioning to high-level end-user software based IT manageability services. One of Intel ME FW's most established and recognizable features is Intel Active Management Technology.

Intel® Active Management Technology is a set of advanced manageability features developed to meet the evolving demands placed on IT to manage a network infrastructure. Intel® AMT reduces the Total Cost of Ownership (TCO) for IT management through features such as asset tracking, remote manageability, and robust policy-based security, resulting in fewer desk-side visits and reduced incident support durations. Intel AMT extends the manageability capability for IT through Out Of Band (OOB), allowing asset information, remote diagnostics, recovery, and contain capabilities to be available on client systems even when they are in a low power, or "off" state, or in situations when the operating system is hung.

For more details on various Intel ME FW features supported by Intel ME FW, such as **Intel Active Management Technology**, please refer to the relevant FW feature Product Requirements Document (PRD).

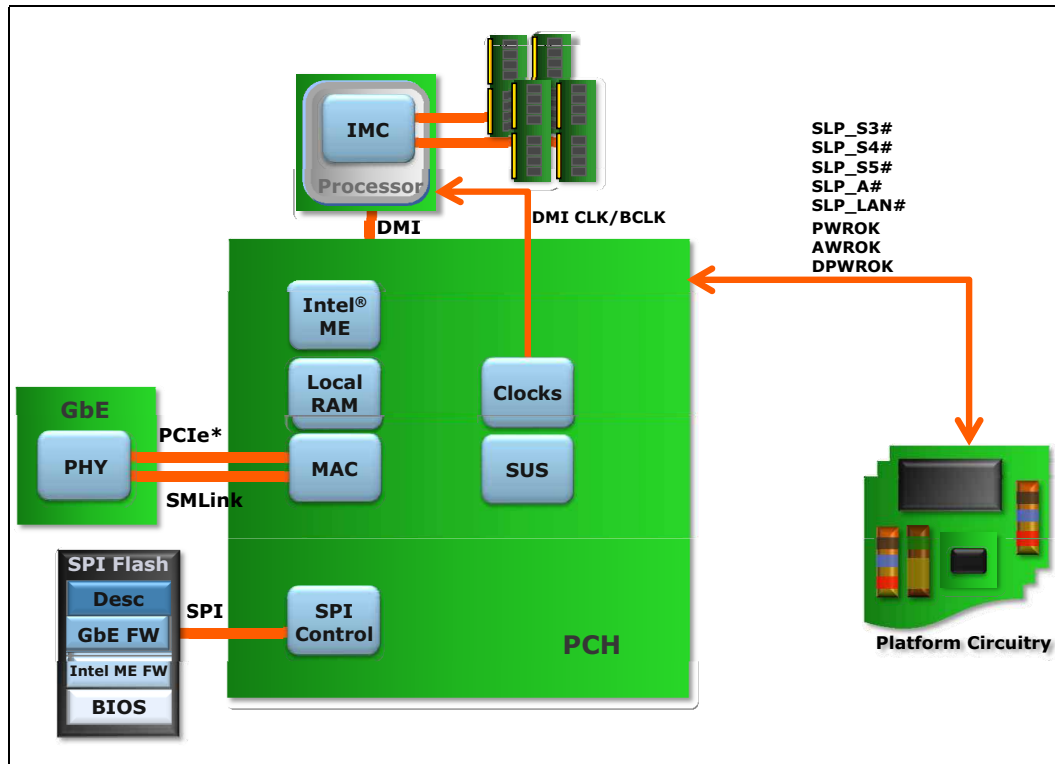
Figure 5-11. PCH Intel® Management Engine High-Level Block Diagram

5.23.1 Intel® ME Requirements

Intel ME is a platform-level solution that utilizes multiple system components including:

- The Intel ME is the general purpose controller that resides in the PCH. It operates in parallel to, and is resource-isolated from, the host processor.
- The flash device stores Intel ME Firmware code that is executed by the Intel ME for its operations. In M0, the highest power state, this code is loaded from flash into DRAM and cached in secure and isolated SRAM. Code that resides in DRAM is stored in 16 MB of unified memory architecture (UMA) memory taken off the highest order rank in channel 0. The PCH controls the flash device through the SPI interface and internal logic.
- In order to interface with DRAM, the Intel ME utilizes the integrated memory controller (IMC) present in the processor. DMI serves as the interface for communication between the IMC and Intel ME. This interfacing occurs in only M0 power state. In the lower Intel ME power state, M3, code is executed exclusively from secure and isolated Intel ME local RAM.
- The LAN controller embedded in the PCH as well as the Intel Gigabit Platform LAN Connect device are required for Intel ME and Intel AMT network connectivity.
- BIOS to provide asset detection and POST diagnostics (BIOS and Intel AMT can optionally share same flash memory device)
- An ISV software package, such as LANDesk*, Altiris*, or Microsoft* SMS, can be used to take advantage of the platform manageability capabilities of Intel AMT.



5.24 Serial Peripheral Interface (SPI)

The Serial Peripheral Interface (SPI) is a 4-pin interface that provides a lower-cost alternative for system flash versus the Firmware Hub on the LPC bus.

The 4-pin SPI interface consists of clock (CLK), master data out (Master Out Slave In (MOSI)), master data in (Master In Slave Out (MISO)) and an active low chip select (SPI_CS[1:0]#).

The PCH supports up to two SPI flash devices using two separate Chip Select pins. Each SPI flash device can be up to 16 MB. The PCH SPI interface supports 20 MHz, 33 MHz, and 50 MHz SPI devices. A SPI Flash device on with Chip Select 0 with a valid descriptor MUST be attached directly to the PCH.

Communication on the SPI bus is done with a Master – Slave protocol. The Slave is connected to the PCH and is implemented as a tri-state bus.

Note: If Boot BIOS Strap = '00' then LPC is selected as the location for BIOS. BIOS may still be placed on LPC, but all platforms with the PCH require a SPI flash connected directly to the PCH's SPI bus with a valid descriptor connected to Chip Select 0 in order to boot.

Note: When SPI is selected by the Boot BIOS Destination Strap and a SPI device is detected by the PCH, LPC based BIOS flash is disabled.

5.24.1 SPI Supported Feature Overview

SPI Flash on the PCH has two operational modes, descriptor and non-descriptor.

5.24.1.1 Non-Descriptor Mode

Non-Descriptor Mode is not supported as a valid flash descriptor is required for all PCH Platforms.

5.24.1.2 Descriptor Mode

Descriptor Mode is required for all SKUs of the PCH. It enables many new features of the chipset:

- Integrated Gigabit Ethernet and Host processor for Gigabit Ethernet Software
- Intel Active Management Technology
- Intel Management Engine Firmware
- PCI Express* root port configuration
- Supports up to two SPI components using two separate chip select pins
- Hardware enforced security restricting master accesses to different regions
- Chipset Soft Strap regions provides the ability to use Flash NVM as an alternative to hardware pull-up/pull-down resistors for the PCH and processor
- Supports the SPI Fast Read instruction and frequencies of up to 50 MHz
- Support Single Input, Dual Output Fast read
- Uses standardized Flash Instruction Set

5.24.1.2.1 SPI Flash Regions

In Descriptor Mode the Flash is divided into five separate regions:

Region	Content
0	Flash Descriptor
1	BIOS
2	Intel Management Engine
3	Gigabit Ethernet
4	Platform Data

Only three masters can access the four regions: Host processor running BIOS code, Integrated Gigabit Ethernet and Host processor running Gigabit Ethernet Software, and Intel Management Engine. The only required region is Region 0, the Flash Descriptor. Region 0 must be located in the first sector of Device 0 (Offset 0).

Flash Region Sizes

SPI flash space requirements differ by platform and configuration. The Flash Descriptor requires one 4 KB or larger block. GbE requires two 4 KB or larger blocks. The amount of flash space consumed is dependent on the erase granularity of the flash part and the platform requirements for the Intel ME and BIOS regions. The Intel ME region contains firmware to support Intel Active Management Technology and other Intel ME capabilities.

Table 5-56. Region Size versus Erase Granularity of Flash Components

Region	Size with 4 KB Blocks	Size with 8 KB Blocks	Size with 64 KB Blocks
Descriptor	4 KB	8 KB	64 KB
GbE	8 KB	16 KB	128 KB
BIOS	Varies by Platform	Varies by Platform	Varies by Platform
Intel ME	Varies by Platform	Varies by Platform	Varies by Platform

5.24.2 Flash Descriptor

The maximum size of the Flash Descriptor is 4 KB. If the block/sector size of the SPI flash device is greater than 4 KB, the flash descriptor will only use the first 4 KB of the first block. The flash descriptor requires its own block at the bottom of memory (00h). The information stored in the Flash Descriptor can only be written during the manufacturing process as its read/write permissions must be set to Read only when the computer leaves the manufacturing floor.

The Flash Descriptor is made up of eleven sections (see [Figure 5-12](#)).

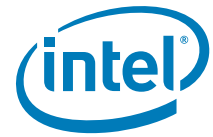
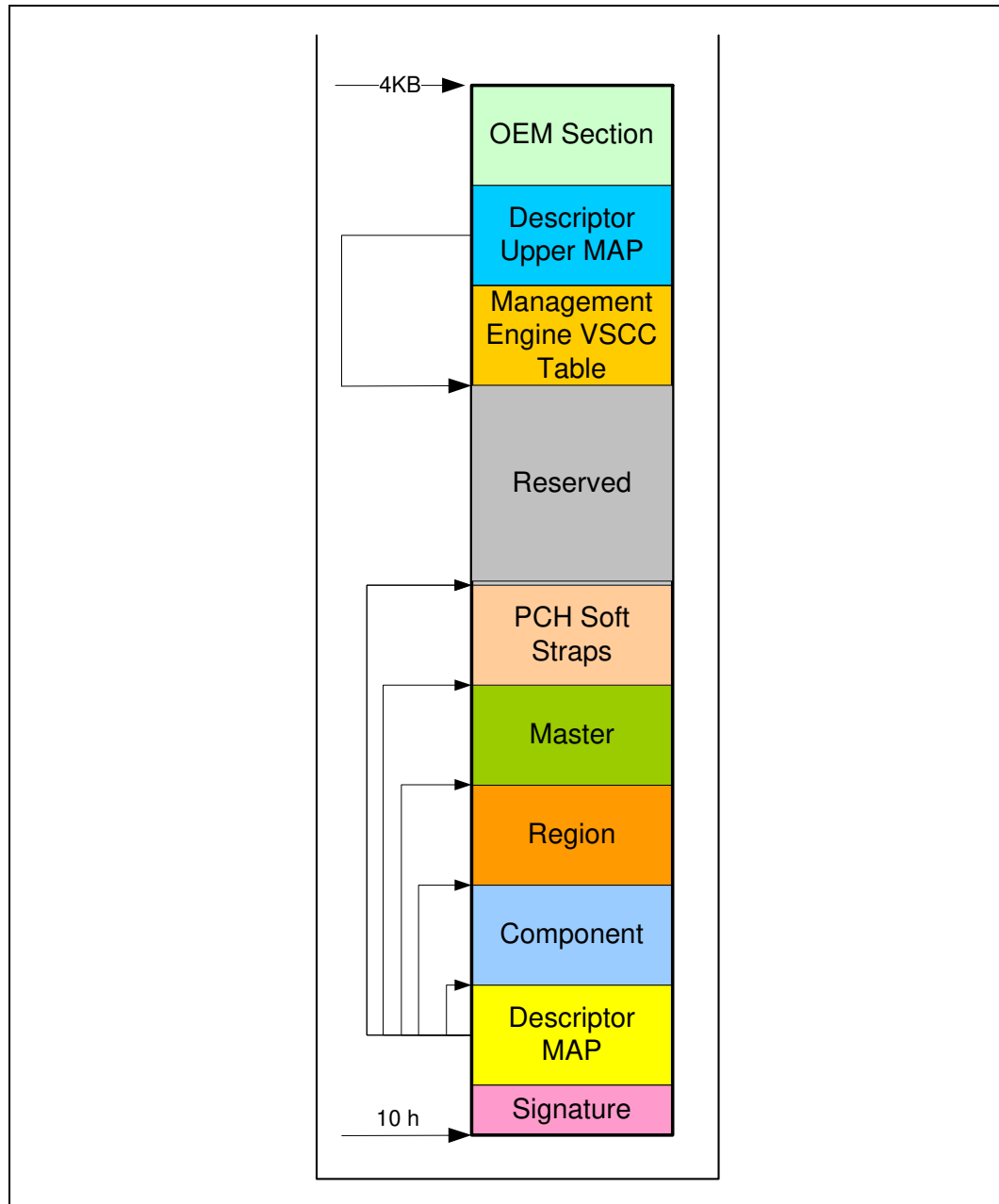
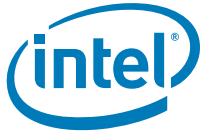

Figure 5-12. Flash Descriptor Sections



1. The Flash signature selects Descriptor Mode as well as verifies if the flash is programmed and functioning. The data at the bottom of the flash (offset 10h) must be 0FF0A55Ah in order to be in Descriptor mode.
2. The Descriptor map has pointers to the other five descriptor sections as well as the size of each.



3. The component section has information about the SPI flash in the system including: the number of components, density of each, illegal instructions (such as chip erase), and frequencies for read, fast read and write/erase instructions.
4. The Region section points to the three other regions as well as the size of each region.
5. The master region contains the security settings for the flash, granting read/write permissions for each region and identifying each master by a requestor ID. See [Section 5.24.2.1](#) for more information.
- 6 & 7. The processor and PCH soft strap sections contain processor and PCH configurable parameters.
8. The Reserved region between the top of the processor strap section and the bottom of the OEM Section is reserved for future chipset usages.
9. The Descriptor Upper MAP determines the length and base address of the Management Engine VSCC Table.
10. The Management Engine VSCC Table holds the JEDEC ID and the VSCC information of the entire SPI Flash supported by the NVM image.
11. OEM Section is 256 Bytes reserved at the top of the Flash Descriptor for use by OEM.

5.24.2.1 Descriptor Master Region

The master region defines read and write access setting for each region of the SPI device. The master region recognizes three masters: BIOS, Gigabit Ethernet, and Management Engine. Each master is only allowed to do direct reads of its primary regions.

Table 5-57. Region Access Control Table

Master Read/Write Access			
Region	Processor and BIOS	ME	GbE Controller
Descriptor	N/A	N/A	N/A
BIOS	Processor and BIOS can always read from and write to BIOS Region	Read / Write	Read / Write
Management Engine	Read / Write	Intel® ME can always read from and write to Intel ME Region	Read / Write
Gigabit Ethernet	Read / Write	Read / Write	GbE software can always read from and write to GbE region
Platform Data Region	N/A	N/A	N/A



5.24.3 Flash Access

There are two types of flash accesses:

Direct Access:

- Masters are allowed to do direct read only of their primary region
 - Gigabit Ethernet region can only be directly accessed by the Gigabit Ethernet controller. Gigabit Ethernet software must use Program Registers to access the Gigabit Ethernet region.
- Master's Host or Management Engine virtual read address is converted into the SPI Flash Linear Address (FLA) using the Flash Descriptor Region Base/Limit registers

Program Register Access:

- Program Register Accesses are not allowed to cross a 4 KB boundary and can not issue a command that might extend across two components
- Software programs the FLA corresponding to the region desired
 - Software must read the devices Primary Region Base/Limit address to create a FLA.

5.24.3.1 Direct Access Security

- Requester ID of the device must match that of the primary Requester ID in the Master Section
- Calculated Flash Linear Address must fall between primary region base/limit
- Direct Write not allowed
- Direct Read Cache contents are reset to 0's on a read from a different master
 - Supports the same cache flush mechanism in ICH7 which includes Program Register Writes

5.24.3.2 Register Access Security

- Only primary region masters can access the registers

Note: Processor running Gigabit Ethernet software can access Gigabit Ethernet registers

- Masters are only allowed to read or write those regions they have read/write permission
- Using the Flash Region Access Permissions, one master can give another master read/write permissions to their area
- Using the five Protected Range registers, each master can add separate read/write protection above that granted in the Flash Descriptor for their own accesses
 - Example: BIOS may want to protect different regions of BIOS from being erased
 - Ranges can extend across region boundaries

5.24.4 Serial Flash Device Compatibility Requirements

A variety of serial flash devices exist in the market. For a serial flash device to be compatible with the PCH SPI bus, it must meet the minimum requirements detailed in the following sections.

Note: All PCH platforms have require Intel® Management Engine Firmware.

5.24.4.1 PCH SPI-Based BIOS Requirements

A serial flash device must meet the following minimum requirements when used explicitly for system BIOS storage.

- Erase size capability of at least one of the following: 64 Kbytes, 8 Kbytes, 4 Kbytes, or 256 bytes.
- Device must support multiple writes to a page without requiring a preceding erase cycle (Refer to [Section 5.24.5](#))
- Serial flash device must ignore the upper address bits such that an address of FFFFFFFh aliases to the top of the flash memory.
- SPI Compatible Mode 0 support (clock phase is 0 and data is latched on the rising edge of the clock).
- If the device receives a command that is not supported or incomplete (less than 8 bits), the device must complete the cycle gracefully without any impact on the flash content.
- An erase command (page, sector, block, chip, etc.) must set all bits inside the designated area (page, sector, block, chip, etc.) to 1 (Fh).
- Status Register bit 0 must be set to 1 when a write, erase or write to status register is in progress and cleared to 0 when a write or erase is NOT in progress.
- Devices requiring the Write Enable command must automatically clear the Write Enable Latch at the end of Data Program instructions.
- Byte write must be supported. The flexibility to perform a write between 1 byte to 64 bytes is recommended.
- Hardware Sequencing requirements are optional in BIOS only platforms.
- SPI flash parts that do not meet Hardware sequencing command set requirements may work in BIOS only platforms using software sequencing.

5.24.4.2 Integrated LAN Firmware SPI Flash Requirements

A serial flash device that will be used for system BIOS and Integrated LAN or Integrated LAN only must meet all the SPI Based BIOS Requirements plus:

- Hardware sequencing
- 4-, 8-, or 64-KB erase capability must be supported.

5.24.4.2.1 SPI Flash Unlocking Requirements for Integrated LAN

BIOS must ensure there is no SPI flash based read/write/erase protection on the GbE region. GbE firmware and drivers for the integrated LAN need to be able to read, write and erase the GbE region at all times.



5.24.4.3 Intel® Management Engine Firmware SPI Flash Requirements

Intel Management Engine Firmware must meet the SPI flash based BIOS Requirements plus:

- Hardware Sequencing.
- Flash part must be uniform 4-KB erasable block throughout the entire device or have 64-KB blocks with the first block (lowest address) divided into 4-KB or 8-KB blocks.
- Write protection scheme must meet SPI flash unlocking requirements for Intel ME.

5.24.4.3.1 SPI Flash Unlocking Requirements for Intel® Management Engine

Flash devices must be globally unlocked (read, write and erase access on the ME region) from power on by writing 00h to the flash's status register to disable write protection.

If the status register must be unprotected, it must use the enable write status register command 50h or write enable 06h.

Opcode 01h (write to status register) must then be used to write a single byte of 00h into the status register. This must unlock the entire part. If the SPI flash's status register has non-volatile bits that must be written to, bits [5:2] of the flash's status register must be all 0h to indicate that the flash is unlocked.

If bits [5:2] return a non zero values, the Intel ME firmware will send a write of 00h to the status register. This must keep the flash part unlocked.

If there is no need to execute a write enable on the status register, then opcodes 06h and 50h must be ignored.

After global unlock, BIOS has the ability to lock down small sections of the flash as long as they do not involve the Intel ME or GbE region.

5.24.4.4 Hardware Sequencing Requirements

Table 5-58 contains a list of commands and the associated opcodes that a SPI-based serial flash device must support in order to be compatible with hardware sequencing.

Table 5-58. Hardware Sequencing Commands and Opcode Requirements

Commands	Opcode	Notes
Write to Status Register	01h	Writes a byte to SPI flash's status register. Enable Write to Status Register command must be run prior to this command.
Program Data	02h	Single byte or 64 byte write as determined by flash part capabilities and software.
Read Data	03h	
Write Disable	04h	
Read Status	05h	Outputs contents of SPI flash's status register
Write Enable	06h	
Fast Read	0Bh	
Enable Write to Status Register	50h or 60h	Enables a bit in the status register to allow an update to the status register
Erase	Program mable	256B, 4 Kbyte, 8 Kbyte or 64 Kbyte
Full Chip Erase	C7h	
JEDEC ID	9Fh	See Section 5.24.4.4.3 .

5.24.4.4.1 Single Input, Dual Output Fast Read

The PCH now supports the functionality of a single input, dual output fast read. Opcode and address phase are shifted in serially to the serial flash SI (Serial In) pin. Data is read out after 8 clocks (dummy bits or wait states) from the both the SI and SO pin effectively doubling the through put of each fast read output. In order to enable this functionality, both Single Input Dual Output Fast Read Supported and Fast Read supported must be enabled

5.24.4.4.2 Serial Flash Discoverable Parameters (SFDP)

As the number of features keeps growing in the serial flash, the need for correct, accurate configuration increases. A new method of determining configuration information is Serial Flash Discoverable Parameters (SFDP). Information such as VSCC values and flash attributes can be read directly from the flash parts. The discoverable parameter read opcode behaves like a fast read command. The opcode is 5Ah and the address cycle is 24 bits long. After the opcode 5Ah and address are clocked in, there will then be eight clocks (8 wait states) before valid data is clocked out. SFDP is a capability of the flash part, please confirm with target flash vendor to see if it is supported.

In order for BIOS to take advantage of the 5Ah opcode it needs to be programmed in the Software sequencing registers.

5.24.4.4.3 JEDEC ID

Since each serial flash device may have unique capabilities and commands, the JEDEC ID is the necessary mechanism for identifying the device so the uniqueness of the device can be comprehended by the controller (master). The JEDEC ID uses the opcode 9Fh and a specified implementation and usage model. This JEDEC Standard Manufacturer and Device ID read method is defined in Standard JESD21-C, PRN03-NV.

5.24.5 Multiple Page Write Usage Model

The system BIOS and Intel® Management Engine firmware usage models require that the serial flash device support multiple writes to a page (minimum of 512 writes) without requiring a preceding erase command. BIOS commonly uses capabilities such as counters that are used for error logging and system boot progress logging. These counters are typically implemented by using byte-writes to 'increment' the bits within a page that have been designated as the counter. The Intel® ME firmware usage model requires the capability for multiple data updates within any given page. These data updates occur using byte-writes without executing a preceding erase to the given page. Both the BIOS and Intel® ME firmware multiple page write usage models apply to sequential and non-sequential data writes.

Note: This usage model requirement is based on any given bit only being written once from a '1' to a '0' without requiring the preceding erase. An erase would be required to change bits back to the 1 state.



5.24.5.1 Soft Flash Protection

There are two types of flash protection that are not defined in the flash descriptor supported by PCH:

1. BIOS Range Write Protection
2. SMI#-Based Global Write Protection

Both mechanisms are logically OR'd together such that if any of the mechanisms indicate that the access should be blocked, then it is blocked. [Table 5-59](#) provides a summary of the mechanisms.

Table 5-59. Flash Protection Mechanism Summary

Mechanism	Accesses Blocked	Range Specific?	Reset-Override or SMI#-Override?	Equivalent Function on FWH
BIOS Range Write Protection	Writes	Yes	Reset Override	FWH Sector Protection
Write Protect	Writes	No	SMI# Override	Same as Write Protect in Intel® ICHs for FWH

A blocked command will appear to software to finish, except that the Blocked Access status bit is set in this case.

5.24.5.2 BIOS Range Write Protection

The PCH provides a method for blocking writes to specific ranges in the SPI flash when the Protected BIOS Ranges are enabled. This is achieved by checking the Opcode type information (which can be locked down by the initial Boot BIOS) and the address of the requested command against the base and limit fields of a Write Protected BIOS range.

Note: Once BIOS has locked down the Protected BIOS Range registers, this mechanism remains in place until the next system reset.

5.24.5.3 SMI# Based Global Write Protection

The PCH provides a method for blocking writes to the SPI flash when the Write Protected bit is cleared (that is, protected). This is achieved by checking the Opcode type information (which can be locked down by the initial Boot BIOS) of the requested command.

The Write Protect and Lock Enable bits interact in the same manner for SPI BIOS as they do for the FWH BIOS.

5.24.6 Flash Device Configurations

The PCH-based platform must have a SPI flash connected directly to the PCH with a valid descriptor and Intel Management Engine Firmware. BIOS may be stored in other locations such as Firmware Hub and SPI flash hooked up directly to an embedded controller for Mobile platforms. Note this will not avoid the direct SPI flash connected to PCH requirement.

5.24.7 SPI Flash Device Recommended Pinout

Table 5-60 contains the recommended serial flash device pin-out for an 8-pin device. Use of the recommended pin-out on an 8-pin device reduces complexities involved with designing the serial flash device onto a motherboard and allows for support of a common footprint usage model (refer to Section 5.24.8.1).

Table 5-60. Recommended Pinout for 8-Pin Serial Flash Device

Pin #	Signal
1	Chips Select
2	Data Output
3	Write Protect
4	Ground
5	Data Input
6	Serial Clock
7	Hold / Reset
8	Supply Voltage

Although an 8-pin device is preferred over a 16-pin device due to footprint compatibility, the following table contains the recommended serial flash device pin-out for a 16-pin SOIC.

5.24.8 Serial Flash Device Package

Table 5-61. Recommended Pinout for 16-Pin Serial Flash Device

Pin #	Signal	Pin #	Signal
1	Hold / Reset	9	Write Protect
2	Supply Voltage	10	Ground
3	No Connect	11	No Connect
4	No Connect	12	No Connect
5	No Connect	13	No Connect
6	No Connect	14	No Connect
7	Chip Select	15	Serial Data In
8	Serial Data Out	16	Serial Clock

5.24.8.1 Common Footprint Usage Model

In order to minimize platform motherboard redesign and to enable platform Bill of Material (BOM) selectability, many PC System OEMs design their motherboard with a single common footprint. This common footprint allows population of a soldered down device or a socket that accepts a leadless device. This enables the board manufacturer to support, using selection of the appropriate BOM, either of these solutions on the same system without requiring any board redesign.

The common footprint usage model is desirable during system debug and by flash content developers since the leadless device can be easily removed and reprogrammed without damage to device leads. When the board and flash content is mature for high-volume production, both the socketed leadless solution and the soldered down leaded solution are available through BOM selection.



5.24.8.2 Serial Flash Device Package Recommendations

It is highly recommended that the common footprint usage model be supported. An example of how this can be accomplished is as follows:

- The recommended pinout for 8-pin serial flash devices is used (refer to [Section 5.24.7](#)).
- The 8-pin device is supported in either an 8-contact VDFPN (6x5 mm MLP) package or an 8-contact WSON (5x6 mm) package. These packages can fit into a socket that is land pattern compatible with the wide body SO8 package.
- The 8-pin device is supported in the SO8 (150 mil) and in the wide-body SO8 (200 mil) packages.

The 16-pin device is supported in the SO16 (300 mil) package.

5.24.9 PWM Outputs (Server/Workstation Only)

This signal is driven as open-drain. An external pull-up resistor is integrated into the fan to provide the rising edge of the PWM output signal. The PWM output is driven low during reset, which represents 0% duty cycle to the fans. After reset deassertion, the PWM output will continue to be driven low until one of the following occurs:

- The internal PWM control register is programmed to a non-zero value by appropriate firmware.
- The watchdog timer expires (enabled and set at 4 seconds by default).
- The polarity of the signal is inverted by firmware.

Note that if a PWM output will be programmed to inverted polarity for a particular fan, then the low voltage driven during reset represents 100% duty cycle to the fan.

5.24.10 TACH Inputs (Server/Workstation Only)

This signal is driven as an open-collector or open-drain output from the fan. An external pull-up is expected to be implemented on the motherboard to provide the rising edge of the TACH input. This signal has analog hysteresis and digital filtering due to the potentially slow rise and fall times. This signal has a weak internal pull-up resistor to keep the input buffer from floating if the TACH input is not connected to a fan.

5.25 Feature Capability Mechanism

A set of registers is included in the PCH LPC Interface (Device 31, Function 0, offset E0h-EBh) that allows the system software or BIOS to easily determine the features supported by the PCH. These registers can be accessed through LPC PCI configuration space, thus allowing for convenient single point access mechanism for chipset feature detection.

This set of registers consists of:

- Capability ID (FDCAP)
- Capability Length (FDLEN)
- Capability Version and Vendor-Specific Capability ID (FDVER)
- Feature Vector (FVECT)

5.26 PCH Display Interfaces and Intel® Flexible Display Interconnect

Display is divided between processor and PCH. The processor houses memory interface, display planes, and pipes while PCH has transcoder and display interface or ports. Intel® FDI connects the processor and PCH display engine. The number of planes, pipes, and transcoders decide the number of simultaneous and concurrent display devices that can be driven on a platform.

The PCH integrates one Analog, LVDS (mobile only) and three Digital Ports B, C, and D. Each Digital Port can transmit data according to one or more protocols. Digital Port B, C, and D can be configured to drive natively HDMI, DisplayPort, or DVI. Digital Port B also supports Serial Digital Video Out (SDVO) that converts one protocol to another. Digital Port D can be configured to drive natively Embedded DisplayPort (eDP). Each display port has control signals that may be used to control, configure and/or determine the capabilities of an external device.

The PCH's Analog Port uses an integrated 340.4 MHz RAMDAC that can directly drive a standard progressive scan analog monitor up to a resolution of 2048x1536 pixels with 32-bit color at 75 Hz.

The PCH SDVO port (configured through Digital Port B) is capable of driving a 200 MP/s (Megapixels/second) rate.

Each digital port is capable of driving resolutions up to 2560x1600 at 60 Hz through DisplayPort and 1920x1200 at 60 Hz using HDMI or DVI (with reduced blanking).

5.26.1 Analog Display Interface Characteristics

The Analog Port provides a RGB signal output along with a HSYNC and VSYNC signal. There is an associated Display Data Channel (DDC) signal pair that is implemented using GPIO pins dedicated to the Analog Port. The intended target device is for a monitor with a VGA connector. Display devices such as LCD panels with analog inputs may work satisfactory but no functionality added to the signals to enhance that capability.

Figure 5-13. Analog Port Characteristics

Signal	Port Characteristic	Support
RGB	Voltage Range	0.7 V p-p only
	Monitor Sense	Analog Compare
	Analog Copy Protection	No
	Sync on Green	No
HSYNC VSYNC	Voltage	2.5 V
	Enable/Disable	Port control
	Polarity adjust	VGA or port control
	Composite Sync Support	No
	Special Flat Panel Sync	No
	Stereo Sync	No
DDC	Voltage	Externally buffered to 5V
	Control	Through GPIO interface



5.26.1.1 Integrated RAMDAC

The display function contains a RAM-based Digital-to-Analog Converter (RAMDAC) that transforms the digital data from the graphics and video subsystems to analog data for the VGA monitor. The PCH's integrated 340.4 MHz RAMDAC supports resolutions up to 2048x1536 at 75 Hz. Three 8-bit DACs provide the R, G, and B signals to the monitor.

5.26.1.1.1 Sync Signals

HSYNC and VSYNC signals are digital and conform to TTL signal levels at the connector. Since these levels cannot be generated internal to the device, external level shifting buffers are required. These signals can be polarity adjusted and individually disabled in one of the two possible states. The sync signals should power up disabled in the high state. No composite sync or special flat panel sync support are included.

5.26.1.1.2 VESA/VGA Mode

VESA/VGA mode provides compatibility for pre-existing software that set the display mode using the VGA CRTC registers. Timings are generated based on the VGA register values and the timing generator registers are not used.

5.26.1.2 DDC (Display Data Channel)

DDC is a standard defined by VESA. Its purpose is to allow communication between the host system and display. Both configuration and control information can be exchanged allowing plug- and-play systems to be realized. Support for DDC 1 and 2 is implemented. The PCH uses the DDC_CLK and DDC_DATA signals to communicate with the analog monitor. The PCH will generate these signals at 2.5 V. External pull-up resistors and level shifting circuitry should be implemented on the board.

5.26.2 Digital Display Interfaces

The PCH can drive a number of digital interfaces natively. The Digital Ports B, C, and/or D can be configured to drive HDMI, DVI, DisplayPort, and Embedded DisplayPort (port D only). The PCH provides a dedicated port for Digital Port LVDS (mobile only).

5.26.2.1 LVDS (Mobile only)

LVDS for flat panel is compatible with the ANSI/TIA/EIA-644 specification. This is an electrical standard only defining driver output characteristics and receiver input characteristics.

Each channel supports transmit clock frequency ranges from 25 MHz to 112 MHz, which provides a throughput of up to 784 Mbps on each data output and up to 112 MP/s on the input. When using both channels, each carry a portion of the data; thus, doubling the throughput to a maximum theoretical pixel rate of 224 MP/s.

There are two LVDS transmitter channels (Channel A and Channel B) in the LVDS interface. Channel A and Channel B consist of 4-data pairs and a clock pair each.

The LVDS data pair is used to transfer pixel data as well as the LCD timing control signals.

Figure 5-14 shows a pair of LVDS signals and swing voltage.

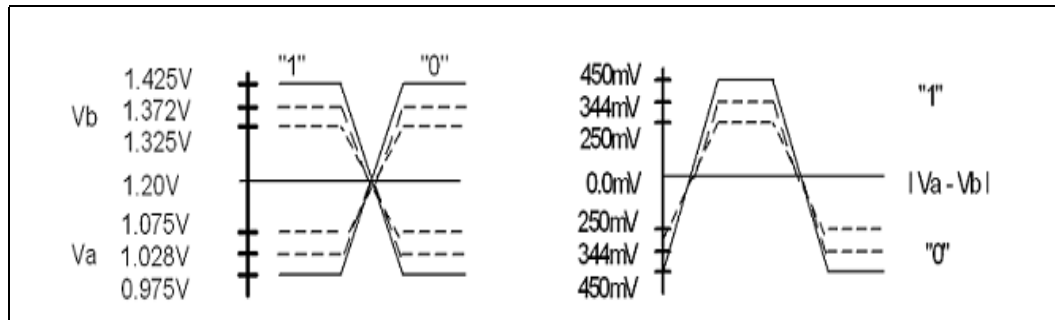
Figure 5-14. LVDS Signals and Swing Voltage

Logic values of 1s and 0s are represented by the differential voltage between the pair of signals. As shown in the [Figure 5-15](#) a serial pattern of 1100011 represents one cycle of the clock.

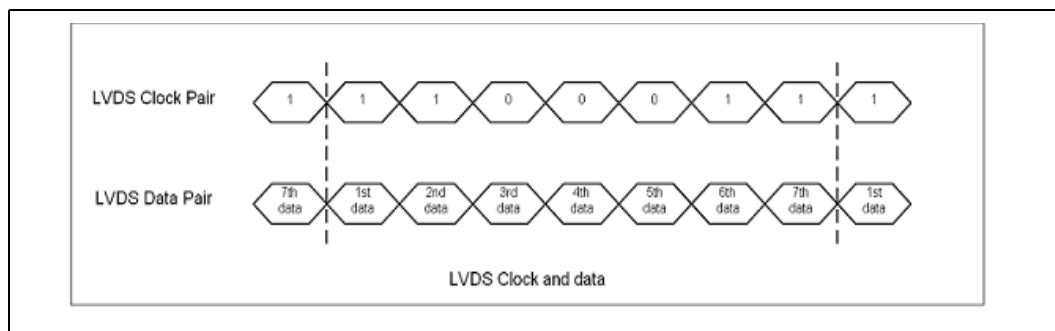
Figure 5-15. LVDS Clock and Data Relationship

5.26.2.1.1 LVDS Pair States

The LVDS pairs can be put into one of five states:

- Active
- Powered down Hi-Z
- Powered down 0 V
- Common mode
- Send zeros

When in the active state, several data formats are supported. When in powered down state, the circuit enters a low power state and drives out 0 V or the buffer is the Hi-Z state on both the output pins for the entire channel. The common mode Hi-Z state is both pins of the pair set to the common mode voltage. When in the send zeros state, the circuit is powered up but sends only zero for the pixel color data regardless what the actual data is with the clock lines and timing signals sending the normal clock and timing data.

The LVDS Port can be enabled/disabled using software. A disabled port enters a low power state. Once the port is enabled, individual driver pairs may be disabled based on the operating mode. Disabled drivers can be powered down for reduced power consumption or optionally fixed to forced 0s output.

Individual pairs or sets of LVDS pairs can be selectively powered down when not being used. The panel power sequencing can be set to override the selected power state of the drivers during power sequencing.



5.26.2.1.2 Single Channel versus Dual Channel Mode

In the single channel mode, only Channel-A is used. Channel-B cannot be used for single channel mode. In the dual channel mode, both Channel-A and Channel-B pins are used concurrently to drive one LVDS display.

In Single Channel mode, Channel A can take 18 bits of RGB pixel data, plus 3 bits of timing control (HSYNC/VSYNC/DE) and output them on three differential data pair outputs; or 24 bits of RGB (plus 4 bits of timing control) output on four differential data pair outputs. A dual channel interface converts 36 or 48 bits of color information plus the 3 or 4 bits of timing control respectively and outputs it on six or eight sets of differential data outputs respectively.

Dual Channel mode uses twice the number of LVDS pairs and transfers the pixel data at twice the rate of the single channel. In general, one channel will be used for even pixels and the other for odd pixel data. The first pixel of the line is determined by the display enable going active and that pixel will be sent out Channel-A. All horizontal timings for active, sync, and blank will be limited to be on two pixel boundaries in the two channel modes.

Note: Platforms using the PCH for integrated graphics support 24-bpp display panels of Type 1 only (compatible with VESA LVDS color mapping).

5.26.2.1.3 Panel Power Sequencing

This section provides details for the power sequence timing relationship of the panel power, the backlight enable and the LVDS data timing delivery. To meet the panel power timing specification requirements two signals, LFP_VDD_EN and LFP_BKLT_EN, are provided to control the timing sequencing function of the panel and the backlight power supplies.

A defined power sequence is recommended when enabling the panel or disabling the panel. The set of timing parameters can vary from panel to panel vendor, provided that they stay within a predefined range of values. The panel VDD power, the backlight on/off state and the LVDS clock and data lines are all managed by an internal power sequencer.

Figure 5-16. Panel Power Sequencing

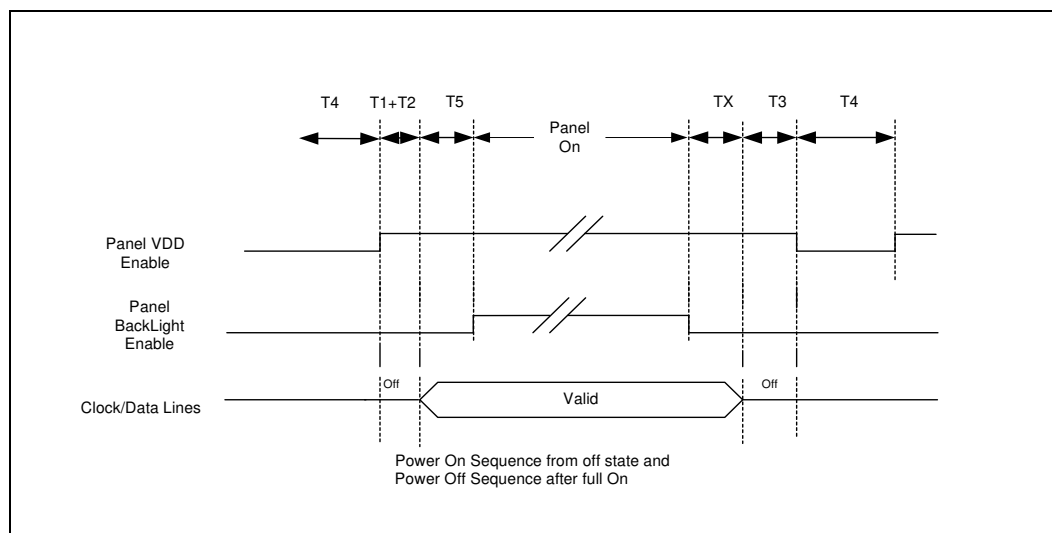

NOTE: Support for programming parameters TX and T1 through T5 using software is provided.

5.26.2.1.4 LVDS DDC

The display pipe selected by the LVDS display port is programmed with the panel timing parameters that are determined by installed panel specifications or read from an onboard EDID ROM. The programmed timing values are then 'locked' into the registers to prevent unwanted corruption of the values. From that point on, the display modes are changed by selecting a different source size for that pipe, programming the VGA registers, or selecting a source size and enabling the VGA.

The LVDS DDC helps to reads the panel timing parameters or panel EDID.

5.26.2.2 High Definition Multimedia Interface

The High-Definition Multimedia Interface (HDMI) is provided for transmitting uncompressed digital audio and video signals from DVD players, set-top boxes and other audiovisual sources to television sets, projectors and other video displays. It can carry high quality multi-channel audio data and all standard and high-definition consumer electronics video formats. HDMI display interface connecting the PCH and display devices utilizes transition minimized differential signaling (TMDS) to carry audiovisual information through the same HDMI cable.

HDMI includes three separate communications channels: TMDS, DDC, and the optional CEC (consumer electronics control) (not supported by the PCH). As shown in [Figure 5-17](#) the HDMI cable carries four differential pairs that make up the TMDS data and clock channels. These channels are used to carry video, audio, and auxiliary data. In addition, HDMI carries a VESA DDC. The DDC is used by an HDMI Source to determine the capabilities and characteristics of the Sink.

Audio, video and auxiliary (control/status) data is transmitted across the three TMDS data channels. The video pixel clock is transmitted on the TMDS clock channel and is used by the receiver for data recovery on the three data channels. The digital display data signals driven natively through the PCH are AC coupled and needs level shifting to convert the AC coupled signals to the HDMI compliant digital signals.

PCH HDMI interface is designed as per High-Definition Multimedia Interface Specification 1.4a. The PCH supports High-Definition Multimedia Interface Compliance Test Specification 1.4a.

Figure 5-17. HDMI Overview

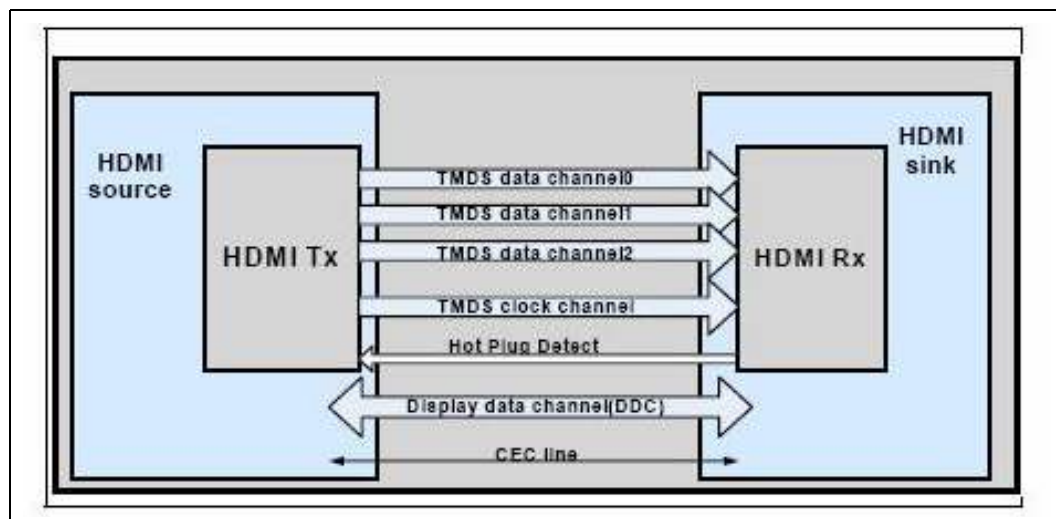



5.26.2.3 Digital Video Interface (DVI)

The PCH Digital Ports can be configured to drive DVI-D. DVI uses TMDS for transmitting data from the transmitter to the receiver which is similar to the HDMI protocol but the audio and CEC. Refer to the HDMI section for more information on the signals and data transmission. To drive DVI-I through the back panel the VGA DDC signals is connected along with the digital data and clock signals from one of the Digital Ports. When a system has support for a DVI-I port, then either VGA or the DVI-D through a single DVI-I connector can be driven but not both simultaneously.

The digital display data signals driven natively through the PCH are AC coupled and needs level shifting to convert the AC coupled signals to the HDMI compliant digital signals.

5.26.2.4 DisplayPort*

DisplayPort is a digital communication interface that utilizes differential signaling to achieve a high bandwidth bus interface designed to support connections between PCs and monitors, projectors, and TV displays. DisplayPort is also suitable for display connections between consumer electronics devices such as high definition optical disc players, set top boxes, and TV displays.

A DisplayPort consists of a Main Link, Auxiliary channel, and a Hot Plug Detect signal. The Main Link is a uni-directional, high-bandwidth, and low latency channel used for transport of isochronous data streams such as uncompressed video and audio. The Auxiliary Channel (AUX CH) is a half-duplex bidirectional channel used for link management and device control. The Hot Plug Detect (HPD) signal serves as an interrupt request for the sink device.

PCH is designed as per VESA DisplayPort Standard Version 1.1a. The PCH supports VESA DisplayPort* PHY Compliance Test Specification 1.1 and VESA DisplayPort* Link Layer Compliance Test Specification 1.1.

Figure 5-18. DisplayPort Overview

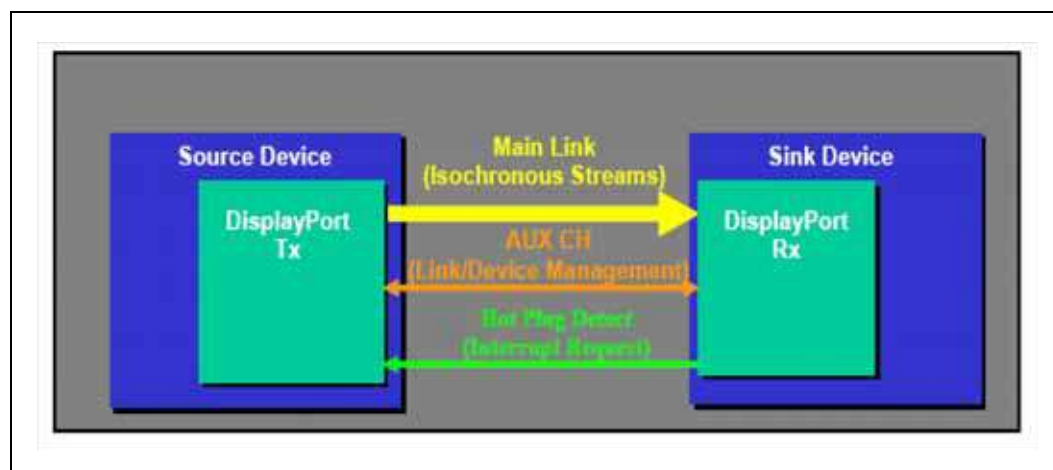

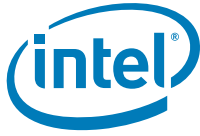

5.26.2.5 Embedded DisplayPort

Embedded DisplayPort (eDP*) is an embedded version of the DisplayPort standard oriented towards applications such as notebook and All-In-One PCs. eDP is supported only on Digital Port D. Like DisplayPort, Embedded DisplayPort also consists of a Main Link, Auxiliary channel, and an optional Hot Plug Detect signal.

The eDP support on desktop PCH is possible because of the addition of the panel power sequencing pins: L_VDD, L_BKLT_EN and L_BKLT_CTRL. The eDP on the PCH can be configured for 2 or 4 lanes.

PCH supports Embedded DisplayPort* (eDP*) Standard Version 1.1.

5.26.2.6 DisplayPort Aux Channel

A bi-directional AC coupled AUX channel interface replaces the I2C for EDID read, link management and device control. I²C-to-Aux bridges are required to connect legacy display devices.

5.26.2.7 DisplayPort Hot-Plug Detect (HPD)

The PCH supports HPD for Hot-Plug sink events on the HDMI and DisplayPort interface.

5.26.2.8 Integrated Audio over HDMI and DisplayPort

DisplayPort and HDMI interfaces on PCH support audio. [Table 5-59](#) shows the supported audio technologies on the PCH.

Table 5-59. PCH Supported Audio Formats over HDMI and DisplayPort*

Audio Formats	HDMI	DisplayPort
AC-3 - Dolby* Digital	Yes	No
Dolby Digital Plus	Yes	No
DTS-HD*	Yes	No
LPCM, 192 kHz/24 bit, 8 Channel	Yes	Yes (two channel - up to 96 kHz 24 bit)
Dolby TrueHD, DTS-HD Master Audio* (Losses Blu-ray Disc* Audio Format)	Yes	No

PCH will continue to support Silent stream. Silent stream is an integrated audio feature that enables short audio streams such as system events to be heard over the HDMI and DisplayPort monitors. PCH supports silent streams over the HDMI and DisplayPort interfaces at 44.1 kHz, 48 kHz, 88.2 kHz, 96 kHz, 176.4 kHz and 192 kHz sampling rates.

5.26.2.9 Serial Digital Video Out (SDVO)

Serial Digital Video Out (SDVO) sends display data in serialized format which then can be converted into appropriate display protocol using a SDVO device. Serial Digital Video Out (SDVO) supports SDVO-LVDS only on the PCH. Though the SDVO electrical interface is based on the PCI Express interface, the protocol and timings are completely unique. The PCH utilizes an external SDVO device to translate from SDVO protocol and timings to the desired display format and timings.

SDVO is supported only on Digital Port B of the PCH.



Figure 5-19. SDVO Conceptual Block Diagram

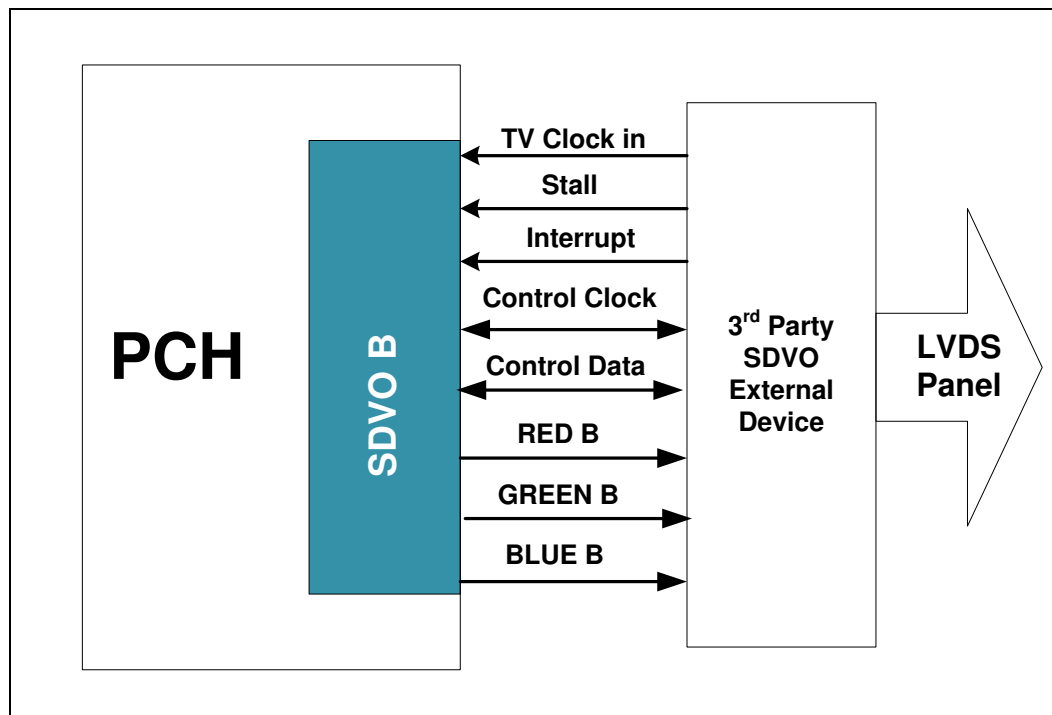

5.26.2.9.1 Control Bus

Communication to SDVO registers and if utilized, ADD2 PROMs and monitor DDCs, are accomplished by using the SDVOCTRLDATA and SDVOCTRLCLK signals through the SDVO device. These signals run up to 400 kHz and connect directly to the SDVO device.

The SDVO device is then responsible for routing the DDC and PROM data streams to the appropriate location. Consult SDVO device data sheets for level shifting requirements of these signals.

5.26.3 Mapping of Digital Display Interface Signals

Table 5-60. PCH Digital Port Pin Mapping

Port Description	DisplayPort* Signals	HDMI* Signals	SDVO Signals	PCH Display Port Pin details
Port B	DPB_LANE3	TMDSB_CLK	SDVOB_CLK	DDPB_[3]P
	DPB_LANE3#	TMDSB_CLKB	SDVOB_CLK#	DDPB_[3]N
	DPB_LANE2	TMDSB_DATA0	SDVOB_BLUE	DDPB_[2]P
	DPB_LANE2#	TMDSB_DATA0B	SDVOB_BLUE#	DDPB_[2]N
	DPB_LANE1	TMDSB_DATA1	SDVOB_GREEN	DDPB_[1]P
	DPB_LANE1#	TMDSB_DATA1B	SDVOB_GREEN#	DDPB_[1]N
	DPB_LANE0	TMDSB_DATA2	SDVOB_RED	DDPB_[0]P
	DPB_LANE0#	TMDSB_DATA2B	SDVOB_RED*	DDPB_[0]N
	DPB_HPD	TMDSB_HPD		DDPB_HPD
	DPB_AUX			DDPB_AUXP
	DPB_AUXB			DDPB_AUXN
Port C	DPC_LANE3	TMDSC_CLK		DDPC_[3]P
	DPC_LANE3#	TMDSC_CLKB		DDPC_[3]N
	DPC_LANE2	TMDSC_DATA0		DDPC_[2]P
	DPC_LANE2#	TMDSC_DATA0B		DDPC_[2]N
	DPC_LANE1	TMDSC_DATA1		DDPC_[1]P
	DPC_LANE1#	TMDSC_DATA1B		DDPC_[1]N
	DPC_LANE0	TMDSC_DATA2		DDPC_[0]P
	DPC_LANE0#	TMDSC_DATA2B		DDPC_[0]N
	DPC_HPD	TMDSC_HPD		DDPC_HPD
	DPC_AUX			DDPC_AUXP
	DPC_AUXC			DDPC_AUXN
Port D	DPD_LANE3	TMDSD_CLK		DDPD_[3]P
	DPD_LANE3#	TMDSD_CLKB		DDPD_[3]N
	DPD_LANE2	TMDSD_DATA0		DDPD_[2]P
	DPD_LANE2#	TMDSD_DATA0B		DDPD_[2]N
	DPD_LANE1	TMDSD_DATA1		DDPD_[1]P
	DPD_LANE1#	TMDSD_DATA1B		DDPD_[1]N
	DPD_LANE0	TMDSD_DATA2		DDPD_[0]P
	DPD_LANE0#	TMDSD_DATA2B		DDPD_[0]N
	DPD_HPD	TMDSD_HPD		DDPD_HPD
	DPD_AUX			DDPD_AUXP
	DPD_AUXD			DDPD_AUXN



5.26.4 Multiple Display Configurations

The following multiple display configuration modes are supported (with appropriate driver software):

- Single Display is a mode with one display port activated to display the output to one display device.
- Intel® Dual Display Clone is a mode with two display ports activated to drive the display content of same color depth setting but potentially different refresh rate and resolution settings to all the active display devices connected.
- Extended Desktop is a mode with two display ports activated used to drive the content with potentially different color depth, refresh rate, and resolution settings on each of the active display devices connected.

Table 5-61 describes the valid interoperability between display technologies.

Table 5-61. Display Co-Existence Table

Display	Not Attached	DAC	Integrated LVDS	Integrated DisplayPort*	HDMI*/DVI	eDP*
		VGA				
Not Attached	X	S	S	S	S	S
DAC VGA	S	X	S ¹ , C, E	A	A	S ¹ , C, E
Integrated LVDS	S	S ¹ , C, E	X	S ¹ , C, E	S ¹ , C, E	X
Integrated DisplayPort	S	A	S ¹ , C, E	A	A	S ¹ , C, E
HDMI/DVI	S	A	S ¹ , C, E	A	S ¹ , C, E	S ¹ , C, E
SDVO LVDS	S	S ¹ , C, E	S ¹ , C, E	S ¹ , C, E	S ¹ , C, E	A
eDP	S	S ¹ , C, E	X	S ¹ , C, E	S ¹ , C, E	X

• A = Single Pipe Single Display, Intel® Dual Display Clone (Only 24-bpp), or Extended Desktop Mode
 • C = Clone Mode
 • E = Extended Desktop Mode
 • S = Single Pipe Single Display
 • S¹ = Single Pipe Single Display With One Display Device Disabled
 • X = Unsupported/Not Applicable

5.26.5 High-bandwidth Digital Content Protection (HDCP)

HDCP is the technology for protecting high definition content against unauthorized copy or unreceptive between a source (computer, digital set top boxes, etc.) and the sink (panels, monitor, and TVs). The PCH supports HDCP 1.4 for content protection over wired displays (HDMI, DVI, and DisplayPort).

The HDCP 1.4 keys are integrated into the PCH and customers are not required to physically configure or handle the keys.



5.26.6 Intel® Flexible Display Interconnect

Intel® FDI connects the display engine in the processor with the display interfaces on the PCH. The display data from the frame buffer is processed in the display engine of the processor and sent to the PCH over the Intel FDI where it is transcoded as per the display protocol and driven to the display monitor.

Intel FDI has two channels A and B. Each channel has 4 lanes and total combined is 8 lanes to transfer the data from the processor to the PCH. Depending on the data bandwidth the interface is dynamically configured as x1, x2 or x4 lanes. Intel FDI supports lane reversal and lane polarity reversal.

5.27 Intel® Virtualization Technology

Intel Virtualization Technology (Intel® VT) makes a single system appear as multiple independent systems to software. This allows for multiple, independent operating systems to be running simultaneously on a single system. Intel VT comprises technology components to support virtualization of platforms based on Intel architecture microprocessors and chipsets. The first revision of this technology (Intel VT-x) added hardware support in the processor to improve the virtualization performance and robustness. The second revision of this specification (Intel VT-d) adds chipset hardware implementation to improve I/O performance and robustness.

The Intel VT-d specification and other VT documents can be referenced here: <http://www.intel.com/technology/platform-technology/virtualization/index.htm>

5.27.1 Intel® VT-d Objectives

The key Intel VT-d objectives are domain based isolation and hardware based virtualization. A domain can be abstractly defined as an isolated environment in a platform to which a subset of host physical memory is allocated. Virtualization allows for the creation of one or more partitions on a single system. This could be multiple partitions in the same OS or there can be multiple operating system instances running on the same system offering benefits such as system consolidation, legacy migration, activity partitioning or security.

5.27.2 Intel® VT-d Features Supported

- The following devices and functions support FLR in the PCH:
 - High Definition Audio (Device 27: Function 0)
 - SATA Host Controller 1 (Device 31: Function 2)
 - SATA Host Controller 2 (Device 31: Function 5)
 - USB2 (EHCI) Host Controller 1 (Device 29: Function 0)
 - USB2 (EHCI) Host Controller 2 (Device 26: Function 0)
 - GbE Lan Host Controller (Device 25: Function 0)
- Interrupt virtualization support for IOxAPIC
- Virtualization support for HPETs



5.27.3 Support for Function Level Reset (FLR) in PCH

Intel VT-d allows system software (VMM/OS) to assign I/O devices to multiple domains. The system software, then, requires ways to reset I/O devices or their functions within, as it assigns/re-assigns I/O devices from one domain to another. The reset capability is required to ensure the devices have undergone proper re-initialization and are not keeping the stale state. A standard ability to reset I/O devices is also useful for the VMM in case where a guest domain with assigned devices has become unresponsive or has crashed.

PCI Express defines a form of device hot reset which can be initiated through the Bridge Control register of the root/switch port to which the device is attached. However, the hot reset cannot be applied selectively to specific device functions. Also, no similar standard functionality exists for resetting root-complex integrated devices.

Current reset limitations can be addressed through a *function level reset* (FLR) mechanism that allows software to independently reset specific device functions.

5.27.4 Virtualization Support for PCH's IOxAPIC

The Intel VT-d architecture extension requires Interrupt Messages to go through the similar Address Remapping as any other memory requests. This is to allow domain isolation for interrupts such that a device assigned in one domain is not allowed to generate interrupts to another domain.

The Address Remapping for Intel VT-d is based on the Bus:Device:Function field associated with the requests. Hence, it is required for the internal IOxAPIC to initiate the Interrupt Messages using a unique Bus:Device:Function.

The PCH supports BIOS programmable unique Bus:Device:Function for the internal IOxAPIC. The Bus:Device:Function field does not change the IOxAPIC functionality in anyway, nor promoting IOxAPIC as a stand-alone PCI device. The field is only used by the IOxAPIC in the following:

- As the Requestor ID when initiating Interrupt Messages to the processor
- As the Completer ID when responding to the reads targeting the IOxAPIC's Memory-Mapped I/O registers

5.27.5 Virtualization Support for High Precision Event Timer (HPET)

The Intel VT-d architecture extension requires Interrupt Messages to go through the similar Address Remapping as any other memory requests. This is to allow domain isolation for interrupts such that a device assigned in one domain is not allowed to generate interrupts to another domain.

The Address Remapping for Intel VT-d is based on the Bus:Device:Function field associated with the requests. Hence, it is required for the HPET to initiate the direct FSB Interrupt Messages using unique Bus:Device:Function.

The PCH supports BIOS programmable unique Bus:Device:Function for each of the HPET timers. The Bus:Device:Function field does not change the HPET functionality in anyway, nor promoting it as a stand-alone PCI device. The field is only used by the HPET timer in the following:

- As the Requestor ID when initiating direct interrupt messages to the processor
- As the Completer ID when responding to the reads targeting its Memory-Mapped registers
- The registers for the programmable Bus:Device:Function for HPET timer 7:0 reside under the Device 31:Function 0 LPC Bridge's configuration space.







6 Ballout Definition

This chapter contains the PCH Ballout information.

6.1 Desktop PCH Ballout

This section contains the Desktop PCH ballout. Figure 6-1, Figure 6-2, Figure 6-3, and Figure 6-4 show the ballout from a top of the package quadrant view. Table 6-1 is the BGA ball list, sorted alphabetically by signal name.

Note: References to PWM[3:0], TACH[7:0], SST, NMI#, SMI# are for Server/Workstation SKUs only. Pin names PWM[3:0], TACH[7:0], SST, NMI#, SMI# are Reserved on Desktop SKUs. See Chapter 2 for further details.

Figure 6-1. Desktop PCH Ballout (Top View - Upper Left)

	BU	BT	BR	BP	BN	BM	BL	BK	BJ	BH	BG	BF	BE	BD	BC	BB	BA	AY	AW	AV	AU	AT	AR	AP	AN	AM	AL	AK
1				VSS_NCTF	VSS_NCTF							V5REP							CRT_DDC_DATA		VccADAC				CRT_BLIU_E			
2		VSS_NCTF		AD14		AD21				C/BE2#	GNT3#/GPIO55		AD24		CLKOUTF_LEX3/GPIO67			VccADAC		CRT_VSY_NC			CRT_GRE_EN			ADCLK_RC_OMP		
3					PERR#		AD9			AD13									CRT_DDC_CLK			DAC_REF						
4				PIROH#/GPIO5	C/BE0#		AD23					AD15		AD22									CRT_HSY_NC					
5				REQ1#/GPIO50	PIROD#				PIROB#		REQ0#				CLKOUTF_LEX1/GPIO65				CLKOUTF_LEX2/GPIO66								VccACK	
6				SERR#				Vss		Vss		AD16		AD18											CRT_RED	CRT_IRTN		
7				AD2		C/BE1#																						
8							AD12	REQ2#/GPIO52		PAR		AD29		TRDY#		AD28			GNT1#/GPIO51		Vss			REFCLK14_IN		DDPC_CT_RLCLK		
9		AD7		AD10	PIROE#/GPIO2					DEVSEL#		AD27			Vss		AD26		PIROF#/GPIO3				CLKOUTF_LEX0/GPIO64				DDPC_CT_RLCLK	
10						Vss		PIROA#	AD11																			
11				AD19		AD5							IRDY#		FRAME#				REQ3#/GPIO54				CLKOUTF_PC0					
12		GNT2#/GPIO53		AD8				AD31	AD6		AD4				STOP#								CLKOUTF_PC2			Vss	DDPC_CT_RLCLK	
13			AD3		C/BE3#		AD25																					
14															Vss		AD20		PCIRST#				CLKOUTF_PC4			CLKOUTF_PC1	DDPC_CT_RLCLK	
15			PIROG#/GPIO4		TACH7#/GPIO71		PIROC#	FWH0/LAD0			AD17	AD0		CLKIN_PCI_LOOPBACK			GNT0#		PME#								SDVO_CT_RLCLK	
16		TACH4#/GPIO68		TACH3#/GPIO7																								
17			TACH0#/GPIO17			TACH6#/GPIO70		LDRQ#	FWH1/LAD1		FWH4/LFRAME#	AD1		Vcc3_3	Vcc3_3		FLOCK#		AD30				CLKOUTF_PC3				SDVO_CT_RLCLK	
18						TACH5#/GPIO69																						
19			TACH1#/GPIO1		Vss																							
20								FWH2/LAD2		FWH3/LAD3				Vcc3_3			LDRO1#/GPIO23	NC_1		Vcc3_3	Vcc3_3				Vss			
21																												
22		HDA_BCLK						HDA_SDN2	HDA_SDN3			HDA_SDN1		HDA_SDN0	HDA_RST#		TACH2#/GPIO6	Vss			Vcc3_3		Vss		VccASW			
23			HDA_SDO		HDA_SYN_C																							
24																												
25			VREF_S#		USBRBIAS#		USBRBIAS	USBP10N	USBP10P						HDA_DOC_K_EN#/GPIO33		HDA_DOC_K_RST#/GPIO13		VccD								VccASW	
26				USBP9N																								VccASW
27			USBP9P			USBP9N		USBP13P	USBP13N			USBP12N		USBP12P			TP11	VccD										VccASW
28																												VccASW

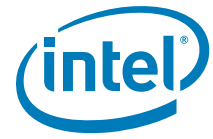

Figure 3-3. Desktop PCH Ballout (Top View - Upper Right)

	AJ	AH	AG	AF	AE	AD	AC	AB	AA	Y	W	V	U	T	R	P	N	M	L	K	J	H	G	F	E	D	C	B	A
1	VccITM			CLKOUT_PClEP			VccADPLL_A						DDPB_HP_D				DDPD_HP_D							VSS_NCT_F	VSS_NCT_F				
2		CLKOUT_PClESP	CLKOUT_PClE7N		VccADPLL_B	CLKOUT_PClE6N		CLKOUT_PClE6P				SDVO_INT_P	VccVMM	DDPC_HP_D		DDPC_0P							DDPC_1P	DDPC_3N			VSS_NCT_F		
3	XTAL29_N		CLKOUT_PClE5N				CLKOUT_PClE4N				SDVO_ST_ALLP		SDVO_INT_N			DDPB_3N						DDPC_0N	DDPC_2P						
4																							DDPC_1N	DDPC_3P			VSS_NCT_F		
5	XTAL29_0_UT						CLKOUT_PClE1N	CLKOUT_PClE1P			SDVO_ST_ALLN					DDPB_3P							DDPC_2N	DDPD_0P	DDPD_0N				
6				CLKOUT_PClE0N			CLKOUT_PClE0P						DDPD_AU_XN	DDPD_AU_XP			Yes									DDPD_1N	DDPD_2P	VSS_NCT_F	
7																													
8		CLKOUT_PEG_A_N					CLKOUT_PClE3P	CLKOUT_PClE4P			SDVO_TV_CLKNP	DDPB_AU_XP					DDPB_2N	DDPB_2P											
9		CLKOUT_PEG_A_P					CLKOUT_PClE3N	CLKOUT_PClE4N			SDVO_TV_CLKNN	DDPB_AU_XN											Yes		DDPD_2N				
10																				PERp8	PERn8								
11			CLKOUT_PEG_B_P														DDPB_1P							DDPD_3P		DDPD_3N			
12		L_BKLTCTL	CLKOUT_PEG_B_N				CLKOUT_PClE2N	TP20				DDPC_AU_XN	DDPB_0N			DDPB_1N				PERn7	PERp7						Vcc3_1		
13																									PETp7	PETp8	PETn8		
14							CLKOUT_PClE2P	TP19				DDPC_AU_XP	DDPB_0P																
15		VccDIFFC_LKN	VccDIFFC_LKN													PERn5	PERp5	PERp6					PERn6		PETn7			PETp6	
16																											PETp5	PETn6	
17		L_VDDEN	VccDIFFC_LKN				TP9	TP7							PERn4	PERp4						PERp3	PERn3		PETp4		PETn5		
18		L_BKLTEN					TP8	TP6																PETn4					
19																												VccAPLL_M2	
20	VccDIRM_I			VccSSC	VccSSC			VccIO						PERp2	PERn2			PERp1		PERn1			VccIO						
21																								PETn3		PETp3			
22								VccIO				VccIO			TP1			TP24		TP28						PETn2	PETp2		
23																								PETp1					
24	VccASW	VccASW	VccCore	VccCore				VccIO																					
25								VccIO			Yes	Yes					TP27		TP23					PETn1		TP36		TP32	
26	VccASW	VccASW		VccCore				VccIO																			TP31		
27													CLKIN_ONCLKIN_ON_D1_N	CLKIN_ONCLKIN_ON_D1_P														TP35	
28	VccASW	VccASW	VccCore	VccCore				VccIO																TP30					



Table 6-1. Desktop PCH Ballout By Signal Name

Desktop PCH Ball Map	Ball #	Desktop PCH Ball Map	Ball #	Desktop PCH Ball Map	Ball #
A20GATE	BB57	CLKIN_DOT_96N	BD38	CLKOUTFLEX3 / GPIO67	BA2
AD0	BF15	CLKIN_DOT_96P	BF38	CLKRUN# / GPIO32	BC56
AD1	BF17	CLKIN_GND0_N	W53	CRT_BLUE	AM1
AD2	BT7	CLKIN_GND0_P	V52	CRT_DDC_CLK	AW3
AD3	BT13	CLKIN_GND1_N	R27	CRT_DDC_DATA	AW1
AD4	BG12	CLKIN_GND1_P	P27	CRT_GREEN	AN2
AD5	BN11	CLKIN_PCILoopBACK	BD15	CRT_HSYNC	AR4
AD6	BJ12	CLKIN_SATA_N	AF55	CRT_IRTN	AM6
AD7	BU9	CLKIN_SATA_P	AG56	CRT_RED	AN6
AD8	BR12	CLKOUT_DMI_N	P31	CRT_VSYNC	AR2
AD9	BJ3	CLKOUT_DMI_P	R31	DAC_IREF	AT3
AD10	BR9	CLKOUT_DP_N	N56	DcpRTC	BR54
AD11	BJ10	CLKOUT_DP_P	M55	DcpRTC_NCTF	BT56
AD12	BM8	CLKOUT_ITPXD_P_N	R52	DcpSST	BA46
AD13	BF3	CLKOUT_ITPXD_P_P	N52	DcpSus	AA32
AD14	BN2	CLKOUT_PCI0	AT11	DcpSus	AT41
AD15	BE4	CLKOUT_PCI1	AN14	DcpSus	A39
AD16	BE6	CLKOUT_PCI2	AT12	DcpSusByp	AV41
AD17	BG15	CLKOUT_PCI3	AT17	DDPB_ON	R12
AD18	BC6	CLKOUT_PCI4	AT14	DDPB_OP	R14
AD19	BT11	CLKOUT_PCIE0N	AE6	DDPB_1N	M12
AD20	BA14	CLKOUT_PCIE0P	AC6	DDPB_1P	M11
AD21	BL2	CLKOUT_PCIE1N	AA5	DDPB_2N	K8
AD22	BC4	CLKOUT_PCIE1P	W5	DDPB_2P	H8
AD23	BL4	CLKOUT_PCIE2N	AB12	DDPB_3N	M3
AD24	BC2	CLKOUT_PCIE2P	AB14	DDPB_3P	L5
AD25	BM13	CLKOUT_PCIE3N	AB9	DDPB_AUXN	R9
AD26	BA9	CLKOUT_PCIE3P	AB8	DDPB_AUXP	R8
AD27	BF9	CLKOUT_PCIE4N	Y9	DDPB_HPDP	T1
AD28	BA8	CLKOUT_PCIE4P	Y8	DDPC_ON	J3
AD29	BF8	CLKOUT_PCIE5N	AF3	DDPC_OP	L2
AD30	AV17	CLKOUT_PCIE5P	AG2	DDPC_1N	G4
AD31	BK12	CLKOUT_PCIE6N	AB3	DDPC_1P	G2
APWROK	BC46	CLKOUT_PCIE6P	AA2	DDPC_2N	F5
BATLOW# / GPIO72	AV46	CLKOUT_PCIE7N	AE2	DDPC_2P	F3
BMBUSY# / GPIO0	AW55	CLKOUT_PCIE7P	AF1	DDPC_3N	E2
C/BE0#	BN4	CLKOUT_PEG_A_N	AG8	DDPC_3P	E4
C/BE1#	BP7	CLKOUT_PEG_A_P	AG9	DDPC_AUXN	U12
C/BE2#	BG2	CLKOUT_PEG_B_N	AE12	DDPC_AUXP	U14
C/BE3#	BP13	CLKOUT_PEG_B_P	AE11	DDPC_CTRLCLK	AL12
CL_CLK1	BA50	CLKOUTFLEX0 / GPIO64	AT9	DDPC_CTRLDATA	AL14
CL_DATA1	BF50	CLKOUTFLEX1 / GPIO65	BA5	DDPC_HPDP	N2
CL_RST1#	BF49	CLKOUTFLEX2 / GPIO66	AW5	DDPD_ON	B5
CLKIN_DMI_N	P33			DDPD_OP	D5
CLKIN_DMI_P	R33			DDPD_1N	D7



Desktop PCH Ball Map	Ball #	Desktop PCH Ball Map	Ball #	Desktop PCH Ball Map	Ball #
DDPD_1P	C6	FDI_RXP0	B43	L_BKLTEN	AG18
DDPD_2N	C9	FDI_RXP1	F43	L_VDD_EN	AG17
DDPD_2P	B7	FDI_RXP2	J41	LAN_PHY_PWR_CTRL/ GPIO12	BK50
DDPD_3N	B11	FDI_RXP3	D47	LDRQ0#	BK17
DDPD_3P	E11	FDI_RXP4	A46	LDRQ1# / GPIO23	BA20
DDPD_AUXN	R6	FDI_RXP5	C49	TS_VSS1	A54
DDPD_AUXP	N6	FDI_RXP6	H43	TS_VSS2	A52
DDPD_CTRLCLK	AL9	FDI_RXP7	P43	TS_VSS3	F57
DDPD_CTRLDATA	AL8	FRAME#	BC11	TS_VSS4	D57
DDPD_HPD	M1	FWH0 / LAD0	BK15	NC_1	AY20
DEVSEL#	BH9	FWH1 / LAD1	BJ17	Reserved	M48
DMI_IRCOMP	B31	FWH2 / LAD2	BJ20	Reserved	K50
DMI_ZCOMP	E31	FWH3 / LAD3	BG20	Reserved	K49
DMIORXN	D33	FWH4 / LFRAME#	BG17	Reserved	AB46
DMIORXP	B33	GNT0#	BA15	Reserved	G56
DMI0TXN	J36	GNT1# / GPIO51	AV8	DF_TV5	R47
DMI0TXP	H36	GNT2# / GPIO53	BU12	Reserved	AB50
DMI1RXN	A36	GNT3# / GPIO55	BE2	Reserved	Y50
DMI1RXP	B35	GPIO15	BM55	Reserved	AB49
DMI1TXN	P38	GPIO24 / PROC_MISSING	BP53	Reserved	AB44
DMI1TXP	R38	GPIO27	BJ43	Reserved	U49
DMI2RBIAS	A32	GPIO28	BJ55	Reserved	R44
DMI2RXN	B37	GPIO31	BG43	Reserved	U50
DMI2RXP	C36	GPIO35 / NMI#	BJ57	Reserved	U46
DMI2TXN	H38	GPIO57	BT53	Reserved	U44
DMI2TXP	J38	GPIO8	BP51	Reserved	H50
DMI3RXN	E37	HDA_BCLK	BU22	Reserved	K46
DMI3RXP	F38	HDA_DOCK_EN# / GPIO33	BC25	Reserved	L56
DMI3TXN	M41	HDA_DOCK_RST# / GPIO13	BA25	Reserved	J55
DMI3TXP	P41	HDA_RST#	BC22	Reserved	F53
DPWROK	BT37	HDA_SDIN0	BD22	Reserved	H52
DRAMPWROK	BG46	HDA_SDIN1	BF22	Reserved	E52
DSWVRMEN	BR42	HDA_SDIN2	BK22	Reserved	Y44
FDI_FSYNC0	B51	HDA_SDIN3	BJ22	Reserved	L53
FDI_FSYNC1	C52	HDA_SDO	BT23	Reserved	Y41
FDI_INT	H46	HDA_SYNC	BP23	Reserved	R50
FDI_LSYNC0	E49	INIT3_3V#	BN56	Reserved	M50
FDI_LSYNC1	D51	INTRUDER#	BM38	Reserved	M49
FDI_RXN0	C42	INTVRMEN	BN41	Reserved	U43
FDI_RXN1	F45	IRDY#	BF11	Reserved	J57
FDI_RXN2	H41	JTAG_TCK	BA43	OC0# / GPIO59	BM43
FDI_RXN3	C46	JTAG_TDI	BC52	OC1# / GPIO40	BD41
FDI_RXN4	B45	JTAG_TDO	BF47	OC2# / GPIO41	BG41
FDI_RXN5	B47	JTAG_TMS	BC50	OC3# / GPIO42	BK43
FDI_RXN6	J43	L_BKLTCTL	AG12	OC4# / GPIO43	BP43
FDI_RXN7	M43			OC5# / GPIO9	BJ41



Desktop PCH Ball Map	Ball #	Desktop PCH Ball Map	Ball #	Desktop PCH Ball Map	Ball #
OC6# / GPIO10	BT45	PIRQC#	BM15	SATA3RCOMPO	AE52
OC7# / GPIO14	BM45	PIRQD#	BP5	SATA3RXN	AN46
PAR	BH8	PIRQE# / GPIO2	BN9	SATA3RXP	AN44
PCIECLKRQ2# / GPIO20 / SMI#	AV43	PIRQF# / GPIO3	AV9	SATA3TXN	AN56
PCIECLKRQ5# / GPIO44	BL54	PIRQG# / GPIO4	BT15	SATA3TXP	AM55
PCIECLKRQ6# / GPIO45	AV44	PIRQH# / GPIO5	BR4	SATA4GP / GPIO16	AU56
PCIECLKRQ7# / GPIO46	BP55	PLOCK#	BA17	SATA4RXN	AN49
PCIRST#	AV14	PLTRST#	BK48	SATA4RXP	AN50
PECI	H48	PME#	AV15	SATA4TXN	AT50
PERn1	J20	PMSYNCH	F55	SATA4TXP	AT49
PERn2	P20	PROCPWRGD	D53	SATA5GP / GPIO49 / THERM_ALERT#	BA56
PERn3	H17	PWM0	BN21	SATA5RXN	AT46
PERn4	P17	PWM1	BT21	SATA5RXP	AT44
PERn5	N15	PWM2	BM20	SATA5TXN	AV50
PERn6	J15	PWM3	BN19	SATA5TXP	AV49
PERn7	J12	PWRBTN#	BT43	SATAICOMPI	AJ55
PERn8	H10	PWROK	BJ38	SATAICOMPO	AJ53
PERp1	L20	RCIN#	BG56	SATALED#	BF57
PERp2	R20	REFCLK14IN	AN8	SCLOCK / GPIO22	BA53
PERp3	J17	REQ0#	BG5	SDATAOUT0 / GPIO39	BF55
PERp4	M17	REQ1# / GPIO50	BT5	SDATAOUT1 / GPIO48	AW53
PERp5	M15	REQ2# / GPIO52	BK8	SDVO_CTRLCLK	AL15
PERp6	L15	REQ3# / GPIO54	AV11	SDVO_CTRLDATA	AL17
PERp7	H12	RI#	BJ48	SDVO_INTN	T3
PERp8	J10	RSMRST#	BK38	SDVO_INTP	U2
PERR#	BM3	RTCST#	BT41	SDVO_STALLN	U5
PETn1	F25	RTCX1	BR39	SDVO_STALLP	W3
PETn2	C22	RTCX2	BN39	SDVO_TVCLKINN	U9
PETn3	E21	SATA0GP / GPIO21	BC54	SDVO_TVCLKINP	U8
PETn4	F18	SATA0RXN	AC56	SERIRQ	AV52
PETn5	B17	SATA0RXP	AB55	SERR#	BR6
PETn6	A16	SATA0TXN	AE46	SLOAD / GPIO38	BE54
PETn7	F15	SATA0TXP	AE44	SLP_A#	BC41
PETn8	B13	SATA1GP / GPIO19	AY52	SLP_LAN# / GPIO29	BH49
PETp1	F23	SATA1RXN	AA53	SLP_S3#	BM53
PETp2	A22	SATA1RXP	AA56	SLP_S4#	BN52
PETp3	B21	SATA1TXN	AG49	SLP_S5# / GPIO63	BH50
PETp4	E17	SATA1TXP	AG47	SLP_SUS#	BD43
PETp5	C16	SATA2GP / GPIO36	BB55	SMBALERT# / GPIO11	BN49
PETp6	B15	SATA2RXN	AL50	SMBCLK	BT47
PETp7	F13	SATA2RXP	AL49	SMBDATA	BR49
PETp8	D13	SATA2TXN	AL56	SML0ALERT# / GPIO60	BU49
PIRQA#	BK10	SATA2TXP	AL53	SML0CLK	BT51
PIRQB#	BJ5	SATA3COMPI	AE54	SML0DATA	BM50
		SATA3GP / GPIO37	BG53		
		SATA3RBIAS	AC52		



Desktop PCH Ball Map	Ball #	Desktop PCH Ball Map	Ball #	Desktop PCH Ball Map	Ball #
SML1ALERT# / PCHHOT# / GPIO74	BR46	TP18	AY36	USBP13N	BJ27
SML1CLK / GPIO58	BJ46	TP19	Y14	USBP13P	BK27
SML1DATA / GPIO75	BK46	TP20	Y12	USBRBIAS	BM25
SPI_CLK	AR54	TP21	H31	USBRBIAS#	BP25
SPI_CS0#	AT57	TP22	J27	V_PROC_IO	D55
SPI_CS1#	AR56	TP23	J25	V_PROC_IO_NCTF	B56
SPI_MISO	AT55	TP24	L22	V5REF	BF1
SPI_MOSI	AU53	TP25	J31	V5REF_Sus	BT25
SPKR	BE56	TP26	L27	Vcc3_3	AF57
SRTCST#	BN37	TP27	L25	Vcc3_3	BC17
SST	BC43	TP28	J22	Vcc3_3	BD17
STOP#	BC12	TP29	C29	Vcc3_3	BD20
STP_PCI# / GPIO34	BL56	TP30	F28	Vcc3_3	AL38
SUS_STAT# / GPIO61	BN54	TP31	C26	Vcc3_3	AN38
SUSACK#	BP45	TP32	B25	Vcc3_3	AU22
SUSCLK / GPIO62	BA47	TP33	E29	Vcc3_3	A12
SUSWARN# / SUSPWRDNACK / GPIO30	BU46	TP34	E27	Vcc3_3	AU20
SYS_PWROK	BJ53	TP35	B27	Vcc3_3	AV20
SYS_RESET#	BE52	TP36	D25	VccAClk	AL5
TACH0 / GPIO17	BT17	TRDY#	BC8	VccADAC	AT1
TACH1 / GPIO1	BR19	USBP0N	BF36	VccADPLL	AB1
TACH2 / GPIO6	BA22	USBP0P	BD36	VccADPLL	AC2
TACH3 / GPIO7	BR16	USBP1N	BC33	VccAFDIPLL	C54
TACH4 / GPIO68	BU16	USBP1P	BA33	VccAPLLDMI2	A19
TACH5 / GPIO69	BM18	USBP2N	BM33	VccAPLLEXP	B53
TACH6 / GPIO70	BN17	USBP2P	BM35	VccAPLLSATA	U56
TACH7 / GPIO71	BP15	USBP3N	BT33	VccASW	AU32
THRMTRIP#	E56	USBP3P	BU32	VccASW	AV36
TP1	P22	USBP4N	BR32	VccASW	AU34
TP2	L31	USBP4P	BT31	VccASW	AG24
TP3	L33	USBP5N	BN29	VccASW	AG26
TP4	M38	USBP5P	BM30	VccASW	AG28
TP5	L36	USBP6N	BK33	VccASW	AJ24
TP6	Y18	USBP6P	BJ33	VccASW	AJ26
TP7	Y17	USBP7N	BF31	VccASW	AJ28
TP8	AB18	USBP7P	BD31	VccASW	AL24
TP9	AB17	USBP8N	BN27	VccASW	AL28
TP10	BM46	USBP8P	BR29	VccASW	AN22
TP11	BA27	USBP9N	BR26	VccASW	AN24
TP12	BC49	USBP9P	BT27	VccASW	AN26
TP13	AE49	USBP10N	BK25	VccASW	AN28
TP14	AE41	USBP10P	BJ25	VccASW	AR24
TP15	AE43	USBP11N	BJ31	VccASW	AR26
TP16	AE50	USBP11P	BK31	VccASW	AR28
TP17	BA36	USBP12N	BF27	VccASW	AR30
		USBP12P	BD27		



Desktop PCH Ball Map	Ball #	Desktop PCH Ball Map	Ball #	Desktop PCH Ball Map	Ball #
VccASW	AR36	VccIO	AE40	Vss	A26
VccASW	AR38	VccIO	BA38	Vss	A29
VccASW	AU30	VccIO	AG38	Vss	A42
VccASW	AU36	VccIO	AG40	Vss	A49
VccClkDMI	AJ20	VccIO	AA34	Vss	A9
VccCore	AC24	VccIO	AA36	Vss	AA20
VccCore	AC26	VccIO	F20	Vss	AA22
VccCore	AC28	VccIO	F30	Vss	AA24
VccCore	AC30	VccIO	V25	Vss	AA26
VccCore	AC32	VccIO	V27	Vss	AA28
VccCore	AE24	VccIO	V31	Vss	AA30
VccCore	AE28	VccIO	V33	Vss	AA38
VccCore	AE30	VccIO	Y24	Vss	AB11
VccCore	AE32	VccIO	Y26	Vss	AB15
VccCore	AE34	VccIO	Y30	Vss	AB40
VccCore	AE36	VccIO	Y32	Vss	AB41
VccCore	AG32	VccIO	Y34	Vss	AB43
VccCore	AG34	VccIO	V22	Vss	AB47
VccCore	AJ32	VccIO	Y20	Vss	AB52
VccCore	AJ34	VccIO	Y22	Vss	AB57
VccCore	AJ36	VccDFTERM	T55	Vss	AB6
VccCore	AL32	VccDFTERM	T57	Vss	AC22
VccCore	AL34	VccRTC	BU42	Vss	AC34
VccCore	AN32	VccSPI	AN52	Vss	AC36
VccCore	AN34	VccSSC	AC20	Vss	AC38
VccCore	AR32	VccSSC	AE20	Vss	AC4
VccCore	AR34	VccSus3_3	U31	Vss	AC54
VccDIFFCLKN	AE15	VccSus3_3	AV30	Vss	AE14
VccDIFFCLKN	AE17	VccSus3_3	AV32	Vss	AE18
VccDIFFCLKN	AG15	VccSus3_3	AY31	Vss	AE22
VccDMI	E41	VccSus3_3	AY33	Vss	AE26
VccDMI	B41	VccSus3_3	BJ36	Vss	AE38
VccDSW3_3	AV40	VccSus3_3	BK36	Vss	AE4
VccIO	AV24	VccSus3_3	BM36	Vss	AE47
VccIO	AV26	VccSus3_3	AT40	Vss	AE8
VccIO	AY25	VccSus3_3	AU38	Vss	AE9
VccIO	AY27	VccSus3_3	BT35	Vss	AF52
VccIO	AG41	VccSusHDA	AV28	Vss	AF6
VccIO	AL40	VccVRM	AJ1	Vss	AG11
VccIO	AN40	VccVRM	R56	Vss	AG14
VccIO	AN41	VccVRM	R54	Vss	AG20
VccIO	AJ38	VccVRM	R2	Vss	AG22
VccIO	Y36	Vss	AE56	Vss	AG30
VccIO	V36	Vss	BR36	Vss	AG36
VccIO	Y28	Vss	C12	Vss	AG43
		Vss	AY22	Vss	AG44

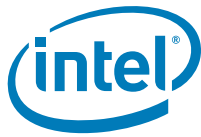

Desktop PCH Ball Map	Ball #	Desktop PCH Ball Map	Ball #	Desktop PCH Ball Map	Ball #
Vss	AG46	Vss	AT6	Vss	BF6
Vss	AG5	Vss	AT8	Vss	BG22
Vss	AG50	Vss	AU24	Vss	BG25
Vss	AG53	Vss	AU26	Vss	BG27
Vss	AH52	Vss	AU28	Vss	BG31
Vss	AH6	Vss	AU5	Vss	BG33
Vss	AJ22	Vss	AV12	Vss	BG36
Vss	AJ30	Vss	AV18	Vss	BG38
Vss	AJ57	Vss	AV22	Vss	BH52
Vss	AK52	Vss	AV34	Vss	BH6
Vss	AK6	Vss	AV38	Vss	BJ1
Vss	AL11	Vss	AV47	Vss	BJ15
Vss	AL18	Vss	AV6	Vss	BK20
Vss	AL20	Vss	AW57	Vss	BK41
Vss	AL22	Vss	AY38	Vss	BK52
Vss	AL26	Vss	AY6	Vss	BK6
Vss	AL30	Vss	B23	Vss	BM10
Vss	AL36	Vss	BA11	Vss	BM12
Vss	AL41	Vss	BA12	Vss	BM16
Vss	AL46	Vss	BA31	Vss	BM22
Vss	AL47	Vss	BA41	Vss	BM23
Vss	AM3	Vss	BA44	Vss	BM26
Vss	AM52	Vss	BA49	Vss	BM28
Vss	AM57	Vss	BB1	Vss	BM32
Vss	AN11	Vss	BB3	Vss	BM40
Vss	AN12	Vss	BB52	Vss	BM42
Vss	AN15	Vss	BB6	Vss	BM48
Vss	AN17	Vss	BC14	Vss	BM5
Vss	AN18	Vss	BC15	Vss	BN31
Vss	AN20	Vss	BC20	Vss	BN47
Vss	AN30	Vss	BC27	Vss	BN6
Vss	AN36	Vss	BC31	Vss	BP3
Vss	AN4	Vss	BC36	Vss	BP33
Vss	AN43	Vss	BC38	Vss	BP35
Vss	AN47	Vss	BC47	Vss	BR22
Vss	AN54	Vss	BC9	Vss	BR52
Vss	AN9	Vss	BD25	Vss	BU19
Vss	AR20	Vss	BD33	Vss	BU26
Vss	AR22	Vss	BF12	Vss	BU29
Vss	AR52	Vss	BF20	Vss	BU36
Vss	AR6	Vss	BF25	Vss	BU39
Vss	AT15	Vss	BF33	Vss	C19
Vss	AT18	Vss	BF41	Vss	C32
Vss	AT43	Vss	BF43	Vss	C39
Vss	AT47	Vss	BF46	Vss	C4
Vss	AT52	Vss	BF52	Vss	D15



Desktop PCH Ball Map	Ball #	Desktop PCH Ball Map	Ball #	Desktop PCH Ball Map	Ball #
Vss	D23	Vss	L43	Vss	Y11
Vss	D3	Vss	M20	Vss	Y15
Vss	D35	Vss	M22	Vss	Y38
Vss	D43	Vss	M25	Vss	Y40
Vss	D45	Vss	M27	Vss	Y43
Vss	E19	Vss	M31	Vss	Y46
Vss	E39	Vss	M33	Vss	Y47
Vss	E54	Vss	M36	Vss	Y49
Vss	E6	Vss	M46	Vss	Y52
Vss	E9	Vss	M52	Vss	Y6
Vss	F10	Vss	M57	Vss	AL43
Vss	F12	Vss	M6	Vss	AL44
Vss	F16	Vss	M8	Vss	R36
Vss	F22	Vss	M9	Vss	P36
Vss	F26	Vss	N4	Vss	R25
Vss	F32	Vss	N54	Vss	P25
Vss	F33	Vss	R11	VSS_NCTF	A4
Vss	F35	Vss	R15	VSS_NCTF	A6
Vss	F36	Vss	R17	VSS_NCTF	B2
Vss	F40	Vss	R22	VSS_NCTF	BM1
Vss	F42	Vss	R4	VSS_NCTF	BM57
Vss	F46	Vss	R41	VSS_NCTF	BP1
Vss	F48	Vss	R43	VSS_NCTF	BP57
Vss	F50	Vss	R46	VSS_NCTF	BT2
Vss	F8	Vss	R49	VSS_NCTF	BU4
Vss	G54	Vss	T52	VSS_NCTF	BU52
Vss	H15	Vss	T6	VSS_NCTF	BU54
Vss	H20	Vss	U11	VSS_NCTF	BU6
Vss	H22	Vss	U15	VSS_NCTF	D1
Vss	H25	Vss	U17	VSS_NCTF	F1
Vss	H27	Vss	U20	VssADAC	AU2
Vss	H33	Vss	U22	WAKE#	BC44
Vss	H6	Vss	U25	XCLK_RCOMP	AL2
Vss	J1	Vss	U27	XTAL25_IN	AJ3
Vss	J33	Vss	U33	XTAL25_OUT	AJ5
Vss	J46	Vss	U36		
Vss	J48	Vss	U38		
Vss	J5	Vss	U41		
Vss	J53	Vss	U47		
Vss	K52	Vss	U53		
Vss	K6	Vss	V20		
Vss	K9	Vss	V38		
Vss	L12	Vss	V6		
Vss	L17	Vss	W1		
Vss	L38	Vss	W55		
Vss	L41	Vss	W57		



6.2 Mobile PCH Ballout

This section contains the PCH ballout. Figure 6-5, Figure 6-6, Figure 6-7 and Figure 6-8 show the ballout from a top of the package quadrant view. Table 6-2 is the BGA ball list, sorted alphabetically by signal name.

Figure 6-5. Mobile PCH Ballout (Top View - Upper Left)

	49	48	47	46	45	44	43	42	41	40	39	38	37	36	35	34	33	32	31	30	29	28	27	26		
BJ				VSS_NCTH	VSS_NCTH	VSS_NCTH		DDPD_3N		PERp7		PERn6		PERp3		PERn1		TP28		CLKIN_GND_1_N		VSS		TP2		
BH			VSS_NCTE			VSS		DDPD_HPDI		VSS		PERp3		VSS		VSS	VSS	VSS		CLKIN_GND_1_P	VCC3_3		VSS			
BG		VSS_NCTF		TP24		VSS		DDPD_3P	VSS	PERn7		PERp6	PERn3	PERn3		PERn1	VSS	TP32		CLKIN_GND_1_P	VSS	VSS		TP1		
BF	VSS_NCTF		VCCADPLL			DDPD_1N		DDPD_3N		VSS		VSS		PERn4		PERp2		TP31		VSS		VSS		VSS		
BE	VSS_NCTF					DDPD_1P		DDPD_2P		VSS		PERn8		PERp4		PERn2		TP27		TP30		TP25		VSS		
BD	VSS_NCTF		VCCADPLLA	VSS																						
BC		VSS						VSS		VSS		PERp8		VSS		VSS		VSS		TP26		TP29		VSS		
BB	DDPC_3P		DDPC_3N	VSS	DDPC_0P		DDPC_0N			PETp7		VSS		PETp5		PETp4		PETn2		VSS		VSS		TP24		
BA		DDPC_2P	DDPC_2N																							
AY	DDPC_0P		DDPC_0N	VSS	DDPC_1P		DDPC_1N	VSS		PETn7		PETp8		PETn5		PETn4		PETp2			TP36		VSS	TP38		
AW		VSS								VSS		PETn8		VSS		VSS		VSS		TP40		VSS		VSS		
AV	DDPB_3P		DDPB_3N	DDPB_1P	DDPB_1N		VSS	DDPB_0N		DDPB_0P		VSS		PETp6		PETn3		PETn1		VSS		TP39		TP33		
AU		DDPB_2N	DDPB_2P											PETn6		PETp3		PETp1		VSS		TP35		TP37		
AT	DDPB_AUX_N		DDPB_AUX_P	VSS	DDPB_AUX_N		DDPB_AUX_P	VSS		DDPB_HPDI	VSS	DDPC_HPDI				VSS		VSS		VSS		VSS		VSS		
AR		VSS																								
AP	DDPC_AUX_P		DDPC_AUX_N	VSS	SDVO_TVCL_KINP		SDVO_TVCL_KINN	VSS		SDVO_INIP	SDVO_ININ	VSS	VCCIX_LVDS	VCCIX_LVDS				VSS		VSS		VSS		VCCIO		
AN		LVDSA_DAT_A#0	LVDSA_DAT_A#0															VCCIO	VCCIO		VSS		VSS	VCCIO	VCCIO	
AM	LVDSA_DAT_A#1		LVDSA_DAT_A#1	VSS	VSS		SDVO_STAL_LN		SDVO_STAL_LP	VSS		VCCIX_LVDS	VCCIX_LVDS	VSS												
AL		VSS																VSS	VSS		VSS		VCCIO	VSS	VSS	
AK	LVDSA_DAT_A#2		LVDSA_DAT_A#2	VSS	TP9		TP8	VSS		LVDSA_CLK_#	LVDSA_CLK_#	VSS	VSS	VCCALVDS												
AJ		LVDSA_DAT_A#3	LVDSA_DAT_A#3																	VCCCore		VCCCore		VCCCore	VCCCore	
AH	LVDSB_DAT_A#1		LVDSB_DAT_A#1	VSS	LVDSB_DAT_A#0		LVDSB_DAT_A#0	VSS		VSS	VSS	TP6	TP7	VSS												
AG		VSS																		VCCDIFFCLK_N	VCCSDC		VSS	VCCCore	VCCCore	VCCCore
AF	LVDSB_DAT_A#2		LVDSB_DAT_A#2	VSS	LVDSB_DAT_A#3		LVDSB_DAT_A#3	VSS		LVDSB_CLK_#	LVDSB_CLK_#	VSS	LVD_IBG	LVD_VBG						VCCDIFFCLK_N	VCCDIFFCLK_N		VSS	VSS	VSS	VSS

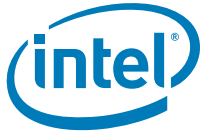

Figure 6-7. Mobile PCH Ballout (Top View - Upper Right)

	25	24	23	22	21	20	19	18	17	16	15	14	13	12	11	10	9	8	7	6	5	4	3	2	1		
		DMI_ZCOMP		VccAPLEX		DM3RXP		DM3RXP		TP4		FDI_RXN6		FDI_RXN6		FDI_RXN6		VPROC_ID		Yes_NCTF	Yes_NCTF	Yes_NCTF				BJ	
	TP3		VccAPLLD		DM3RBIAS		Yes		Yes		Yes		FDI_RXN3		Yes		FDI_RXP7		Yes				Yes_NCTF			BH	
	DMI_IRCOMP	Yes		Yes	Yes	DM3RXN		DM3RXN		TP5		FDI_RXP0	FDI_RXP3	FDI_RXP5		FDI_RXN6	FDI_RXN7	Yes		VccAFDIPL		Reserved		Yes_NCTF		BG	
		Yes		Yes	Yes			CLKIN_DMI		Yes		FDI_RXP2		Yes		Yes		Yes		Reserved		Reserved		Yes_NCTF		BF	
				Yes		DM3RXP		DM3RXN		CLKIN_DMI		Yes		FDI_RXN2		FDI_RXP4		Yes		Reserved				Yes_NCTF		BE	
																				Yes	Reserved	Yes		Yes_NCTF		BD	
						DM3RXN		Yes		DM3RXP		Yes		Yes		FDI_RXN4		FDI_FSYNC		Reserved				Yes		BC	
						Yes		Yes		DM3TXN		Yes		FDI_RXP1		Yes		FDI_LSYNC		Reserved		Reserved	Yes	Reserved	Reserved	BB	
																										BA	
						DM3TXP		Yes		DM3TXP		DM3TXP		TP23		FDI_RXN1		PROCPWR		TH3MT3P4		Yes	Reserved	Reserved	Yes	Reserved	AY
						DM3TXN		Yes		DM3TXN		Yes		FDI_LINT		Yes									Yes	AW	
						Yes		CLKOUT_D		Yes		DM3TXN		Yes		FDI_LSYNC		FDI_FSYNC		Reserved		Yes	Reserved	Reserved	Yes	Reserved	AV
						Yes		CLKOUT_D		Yes		DM3TXP		PEQI											Reserved	AU	
						VccIO		Yes		VccDM		Yes		VccVRM											Reserved	AT	
																									Yes	AR	
						VccIO	VccIO		VccIO	Yes		VccIO	VccVRM			PMSYNCH	Yes	Yes	SATA1TXN	SATA1TXP		Yes	SATA0TXN	SATA0TXP	Yes	Yes	AP
						VccSus3_3	DcpSus		VccIO		VccIO	VccIO	VccIO												Yes	Yes	AN
																									Yes	Yes	AM
						DcpSus	Yes		Yes		Yes	Yes													Yes	Yes	AL
																										Yes	AK
																										Yes	AJ
						Yes	VccCore		Yes			VccDFTER	VccDFTER												Yes	Vcc3_3	
																										Yes	AH
						VccCore	VccCore		VccCore		Yes	VccDFTER	VccDFTER													Yes	AG
						Yes	VccCore		VccCore		Yes	VccIO	Yes													Yes	AF
																										Yes	AF



Table 6-2. Mobile PCH Ballout By Signal Name

Mobile PCH Ball Name	Ball #	Mobile PCH Ball Name	Ball #	Mobile PCH Ball Name	Ball #
A20GATE	P4	CLKOUT_PCIE7N	V38	DDPC_1P	AY45
ACPRESENT / GPIO31	H20	CLKOUT_PCIE7P	V37	DDPC_2N	BA47
APWROK	L10	CLKOUT_PEG_A_N	AB37	DDPC_2P	BA48
BATLOW# / GPIO72	E10	CLKOUT_PEG_A_P	AB38	DDPC_3N	BB47
BMBUSY# / GPIO0	T7	CLKOUT_PEG_B_N	AB42	DDPC_3P	BB49
CL_CLK1	M7	CLKOUT_PEG_B_P	AB40	DDPC_AUXN	AP47
CL_DATA1	T11	CLKOUTFLEX0 / GPIO64	K43	DDPC_AUXP	AP49
CL_RST1#	P10	CLKOUTFLEX1 / GPIO65	F47	DDPC_CTRLCLK	P46
CLKIN_DMI_N	BF18	CLKOUTFLEX2 / GPIO66	H47	DDPC_CTRLDATA	P42
CLKIN_DMI_P	BE18	CLKOUTFLEX3 / GPIO67	K49	DDPC_HPD	AT38
CLKIN_DOT_96N	G24	CLKRUN# / GPIO32	N3	DDPD_0N	BB43
CLKIN_DOT_96P	E24	CRT_BLUE	N48	DDPD_0P	BB45
CLKIN_GND1_N	BJ30	CRT_DDC_CLK	T39	DDPD_1N	BF44
CLKIN_GND1_P	BG30	CRT_DDC_DATA	M40	DDPD_1P	BE44
CLKIN_PCILOOPBACK	H45	CRT_GREEN	P49	DDPD_2N	BF42
CLKIN_SATA_N	AK7	CRT_HSYNC	M47	DDPD_2P	BE42
CLKIN_SATA_P	AK5	CRT_IRTN	T42	DDPD_3N	BJ42
CLKOUT_DMI_N	AV22	CRT_RED	T49	DDPD_3P	BG42
CLKOUT_DMI_P	AU22	CRT_VSYNC	M49	DDPD_AUXN	AT45
CLKOUT_DP_N	AM12	DAC_IREF	T43	DDPD_AUXP	AT43
CLKOUT_DP_P	AM13	DcpRTC	N16	DDPD_CTRLCLK	M43
CLKOUT_ITPXD_N	AK14	DcpSST	V16	DDPD_CTRLDATA	M36
CLKOUT_ITPXD_P	AK13	DcpSus	AL24	DDPD_HPD	BH41
CLKOUT_PCI0	H49	DcpSus	T17	DMI_IRCOMP	BG25
CLKOUT_PCI1	H43	DcpSus	V19	DMI_ZCOMP	BJ24
CLKOUT_PCI2	J48	DcpSus	AN23	DMI0RXN	BC24
CLKOUT_PCI3	K42	DcpSusByp	V12	DMI0RXP	BE24
CLKOUT_PCI4	H40	DDPB_0N	AV42	DMI0TXN	AW24
CLKOUT_PCIE0N	Y40	DDPB_0P	AV40	DMI0TXP	AY24
CLKOUT_PCIE0P	Y39	DDPB_1N	AV45	DMI1RXN	BE20
CLKOUT_PCIE1N	AB49	DDPB_1P	AV46	DMI1RXP	BC20
CLKOUT_PCIE1P	AB47	DDPB_2N	AU48	DMI1TXN	AW20
CLKOUT_PCIE2N	AA48	DDPB_2P	AU47	DMI1TXP	AY20
CLKOUT_PCIE2P	AA47	DDPB_3N	AV47	DMI2RBIAS	BH21
CLKOUT_PCIE3N	Y37	DDPB_3P	AV49	DMI2RXN	BG18
CLKOUT_PCIE3P	Y36	DDPB_AUXN	AT49	DMI2RXP	BJ18
CLKOUT_PCIE4N	Y43	DDPB_AUXP	AT47	DMI2TXN	BB18
CLKOUT_PCIE4P	Y45	DDPB_HPD	AT40	DMI2TXP	AY18
CLKOUT_PCIE5N	V45	DDPC_0N	AY47	DMI3RXN	BG20
CLKOUT_PCIE5P	V46	DDPC_0P	AY49	DMI3RXP	BJ20
CLKOUT_PCIE6N	V40	DDPC_1N	AY43	DMI3TXN	AV18
CLKOUT_PCIE6P	V42			DMI3TXP	AU18
				DPWROK	E22



Mobile PCH Ball Name	Ball #
DRAMPWROK	B13
DSWVRMEN	A18
FDI_FSYNC0	AV12
FDI_FSYNC1	BC10
FDI_INT	AW16
FDI_LSYNC0	AV14
FDI_LSYNC1	BB10
FDI_RXN0	BJ14
FDI_RXN1	AY14
FDI_RXN2	BE14
FDI_RXN3	BH13
FDI_RXN4	BC12
FDI_RXN5	BJ12
FDI_RXN6	BG10
FDI_RXN7	BG9
FDI_RXP0	BG14
FDI_RXP1	BB14
FDI_RXP2	BF14
FDI_RXP3	BG13
FDI_RXP4	BE12
FDI_RXP5	BG12
FDI_RXP6	BJ10
FDI_RXP7	BH9
FWH0 / LAD0	C38
FWH1 / LAD1	A38
FWH2 / LAD2	B37
FWH3 / LAD3	C37
FWH4 / LFRAME#	D36
GNT1# / GPIO51	D47
GNT2# / GPIO53	E42
GNT3# / GPIO55	F46
GPIO1	A42
GPIO6	H36
GPIO7	E38
GPIO8	C10
GPIO15	G2
GPIO17	D40
GPIO24	E8
GPIO27	E16
GPIO28	P8
GPIO35	K4
GPIO57	D6
GPIO68	C40
GPIO69	B41

Mobile PCH Ball Name	Ball #
GPIO70	C41
GPIO71	A40
HDA_BCLK	N34
HDA_DOCK_EN# / GPIO33	C36
HDA_DOCK_RST# / GPIO13	N32
HDA_RST#	K34
HDA_SDIN0	E34
HDA_SDIN1	G34
HDA_SDIN2	C34
HDA_SDIN3	A34
HDA_SDO	A36
HDA_SYNC	L34
INIT3_3V#	T14
INTRUDER#	K22
INTVRMEN	C17
JTAG_TCK	J3
JTAG_TDI	K5
JTAG_TDO	H1
JTAG_TMS	H7
L_BKLTCTL	P45
L_BKLTEN	J47
L_CTRL_CLK	T45
L_CTRL_DATA	P39
L_DDC_CLK	T40
L_DDC_DATA	K47
L_VDD_EN	M45
LAN_PHY_PWR_CTRL / GPIO12	C4
LDRQ0#	E36
LDRQ1# / GPIO23	K36
LVD_IBG	AF37
LVD_VBG	AF36
LVD_VREFH	AE48
LVD_VREFL	AE47
LVDSA_CLK	AK40
LVDSA_CLK#	AK39
LVDSA_DATA#0	AN48
LVDSA_DATA#1	AM47
LVDSA_DATA#2	AK47
LVDSA_DATA#3	AJ48
LVDSA_DATA0	AN47
LVDSA_DATA1	AM49
LVDSA_DATA2	AK49

Mobile PCH Ball Name	Ball #
LVDSA_DATA3	AJ47
LVDSB_CLK	AF39
LVDSB_CLK#	AF40
LVDSB_DATA#0	AH45
LVDSB_DATA#1	AH47
LVDSB_DATA#2	AF49
LVDSB_DATA#3	AF45
LVDSB_DATA0	AH43
LVDSB_DATA1	AH49
LVDSB_DATA2	AF47
LVDSB_DATA3	AF43
TS_VSS1	AH8
TS_VSS2	AK11
TS_VSS3	AH10
TS_VSS4	AK10
NC_1	P37
Reserved	AV5
Reserved	AY7
Reserved	AV7
Reserved	AU3
Reserved	BG4
DF_TV5	AY1
Reserved	AU2
Reserved	AT4
Reserved	BB5
Reserved	BB3
Reserved	BB7
Reserved	BE8
Reserved	BD4
Reserved	BF6
Reserved	AT3
Reserved	AT1
Reserved	AY3
Reserved	AT5
Reserved	AV3
Reserved	AV1
Reserved	BB1
Reserved	BA3
Reserved	AT10
Reserved	BC8
Reserved	AT8
Reserved	AV10
Reserved	AY5
Reserved	BA2

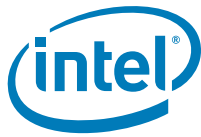

Mobile PCH Ball Name	Ball #
Reserved	AT12
Reserved	BF3
OC0# / GPIO59	A14
OC1# / GPIO40	K20
OC2# / GPIO41	B17
OC3# / GPIO42	C16
OC4# / GPIO43	L16
OC5# / GPIO9	A16
OC6# / GPIO10	D14
OC7# / GPIO14	C14
PCIECLKRQ0# / GPIO73	J2
PCIECLKRQ1# / GPIO18	M1
PCIECLKRQ2# / GPIO20	V10
PCIECLKRQ3# / GPIO25	A8
PCIECLKRQ4# / GPIO26	L12
PCIECLKRQ5# / GPIO44	L14
PCIECLKRQ6# / GPIO45	T13
PCIECLKRQ7# / GPIO46	K12
PECI	AU16
PEG_A_CLKRQ# / GPIO47	M10
PEG_B_CLKRQ# / GPIO56	E6
PERn1	BG34
PERn2	BE34
PERn3	BG36
PERn4	BF36
PERn5	BG37
PERn6	BJ38
PERn7	BG40
PERn8	BE38
PERp1	BJ34
PERp2	BF34
PERp3	BJ36
PERp4	BE36
PERp5	BH37
PERp6	BG38
PERp7	BJ40
PERp8	BC38
PETn1	AV32

Mobile PCH Ball Name	Ball #
PETn2	BB32
PETn3	AV34
PETn4	AY34
PETn5	AY36
PETn6	AU36
PETn7	AY40
PETn8	AW38
PETp1	AU32
PETp2	AY32
PETp3	AU34
PETp4	BB34
PETp5	BB36
PETp6	AV36
PETp7	BB40
PETp8	AY38
PIRQA#	K40
PIRQB#	K38
PIRQC#	H38
PIRQD#	G38
PIRQE# / GPIO2	G42
PIRQF# / GPIO3	G40
PIRQG# / GPIO4	C42
PIRQH# / GPIO5	D44
PLTRST#	C6
PME#	K10
PMSYNCH	AP14
PROCPWRGD	AY11
PWRBTN#	E20
PWROK	L22
RCIN#	P5
REFCLK14IN	K45
REQ1# / GPIO50	C46
REQ2# / GPIO52	C44
REQ3# / GPIO54	E40
RI#	A10
RSMRST#	C21
RTCST#	D20
RTCX1	A20
RTCX2	C20
SATA0GP / GPIO21	V14
SATA0RXN	AM3
SATA0RXP	AM1
SATA0TXN	AP7
SATA0TXP	AP5

Mobile PCH Ball Name	Ball #
SATA1GP / GPIO19	P1
SATA1RXN	AM10
SATA1RXP	AM8
SATA1TXN	AP11
SATA1TXP	AP10
SATA2GP / GPIO36	V8
SATA2RXN	AD7
SATA2RXP	AD5
SATA2TXN	AH5
SATA2TXP	AH4
SATA3COMPI	AB13
SATA3GP / GPIO37	M5
SATA3RBIAS	AH1
SATA3RCOMPO	AB12
SATA3RXN	AB8
SATA3RXP	AB10
SATA3TXN	AF3
SATA3TXP	AF1
SATA4GP / GPIO16	U2
SATA4RXN	Y7
SATA4RXP	Y5
SATA4TXN	AD3
SATA4TXP	AD1
SATA5GP / GPIO49/ THERM_ALERT#	V3
SATA5RXN	Y3
SATA5RXP	Y1
SATA5TXN	AB3
SATA5TXP	AB1
SATAICOMPI	Y10
SATAICOMPO	Y11
SATALED#	P3
SCLOCK / GPIO22	T5
SDATAOUT0 / GPIO39	M3
SDATAOUT1 / GPIO48	V13
SDVO_CTRLCLK	P38
SDVO_CTRLDATA	M39
SDVO_INTN	AP39
SDVO_INTP	AP40
SDVO_STALLN	AM42
SDVO_STALLP	AM40
SDVO_TVCLKINN	AP43
SDVO_TVCLKINP	AP45



Mobile PCH Ball Name	Ball #
SERIRQ	V5
SLOAD / GPIO38	N2
SLP_A#	G10
SLP_LAN# / GPIO29	K14
SLP_S3#	F4
SLP_S4#	H4
SLP_S5# / GPIO63	D10
SLP_SUS#	G16
SMBALERT# / GPIO11	E12
SMBCLK	H14
SMBDATA	C9
SMLOALERT# / GPIO60	A12
SML0CLK	C8
SML0DATA	G12
SML1ALERT# / PCHHOT# / GPIO74	C13
SML1CLK / GPIO58	E14
SML1DATA / GPIO75	M16
SPI_CLK	T3
SPI_CS0#	Y14
SPI_CS1#	T1
SPI_MISO	U3
SPI_MOSI	V4
SPKR	T10
SRTCST#	G22
STP_PCI# / GPIO34	K1
SUS_STAT# / GPIO61	G8
SUSACK#	C12
SUSCLK / GPIO62	N14
SUSWARN# / SUSPWRDNACK / GPIO30	K16
SYS_PWROK	P12
SYS_RESET#	K3
THRMTrip#	AY10
TP1	BG26
TP2	BJ26
TP3	BH25
TP4	BJ16
TP5	BG16
TP6	AH38
TP7	AH37
TP8	AK43

Mobile PCH Ball Name	Ball #
TP9	AK45
TP10	C18
TP11	N30
TP12	H3
TP13	AH12
TP14	AM4
TP15	AM5
TP16	Y13
TP17	K24
TP18	L24
TP19	AB46
TP20	AB45
TP21	B21
TP22	M20
TP23	AY16
TP24	BG46
TP25	BE28
TP26	BC30
TP27	BE32
TP28	BJ32
TP29	BC28
TP30	BE30
TP31	BF32
TP32	BG32
TP33	AV26
TP34	BB26
TP35	AU28
TP36	AY30
TP37	AU26
TP38	AY26
TP39	AV28
TP40	AW30
USBP0N	C24
USBP0P	A24
USBP1N	C25
USBP1P	B25
USBP2N	C26
USBP2P	A26
USBP3N	K28
USBP3P	H28
USBP4N	E28
USBP4P	D28
USBP5N	C28
USBP5P	A28

Mobile PCH Ball Name	Ball #
USBP6N	C29
USBP6P	B29
USBP7N	N28
USBP7P	M28
USBP8N	L30
USBP8P	K30
USBP9N	G30
USBP9P	E30
USBP10N	C30
USBP10P	A30
USBP11N	L32
USBP11P	K32
USBP12N	G32
USBP12P	E32
USBP13N	C32
USBP13P	A32
USBRBIAS	B33
USBRBIAS#	C33
V_PROC_IO	BJ8
V5REF	P34
V5REF_Sus	M26
Vcc3_3	AJ2
Vcc3_3	T34
Vcc3_3	AA16
Vcc3_3	W16
Vcc3_3	T38
Vcc3_3	BH29
Vcc3_3	V33
Vcc3_3	V34
VccAClk	AD49
VccADAC	U48
VccADPLLA	BD47
VccADPLLB	BF47
VccAFDIPLL	BG6
VccALVDS	AK36
VccAPLLDMI2	BH23
VccAPLLEXP	BJ22
VccAPLLSATA	AK1
VccASW	T19
VccASW	V21
VccASW	T21
VccASW	AA19
VccASW	AA21



Mobile PCH Ball Name	Ball #
VccASW	AA24
VccASW	AA26
VccASW	AA27
VccASW	AA29
VccASW	AA31
VccASW	AC26
VccASW	AC27
VccASW	AC29
VccASW	AC31
VccASW	AD29
VccASW	AD31
VccASW	W21
VccASW	W23
VccASW	W24
VccASW	W26
VccASW	W29
VccASW	W31
VccASW	W33
VccClkDMI	AB36
VccCore	AA23
VccCore	AC23
VccCore	AD21
VccCore	AD23
VccCore	AF21
VccCore	AF23
VccCore	AG21
VccCore	AG23
VccCore	AG24
VccCore	AG26
VccCore	AG27
VccCore	AG29
VccCore	AJ23
VccCore	AJ26
VccCore	AJ27
VccCore	AJ29
VccCore	AJ31
VccDIFFCLKN	AF33
VccDIFFCLKN	AF34
VccDIFFCLKN	AG34
VccDMI	AU20
VccDMI	AT20
VccDSW3_3	T16
VccIO	N26
VccIO	P26

Mobile PCH Ball Name	Ball #
VccIO	P28
VccIO	T27
VccIO	T29
VccIO	AF13
VccIO	AC16
VccIO	AC17
VccIO	AD17
VccIO	AF14
VccIO	AP17
VccIO	AN19
VccIO	AL29
VccIO	AF17
VccIO	T26
VccIO	AH13
VccIO	AH14
VccIO	AN16
VccIO	AN17
VccIO	AN21
VccIO	AN26
VccIO	AN27
VccIO	AP21
VccIO	AP23
VccIO	AP24
VccIO	AP26
VccIO	AT24
VccIO	AN33
VccIO	AN34
VccDFTERM	AG16
VccDFTERM	AG17
VccDFTERM	AJ16
VccDFTERM	AJ17
VccRTC	A22
VccSPI	V1
VccSSC	AG33
VccSus3_3	AN24
VccSus3_3	T23
VccSus3_3	T24
VccSus3_3	V23
VccSus3_3	V24
VccSus3_3	N20
VccSus3_3	N22
VccSus3_3	P20
VccSus3_3	P22

Mobile PCH Ball Name	Ball #
VccSus3_3	P24
VccSusHDA	P32
VccTX_LVDS	AM37
VccTX_LVDS	AM38
VccTX_LVDS	AP36
VccTX_LVDS	AP37
VccVRM	Y49
VccVRM	AF11
VccVRM	AP16
VccVRM	AT16
Vss	AJ3
Vss	N24
Vss	BG29
Vss	H5
Vss	AA17
Vss	AA2
Vss	AA3
Vss	AA33
Vss	AA34
Vss	AB11
Vss	AB14
Vss	AB39
Vss	AB4
Vss	AB43
Vss	AB5
Vss	AB7
Vss	AC19
Vss	AC2
Vss	AC21
Vss	AC24
Vss	AC33
Vss	AC34
Vss	AC48
Vss	AD10
Vss	AD11
Vss	AD12
Vss	AD13
Vss	AD14
Vss	AD16
Vss	AD19
Vss	AD24
Vss	AD26
Vss	AD27
Vss	AD33



Mobile PCH Ball Name	Ball #
Vss	AD34
Vss	AD36
Vss	AD37
Vss	AD38
Vss	AD39
Vss	AD4
Vss	AD40
Vss	AD42
Vss	AD43
Vss	AD45
Vss	AD46
Vss	AD47
Vss	AD8
Vss	AE2
Vss	AE3
Vss	AF10
Vss	AF12
Vss	AF16
Vss	AF19
Vss	AF24
Vss	AF26
Vss	AF27
Vss	AF29
Vss	AF31
Vss	AF38
Vss	AF4
Vss	AF42
Vss	AF46
Vss	AF5
Vss	AF7
Vss	AF8
Vss	AG19
Vss	AG2
Vss	AG31
Vss	AG48
Vss	AH11
Vss	AH3
Vss	AH36
Vss	AH39
Vss	AH40
Vss	AH42
Vss	AH46
Vss	AH7
Vss	AJ19

Mobile PCH Ball Name	Ball #
Vss	AJ21
Vss	AJ24
Vss	AJ33
Vss	AJ34
Vss	AK12
Vss	AK3
Vss	AK38
Vss	AK4
Vss	AK42
Vss	AK46
Vss	AK8
Vss	AL16
Vss	AL17
Vss	AL19
Vss	AL2
Vss	AL21
Vss	AL23
Vss	AL26
Vss	AL27
Vss	AL31
Vss	AL33
Vss	AL34
Vss	AL48
Vss	AM11
Vss	AM14
Vss	AM36
Vss	AM39
Vss	AM43
Vss	AM45
Vss	AM46
Vss	AM7
Vss	AN2
Vss	AN29
Vss	AN3
Vss	AN31
Vss	AP12
Vss	AP13
Vss	AP19
Vss	AP28
Vss	AP30
Vss	AP32
Vss	AP38
Vss	AP4
Vss	AP42

Mobile PCH Ball Name	Ball #
Vss	AP46
Vss	AP8
Vss	AR2
Vss	AR48
Vss	AT11
Vss	AT13
Vss	AT18
Vss	AT22
Vss	AT26
Vss	AT28
Vss	AT30
Vss	AT32
Vss	AT34
Vss	AT39
Vss	AT42
Vss	AT46
Vss	AT7
Vss	AU24
Vss	AU30
Vss	AV11
Vss	AV16
Vss	AV20
Vss	AV24
Vss	AV30
Vss	AV38
Vss	AV4
Vss	AV43
Vss	AV8
Vss	AW14
Vss	AW18
Vss	AW2
Vss	AW22
Vss	AW26
Vss	AW28
Vss	AW32
Vss	AW34
Vss	AW36
Vss	AW40
Vss	AW48
Vss	AY12
Vss	AY22
Vss	AY28
Vss	AY4
Vss	AY42



Mobile PCH Ball Name	Ball #
Vss	AY46
Vss	AY8
Vss	B11
Vss	B15
Vss	B19
Vss	B23
Vss	B27
Vss	B31
Vss	B35
Vss	B39
Vss	B43
Vss	B7
Vss	BB12
Vss	BB16
Vss	BB20
Vss	BB22
Vss	BB24
Vss	BB28
Vss	BB30
Vss	BB38
Vss	BB4
Vss	BB46
Vss	BC14
Vss	BC18
Vss	BC2
Vss	BC22
Vss	BC26
Vss	BC32
Vss	BC34
Vss	BC36
Vss	BC40
Vss	BC42
Vss	BC48
Vss	BD3
Vss	BD46
Vss	BD5
Vss	BE10
Vss	BE22
Vss	BE26
Vss	BE40
Vss	BF10
Vss	BF12
Vss	BF16
Vss	BF20

Mobile PCH Ball Name	Ball #
Vss	BF22
Vss	BF24
Vss	BF26
Vss	BF28
Vss	BF30
Vss	BF38
Vss	BF40
Vss	BF8
Vss	BG17
Vss	BG21
Vss	BG22
Vss	BG24
Vss	BG33
Vss	BG41
Vss	BG44
Vss	BG8
Vss	BH11
Vss	BH15
Vss	BH17
Vss	BH19
Vss	BH27
Vss	BH31
Vss	BH33
Vss	BH35
Vss	BH39
Vss	BH43
Vss	BH7
Vss	C22
Vss	D12
Vss	D16
Vss	D18
Vss	D22
Vss	D24
Vss	D26
Vss	D3
Vss	D30
Vss	D32
Vss	D34
Vss	D38
Vss	D42
Vss	D8
Vss	E18
Vss	E26
Vss	F3

Mobile PCH Ball Name	Ball #
Vss	F45
Vss	G14
Vss	G18
Vss	G20
Vss	G26
Vss	G28
Vss	G36
Vss	G48
Vss	H10
Vss	H12
Vss	H16
Vss	H18
Vss	H22
Vss	H24
Vss	H26
Vss	H30
Vss	H32
Vss	H34
Vss	H46
Vss	K18
Vss	K26
Vss	K39
Vss	K46
Vss	K7
Vss	L18
Vss	L2
Vss	L20
Vss	L26
Vss	L28
Vss	L36
Vss	L48
Vss	M12
Vss	M14
Vss	M18
Vss	M22
Vss	M24
Vss	M30
Vss	M32
Vss	M34
Vss	M38
Vss	M4
Vss	M42
Vss	M46
Vss	M8



Mobile PCH Ball Name	Ball #	Mobile PCH Ball Name	Ball #
Vss	N18	Vss	AP1
Vss	N47	Vss	BE16
Vss	P11	Vss	BC16
Vss	P16	Vss	BG28
Vss	P18	Vss	BJ28
Vss	P30	Vss_NCTF	A4
Vss	P40	Vss_NCTF	A44
Vss	P43	Vss_NCTF	A45
Vss	P47	Vss_NCTF	A46
Vss	P7	Vss_NCTF	A5
Vss	R2	Vss_NCTF	A6
Vss	R48	Vss_NCTF	B3
Vss	T12	Vss_NCTF	B47
Vss	T31	Vss_NCTF	BD1
Vss	T33	Vss_NCTF	BD49
Vss	T36	Vss_NCTF	BE1
Vss	T37	Vss_NCTF	BE49
Vss	T4	Vss_NCTF	BF1
Vss	T46	Vss_NCTF	BF49
Vss	T47	Vss_NCTF	BG2
Vss	T8	Vss_NCTF	BG48
Vss	V11	Vss_NCTF	BH3
Vss	V26	Vss_NCTF	BH47
Vss	V27	Vss_NCTF	BJ4
Vss	V29	Vss_NCTF	BJ44
Vss	V31	Vss_NCTF	BJ45
Vss	V36	Vss_NCTF	BJ46
Vss	V39	Vss_NCTF	BJ5
Vss	V43	Vss_NCTF	BJ6
Vss	V7	Vss_NCTF	C2
Vss	W17	Vss_NCTF	C48
Vss	W19	Vss_NCTF	D1
Vss	W2	Vss_NCTF	D49
Vss	W27	Vss_NCTF	E1
Vss	W34	Vss_NCTF	E49
Vss	W48	Vss_NCTF	F1
Vss	Y12	Vss_NCTF	F49
Vss	Y38	VssADAC	U47
Vss	Y4	VssALVDS	AK37
Vss	Y42	WAKE#	B9
Vss	Y46	XCLK_RCOMP	Y47
Vss	Y8	XTAL25_IN	V47
Vss	V17	XTAL25_OUT	V49
Vss	AP3		

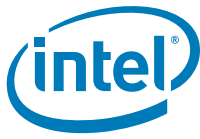

6.3 Mobile SFF PCH Ballout

Figure 6-9, Figure 6-10, Figure 6-11 and Figure 6-12 show the ballout from a top of the package quadrant view.

Figure 6-9. Mobile SFF PCH Package (Top View – Upper Left)

	51	50	49	48	47	46	45	44	43	42	41	40	39	38	37	36	35	34	33	32	31	30	29	28	27	26
BL	Vss_NCT_F	Vss_NCT_F	Vss_NCT_F	DDPD_2P	DDPD_3N			PERp8	PERp7	PERp5	PERp4	PERp2	PERp1		TP31	TP32	TP30									
BK					Vss	DDPD_HPDP			Vss	PERp6		Vss	PERp3	Vss	Vss	Vss	Vss	Vss	Vss	Vss	Vss	Vcc3_3	Vss			
BJ	Vss_NCT_F	Vss_NCT_F	TP21	DDPD_2N	DDPD_3P			PERn8	PERn7	PERn5	PERn4	PERn2	PERn1		TP27	TP28	TP26									
BH	Vss_NCT_F	TP41	Vss	Vss	Vss	Vss	Vss	PERn6	Vss	PERn3	Vss	Vss	Vss	Vss	Vss	Vss	Vss	Vss	Vss	Vss	Vss	Vss	Vss	Vss	Vss	
BG	DDPD_0N	DDPD_0P																								
BF	Vss	Vss		DDPC_2N	DDPC_2P		DDPD_1N	VccAD_PLLA		PETp6	PETp4	PETn3			TP36	TP35	TP33									
BE	DDPC_3P	DDPC_3N	DDPC_HPDP	Vss	Vss	Vss	Vss	Vss	Vss	Vss	Vss	Vss	Vss	Vss	Vss	Vss	Vss	Vss	Vss	Vss	Vss	Vss	Vss	Vss	Vss	
BD	DDPC_1P	DDPC_1N			DDPD_1P	VccAD_PLLB		PETn6	PETn4	PETp3					TP40	TP39	TP37									
BC	DDPC_0P	DDPC_0N		Vss	Vss	Vss	Vss	Vss	Vss	Vss	Vss	Vss	Vss	Vss	Vss	Vss	Vss	Vss	Vss	Vss	Vss	Vss	Vss	Vss	Vss	
BB	Vss	Vss	DDPB_2P	DDPB_2N	TP42	PETp8		PETp7	PETp5	PETn2				PETn1	TP34	CLKIN_GND1_N										
BA	DDPB_3P	DDPB_3N	Vss	Vss	Vss	Vss	Vss	Vss	Vss	Vss	Vss	Vss	Vss	Vss	Vss	Vss	Vss	Vss	Vss	Vss	Vss	Vss	Vss	Vss	Vss	
AY	DDPB_0P	DDPB_0N		DDPB_1P	DDPB_1N	DDPD_HPDP	PETn8		PETn7	PETn5	PETp2			PETp1	TP38	CLKIN_GND1_P										
AW	DDPB_AUXN	DDPB_AUXP		Vss	Vss	Vss	Vss	Vss	Vss	Vss	Vss	Vss	Vss	VccI_O	VccA_PLLD_M12	Vss	Vss									
AV	Vss	Vss																								
AU	DDPC_AUXN	DDPC_AUXP	DDPD_AUXN	DDPD_AUXP	SDVO_TVCLK_INP	SDVO_TVCLK_INN	Vss		Vss	Vss	Vss	Vss	Vss	Vss	Vss	VccI_O	DcpS_u s	DcpS_u s	VccI_O	VccI_O	VccI_O	VccI_O	VccI_O	VccI_O	VccI_O	
AT	SDVO_INTN	SDVO_INTP		Vss	Vss	Vss	Vss	Vss	Vss	Vss	Vss	Vss	Vss	Vss	Vss	Vss	Vss	Vss	Vss	Vss	Vss	Vss	Vss	Vss	Vss	
AR	SDVO_STALL_N	SDVO_STALL_P	LVDSA_DATA_0	LVDSA_DATA_0	TP9	TP8	Vss	Vss	DcpS_u s	Vss	Vss	Vss	Vss	Vss	Vss	Vss	Vss	Vss	Vss	Vss	Vss	Vss	Vss	Vss	Vss	
AP	Vss	Vss	Vss	Vss	Vss	Vss	Vss	Vss	VccClk_DMI	Vss	Vss	Vss	Vss	Vss	Vss	Vss	Vss	Vss	Vss	Vss	Vss	Vss	Vss	Vss	Vss	
AN	LVDSA_DATA_1	LVDSA_DATA_1	LVDSA_DATA_2	LVDSA_DATA_2	TP6	TP7																				
AM	LVDSB_DATA_0	LVDSB_DATA_0	Vss	Vss	Vss	Vss	Vss	Vss	Vss	Vss	Vss	Vss	Vss	Vss	VccC_ore	VccC_ore	Vss	Vss	Vss	Vss	Vss	Vss	Vss	Vss	VccS_us3_3	
AL	LVDSB_DATA_1	LVDSB_DATA_1		Vss	Vss	Vss	Vss	Vss	Vss	Vss	Vss	Vss	Vss	Vss	Vss	Vss	Vss	Vss	Vss	Vss	Vss	Vss	Vss	Vss	Vss	
AK	Vss	Vss	LVDSA_CLK	LVDSA_CLK#	LVDSA_DATA_3	LVDSA_DATA_3									Vss	Vss	VccC_ore	VccC_ore	VccC_ore	VccC_ore	VccC_ore	VccC_ore	VccC_ore	VccC_ore	Vss	
AJ	LVDSB_DATA_2	LVDSB_DATA_2	Vss	Vss	Vss	Vss	Vss	Vss	Vss	Vss	Vss	Vss	Vss	Vss	VccTX_LVDS	Vss	Vss	VccC_ore	VccC_ore	VccC_ore	VccC_ore	VccC_ore	VccC_ore	VccC_ore	VccC_ore	
AH	LVDSB_DATA_3	LVDSB_DATA_3	LVDSB_CLK#	LVDSB_CLK	LVD_I_BG	LVD_V_BG									VccTX_LVDS	Vss	VccAL_VDS	Vss	Vss	Vss	Vss	Vss	Vss	Vss	VccC_ore	
AG	LVD_V_REFH	LVD_V_REFL	Vss	Vss	Vss	Vss	Vss	Vss	VccTX_LVDS	VccTX_LVDS	Vss	VccAL_VDS	Vss	Vss	Vss	Vss	Vss	Vss	Vss	Vss	Vss	Vss	Vss	Vss	VccC_ore	
AF	Vss	Vss	CLKO_UT_PE_G_A_P	CLKO_UT_PE_G_A_N	CLKO_UT_PE_G_B_P	CLKO_UT_PE_G_B_N			VccTX_LVDS	Vss	VccAL_VDS	Vss	Vss	Vss	Vss	Vss	Vss	Vss	Vss	Vss	Vss	Vss	Vss	Vss	Vss	



Figure 6-10. Mobile SFF PCH Package (Top View – Lower Left)

Ball	CLK0 UT_PC IE1P	CLK0 UT_PC IE1N			Vss	Vss	Vss	VccD IFFC LKN	VccD IFFC LKN	Vss	VssALV DS	VccAS W	VccAS W	VccAS W												
AD	CLK0 UT_PC IE0P	CLK0 UT_PC IE0N	TP20	TP19	CLK0 UT_PC IE2P	CLK0 UT_PC IE2N																				
AC	VccAD lk	CLK0 UT_PC IE0P	Vss	Vss	Vss	Vss	VccVR M	VccD IFFC LKN	VccSS C	VssALV DS	VccAS W	VccAS W	VccAS W	VccAS W												
AB		Vss	Vss	CLK0 UT_PC IE5P	CLK0 UT_PC IE5N	CLK0 UT_PC IE5P	CLK0 UT_PC IE5N		Vss	Vss	Vss	VccAS W	VccAS W	VccAS W												
AA	CLK0 UT_PC IE3P	CLK0 UT_PC IE3N		Vss	Vss	Vss	Vss																			
Y	CLK0 UT_PC IE4P	CLK0 UT_PC IE4N						Vss	Vss	Vss	VccAS W	VccAS W	VccAS W													
W	XTAL2 5_OUT	XTAL2 5_IN	CLK0 UT_PC IE7P	CLK0 UT_PC IE7N	SDVO_CTRL LK		TP23																			
V	VSSA_DAC		Vss	Vss	Vss	Vss	Vcc3_3	Vcc3_3	Vss	Vss	VccSu s3DA	Vss	Vss													
U	VccAD AC	Vss		CRT_RE D	DDPC_CTRL DATA	DDPC_CTRL DATA	NC_1	Vcc3_3	VccSu s3_3	VccSu s3_3	Vss	VCCP USB	VCCP USB													
T		DDPC_CTRL CLK	CRT_I RTN		Vss	Vss	Vss	Vcc3_3																		
R	DAC_I REF	CRT_D DC_CLK		CRT_G REEN	SDVO_CTRL DATA	L_CTRL_CLK	Vcc3_3	Vss	VccSu s3_3	VccSu s3_3	Vss	VccSu s3_3	VccSu s3_3													
P		Vss	Vss																							
N	CRT_V SYNC	CRT_D DC_DATA		Vss	Vss	Vss	Vss	VREF		Vss	Vss	Vss	Vss	VccSu s3_3												
M		CRT_H SYNC	DDPC_CTRL CLK	CRT_B LUE	L_BKL TEN	L_VDD EN	L_CTRL_DATA	VREF_Su3	HDA_DOCK_RST#	USBP1 3N		TP11	USBP 8N	USBP 4N												
L	L_DDC_CLK	L_BKL TCTL		Vss	Vss	Vss	Vss		Vss	Vss		Vss	Vss	Vss												
K		Vss	Vss	L_DDC_DATA	REQ2# / GPIO5	TACH4 / GPIO6	FWH4 / LFRA ME#	HDA_SDO	HDA_DOCK_EN#	USBP1 3P		TP24	USBP 8P	USBP 4P												
J	CLK0 UT_FLE X0	REFCLK K14N		Vss	CLK0 UT_PC I3		Vss	Vss	Vss	Vss		Vss	Vss	Vss												
H	CLK0 UT_FLE X0	CLK0 UT_PC I2				GNT2# / GPIO5	LDRQ0 #	HDA_SYNC	HDA_BCLK	USBP1 1N		USBP1 2N	USBP 3N	USBP 6N												
G	CLK0 UT_PC I0	CLK0 UT_FLE X2		REQ1# / GPIO5	CLK0 UT_PC I4	Vss	Vss	Vss	Vss	Vss		Vss	Vss	Vss												
F		Vss	Vss	REQ3# / GPIO5	PIROG # / GPIO4		ENT1# / GPIO5	PIRQ1 # / GPIO5	LDRQ1 # / GPIO2	HDA_RST#	USBP1 1P		USBP1 2P	USBP 3P												
E	GLKN PCL COPB	CLK0 UT_PC I1																								
D	Vss_NCT F	PIROA # / X1	CLK0 UT_FLE X1	Vss	ENT3# / GPIO5	Vss	TACH8 / GPIO7	Vss	HDA_SDIN0	Vss	USBP 7N	Vss	USBP 5N	Vss												
C	Vss_NCT F	Vss_NCT F	PIROB #	PIROC #	PIROD #	TACH2 / GPIO6	PIROF # / GPIO3	FWH2 / LAD2	FWH3 / LAD3	HDA_SDIN2	USBR_BIAS#	USBP 0N	USBP 9N	USBP 2N												
B				Vss	TACH0 / GPIO1	Vss	TACH1 / GPIO1	Vss	HDA_SDIN1	Vss	USBP 7P	Vss	USBP 5P	Vss												
A	Vss_NCT F	Vss_NCT F	Vss_NCT F	PIROE # / GPIO2	TACH3 / GPIO7	TACH5 / GPIO6	TACH7 / GPIO7	FWH1 / LAD1	FWH0 / LAD0	HDA_SDIN3	USBR_BIAS	USBP 0P	USBP 9P	USBP 2P												
	51	50	49	48	47	46	45	44	43	42	41	40	39	38	37	36	35	34	33	32	31	30	29	28	27	26

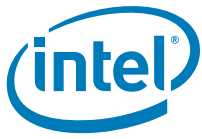

Figure 6-11. Mobile SFF PCH Package (Top View – Upper Right)

	25	24	23	22	21	20	19	18	17	16	15	14	13	12	11	10	9	8	7	6	5	4	3	2	1		
TP29			DMI1R_XN		DMI0R_XN		DMI2R_XP		DMI3R_XN		FDL_R_XP1		FDL_R_XN0		FDL_R_XP3		FDL_R_XP6		TP22		RSVD	Vss_NCT_F	Vss_NCT_F		Vss_NCT_F	BL	
		TP2		Vss		DMI2R_BIAS		Vss		TP4		Vss		FDL_L_SYNC0		Vss		FDL_F_SYNC1		RSVD						BK	
TP25		DMI1R_XP		DMI0R_XP		DMI2R_XN		DMI3R_XP		FDL_R_XN1		FDL_R_XP0		FDL_R_XN3		FDL_R_XN6		RSVD		RSVD	RSVD	Vss_NCT_F		Vss_NCT_F		Vss_NCT_F	BJ
		TP1		Vss		TP3		Vss		TP5		Vss		FDL_F_SYNC0		Vss		FDL_L_SYNC1		Vss		RSVD	RSVD		Vss_NCT_F	BH	
																							RSVD	RSVD		BG	
		Vss		DMI0T_XP		DMI_Z_COMP		CLKIN_DMIL_P		Vss			FDL_R_XP2		FDL_R_XN7				RSVD	RSVD		Vss		Vss		BF	
Vss		Vss		Vss				Vss		Vss		Vss		Vss		Vss		Vss		Vss	RSVD		RSVD		RSVD	BE	
		Vss		DMI0T_XN		DMI_I_RCOMP_P		CLKIN_DMIL_N		Vss			FDL_R_XN2		FDL_R_XP7							RSVD		RSVD		BD	
Vss		Vss		Vss				Vss		Vss		Vss		Vss		THRM_TRIP#		BF_TV_S					RSVD		RSVD	BC	
		CLKO_UT_D_ML_N		DMI1T_XN		DMI2T_XN		DMI3T_XN		FDL_R_XP4			FDL_R_XP5		FDL_IN_T		PMSY_NCH				RSVD		Vss		Vss	BB	
Vss		Vss		Vss				Vss		Vss		Vss		Vss		Vss		Vss		Vss			RSVD		RSVD	BA	
		CLKO_UT_D_ML_P		DMI1T_XP		DMI2T_XP		DMI3T_XP		FDL_R_XN4			FDL_R_XN5		Vss		RSVD		RSVD		RSVD		RSVD		RSVD	AY	
Vss		Vss		VccVR_M		VccVR_M		VccDM_I				Vss		Vss		Vss		Vss		Vss			RSVD		RSVD	AW	
																							Vss		Vss	AV	
VccIO		VccIO		VCCA_DML_V_RM		VCCAP_DL_VRM		Vss		VccDM_I			PECl		PROC_PWGRD		RSVD		RSVD				SATA0_TXN		SATA0_TXP	AU	
												VccO		Vss		Vss		Vss		Vss			TP14		TP15	AT	
VccIO		VccIO		Vss		Vss		Vss		VccO			CLKO_UT_IT_PXDP		CLKO_UT_IT_PXDP		Vss		Vss		Vss			SATA1_TXN		SATA1_TXP	AR
Vss		Vss		Vss		VccAP_LLEX_P		Vss		VccAF_DIPLL		VccAF_DIPLL		Vss		Vss		Vss		Vss			Vss		Vss	AP	
													CLKO_UT_DP_P		CLKO_UT_DP_N		SATA1_RXP		SATA1_RXN		SATA1_RXN		SATA0_RXN		SATA0_RXP	AN	
Vss		VccDM_I		VccIO		Vss		V_PRQ_C_IO		Vss													TP13		VCCA_PLL_SATA3	AM	
												VccDF_TERM		Vss		Vss		Vss		Vss				SATA2_TXN		SATA2_TXP	AL
Vss		Vss		VccIO		Vss		Vss		VccDF_TERM			TS_VS_S3		TS_VS_S1		CLKIN_SATA_N		CLKIN_SATA_P		Vss		Vss		Vss		AK
VccCore		VccCore		VccCore		Vss		VccO		VccDF_TERM		VccDF_TERM		Vss		Vss		Vss		Vss				SATA5_TXN		SATA5_TXP	AJ
													TS_VS_S2		TS_VS_S4		SATA4_TXN		SATA4_TXP		SATA4_TXP		SATA3_RBIAS		Vss	AH	
VccCore		VccCore		VccCore		Vss		Vss		VccO		VccO		Vss		Vss		Vss		Vss				SATA3_TXN		SATA3_TXP	AG
Vss		VccCore		VccCore		Vss		VccVR_RM		VccIO			SATA3_COMP1		SATA3_RCOMP_PO		Vss		Vcc3_3		Vss		Vss		Vss	AF	

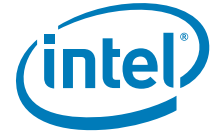

Figure 6-12. Mobile SFF PCH Package (Top View – Lower Right)

Vss	VccCore	VccCore	VccVRM	Vss	Vss	Vss	Vss	Vss	Vss	SATA4RXN	SATA4RXP	AE												
						SPLCLK	TP16	SATA3RXN	SATA3RXP	SATA2RXN	SATA2RXP	AD												
Vss	VccCore	VccCore	Vcc3_3	Vss	VccIO	Vss	Vss	Vss	Vss	SATA5RXN	SATA5RXP	AC												
Vss	VccCore	VccCore	Vcc3_3	Vss	VccIO	SATAI COMP	SATAI COMP	SPLCS0#	SPLCS#	Vss	Vss	AB												
VccASW	VccASW	VccASW	VccSP	Vss	Vss	Vss	Vss	Vss	Vss	SATA4GP/GPIO1	SATA5GP/GPIO4	AA												
VccASW	VccASW	VccASW	VccASW	Vss	Vss	SERIR	SERIR	SERIR	SERIR	SERIR	SERIR	Y												
VccASW	VccASW	VccASW	VccASW	Vss	Vss	GPIOS5	SATAL ED#	SPLM OS	SATA2GP/GPIO3	SCLOCK/GPIO2	BMBUSY#/GPIO3	W												
VccASW	VccASW	VccASW	VccASW	Vss	Vss	DcpS	Vss	Vss	Vss	Vss	Vss	V												
VccIO	VccIO	VccASW	VccASW	DcpSS	DcpRT	JTAGTDI	SDATAOUT	PCIECLKRQ1	PCIN#	A20GATE	SDATAOUT	U												
Vss	Vss	Vss	Vss	Vss	Vss	Vss	Vss	Vss	Vss	PCIECLKRQ2	CLKRUN#	T												
VccIO	VccIO	Vss	VccASW	Vss	DcpRT	VccDS	DcpS	PEG_ACLKRQ	INIT3	STP_C	SATA1GP/GPIO1	R												
										Vss	Vss	P												
Vss	Vss	Vss	VccIO	VccRT	Vss	Vss	Vss	Vss	Vss	SLOA	SPKR	N												
CLKIN_DOT_96N	PWRON		PCIECLKRQ4	JTAGTCK	JTAGTMS	JTAGTDO	SYS_P	CLRS	SATA3GP/GPIO3	PCIECLKRQ0	SATA0GP/GPIO2	M												
Vss	Vss	Vss	Vss	Vss	Vss	Vss	Vss	Vss	Vss	CLCLK1	SYS_R	L												
CLKIN_DOT_96P	INTRU	PWRB	GPIOS7	GPIOS4	GPIOS2	SML0	SLP_S	PCIECLKRQ5	GPIOS5	Vss	Vss	K												
Vss	Vss	Vss	Vss	Vss	Vss	Vss	Vss	Vss	Vss	PCIECLKRQ6	CLDATA1	J												
USBP	SML0	ACPR	GPIOS8	OC7	SMBALERT	BATLOW	BATLOW	PCIECLKRQ7	PME	PCIECLKRQ7	PME	H												
Vss	Vss	Vss	Vss	Vss	Vss	Vss	Vss	Vss	Vss	SUS	APWR	G												
USBP	DSW	RTR	SMBC	SUSACK	R	SMBDATA	SMBDATA	PLTRS	SLP_S	Vss	Vss	F												
												E												
TP18	Vss	TP10	Vss	OC3	Vss	SML0	Vss	WAKE	Vss	SLP_S	SUS	D												
USBP	OC1	INTR	RTC2	OC5	GPIOS7	SUS	SML0	SML1	SLP_A	LAN_P	PEG_B	C												
	TP17	Vss	RSMR	Vss	OC5	Vss	DRAM	Vss	PCIECLKRQ3	Vss	Vss	B												
USBP	SRTC	DPWR	RTC1	OC1	SLP_S	OC2	OC4	SML0	SLP_L	Vss	Vss	A												
25	24	23	22	21	20	19	18	17	16	15	14	13	12	11	10	9	8	7	6	5	4	3	2	1

§ §





7 *Package Information*

7.1 Desktop PCH package

- FCBGA package
- Package size: 27 mm x 27 mm
- Ball Count: 942
- Ball pitch: 0.7 mm

The Desktop PCH package information is shown in [Figure 7-1](#).

Note: All dimensions, unless otherwise specified, are in millimeters.

Figure 7-1. Desktop PCH Package Drawing

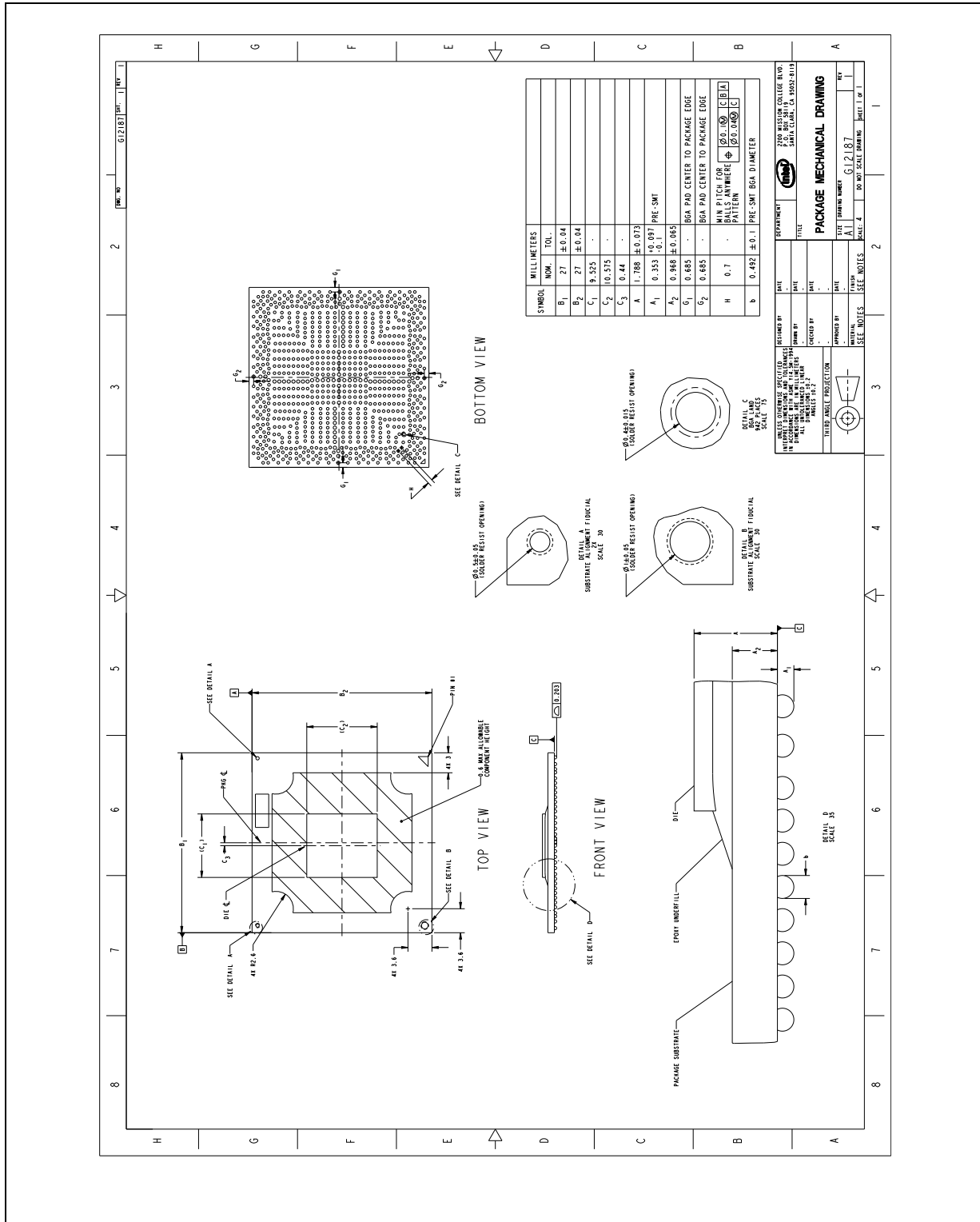

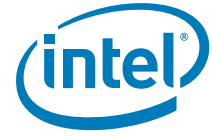

7.2 Mobile PCH Package

- FCBGA package
- Package size: 25 mm x 25 mm
- Ball Count: 989
- Ball pitch: 0.6 mm

The Mobile PCH package information is shown in [Figure 7-2](#)

Note: All dimensions, unless otherwise specified, are in millimeters.

Figure 7-2. Mobile PCH Package Drawing

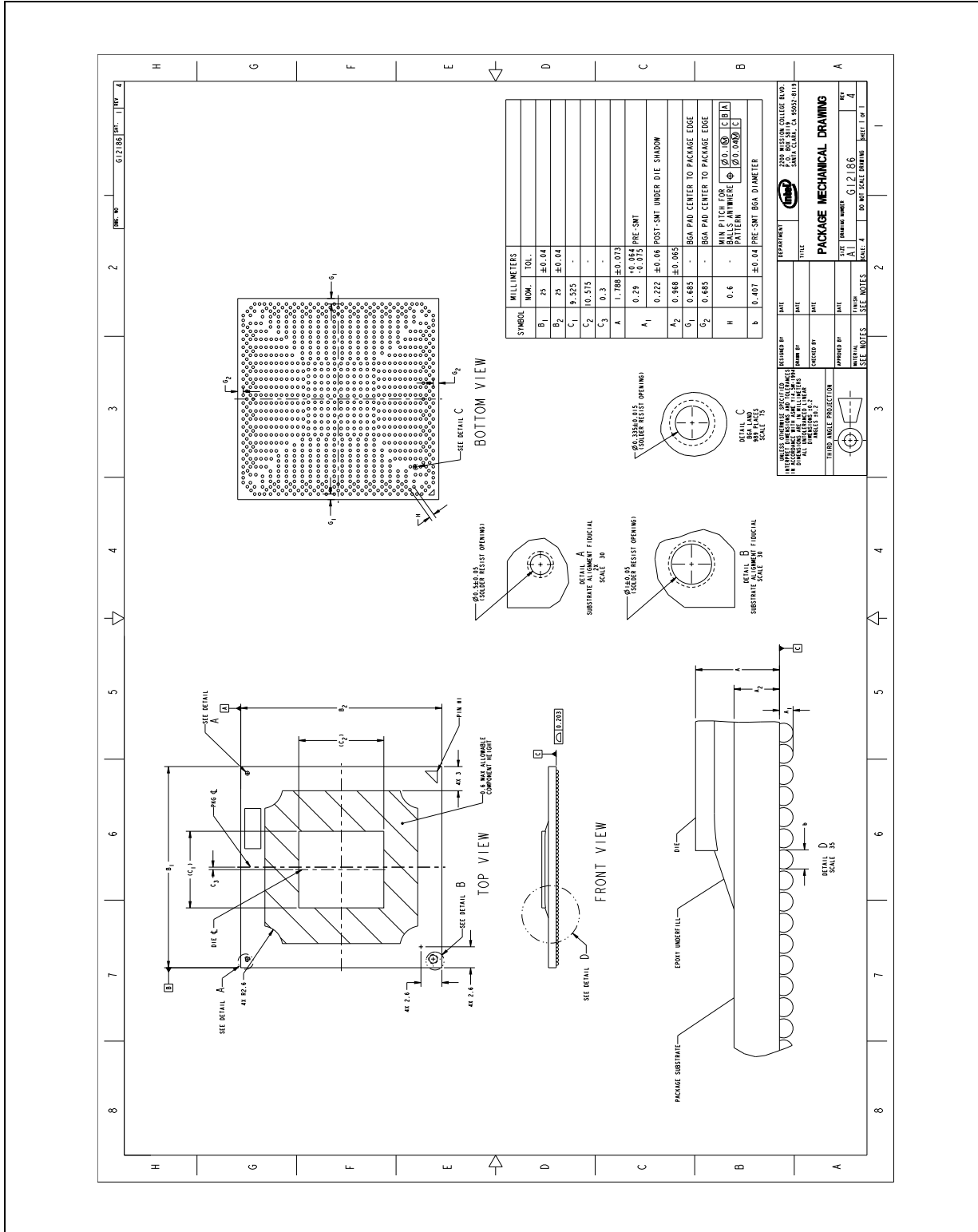

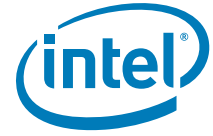

7.3 Mobile SFF PCH Package

- FCBGA package
- Package size: 22 mm x 22 mm
- Ball Count: 1017
- Ball pitch: 0.59 mm

The Mobile SFF PCH package information is shown in [Figure 7-3](#)

Note: All dimensions, unless otherwise specified, are in millimeters.

Figure 7-3. Mobile SFF PCH Package Drawing

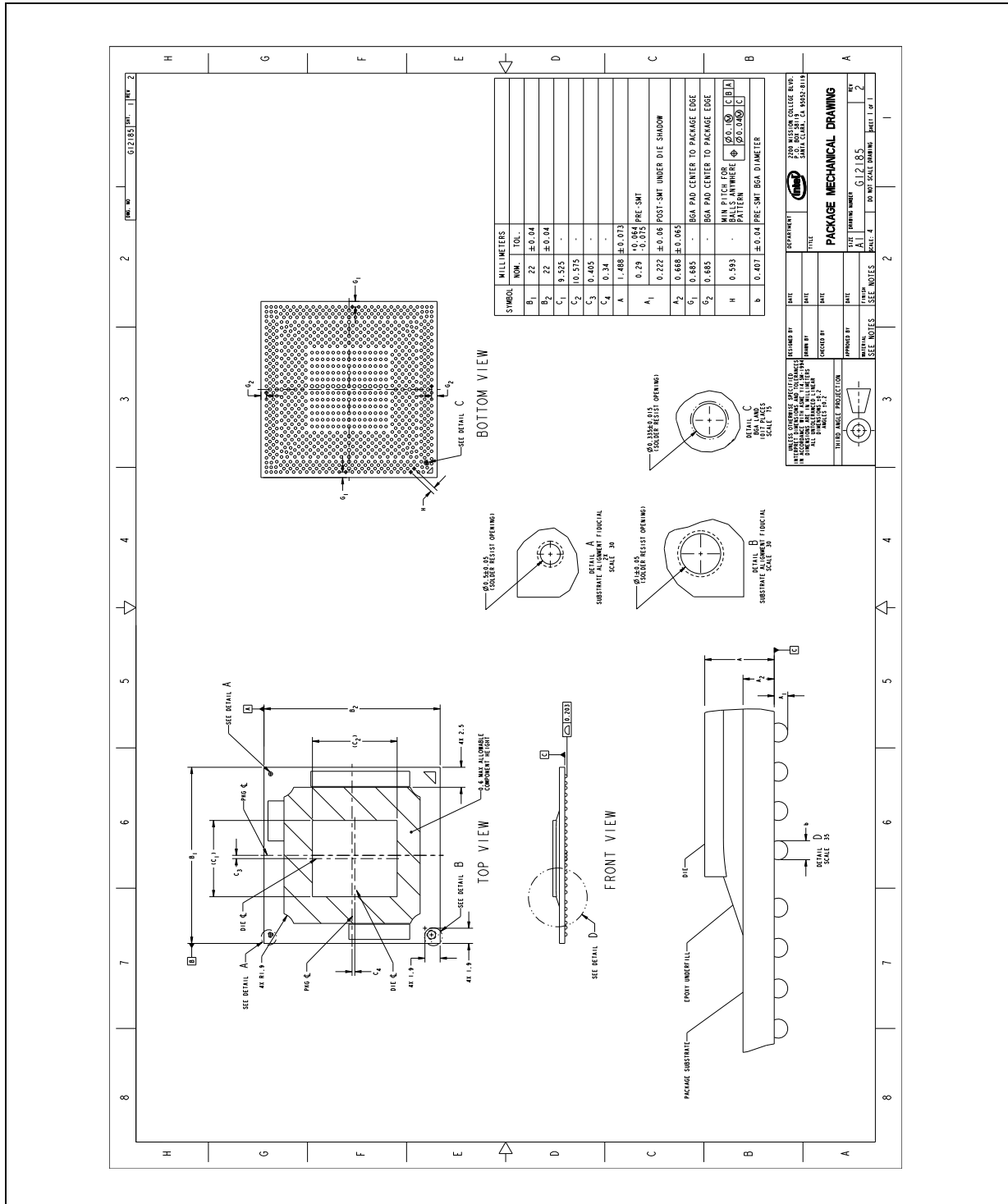



8 Electrical Characteristics

This chapter contains the DC and AC characteristics for the PCH. AC timing diagrams are included.

8.1 Thermal Specifications

8.1.1 Desktop Storage Specifications and Thermal Design Power (TDP)

For desktop thermal information, refer to the *Intel® 6 Series Chipset and UP Server / Workstation Platform Controller Hub (PCH) – Thermal and Mechanical Specifications Design Guide*

8.1.2 Mobile Storage Specifications and Thermal Design Power (TDP)

Table 8-1. Storage Conditions and Thermal Junction Operating Temperature Limits

Parameter	Description	Min	Max	Notes
T _{ABSOLUTE STORAGE}	The non-operating device storage temperature. Damage (latent or otherwise) may occur when exceeded for any length of time.	-25 °C	125 °C	1,2,3
T _{SUSTAINED STORAGE}	The ambient storage temperature (in shipping media) for a sustained period of time.	-5 °C	40 °C	4,5
RH _{SUSTAINED STORAGE}	The maximum device storage relative humidity for a sustained period of time.	60% @ 24 °C		5,6
TIME _{SUSTAINED STORAGE}	A prolonged or extended period of time; typically associated with customer shelf life.	0 Months	6 Months	6
T _j (Mobile Only)	Mobile Thermal Junction Operating Temperature limits	0 °C	108 °C	7

NOTES:

- Refers to a component device that is not assembled in a board or socket and is not electrically connected to a voltage reference or I/O signal.
- Specified temperatures are not to exceed values based on data collected. Exceptions for surface mount reflow are specified by the applicable JEDEC standard. Non-adherence may affect PCH reliability.
- T_{ABSOLUTE STORAGE} applies to the unassembled component only and does not apply to the shipping media, moisture barrier bags, or desiccant.
- Intel branded products are specified and certified to meet the following temperature and humidity limits that are given as an example only (Non-Operating Temperature Limit: -40 °C to 70 °C and Humidity: 50% to 90%, non-condensing with a maximum wet bulb of 28 °C.) Post board attach storage temperature limits are not specified for non-Intel branded boards.
- The JEDEC J-JSTD-020 moisture level rating and associated handling practices apply to all moisture sensitive devices removed from the moisture barrier bag.



6. Nominal temperature and humidity conditions and durations are given and tested within the constraints imposed by $T_{\text{SUSTAINED}}$ storage and customer shelf life in applicable Intel boxes and bags.
7. The thermal solution needs to ensure that the temperature does not exceed the maximum junction temperature ($T_{j,\text{max}}$) limit.

Table 8-2. Mobile Thermal Design Power

SKU	Thermal Design Power (TDP)	Notes
Standard	3.9 W	
SFF	3.4 W	
Low Power (Intel® UM67 Chipset)	3.4 W	

8.2 Absolute Maximum Ratings

Table 8-3. PCH Absolute Maximum Ratings

Parameter	Maximum Limits
Voltage on any 5 V Tolerant Pin with respect to Ground ($V_{5\text{REF}} = 5\text{ V}$)	-0.5 to $V_{5\text{REF}} + 0.5\text{ V}$
Voltage on any 3.3 V Pin with respect to Ground	-0.5 to $V_{\text{cc}3_3} + 0.4\text{ V}$
Voltage on any 1.8 V Tolerant Pin with respect to Ground	-0.5 to $V_{\text{ccVRM}} + 0.5\text{ V}$
Voltage on any 1.5 V Pin with respect to Ground	-0.5 to $V_{\text{ccVRM}} + 0.5\text{ V}$
Voltage on any 1.05 V Tolerant Pin with respect to Ground	-0.5 to $V_{\text{ccCore}} + 0.5\text{ V}$
1.05 V Supply Voltage with respect to VSS	-0.5 to 1.3 V
1.8 V Supply Voltage with respect to VSS	-0.5 to 1.98 V
3.3 V Supply Voltage with respect to VSS	-0.5 to 3.7 V
5.0 V Supply Voltage with respect to VSS	-0.5 to 5.5 V
$V_{\text{PROC_IO}}$ Supply Voltage with respect to VSS	-0.5 to 1.3 V
1.5 V Supply Voltage for the analog PLL with respect to VSS	-0.5 to 1.65 V
1.8 V Supply Voltage for the analog PLL with respect to VSS	-0.5 to 1.98 V

Table 8-3 specifies absolute maximum and minimum ratings. At conditions outside functional operation condition limits, but within absolute maximum and minimum ratings, neither functionality nor long-term reliability can be expected. If a device is returned to conditions within functional operation limits after having been subjected to conditions outside these limits (but within the absolute maximum and minimum ratings) the device may be functional, but with its lifetime degraded depending on exposure to conditions exceeding the functional operation condition limits.

At conditions exceeding absolute maximum and minimum ratings, neither functionality nor long-term reliability can be expected. Moreover, if a device is subjected to these conditions for any length of time, it will either not function or its reliability will be severely degraded when returned to conditions within the functional operating condition limits.

Although the PCH contains protective circuitry to resist damage from Electrostatic Discharge (ESD), precautions should always be taken to avoid high static voltages or electric fields.



8.3 PCH Power Supply Range

Table 8-4. PCH Power Supply Range

Power Supply	Minimum	Nominal	Maximum
1.0 V	0.95 V	1.00 V	1.05 V
1.05 V	1.00 V	1.05 V	1.10 V
1.5 V	1.43 V	1.50 V	1.58 V
1.8 V	1.71 V	1.80 V	1.89 V
3.3 V	3.14 V	3.30 V	3.47 V
5 V	4.75 V	5.00 V	5.25 V

8.4 General DC Characteristics

Table 8-5. Measured I_{CC} (Desktop Only)

Voltage Rail	Voltage (V)	S0 I _{ccmax} Current Integrated Graphics ⁵ (A)	S0 I _{ccmax} Current External Graphics ⁵ (A)	S0 Idle Current Integrated Graphics ^{4,5} (A)	S0 Idle Current External Graphics ⁵ (A)	S _x I _{ccmax} Current ⁵ (A)	S _x Idle Current (A)	G3
V_PROC_IO	1.05 / 1.0	0.001	0.001	0.001	0.001	0	0	—
V5REF	5	0.001	0.001	0.001	0.001	0	0	—
V5REF_Sus	5	0.001	0.001	0.001	0.001	0.001	0.001	—
Vcc3_3	3.3	0.267	0.267	0.047	0.047	0	0	—
VccADAC ³	3.3	0.068	0.001	0.001	0.001	0	0	—
VccADPLLA	1.05	0.08	0.02	0.065	0.005	0	0	—
VccADPLLB	1.05	0.08	0.02	0.01	0.01	0	0	—
VccCore	1.05	2.1	1.94	0.6	0.42	0	0	—
VccDMI	1.05	0.057	0.057	0.002	0.002	0	0	—
VccIO ³	1.05	4.35	3.69	0.86	0.53	0	0	—
VccASW	1.05	1.31	1.31	0.353	0.353	0.703	0.350	—
VccSPI	3.3	0.02	0.02	0.001	0.001	0.015	0.001	—
VccDSW3_3	3.3	0.002	0.002	0.001	0.001	0.002	0.001	—
VccDFTERM	1.8	0.002	0.002	0.001	0.001	0	0	—
VccRTC	3.3	N/A	N/A	N/A	N/A	N/A	N/A	6 μA See notes 1, 2
VccSus3_3	3.3	0.097	0.097	0.009	0.009	0.142	0.033	—
VccSusHDA	3.3	0.01	0.01	0.001	0.001	0.001	0.001	—
VccVRM	1.8	0.175	0.135	0.129	0.089	0	0	—
VccClkDMI	1.05	0.08	0.08	0.08	0.08	0	0	—
VccSSC	1.05	0.105	0.105	0.03	0.03	0	0	—
VccDIFFCLKN	1.05	0.055	0.055	0.05	0.05	0	0	—

NOTES:

1. G3 state shown to provide an estimate of battery life.

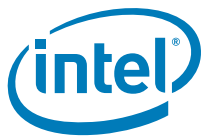

2. Icc (RTC) data is taken with VccRTC at 3.0 V while the system in a mechanical off (G3) state at room temperature.
3. Numbers based on a worst-case of 3 displays - 2 DisplayPort and 1 CRT, even though only 2 display pipes are enabled at any one time. If no CRT is used, VccADAC contribution can be ignored.
4. S0 Idle is based on 1 DisplayPort Panel used on Display Pipe A.
5. S0 Iccmax Measurements taken at 110 °C and S0 Idle/Sx Iccmax measurements taken at 50 °C.

Table 8-6. Measured I_{CC} (Mobile Only) (Sheet 1 of 2)

Voltage Rail	Voltage (V)	S0 Iccmax Current Integrated Graphics ⁵ (A)	S0 Iccmax Current External Graphics ⁵ (A)	S0 Idle Current Integrated Graphics ^{4,5} (A)	S0 Idle Current External Graphics ⁵ (A)	Sx Iccmax Current ⁵ (A)	Sx Idle Current (A)	G3
V_PROC_IO	1.05 / 1.0	0.001	0.001	0.001	0.001	0	0	—
V5REF	5	0.001	0.001	0.001	0.001	0	0	—
V5REF_Sus	5	0.001	0.001	0.001	0.001	0.001	0.001	—
Vcc3_3	3.3	0.228	0.228	0.035	0.035	0	0	—
VccADAC3	3.3	0.001	0.001	0.001	0.001	0	0	—
VccADPLLA	1.05	0.075	0.01	0.07	0.005	0	0	—
VccADPLLB	1.05	0.075	0.01	0.01	0.005	0	0	—
VccCore (Internal Suspend VR mode using INTVRMEN)	1.05	1.3	1.14	0.36	0.28	0	0	—
VccCore (External Suspend VR mode using INTVRMEN)	1.05	1.2	1.04	0.31	0.23	0	0	—
VccDMI	1.05 / 1.0	0.042	0.042	0.001	0.001	0	0	—
VccIO3	1.05	3.709	3.187	0.458	0.319	0	0	—
VccASW	1.05	0.903	0.903	0.203	0.203	0.603	0.23	—
VccSPI	3.3	0.01	0.01	0.001	0.001	0.01	0.01	—
VccDSW3_3	3.3	0.001	0.001	0.001	0.001	0.003	0.001	—
VccDFTERM	1.8	0.002	0.002	0.001	0.001	0	0	—
VccRTC	3.3	N/A	N/A	N/A	N/A	N/A	N/A	6 uA See notes 1, 2
VccSus3_3 (Internal Suspend VR mode using INTVRMEN)	3.3	0.065	0.065	0.009	0.009	0.119	0.031	—

**Table 8-6. Measured I_{CC} (Mobile Only) (Sheet 2 of 2)**

Voltage Rail	Voltage (V)	S0 Iccmax Current Integrated Graphics ⁵ (A)	S0 Iccmax Current External Graphics ⁵ (A)	S0 Idle Current Integrated Graphics ^{4,5} (A)	S0 Idle Current External Graphics ⁵ (A)	Sx Iccmax Current ⁵ (A)	Sx Idle Current (A)	G3
VccSus3_3 (External Suspend VR mode using INTVRMEN)	3.3	0.065	0.065	0.005	0.005	0.059	0.014	—
VccSusHDA	3.3	0.01	0.01	0.001	0.001	0.001	0.001	—
VccVRM	1.5	0.167	0.127	0.124	0.075	0	0	—
VccClkDMI	1.05	0.075	0.075	0.065	0.065	0	0	
VccSSC	1.05	0.095	0.095	0.095	0.095	0	0	
VccDIFFCLKN	1.05	0.055	0.055	0.05	0.05	0	0	
VccALVDS	3.3	0.001	0.001	0.001	0.001	0	0	
VccTX_LVDS ³	1.8	0.04	0.001	0.04	0.001	0	0	
DcpSus (External Suspend VR mode using INTVRMEN) ⁶	1.05	0.1	0.1	0.05	0.05	0.06	0.017	

NOTES:

- G3 state shown to provide an estimate of battery life
- Icc (RTC) data is taken with VccRTC at 3.0 V while the system in a mechanical off (G3) state at room temperature.
- Numbers based on 2 Display configuration - 1 external DisplayPort and 1 LVDS display. If VGA is used, VccADAC S0 Iccmax in Integrated Graphics contribution is 63 mA.
- S0 Idle is based on 1 LVDS display used on Display Pipe A.
- S0 Iccmax Measurements taken at 110°C and S0 Idle/Sx Iccmax measurements taken at 50°C.
- This applies to External Suspend VR powered mode for DcpSus. In Internal Suspend VR mode, DcpSus is a No Connect and hence Iccmax is not applicable.
- Sx Idle current measurement is based on Sx/M3 and assumes VccASW is powered

Table 8-7. DC Characteristic Input Signal Association (Sheet 1 of 2)

Symbol	Associated Signals
VIH1/VIL1 (5V Tolerant)	PCI Signals (Desktop Only): AD[31:0], C/BE[3:0]#, DEVSEL#, FRAME#, IRDY#, PAR, PERR#, PLOCK#, REQ[3:0]#, SERR#, STOP#, TRDY# Interrupt Signals: PIRQ[D:A]#, PIRQ[H:E]# GPIO Signals: GPIO[54, 52, 50, 5:2]
VIH2/VIL2	Digital Display Port Hot Plug Detect: DDPB_HPD, DDPD_HPD, DDPD_HPD
VIH3/VIL3	Power Management Signals: PWRBTN#, RI#, SYS_RESET#, WAKE#, SUSACK# Mobile Only: AC_PRESENT, CLKRUN# GPIO Signals: GPIO[71:61, 57, 48, 39, 38, 34, 31:29, 24, 22, 17, 7, 6, 1] Desktop Only: GPIO32 Thermal/Fan Control Signals: TACH[7:0] (Server/Workstation Only)
VIH4/VIL4	Clock Signals: CLKIN_PCILOOPBACK, PCIECLKRQ[7:6]#, PCIECLKRQ[2], PCIECLKRQ[5] Mobile Only: PEG_A_CLKRQ#, PEG_B_CLKRQ#, PCIECLKRQ[1:0], PCIECLKRQ[4:3] Processor Signals: A20GATE PCI Signals: PME# Interrupt Signals: SERIRQ Power Management Signals: BMBUSY# Mobile Only: BATLOW# SATA Signals: SATA[5:0]GP SPI Signals: SPI_MISO Strap Signals: SPKR, GNT[3:1]#, (Strap purposes only) LPC/Firmware Hub Signals: LAD[3:0]/FWH[3:0], LDRQ0#, LDRQ1#, GPIO Signals: GPIO[73, 72, 59, 56, 55, 53, 51, 49, 47:40, 37:35, 33, 28:25, 23, 21:18, 16:14, 10:8, 0] Desktop Only: GPIO12 USB Signals: OC[7:0]#
VIH5/VIL5	SMBus Signals: SMBCLK, SMBDATA, SMBALERT# System Management Signals: SML[1:0]CLK(1), SML[1:0]DATA(1) GPIO Signals: GPIO[75, 74, 60, 58, 11]
VIH6/VIL6	JTAG Signals: JTAG_TDI, JTAG_TMS, JTAG_TCK
VIH7/VIL7	Processor Signals: THRMTRIP#
VIMIN8Gen1/ VIMAX8Gen1, VIMIN8Gen2/ VIMAX8Gen2	PCI Express* Data RX Signals: PER[p,n][8:1] (2.5 GT/s and 5.0 GT/s)
VIH9/VIL9	Real Time Clock Signals: RTCX1
VIMIN10 -Gen1i/ VIMAX10-Gen1i	SATA Signals: SATA[5:0]RX[P,N] (1.5 Gb/s internal SATA)
VIMIN10 -Gen1m/ VIMAX10-Gen1m	SATA Signals: SATA[5:0]RX[P,N] (1.5 Gb/s external SATA)
VIMIN10 -Gen2i/ VIMAX10-Gen2i	SATA Signals: SATA[5:0]RX[P,N] (3.0 Gb/s internal SATA)
VIMIN10 -Gen2m/ VIMAX10-Gen2m	SATA Signals: SATA[5:0]RX[P,N] (3.0 Gb/s external SATA)



Table 8-7. DC Characteristic Input Signal Association (Sheet 2 of 2)

Symbol	Associated Signals
VIH11/VIL11	Intel High Definition Audio Signals: HDA_SDIN[3:0] (3.3V Mode) Strap Signals: HDA_SDO, HDA_SYNC (Strap purposes only) GPIO Signals: GPIO13 NOTE: See VIL_HDA/VIH_HDA for High Definition Audio Low Voltage Mode
VIH12 (Absolute Maximum) / VIL12 (Absolute Minimum) / Vclk_in_cross(abs)	Clock Signals: CLKIN_DMI_[P,N], CLKIN_DOT96[P,N], CLKIN_SATA_[P,N]]
VIH13/VIL13	Miscellaneous Signals: RTCRST#
VIH14/VIL14	Power Management Signals: PWROK, RSMRST#, DPWROK System Management Signals: INTRUDER# Miscellaneous Signals: INTVRMEN, SRTCST#
VIH15/VIL15	Digital Display Control Signals: CRT_DDC_CLK, CRT_DDC_DATA, SDVO_CTRLCLK, SDVO_CTRLDATA, DDPC_CTRLCLK, DDPC_CTRLDATA, DDPD_CTRLCLK, DDPD_CTRLDATA Mobile only: L_BKLTEN, L_BKLTCTL, L_DDC_CLK, L_DDC_DATA
VIH16/VIL16	Processor Interface: RCIN# Power Management Signals: SYS_PWROK, APWROK
VIH_CL/VIL_CL	Controller Link: CL_CLK1, CL_DATA1
VDI / VCM / VSE (5V Tolerant)	USB Signals: USBP[13:0][P,N] (Low-speed and Full-speed)
VHSSQ / VHSOSC / VHSCM (5V Tolerant)	USB Signals: USBP[13:0][P,N] (in High-speed Mode)
VIH_HDA / VIL_HDA	Intel® High Definition Audio Signals: HDA_SDIN[3:0] Strap Signals: HDA_SDO, HDA_SYNC (Strap purposes only) NOTE: Only applies when running in Low Voltage Mode (1.5 V)
VIH_SST/VIL_SST	SST (Server/Workstation Only)
VIH_FDI/VIL_FDI	Intel® Flexible Display Interface Signals: FDI_RX[P,N][7:0]
VAUX-Diff-P-P	Digital Display Port Aux Signal (Receiving Side): DDP[D:B]_AUX[P,N]
VIH_XTAL25/VIL_XTAL25	25MHz Crystal Input XTAL25_IN
VIMIN17-Gen3i/VIMAX17-Gen3i	SATA Signals: SATA[5:0]RX[P,N] (6.0 Gb/s internal SATA)

NOTES:

- $V_{DI} = |USBP_x[P] - USBP_x[N]|$
- Includes VDI range
- Applies to Low-Speed/High-Speed USB
- PCI Express mVdiff p-p = $2 * |PETp[x] - PETn[x]|$
- SATA Vdiff, RX (VIMAX10/MIN10) is measured at the SATA connector on the receiver side (generally, the motherboard connector), where SATA mVdiff p-p = $2 * |SATA[x]RXP - SATA[x]RXN|$
- VccRTC is the voltage applied to the VccRTC well of the PCH. When the system is in a G3 state, this is generally supplied by the coin cell battery, but for S5 and greater, this is generally VccSus3_3.
- $CL_Vref = 0.12 * (VccSus3_3)$
- This is an AC characteristic that represents transient values for these signals.
- Applies to High-Speed USB 2.0.



Table 8-8. DC Input Characteristics (Sheet 1 of 3)

Symbol	Parameter	Min	Max	Unit	Notes
VIL1	Input Low Voltage	-0.5	0.3 × 3.3 V	V	10
VIH1	Input High Voltage	0.5 × 3.3 V	V5REF + 0.5	V	10
VIL2	Input Low Voltage	—	.8	V	
VIH2	Input High Voltage	2	—	V	
VIL3	Input Low Voltage	-0.5	0.8	V	
VIH3	Input High Voltage	2.0	3.3 V + 0.5	V	10
VIL4	Input Low Voltage	-0.5	0.3 × 3.3 V	V	10
VIH4	Input High Voltage	0.5 × 3.3 V	3.3 V + 0.5	V	10
VIL5	Input Low Voltage	0	0.8	V	
VIH5	Input High Voltage	2.1	3.3 V + 0.5	V	10
VIL6	Input Low Voltage	-0.5	0.35	V	11
VIH6	Input High Voltage	0.75	1.05 V + 0.5	V	11
VIL7	Input Low Voltage	0	0.25 × V_PROC_IO	V	
VIH7	Input High Voltage	0.75 × V_PROC_IO	V_PROC_IO	V	
VIMIN8Gen1	Minimum Input Voltage	175	—	mVdiffp-p	4
VIMAX8Gen1	Maximum Input Voltage	—	1200	mVdiffp-p	4
VIMIN8Gen2	Minimum Input Voltage	100	—	mVdiffp-p	4
VIMAX8Gen2	Maximum Input Voltage	—	1200	mVdiffp-p	4
VIL9	Input Low Voltage	-0.5	0.10	V	
VIH9	Input High Voltage	0.50	1.2	V	
VIMIN10-Gen1i	Minimum Input Voltage - 1.5 Gb/s internal SATA	325	—	mVdiffp-p	5
VIMAX10-Gen1i	Maximum Input Voltage - 1.5 Gb/s internal SATA	—	600	mVdiffp-p	5
VIMIN10-Gen1m	Minimum Input Voltage - 1.5 Gb/s eSATA	240	—	mVdiffp-p	5
VIMAX10-Gen1m	Maximum Input Voltage - 1.5 Gb/s eSATA	—	600	mVdiffp-p	5
VIMIN10-Gen2i	Minimum Input Voltage - 3.0 Gb/s internal SATA	275	—	mVdiffp-p	5
VIMAX10-Gen2i	Maximum Input Voltage - 3.0 Gb/s internal SATA	—	750	mVdiffp-p	5
VIMIN10-Gen2m	Minimum Input Voltage - 3.0 Gb/s eSATA	240	—	mVdiffp-p	5
VIMAX10-Gen2m	Maximum Input Voltage - 3.0 Gb/s eSATA	—	750	mVdiffp-p	5
VIL11	Input Low Voltage	0	0.35 × 3.3 V	V	10
VIH11	Input High Voltage	0.65 × 3.3 V	3.3 + 0.5V	V	10
VIL12 (Absolute Minimum)	Input Low Voltage	-0.3	—	V	

**Table 8-8. DC Input Characteristics (Sheet 2 of 3)**

Symbol	Parameter	Min	Max	Unit	Notes
VIH12 (Absolute Maximum)	Input High Voltage	—	1.150	V	
VIL13	Input Low Voltage	-0.5	0.78	V	
VIH13	Input High Voltage	2.3	V _{ccRTC} + 0.5	V	6
VIL14	Input Low Voltage	-0.5	0.78	V	
VIH14	Input High Voltage	2.0	V _{ccRTC} + 0.5	V	6
VIL15	Input Low Voltage	-0.5	0.3 × 3.3 V	V	10
VIH15	Input High Voltage	0.7 × 3.3 V	3.3 V + 0.5	V	10
VIL16	Input Low Voltage	-0.5	0.8	V	10
VIH16	Input High Voltage	2.1	3.3 V + 0.5	V	10
VIL_CL	Input Low Voltage	-0.3	CL_VREF - 0.075	V	7
VIH_CL	Input High Voltage	CL_VREF + 0.075	1.2	V	7
Vclk_in_cross (abs)	Absolute Crossing Point	0.250	0.550	V	
VDI	Differential Input Sensitivity	0.2	—	V	1,3
VCM	Differential Common Mode Range	0.8	2.5	V	2,3
VSE	Single-Ended Receiver Threshold	0.8	2.0	V	3
VHSSQ	HS Squelch Detection Threshold	100	150	mV	9
VHSDSC	HS Disconnect Detection Threshold	525	625	mV	9
VHSCM	HS Data Signaling Common Mode Voltage Range	-50	500	mV	9
VIL_HDA	Input Low Voltage	0	0.4 × V _{cc_HDA}	V	
VIH_HDA	Input High Voltage	0.6 × V _{cc_HDA}	1.5	V	
VIL_SST (Server/ Workstation Only)	Input Low Voltage	-0.3	0.4	V	
VIH_SST (Server/ Workstation Only)	Input High Voltage	1.1	1.5	V	
VIL_PECI	Input Low Voltage	-0.15	0.275 × V _{PROC_IO}	V	
VIH_PECI	Input High Voltage	0.725 × V _{PROC_IO}	V _{PROC_IO} + 0.15	V	
VIL_FDI	Minimum Input Voltage	175	—	mV _{diffp-p}	
VIH_FDI	Maximum Input Voltage	—	1000	mV _{diffp-p}	



Table 8-8. DC Input Characteristics (Sheet 3 of 3)

Symbol	Parameter	Min	Max	Unit	Notes
VAUX-Diff-P-P	Digital Display Port Auxiliary Signal peak-to-peak voltage at receiving device	0.32	1.36	Vdiffp-p	
VIL_XTAL25	Minimum Input Voltage	-0.25	0.15	V	12
VIH_XTAL25	Maximum Input Voltage	0.7	1.2	V	12
VIMIN17-Gen3i	Minimum Input Voltage - 6.0 Gb/s internal SATA	240	—	mVdiffp-p	5
VIMAX17-Gen3i	Maximum Input Voltage - 6.0 Gb/s internal SATA	—	1000	mVdiffp-p	5

NOTES:

- $V_{Di} = |USBx[P] - USBx[N]|$
- Includes VDI range
- Applies to Low-Speed/Full-Speed USB
- PCI Express mVdiff p-p = $2 * |PETp[x] - PETn[x]|$
- SATA Vdiff, RX (VIMAX10/MIN10) is measured at the SATA connector on the receiver side (generally, the motherboard connector), where SATA mVdiff p-p = $2 * |SATA[x]RXP - SATA[x]RXN|$.
- VccRTC is the voltage applied to the VccRTC well of the PCH. When the system is in a G3 state, this is generally supplied by the coin cell battery, but for S5 and greater, this is generally VccSus3_3.
- CL_Vref = $0.12 * (VccSus3_3)$.
- This is an AC Characteristic that represents transient values for these signals.
- Applies to High-Speed USB 2.0.
- 3.3 V refers to VccSus3_3 for signals in the suspend well, Vcc3_3 for signals in the core well and to VccDSW3_3 for signals in the DSW well. See [Table 3-2](#), or [Table 3-3](#) for signal and power well association.
- 1.05 V refers to VccIO or VccCore for signals in the core well and to VccASW for signals in the ME well. See [Table 3-2](#) or [Table 3-3](#) for signal and power well association.
- Vpk-pk min for XTAL25 = 500 mV.

**Table 8-9. DC Characteristic Output Signal Association (Sheet 1 of 2)**

Symbol	Associated Signals
VOH1/VOL1	Processor Signal: PMSYNCH, PROCPWRGD
VOH2/VOL2	<p>LPC/Firmware Hub Signals: LAD[3:0]/FWH[3:0], LFRAME#/FWH[4], INIT3_3V#</p> <p>Power Management Signal: LAN_PHY_PWR_CTRL</p> <p>Intel® High Definition Audio Signals: HDA_DOCK_EN# (Mobile Only), HDA_DOCK_RST# (Mobile Only)</p> <p>PCI Signals: AD[31:0], C/BE[3:0], DEVSEL#, FRAME#, IRDY#, PAR, PCIRST#, GNT[3:0]#, PME#(1)</p> <p>Interrupt Signals: PIRQ[D:A], PIRQ[H:E]#(1)</p> <p>GPIO Signals: GPIO[73, 72, 59, 56, 55:50, 49, 47:40, 37:35, 33, 28:25, 23, 21:18, 16:12, 10:8, 5:2, 0]</p> <p>SPI Signals: SPI_CS0#, SPI_CS1#, SPI_MOSI, SPI_CLK</p> <p>Miscellaneous Signals: SPKR</p>
VOH3/VOL3	<p>SMBus Signals: SMBCLK(1), SMBDATA(1)</p> <p>System Management Signals: SML[1:0]CLK(1), SML[1:0]DATA(1), SML0ALERT#, SML1ALERT#</p> <p>GPIO Signals: GPIO[75, 74, 60, 58, 11]</p>
VOH4/VOL4	<p>Power Management Signals: SLP_S3#, SLP_S4#, SLP_S5#, SLP_A#, SLP_LAN#, SUSCLK, SUS_STAT#, SUSPWRDNACK, SLP_SUS#, STP_PCI# Mobile Only: CLKRUN#</p> <p>SATA Signals: SATALED#, SCLOCK, SLOAD, SDATAOUT0, SDATAOUT1</p> <p>GPIO Signals: GPIO[71:68, 63:61, 57, 48, 39, 38, 34, 31, 30, 29, 24, 22, 17, 7, 6, 1] Desktop Only: GPIO32</p> <p>Controller Link: CL_RST1#</p> <p>Interrupt Signals: SERIRQ</p>
VOH5/VOL5	USB Signals: USBP[13:0][P,N] in Low-speed and Full-speed Modes
VOL6/VOL6 (Fast Mode)	<p>Digital Display Control Signals: CRT_DDC_CLK, CRT_DDC_DATA, SDVO_CTRLCLK, SDVO_CTRLDATA, DDPC_CTRLCLK, DDPC_CTRLDATA, DDPD_CTRLCLK, DDPD_CTRLDATA</p> <p>Mobile only: L_CTRL_CLK, L_CTRL_DATA, L_VDD_EN, L_BKLTEN, L_BKLTCTL, L_DDC_CLK, L_DDC_DATA,</p> <p>NOTE: Fast Mode is not applicable to L_VDD_EN</p>
VOH6	L_VDD_EN, L_BKLTEN, L_BKLTCTL
VOMIN7 -Gen1i,m/ VOMAX7-Gen1i,m	SATA Signals: SATA[5:0]RX[P,N] (1.5 Gb/s Internal and External SATA)
VOMIN7 -Gen2i,m/ VOMAX7-Gen2i,m	SATA Signals: SATA[5:0]RX[P,N] (3.0 Gb/s Internal and External SATA)
VOMIN8/VOMAX8	<p>Digital Display Ports when configured as HDMI/DVI: DDPB_[3:0][P,N], DDPC_[3:0][P,N], DDPD_[3:0][P,N]</p> <p>SDVO Signals: SDVO_INT[P,N], SDVO_TVCLKIN[P,N], SDVO_STALL[P,N]</p>
VOH9/VOL9	Power Management Signal: PLTRST#

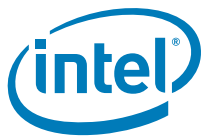

Table 8-9. DC Characteristic Output Signal Association (Sheet 2 of 2)

Symbol	Associated Signals
VHSOI VHSOH VHSOL VCHIRPJ VCHIRPK	USB Signals: USBP[13:0][P:N] in High-speed Mode
VOH_HDA/ VOL_HDA	Intel® High Definition Audio Signals: HDA_RST#, HDA_SDO, HDA_SYNC
VOL_JTAG	JTAG Signals: JTAG_TDO
VOH_PCICLK/ VOL_PCICLK	Single Ended Clock Interface Output Signals: CLKOUT_PCI[4:0], CLKOUTFLEX[3:0] GPIO Signals: [67:64]
VOL_SGPIO	SGPIO Signals: SCLOCK, SLOAD, SDATAOUT0, SDATAOUT1
VOH_PWM/ VOL_PWM	Thermal and Fan Control Signals: PWM[3:0] (Server/Workstation Only)
VOH_CRT/VOL_CRT	Display Signals: CRT_HSYNC, CRT_VSYNC
VOH_CL1/VOL_CL1	Controller Link Signals: CL_CLK1, CL_DATA1
VOH_SST/VOL_SST (Server/Workstation Only)	SST signal: SST
VAUX-Diff-P-P	Digital Display Port Aux Signal (Transmit Side): DDP[D:B]_AUX[P,N]
VOH_FDI//VOL_FDI	Intel® FDI signals: FDI_FSYNC_[1:0],FDI_LSYNC_[1:0],FDI_INT
VOMIN10 -Gen3i/ VOMAX10-Gen3i	SATA Signals: SATA[5:0]RX[P,N] (6.0 Gb/s Internal SATA)
VOMIN11- PCIeGen12 VOMAX11- PCIeGen12	PCI Express* Data TX Signals: PET[p,n][8:1] (Gen1 and Gen2)

NOTE:

1. These signals are open-drain.



Table 8-10. DC Output Characteristics (Sheet 1 of 2)

Symbol	Parameter	Min	Max	Unit	I_{OL} / I_{OH}	Notes
VOL1	Output Low Voltage	0	0.255	V	3 mA	
VOH1	Output High Voltage	$V_{PROC_IO} - 0.3$	V_{PROC_IO}	V	-3 mA	
VOL2	Output Low Voltage	—	0.1×3.3 V	V	1.5 mA	7
VOH2	Output High Voltage	0.9×3.3 V	3.3	V	-0.5 mA	7
VOL3	Output Low Voltage	0	0.4	V	3 mA	
VOH3	Output High Voltage	3.3 V - 0.5	—	V	4 mA	1, 7
VOL4	Output Low Voltage	—	0.4	V	6 mA	
VOH4	Output High Voltage	3.3 V - 0.5	3.3 V	V	-2 mA	7
VOL5	Output Low Voltage	—	0.4	V	5 mA	
VOH5	Output High Voltage	3.3 V - 0.5	—	V	-2 mA	7
VOL6	Output Low Voltage	0	400	mV	3 mA	2
VOL6 (Fast Mode)	Output Low Voltage	0	600	mV	6 mA	2
VOH6	Output High Voltage	3.3 V - 0.5	3.3	V	-2 mA	7, 2
VOMIN7-Gen1i,m	Minimum Output Voltage	400	—	mVdif fp-p		3
VOMAX7-Gen1i,m	Maximum Output Voltage	—	600	mVdif fp-p		3
VOMIN7-Gen2i,m	Minimum Output Voltage	400	—	mVdif fp-p		3
VOMAX7-Gen2i,m	Maximum Output Voltage	—	700	mVdif fp-p		3
VOMIN8	Output Low Voltage	400	—	mVdif fp-p		
VOMAX8	Output High Voltage	—	600	mVdif fp-p		
VOL9	Output Low Voltage	—	0.1×3.3 V	V	1.5 mA	7
VOH9	Output High Voltage	0.9×3.3 V	3.3	V	-2.0 mA	7
VHSOI	HS Idle Level	-10.0	10.0	mV		
VHSOH	HS Data Signaling High	360	440	mV		
VHSOL	HS Data Signaling Low	-10.0	10.0	mV		
VCHIRPJ	Chirp J Level	700	1100	mV		
VCHIRPK	Chirp K Level	-900	-500	mV		
VOL_HDA	Output Low Voltage	—	$0.1 \times V_{ccSusHDA}$	V	1.5 mA	
VOH_HDA	Output High Voltage	$0.9 \times V_{ccSusHDA}$	—	V	-0.5 mA	
VOL_PWM (Server/Workstation Only)	Output Low Voltage	—	0.4	V	8 mA	
VOH_PWM (Server/Workstation Only)	Output High Voltage	—	—			1
VOL_SGPIO	Output Low Voltage	—	0.4	V		



Table 8-10. DC Output Characteristics (Sheet 2 of 2)

Symbol	Parameter	Min	Max	Unit	I _{OL} / I _{OH}	Notes
VOL_CRT	Output Low Voltage	—	0.5	V	8 mA	
VOH_CRT	Output High Voltage	2.4	—	V	8 mA	
VOL_CL1	Output Low Voltage	—	0.15	V	1 mA	
VOH_CL1	Output High Voltage	.61	.98	V		
VOL_SST (Server/ Workstation Only)	Output Low Voltage	0	0.3	V	0.5 mA	
VOH_SST (Server/ Workstation Only)	Output High Voltage	1.1	1.5	V	-6 mA	
VOL_PECI	Output Low Voltage	—	0.25 × V _{PROC_IO}	V	0.5 mA	
VOH_PECI	Output High Voltage	0.75 × V _{PROC_IO}	V _{PROC_IO}		-6 mA	
VOL_HDA	Output Low Voltage	—	0.1 × V _{ccHDA}	V	1.5 mA	
VOL_JTAG	Output Low Voltage	0	0.1 × 1.05 V	V	1.5 mA	
V_CLKOUT_swi ng	Differential Output Swing	300	—	mV		
V_CLKOUT_cro ss	Clock Cross-Over point	300	550	mV		
V_CLKOUTMIN	Min output Voltage	-0.3	—	V		
V_CLKOUTMAX	Max output Voltage		1.15 V	V		
VOL_PCICLK	Output Low Voltage	—	0.4	V	-1 mA	
VOH_PCICLK	Output High Voltage	2.4	—	V	1 mA	
VAUX-Diff-P-P	Digital Display Port Auxiliary Signal peak-to- peak voltage at transmitting device	0.39	1.38	V _{diffp} -p		
VOL_FDI	Output Low Voltage	-.1	0.2 × 3.3 V	V	4.1 mA	7
VOH_FDI	Output High Voltage	0.8 × 3.3 V	1.2	V	4.1 mA	7
V _{OMIN10} - Gen3i	Minimum Output Voltage	200	—	mV _{dif} fp-p		3
V _{OMAX10} - Gen3i	Maximum Output Voltage	—	900	mV _{dif} fp-p		3
V _{OMIN11} - PCIeGen12	Output Low Voltage	800	—	mV _{dif} fp-p		2
V _{OMAX11} - PCIeGen12	Output High Voltage	—	1200	mV _{dif} fp-p		2

NOTES:

1. The SERR#, PIRQ[H:A], SMBDATA, SMBCLK, SML[1:0]CLK, SML[1:0]DATA, SML[1:0]ALERT# and PWM[3:0] signals has an open-drain driver and SATALED# has an open-collector driver, and the V_{OH} specification does not apply. This signal must have external pull-up resistor.
2. PCI Express mV_{dif} p-p = 2*|PETp[x] - PETn[x]|
3. SATA V_{dif}, tx (V_{OMIN7}/V_{OMAX7}) is measured at the SATA connector on the transmit side (generally, the motherboard connector), where SATA mV_{dif} p-p = 2*|SATA[x]TXP - SATA[x]TXN|



4. Maximum I_{ol} for PROCPWRGD is 12mA for short durations (<500 mS per 1.5 s) and 9 mA for long durations.
5. For INIT3_3V only, for low current devices, the following applies: V_{OL5} Max is 0.15 V at an I_{OL5} of 2 mA.
6. 3.3 V refers to VccSus3_3 for signals in the suspend well, to Vcc3_3 for signals in the core well, to VccDSW3_3 for those signals in the Deep S4/S5 well. See Table 3-2 or Table 3-3 for signal and power well association.
7. 3.3 V refers to VccSus3_3 for signals in the suspend well, to Vcc3_3 for signals in the core well, VccDSW3_3 for signals in the Deep S4/S5 well. See Table 3-2, or Table 3-3 for signal and power well association.

Table 8-11. Other DC Characteristics (Sheet 1 of 2)

Symbol	Parameter	Min	Nom	Max	Unit	Notes
V_PROC_IO	Processor I/F	.95	1.0	1.05	V	1
V_PROC_IO	Processor I/F	.998	1.05	1.10	V	1
V5REF	PCH Core Well Reference Voltage	4.75	5	5.25	V	1
Vcc3_3	I/O Buffer Voltage	3.14	3.3	3.47	V	1
VccVRM	Internal PLL and VRMs (1.5V for Mobile)	1.455	1.5	1.545	V	1, 3
VccVRM	1.8 V Internal PLL and VRMs (1.8 V for Desktop)	1.746	1.8	1.854	V	1, 3
V5REF_Sus	Suspend Well Reference Voltage	4.75	5	5.25	V	1
VccSus3_3	Suspend Well I/O Buffer Voltage	3.14	3.3	3.47	V	1
VccCore	Internal Logic Voltage	.998	1.05	1.10	V	1
VccIO	Core Well I/O buffers	.998	1.05	1.10	V	1
VccDMI	DMI Buffer Voltage	.95	1.0	1.05	V	1
VccDMI	DMI Buffer Voltage	.998	1.05	1.10	V	1
VccClkDMI	DMI Clock Buffer Voltage	.998	1.05	1.10		1
VccSPI	3.3 V Supply for SPI Controller Logic	3.14	3.3	3.47	V	1
VccASW	1.05 V Supply for Intel® Management Engine and Integrated LAN	.998	1.05	1.10	V	1
VccRTC (G3-S0)	Battery Voltage	2	—	3.47	V	1
VccSusHDA	High Definition Audio Controller Suspend Voltage	3.14	3.3	3.47	V	1
VccSusHDA (low voltage)	High Definition Audio Controller Low Voltage Mode Suspend Voltage	1.43	1.5	1.58	V	1
VccADPLLA	Display PLL A power	.998	1.05	1.10		1
VccADPLLB	Display PLL B power	.998	1.05	1.10		1
VccADAC	Display DAC Analog Power. This power is supplied by the core well.	3.14	3.3	3.47		1
VccALVDS	Analog power supply for LVDS (Mobile Only)	3.14	3.3	3.47		1
VccTX_LVDS	I/O power supply for LVDS. (Mobile Only)	1.71	1.8	1.89		
VccSSC	Spread Modulators Power Supply	.998	1.05	1.10	V	1
VccDIFFCLKN	Differential Clock Buffers Power Supply	.998	1.05	1.10	V	1
VccDFTERM	1.8V power supply for DF_TV5	1.71	1.8	1.89	V	1
VccACLK	Analog Power Supply for internal PLL	.998	1.05	1.10	V	1

Table 8-11. Other DC Characteristics (Sheet 2 of 2)

Symbol	Parameter	Min	Nom	Max	Unit	Notes
VccAPLLEXP	Analog Power Supply for DMI PLL	.998	1.05	1.10	V	1
VccFDIPLL	Analog Power Supply for FDI PLL	.998	1.05	1.10	V	1
VccDSW3_3	3.3 V supply for Deep S4/S5 wells	3.14	3.3	3.47		1
I _{LI1}	PCI_3V Hi-Z State Data Line Leakage	-10	—	10	μA	(0 V < V _{IN} < V _{cc3_3})
I _{LI2}	PCI_5V Hi-Z State Data Line Leakage	-70	—	70	μA	Max V _{IN} = 2.7 V Min V _{IN} = 0.5 V
I _{LI3}	Input Leakage Current – All Other	-10	—	10	μA	2
C _{IN}	Input Capacitance – All Other	—	—	TBD	pF	F _C = 1 MHz
C _{OUT}	Output Capacitance	—	—	TBD	pF	F _C = 1 MHz
C _{I/O}	I/O Capacitance	—	—	10	pF	F _C = 1 MHz
		Typical Value				
C _L	XTAL25_IN	3			pF	
C _L	RTCX1	6			pF	

NOTES:

- The I/O buffer supply voltage is measured at the PCH package pins. The tolerances shown in Table 8-11 are inclusive of all noise from DC up to 20 MHz. In testing, the voltage rails should be measured with a bandwidth limited oscilloscope that has a rolloff of 3 dB/decade above 20 MHz.
- Includes Single Ended clocks REFCLK14IN, CLKOUTFLEX[3:0] and PCICLKIN.
- Includes only DC tolerance. AC tolerance will be 2% in addition to this range.

8.5 Display DC Characteristics

Table 8-12. Signal Groups

Signal Group	Associated Signals	Note
LVDS	LVDSA_DATA[3:0], LVDSA_DATA#[3:0], LVDSA_CLK, LVDSA_CLK#, LVDSB_DATA[3:0], LVDSB_DATA#[3:0], LVDSB_CLK, LVDSB_CLK#	
CRT DAC	CRT_RED, CRT_GREEN, CRT_BLUE, CRT_IRTN, CRT_TVO_IREF	
Digital DisplayPort Auxilliary	DDP[D:B]_AUX[P,N]	

Table 8-13. CRT DAC Signal Group DC Characteristics: Functional Operating Range (VccADAC = 3.3 V ±5%) (Sheet 1 of 2)

Parameter	Min	Nom	Max	Unit	Notes
DAC Resolution	—	8	—	Bits	1
Max Luminance (full-scale)	0.665	0.7	0.77	V	1, 2, 4 white video level voltage
Min Luminance	—	0	—	V	1, 3, 4 black video level voltage
LSB Current	—	73.2	—	μA	4, 5
Integral Linearity (INL)	-1	—	1	LSB	1, 6

Table 8-13. CRT DAC Signal Group DC Characteristics: Functional Operating Range (V_{CCADAC} = 3.3 V ±5%) (Sheet 2 of 2)

Parameter	Min	Nom	Max	Unit	Notes
Differential Linearity (DNL)	-1	—	1	LSB	1, 6
Video channel-channel voltage amplitude mismatch	—	—	6	%	7
Monotonicity	Yes				

NOTES:

1. Measured at each R, G, B termination according to the VESA Test Procedure – Evaluation of Analog Display Graphics Subsystems Proposal (Version 1, Draft 4, December 1, 2000).
2. Max steady-state amplitude
3. Min steady-state amplitude
4. Defined for a double 75-Ω termination.
5. Set by external reference resistor value.
6. INL and DNL measured and calculated according to VESA video signal standards.
7. Max full-scale voltage difference among R,G,B outputs (percentage of steady-state full-scale voltage).

Table 8-14. LVDS Interface: Functional Operating Range (V_{CCALVDS} = 1.8 V ±5%)

Symbol	Parameter	Min	Nom	Max	Unit
VOD	Differential Output Voltage	250	350	450	mV
ΔVOD	Change in VOD between Complementary Output States	—	—	50	mV
VOS	Offset Voltage	1.125	1.25	1.375	V
ΔVOS	Change in VOS between Complementary Output States	—	—	50	mV
IOs	Output Short Circuit Current	—	-3.5	-10	mA
IOZ	Output TRI-STATE Current	—	±1	±10	μA
V _{cm(ac)}	AC Common Mode noise			150	mV

Table 8-15. Display Port Auxiliary Signal Group DC Characteristics

Symbol	Parameter	Min	Nom	Max	Unit
V _{aux-diff-p-p}	Aux peak-to-peak voltage at a transmitting devices	0.39	—	1.38	V
	Aux peak-to-peak voltage at a receiving devices	0.32	—	1.36	V
V _{aux-term-R}	AUX CH termination DC resistance	—	100	—	Ω
V _{-aux-dc-cm}	AUX DC common mode voltage	0	—	2	V
V _{-aux_turn-CM}	Aux turn around common mode voltage	—	0.4	V	



8.6 AC Characteristics

Table 8-16. PCI Express* Interface Timings

Symbol	Parameter	Min	Max	Unit	Figures	Notes
Transmitter and Receiver Timings						
UI	Unit Interval – PCI Express* Gen 1 (2.5 GT/s)	399.88	400.12	ps		5
UI	Unit Interval – PCI Express* Gen 2 (5.0 GT/s)	199.9	200.1	ps		5
T _{TX-EYE}	Minimum Transmission Eye Width	0.7	—	UI	8-28	1,2
T _{TX-RISE/Fall (Gen1)}	D+/D- TX Out put Rise/Fall time	–0.125		UI		1,2
T _{TX-RISE/Fall (Gen2)}	D+/D- TX Out put Rise/Fall time	–0.15		UI		1,2
T _{RX-EYE}	Minimum Receiver Eye Width	0.40	—	UI	8-29	3,4

NOTES:

- Specified at the measurement point into a timing and voltage compliance test load and measured over any 250 consecutive TX UIs. (Also refer to the Transmitter compliance eye diagram)
- A T_{TX-EYE} = 0.70 UI provides for a total sum of deterministic and random jitter budget of T_{TXJITTER-MAX} = 0.30 UI for the Transmitter collected over any 250 consecutive TX UIs. The T_{TXEYE-MEDIAN-to-MAX-JITTER} specification ensures a jitter distribution in which the median and the maximum deviation from the median is less than half of the total TX jitter budget collected over any 250 consecutive TX UIs. It should be noted that the median is not the same as the mean. The jitter median describes the point in time where the number of jitter points on either side is approximately equal as opposed to the averaged time value.
- Specified at the measurement point and measured over any 250 consecutive UIs. The test load documented in the PCI Express* specification 2.0 should be used as the RX device when taking measurements (also refer to the Receiver compliance eye diagram). If the clocks to the RX and TX are not derived from the same reference clock, the TX UI recovered from 3500 consecutive UI must be used as a reference for the eye diagram.
- A T_{RX-EYE} = 0.40 UI provides for a total sum of 0.60 UI deterministic and random jitter budget for the Transmitter and interconnect collected any 250 consecutive UIs. The T_{RX-EYE-MEDIAN-to-MAX-JITTER} specification ensures a jitter distribution in which the median and the maximum deviation from the median is less than half of the total 0.6 UI jitter budget collected over any 250 consecutive TX UIs. It should be noted that the median is not the same as the mean. The jitter median describes the point in time where the number of jitter points on either side is approximately equal as opposed to the averaged time value. If the clocks to the RX and TX are not derived from the same reference clock, the TX UI recovered from 3500 consecutive UI must be used as the reference for the eye diagram.
- Nominal Unit Interval is 400 ps for 2.5 GT/s and 200 ps for 5 GT/s.

**Table 8-17. HDMI Interface Timings (DDP[D:B][3:0])Timings**

Symbol	Parameter	Min	Max	Unit	Figures	Notes
Transmitter and Receiver Timings						
UI	Unit Interval	600	4000	ps		
T _{TX-EYE}	Minimum Transmission Eye Width	0.8	—	UI		1,2
T _{TX-RISE/Fall}	D+/D- TX Out put Rise/Fall time	—	0.125	UI		1,2
TMDS Clock Jitter		—	0.25	UI		
T-skew-intra-pair	Intra pair skew at source connector	—	0.15	T _{BIT}		
T-skew-inter-pair	Inter pair skew at source connector	—	0.2	Tcharacter		
Duty Cycle	Clock Duty Cycle	10	60%	%		

NOTES:

- Specified at the measurement point into a timing and voltage compliance test load and measured over any 250 consecutive TX UIs. (Also refer to the Transmitter compliance eye diagram)
- A T_{TX-EYE} = 0.70 UI provides for a total sum of deterministic and random jitter budget of T_{TXJITTER-MAX} = 0.30 UI for the Transmitter collected over any 250 consecutive TX UIs. The T_{TXEYE-MEDIAN-to-MAX-JITTER} specification ensures a jitter distribution in which the median and the maximum deviation from the median is less than half of the total TX jitter budget collected over any 250 consecutive TX UIs. It should be noted that the median is not the same as the mean. The jitter median describes the point in time where the number of jitter points on either side is approximately equal as opposed to the averaged time value.

Table 8-18. SDVO Interface Timings

Symbol	Parameter	Min	Max	Unit	Figures	Notes
Transmitter and Receiver Timings						
UI	Unit Interval	369.89	1000	ps		5
T _{TX-EYE}	Minimum Transmission Eye Width	0.7	—	UI	8-28	1,2
T _{TX-RISE/Fall}	D+/D- TX Out put Rise/Fall time	—	0.125	UI		1,2
T _{RX-EYE}	Minimum Receiver Eye Width	0.40	—	UI	8-29	3,4

NOTES:

- Specified at the measurement point into a timing and voltage compliance test load and measured over any 250 consecutive TX UIs. (Also refer to the Transmitter compliance eye diagram)
- A T_{TX-EYE} = 0.70 UI provides for a total sum of deterministic and random jitter budget of T_{TXJITTER-MAX} = 0.30 UI for the Transmitter collected over any 250 consecutive TX UIs. The T_{TXEYE-MEDIAN-to-MAX-JITTER} specification ensures a jitter distribution in which the median and the maximum deviation from the median is less than half of the total TX jitter budget collected over any 250 consecutive TX UIs. It should be noted that the median is not the same as the mean. The jitter median describes the point in time where the number of jitter points on either side is approximately equal as opposed to the averaged time value.

3. Specified at the measurement point and measured over any 250 consecutive UIs. The test load documented in the PCI Express* specification 2.0 should be used as the RX device when taking measurements (also refer to the Receiver compliance eye diagram). If the clocks to the RX and TX are not derived from the same reference clock, the TX UI recovered from 3500 consecutive UI must be used as a reference for the eye diagram.
4. A $T_{RX-EYE} = 0.40$ UI provides for a total sum of 0.60 UI deterministic and random jitter budget for the Transmitter and interconnect collected any 250 consecutive UIs. The $T_{RX-EYE-MEDIAN-to-MAX-JITTER}$ specification ensures a jitter distribution in which the median and the maximum deviation from the median is less than half of the total 0.6 UI jitter budget collected over any 250 consecutive TX UIs. It should be noted that the median is not the same as the mean. The jitter median describes the point in time where the number of jitter points on either side is approximately equal as opposed to the averaged time value. If the clocks to the RX and TX are not derived from the same reference clock, the TX UI recovered from 3500 consecutive UI must be used as the reference for the eye diagram.
5. Nominal Unit Interval for highest SDVO speed is 370 ps. However, depending on the resolution on the interface, the UI may be more than 370 ps.

Table 8-19. DisplayPort Interface Timings (DDP[D:B][3:0])

Symbol P	Parameter	Min	Nom	Max	Unit
UI_High_Rate	Unit Interval for High Bit Rate (2.7 Gbps/lane)	370	—	ps	
UI_Low_Rate	Unit Interval for Reduced Bit Rate (1.62 Gbps/lane)	617	—	ps	
Down_Spread_Amplitude	Link clock down spreading	0	—	0.5	%
Down_Spread_Frequency	Link clock down-spreading frequency	30	—	33	kHz
Ltx-skew-intrapair	Lane Intra-pair output skew at Tx package pins	—	20	ps	
Ttx-rise/fall_mismatch_chipdiff	Lane Intra-pair Rise/Fall time mismatch at Tx package pin	5	%	—	
V _{TX-DIFFp-p-level1}	Differential Peak-to-peak Output Voltage level 1	0.34	0.4	0.46	V
V _{TX-DIFFp-p-level2}	Differential Peak-to-peak Output Voltage level 2	0.51	0.6	0.68	V
V _{TX-DIFFp-p-level3}	Differential Peak-to-peak Output Voltage level 3	0.69	0.8	0.92	V
V _{TX-preemp_ratio}	No Pre-emphasis	0	0	0	dB
V _{TX-preemp_ratio}	3.5 dB Pre-emphasis Level	2.8	3.5	4.2	dB
V _{TX-preemp_ratio}	6.0 dB Pre-emphasis Level	4.8	6	7.2	dB
L _{TX-SKEW-INTER_PAIR}	Lane-to-Lane Output Skew at Tx package pins	—	—	2	UI

**Table 8-20. DisplayPort Aux Interface**

Symbol	Parameter	Min	Nom	Max	Unit
UI	Aux unit interval	0.4	0.5	0.6	μs
T-Aux_bus_park	AUX CH bus park time	10	—	—	ns
Tcycle-to-cycle jitter	maximum allowable UI variation within a single transaction at the connector pins of a transmitting device	0.04	UI	—	
	maximum allowable UI variation within a single transaction at the connector pins of a receiving device	0.05	UI	—	

Table 8-21. DDC Characteristics

DDC Signals: CRT_DDC_CLK, CRT_DDC_DATA, L_DDC_CLK, L_DDC_DATA, SDVO_CTRLCLK, SDVO_CTRLDATA, DDP[D:C]_CTRLCLK, DDP[D:C]_CTRLDATA

Symbol	Parameter	Standard Mode	Fast Mode		1 MHz		Units
		Max	Min	Max	Min	Max	
F _{scl}	Operating Frequency	100	—	400	—	1000	kHz
T _r	Rise Time ¹	—	—	—	—	—	ns
T _f	Fall Time ¹	250	20+0.1Cb ²	250	—	120	ns

NOTE:

1. Measurement Point for Rise and Fall time: V_{IL(min)}–V_{IL(max)}
2. Cb = total capacitance of one bus line in pF. If mixed with High-speed mode devices, faster fall times according to High-Speed mode T_r/T_f are allowed.

Table 8-22. LVDS Interface AC Characteristics at Various Frequencies (Sheet 1 of 2)

Symbol	Parameter	Min	Nom	Max	Unit	Figures	Notes
LLHT	LVDS Low-to-High Transition Time	0.25	0.5	0.75	ns	8-26	1, Across receiver termination
LHLT	LVDS High-to-Low Transition Time	0.25	0.5	0.75	ns		1, Across receiver termination
Frequency = 40-MHz							
TPPos0	Transmitter Output Pulse for Bit 0	-0.25	0	0.25	ns	8-27	
TPPos1	Transmitter Output Pulse for Bit 1	3.32	3.57	3.82	ns		
TPPos2	Transmitter Output Pulse for Bit 2	6.89	7.14	7.39	ns		
TPPos3	Transmitter Output Pulse for Bit 3	10.46	10.71	10.96	ns		
TPPos4	Transmitter Output Pulse for Bit 4	14.04	14.29	14.54	ns		
TPPos5	Transmitter Output Pulse for Bit 5	17.61	17.86	18.11	ns		
TPPos6	Transmitter Output Pulse for Bit 6	21.18	21.43	21.68	ns		
TJCC	Transmitter Jitter Cycle-to-Cycle	—	350	370	ps		
Frequency = 65-MHz							
TPPos0	Transmitter Output Pulse for Bit 0	-0.20	0	0.20	ns	8-27	
TPPos1	Transmitter Output Pulse for Bit 1	2.00	2.20	2.40	ns		
TPPos2	Transmitter Output Pulse for Bit 2	4.20	4.40	4.60	ns		
TPPos3	Transmitter Output Pulse for Bit 3	6.39	6.59	6.79	ns		
TPPos4	Transmitter Output Pulse for Bit 4	8.59	8.79	8.99	ns		
TPPos5	Transmitter Output Pulse for Bit 5	10.79	10.99	11.19	ns		
TPPos6	Transmitter Output Pulse for Bit 6	12.99	13.19	13.39	ns		
TJCC	Transmitter Jitter Cycle-to-Cycle	—	—	250	ps		

**Table 8-22. LVDS Interface AC Characteristics at Various Frequencies (Sheet 2 of 2)**

Symbol	Parameter	Min	Nom	Max	Unit	Figures	Notes
Frequency = 85-MHz							
TPPos0	Transmitter Output Pulse for Bit 0	-0.20	0	0.20	ns	8-27	
TPPos1	Transmitter Output Pulse for Bit 1	1.48	1.68	1.88	ns		
TPPos2	Transmitter Output Pulse for Bit 2	3.16	3.36	3.56	ns		
TPPos3	Transmitter Output Pulse for Bit 3	4.84	5.04	5.24	ns		
TPPos4	Transmitter Output Pulse for Bit 4	6.52	6.72	6.92	ns		
TPPos5	Transmitter Output Pulse for Bit 5	8.20	8.40	8.60	ns		
TPPos6	Transmitter Output Pulse for Bit 6	9.88	10.08	10.28	ns		
TJCC	Transmitter Jitter Cycle-to-Cycle	—	—	250	ps		
Frequency = 108-MHz							
TPPos0	Transmitter Output Pulse for Bit 0	-0.20	0	0.20	ns	8-27	
TPPos1	Transmitter Output Pulse for Bit 1	1.12	1.32	1.52	ns		
TPPos2	Transmitter Output Pulse for Bit 2	2.46	2.66	2.86	ns		
TPPos3	Transmitter Output Pulse for Bit 3	3.76	3.96	4.16	ns		
TPPos4	Transmitter Output Pulse for Bit 4	5.09	5.29	5.49	ns		
TPPos5	Transmitter Output Pulse for Bit 5	6.41	6.61	6.81	ns		
TPPos6	Transmitter Output Pulse for Bit 6	7.74	7.94	8.14	ns		
TJCC	Transmitter Jitter Cycle-to-Cycle	—	—	250	ps		

Table 8-23. CRT DAC AC Characteristics

Parameter	Min	Nom	Max	Units	Notes
Pixel Clock Frequency	400			MHz	
R, G, B Video Rise Time	0.25	—	1.25	ns	1, 2, 8 (10-90% of black-to-white transition, @ 400-MHz pixel clock)
R, G, B Video Fall Time	0.25	—	1.25	ns	1, 3, 8 (90-10% of white-to-black transition, @ 400-MHz pixel clock)
Settling Time	0.75			ns	1, 4, 8 @ 400-MHz pixel clock
Video channel-to-channel output skew	0.625			ns	1, 5, 8 @ 400-MHz pixel clock
Overshoot/Undershoot	-0.084	—	+0.084	V	1, 6, 8 Full-scale voltage step of 0.7 V
Noise Injection Ratio	2.5			%	1, 7, 8

NOTES:

- Measured at each R, G, B termination according to the VESA Test Procedure – Evaluation of Analog Display Graphics Subsystems Proposal (Version 1, Draft 4, December 1, 2000).
- R, G, B Max Video Rise/Fall Time: 50% of minimum pixel clock period.
- R, G, B Min Video Rise/Fall Time: 10% of minimum pixel clock period.
- Max settling time: 30% of minimum pixel clock period.
- Video channel-channel output skew: 25% of minimum pixel clock period.
- Overshoot/undershoot: $\pm 12\%$ of black-white video level (full-scale) step function.
- Noise injection ratio: 2.5% of maximum luminance voltage (dc to max. pixel frequency).
- R, G, B AC parameters are strongly dependent on the board implementation

Table 8-24. Clock Timings (Sheet 1 of 4)

Sym	Parameter	Min	Max	Unit	Notes	Figure
PCI Clock (CLKOUT_PCI[4:0])						
t1	Period	29.566	30.584	ns		8-11
t2	High Time	10.826	17.850	ns		8-11
t3	Low Time	10.426	17.651	ns		8-11
	Duty Cycle	40	60	%		
t4	Rising Edge Rate	1.0	4	V/ns		8-11
t5	Falling Edge Rate	1.0	4	V/ns		8-11
	Jitter	—	500	ps	8,9	
14.318 MHz Flex Clock						
t6	Period	68.83	70.84	ns		8-11
t7	High Time	29.55	39.00	ns		8-11
t8	Low Time	29.16	38.80	ns		8-11
	Duty Cycle	40	60	%		
-	Rising Edge Rate	1.0	4	V/ns	5	
-	Falling Edge Rate	1.0	4	V/ns	5	
	Jitter (14.318 MHz configured on CLKOUTFLEX1 or CLKOUTFLEX3)	—	800	ps	8,9	



Table 8-24. Clock Timings (Sheet 2 of 4)

Sym	Parameter	Min	Max	Unit	Notes	Figure
	Jitter(14.318 MHz configured on CLKOUTFLEX0 or CLKOUTFLEX2)	—	1000	ps	8,9	
48 MHz Flex Clock						
t9	Period	20.32	21.34	ns		8-11
t10	High Time	7.02	12.51	ns		8-11
t11	Low Time	6.63	12.30	ns		8-11
	Duty Cycle	40	60	%		
-	Rising Edge Rate	1.0	4	V/ns	5	
-	Falling Edge Rate	1.0	4	V/ns	5	
	Jitter (48MHz configured on CLKOUTFLEX1 or CLKOUTFLEX3)	—	410	ps	8,9	
	Jitter(48MHz configured on CLKOUTFLEX0 or CLKOUTFLEX2)	—	510	ps	8,9	
24 MHz Flex Clock						
t12	Period	41.16	42.18	ns		8-11
t13	High Time	22.64	23.19	ns		8-11
t14	Low Time	18.52	18.98	ns		8-11
	Duty Cycle	45	55	%		
-	Rising Edge Rate	1.0	4	V/ns	5	
-	Falling Edge Rate	1.0	4	V/ns	5	
	Jitter (24MHz configured on CLKOUTFLEX1 or CLKOUTFLEX3)	—	330	ps	8,9	
	Jitter(24MHz configured on CLKOUTFLEX0 or CLKOUTFLEX2)	—	510	ps	8,9	
27 MHz Flex Clock						
t15	Period	36.4	37.67	ns		8-11
t16	High Time	20.02	20.72	ns		8-11
t17	Low Time	16.38	16.95	ns		8-11
	Duty Cycle	45	55	%		
-	Rising Edge Rate	1.0	4	V/ns	5	
-	Falling Edge Rate	1.0	4	V/ns	5	
	Jitter (27MHz configured on CLKOUTFLEX1 or CLKOUTFLEX3)	—	450	ps	8,9	
	Jitter (27MHz configured on CLKOUTFLEX0 or CLKOUTFLEX2)	—	630	ps	8,9	
CLKOUT_DP_[P,N]						
Period	Period SSC On	7.983	8.726	ns		8-30
Period	Period SSC Off	7.983	8.684	ns		8-30
DtyCyc	Duty Cycle	40	60	%		8-30
V _{swing}	Differential Output Swing	300	—	mV		8-30
Slew _{rise}	Rising Edge Rate	1.5	4	V/ns		8-30
Slew _{fall}	Falling Edge Rate	1.5	4	V/ns		8-30



Table 8-24. Clock Timings (Sheet 3 of 4)

Sym	Parameter	Min	Max	Unit	Notes	Figure	
	Jitter		350	ps	8,9		
CLKOUT_PCIE[7:0]_[P,N], CLKOUT_DMI_[P,N], CLKOUT_PEG_[B:A]_[P,N], CLKOUT_ITPXDPA_[P,N]							
Period	Period SSC On	9.849	10.201	ns		8-30	
Period	Period SSC Off	9.849	10.151	ns		8-30	
DtyCyc	Duty Cycle	40	60	%		8-30	
V_Swing	Differential Output Swing	300	—	mV		8-30	
Slew_rise	Rising Edge Rate	1.5	4	V/ns		8-30	
Slew_fall	Falling Edge Rate	1.5	4	V/ns		8-30	
	Jitter	—	150	ps	8,9,10		
SSC	Spread Spectrum	0	0.5	%	13,14		
SMBus/SMLink Clock (SMBCLK, SML[1:0]CLK)							
f _{smb}	Operating Frequency	10	100	KHz			
t ₂₂	High time	4.0	50	μs	2	8-20	
t ₂₃	Low time	4.7	—	μs		8-20	
t ₂₄	Rise time	—	1000	ns		8-20	
t ₂₅	Fall time	—	300	ns		8-20	
SMLink0 Clock (SML0CLK) (See note 15)							
f _{smb}	Operating Frequency	0	400	KHz			
t _{22_SML}	High time	0.6	50	μs	2	8-20	
t _{23_SML}	Low time	1.3	—	μs		8-20	
t _{24_SML}	Rise time	—	300	ns		8-20	
t _{25_SML}	Fall time	—	300	ns		8-20	
HDA_BCLK (Intel® High Definition Audio)							
f _{HDA}	Operating Frequency	24.0		MHz			
	Frequency Tolerance	—	100	ppm			
t _{26a}	Input Jitter (refer to Clock Chip Specification)	—	300	ppm			
t _{27a}	High Time (Measured at 0.75 Vcc)	18.75	22.91	ns		8-11	
t _{28a}	Low Time (Measured at 0.35 Vcc)	18.75	22.91	ns		8-11	
Suspend Clock (SUSCLK)							
f _{susclk}	Operating Frequency	32		kHz	4		
t ₃₉	High Time	10	—	μs	4		
t _{39a}	Low Time	10	—	μs	4		
XTAL25_IN/XTAL25_OUT							
ppm ¹²	CrystalTolerance cut accuracy max	35ppm(@ 25 °C +/- 3C)					
ppm ¹²	TempStability max	30ppm(10 °C to 70°C)					
ppm ¹²	Aging Max	5ppm					



Table 8-24. Clock Timings (Sheet 4 of 4)

Sym	Parameter	Min	Max	Unit	Notes	Figure
SPI_CLK						
Slew_Rise	Output Rise Slew Rate (0.2Vcc - 0.6Vcc)	1	4	V/ns	11	8-31
Slew_Fall	Output Fall Slew Rate (0.6Vcc - 0.2Vcc)	1	4	V/ns	11	8-31

NOTES:

- The CLK48 expects a 40/60% duty cycle.
- The maximum high time (t18 Max) provide a simple ensured method for devices to detect bus idle conditions.
- BCLK Rise and Fall times are measured from 10%VDD and 90%VDD.
- SUSCLK duty cycle can range from 30% minimum to 70% maximum.
- Edge rates in a system as measured from 0.8 V to 2.0 V.
- The active frequency can be 5 MHz, 50 MHz, or 62.5 MHz depending on the interface speed. Dynamic changes of the normal operating frequency are not allowed.
- Testing condition: 1 KOhm pull up to Vcc, 1 KOhm pull down and 10 pF pull down and 1/2 inch trace (see [Figure 8-31](#) for more detail).
- Jitter is specified as cycle to cycle as measured between two rising edges of the clock being characterized. Period min and max includes cycle to cycle jitter and is also measured between two rising edges of the clock being characterized.
- On all jitter measurements care should be taken to set the zero crossing voltage (for rising edge) of the clock to be the point where the edge rate is the fastest. Using a Math function = Average(Derivavitive(Ch1)) and set the averages to 64, place the cursors where the slope is the highest on the rising edge – usually this lower half of the rising edge. The reason this is defined is for users trying to measure in a system it is impossible to get the probe exactly at the end of the Transmission line with large Flip Chip components, this results in a reflection induced ledge in the middle of the rising edge and will significantly increase measured jitter.
- Phase jitter requirement: The designated Gen2 outputs will meet the reference clock jitter requirements from the *PCI Express Gen2 Base Specification*. The test is to be performed on a component test board under quiet conditions with all clock outputs on. Jitter analysis is performed using a standardized tool provided by the PCI SIG. Measurement methodology is defined in Intel document "PCI Express Reference Clock Jitter Measurements". Note that this is not for CLKOUT_PCIE[7:0].
- Testing condition: 1-kΩ pull-up to Vcc, 1 kΩ pull down and 10 pF pull-down and 1/2 inch trace (see [Figure 8-31](#) for more detail).
- Total of crystal cut accuracy, frequency variations due to temperature, parasitics, load capacitance variations and aging is recommended to be less than 90 ppm.
- Spread Spectrum (SSC) is referenced to rising edge of the clock.
- Spread Spectrum (SSC) of 0.25% on CLKOUT_PCIE[7:0] and CLKOUT_PEG_[B:A] is used for WiMAX friendly clocking purposes.
- When SMLink0 is configured to run in Fast Mode using a soft strap, the operating frequency is in the range of 300 kHz–400 kHz.

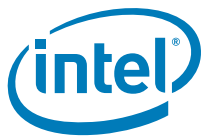

Table 8-25. PCI Interface Timing

Sym	Parameter	Min	Max	Units	Notes	Figure
t40	AD[31:0] Valid Delay	2	11	ns	1	8-12
t41	AD[31:0] Setup Time to PCICLK Rising	7	—	ns		8-13
t42	AD[31:0] Hold Time from PCICLK Rising	0	—	ns		8-13
t43	C/BE[3:0]#, FRAME#, TRDY#, IRDY#, STOP#, PAR, PERR#, PLOCK#, DEVSEL# Valid Delay from PCICLK Rising	2	11	ns	1	8-12
t44	C/BE[3:0]#, FRAME#, TRDY#, IRDY#, STOP#, PAR, PERR#, PLOCK#, IDSEL, DEVSEL# Output Enable Delay from PCICLK Rising	2		ns		8-16
t45	C/BE[3:0]#, FRAME#, TRDY#, IRDY#, STOP#, PERR#, PLOCK#, DEVSEL#, GNT[A:B]# Float Delay from PCICLK Rising	2	28	ns		8-14
t46	C/BE[3:0]#, FRAME#, TRDY#, IRDY#, STOP#, SERR#, PERR#, DEVSEL#, Setup Time to PCICLK Rising	7		ns		8-13
t47	C/BE[3:0]#, FRAME#, TRDY#, IRDY#, STOP#, SERR#, PERR#, DEVSEL#, REQ[A:B]# Hold Time from PCLKIN Rising	0	—	ns		8-13
t48	PCIRST# Low Pulse Width	1		ms		8-15
t49	GNT[3:0]# Valid Delay from PCICLK Rising	2	12	ns		
t50	REQ[3:0]# Setup Time to PCICLK Rising	12	—	ns		

NOTE:

1. Refer to note 3 of table 4-4 in Section 4.2.2.2 and note 2 of table 4-6 in Section 4.2.3.2 of the *PCI Local Bus Specification*, Revision 2.3 for measurement details.

**Table 8-26. Universal Serial Bus Timing**

Sym	Parameter	Min	Max	Units	Notes	Fig
Full-speed Source (Note 7)						
t100	USBPx+, USBPx- Driver Rise Time	4	20	ns	1, $C_L = 50$ pF	8-17
t101	USBPx+, USBPx- Driver Fall Time	4	20	ns	1, $C_L = 50$ pF	8-17
t102	Source Differential Driver Jitter - To Next Transition - For Paired Transitions	-3.5 -4	3.5 4	ns ns	2, 3	8-18
t103	Source SE0 interval of EOP	160	175	ns	4	8-19
t104	Source Jitter for Differential Transition to SE0 Transition	-2	5	ns	5	
t105	Receiver Data Jitter Tolerance - To Next Transition - For Paired Transitions	-18.5 -9	18.5 9	ns ns	3	8-18
t106	EOP Width: Must accept as EOP	82	—	ns	4	8-19
t107	Width of SE0 interval during differential transition	—	14	ns		
Low-speed Source (Note 8)						
t108	USBPx+, USBPx – Driver Rise Time	75	300	ns	1, 6 $C_L = 50$ pF $C_L = 350$ pF	8-17
t109	USBPx+, USBPx – Driver Fall Time	75	300	ns	1, 6 $C_L = 50$ pF $C_L = 350$ pF	8-17
t110	Source Differential Driver Jitter To Next Transition For Paired Transitions	-25 -14	25 14	ns ns	2, 3	8-18
t111	Source SE0 interval of EOP	1.25	1.50	μs	4	8-19
t112	Source Jitter for Differential Transition to SE0 Transition	-40	100	ns	5	
t113	Receiver Data Jitter Tolerance - To Next Transition - For Paired Transitions	-152 -200	152 200	ns ns	3	8-18
t114	EOP Width: Must accept as EOP	670	—	ns	4	8-19
t115	Width of SE0 interval during differential transition	—	210	ns		

NOTES:

1. Driver output resistance under steady state drive is specified at 28 Ω at minimum and 43 Ω at maximum.
2. Timing difference between the differential data signals.
3. Measured at crossover point of differential data signals.
4. Measured at 50% swing point of data signals.
5. Measured from last crossover point to 50% swing point of data line at leading edge of EOP.
6. Measured from 10% to 90% of the data signal.
7. Full-speed Data Rate has minimum of 11.97 Mb/s and maximum of 12.03 Mb/s.
8. Low-speed Data Rate has a minimum of 1.48 Mb/s and a maximum of 1.52 Mb/s.

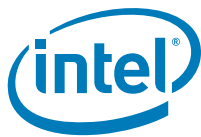

Table 8-27. SATA Interface Timings

Sym	Parameter	Min	Max	Units	Notes	Figure
UI	Gen I Operating Data Period	666.43	670.23	ps		
UI-2	Gen II Operating Data Period (3Gb/s)	333.21	335.11	ps		
UI-3	Gen III Operating Data Period (6Gb/s)	166.6083	166.6667	ps		
t120gen1	Rise Time	0.15	0.41	UI	1	
t120gen2	Rise Time	0.2	0.41	UI	1	
t120gen3	Rise Time	0.2	0.41	UI	1	
t121gen1	Fall Time	0.15	0.41	UI	2	
t121gen2	Fall Time	0.2	0.41	UI	2	
t121gen3	Fall Time	0.2	0.41	UI	2	
t122	TX differential skew	—	20	ps		
t123	COMRESET	310.4	329.6	ns	3	
t124	COMWAKE transmit spacing	103.5	109.9	ns	3	
t125	OOB Operating Data period	646.67	686.67	ns	4	

NOTES:

1. 20% – 80% at transmitter
2. 80% – 20% at transmitter
3. As measured from 100 mV differential crosspoints of last and first edges of burst.
4. Operating data period during Out-Of-Band burst transmissions.

**Table 8-28. SMBus and SMLink Timing**

Sym	Parameter	Min	Max	Units	Notes	Fig
t130	Bus Free Time Between Stop and Start Condition	4.7	—	μs		8-20
t130SMLFM	Bus Free Time Between Stop and Start Condition	1.3	—	μs	5	8-20
t131	Hold Time after (repeated) Start Condition. After this period, the first clock is generated.	4.0	—	μs		8-20
t131SMLFM	Hold Time after (repeated) Start Condition. After this period, the first clock is generated.	0.6	—	μs	5	8-20
t132	Repeated Start Condition Setup Time	4.7	—	μs		8-20
t132SMLFM	Repeated Start Condition Setup Time	0.6	—	μs	5	8-20
t133	Stop Condition Setup Time	4.0	—	μs		8-20
t133SMLFM	Stop Condition Setup Time	0.6	—	μs	5	8-20
t134	Data Hold Time	0	—	ns	4	8-20
t134SMLFM	Data Hold Time	0	—	ns	4, 5	8-20
t135	Data Setup Time	250	—	ns		8-20
t135SMLFM	Data Setup Time	100	—	ns	5	8-20
t136	Device Time Out	25	35	ms	1	
t137	Cumulative Clock Low Extend Time (slave device)	—	25	ms	2	8-21
t138	Cumulative Clock Low Extend Time (master device)	—	10	ms	3	8-21

NOTES:

1. A device will timeout when any clock low exceeds this value.
2. t137 is the cumulative time a slave device is allowed to extend the clock cycles in one message from the initial start to stop. If a slave device exceeds this time, it is expected to release both its clock and data lines and reset itself.
3. t138 is the cumulative time a master device is allowed to extend its clock cycles within each byte of a message as defined from start-to-ack, ack-to-ack or ack-to-stop.
4. t134 has a minimum timing for I²C of 0 ns, while the minimum timing for SMBus/SMLINK is 300 ns.
5. Timings with the SMLFM designator apply only to SMLink0 and only when SMLink0 is operating in Fast Mode.

Table 8-29. Intel® High Definition Audio Timing

Sym	Parameter	Min	Max	Units	Notes	Fig
t143	Time duration for which HDA_SD is valid before HDA_BCLK edge.	7	—	ns		8-23
t144	Time duration for which HDA_SDO is valid after HDA_BCLK edge.	7	—	ns		8-23
t145	Setup time for HDA_SDIN[3:0] at rising edge of HDA_BCLK	15	—	ns		8-23
t146	Hold time for HDA_SDIN[3:0] at rising edge of HDA_BCLK	0	—	ns		8-23

Table 8-30. LPC Timing

Sym	Parameter	Min	Max	Units	Notes	Fig
t150	LAD[3:0] Valid Delay from PCICLK Rising	2	11	ns		8-12
t151	LAD[3:0] Output Enable Delay from PCICLK Rising	2	—	ns		8-16
t152	LAD[3:0] Float Delay from PCICLK Rising	—	28	ns		8-14
t153	LAD[3:0] Setup Time to PCICLK Rising	7	—	ns		8-13
t154	LAD[3:0] Hold Time from PCICLK Rising	0	—	ns		8-13
t155	LDRQ[1:0]# Setup Time to PCICLK Rising	12	—	ns		8-13
t156	LDRQ[1:0]# Hold Time from PCICLK Rising	0	—	ns		8-13
t157	eE# Valid Delay from PCICLK Rising	2	12	ns		8-12

Table 8-31. Miscellaneous Timings

Sym	Parameter	Min	Max	Units	Notes	Fig
t160	SERIRQ Setup Time to PCICLK Rising	7	—	ns		8-13
t161	SERIRQ Hold Time from PCICLK Rising	0	—	ns		8-13
t162	RI#, GPIO, USB Resume Pulse Width	2	—	RTCCCLK		8-15
t163	SPKR Valid Delay from OSC Rising	—	200	ns		8-12
t164	SERR# Active to NMI Active	—	200	ns		

**Table 8-32. SPI Timings (20 MHz)**

Sym	Parameter	Min	Max	Units	Notes	Fig
t180a	Serial Clock Frequency - 20M Hz Operation	17.06	18.73	MHz	1	
t183a	Tco of SPI_MOSI with respect to serial clock falling edge at the host	-5	13	ns		8-22
t184a	Setup of SPI_MISO with respect to serial clock falling edge at the host	16	—	ns		8-22
t185a	Hold of SPI_MISO with respect to serial clock falling edge at the host	0	—	ns		8-22
t186a	Setup of SPI_CS[1:0]# assertion with respect to serial clock rising at the host	30	—	ns		8-22
t187a	Hold of SPI_CS[1:0]# deassertion with respect to serial clock falling at the host	30	—	ns		8-22
t188a	SPI_CLK high time	26.37	—	ns		8-22
t189a	SPI_CLK low time	26.82	—	ns		8-22

NOTES:

1. The typical clock frequency driven by the PCH is 17.86 MHz.
2. Measurement point for low time and high time is taken at 0.5(VccSPI)

Table 8-33. SPI Timings (33 MHz)

Sym	Parameter	Min	Max	Units	Notes	Fig
t180b	Serial Clock Frequency - 33 MHz Operation	29.83	32.81	MHz	1	
t183b	Tco of SPI_MOSI with respect to serial clock falling edge at the host	-5	5	ns		8-22
t184b	Setup of SPI_MISO with respect to serial clock falling edge at the host	8	—	ns		8-22
t185b	Hold of SPI_MISO with respect to serial clock falling edge at the host	0	—	ns		8-22
t186b	Setup of SPI_CS[1:0]# assertion with respect to serial clock rising at the host	30	—	ns		8-22
t187b	Hold of SPI_CS[1:0]# deassertion with respect to serial clock falling at the host	30	—	ns		8-22
t188b	SPI_CLK High time	14.88	-	ns		8-22
t189b	SPI_CLK Low time	15.18	-	ns		8-22

NOTE:

1. The typical clock frequency driven by the PCH is 31.25 MHz.
2. Measurement point for low time and high time is taken at 0.5(VccSPI).

Table 8-34. SPI Timings (50 MHz)

Sym	Parameter	Min	Max	Units	Notes	Fig
t180c	Serial Clock Frequency - 50-MHz Operation	46.99	53.40	MHz	1	
t183c	Tco of SPI_MOSI with respect to serial clock falling edge at the host	-3	3	ns		8-22
t184c	Setup of SPI_MISO with respect to serial clock falling edge at the host	8	—	ns		8-22
t185c	Hold of SPI_MISO with respect to serial clock falling edge at the host	0	—	ns		8-22
t186c	Setup of SPI_CS[1:0]# assertion with respect to serial clock rising edge at the host	30	—	ns		8-22
t187c	Hold of SPI_CS[1:0]# assertion with respect to serial clock rising edge at the host	30	—	ns		8-22
t188c	SPI_CLK High time	7.1	—	ns	2, 3	8-22
t189c	SPI_CLK Low time	11.17	—	ns	2, 3	8-22

NOTE:

- Typical clock frequency driven by the PCH is 50 MHz.
- When using 50 MHz mode ensure target flash component can meet t188c and t189c specifications. Measurement should be taken at a point as close as possible to the package pin.
- Measurement point for low time and high time is taken at 0.5(VccSPI).

Table 8-35. SST Timings (Server/Workstation Only)

Sym	Parameter	Min	Max	Units	Notes	Fig
t _{BIT}	Bit time (overall time evident on SST)	0.495	500	μs	1	-
	Bit time driven by an originator	0.495	250	μs		
t _{BIT,jitter}	Bit time jitter between adjacent bits in an SST message header or data bytes after timing has been negotiated	—	—	%		
t _{BIT,drift}	Change in bit time across a SST address or SST message bits as driven by the originator. This limit only applies across t _{BIT-A} bit drift and t _{BIT-M} drift.	—	—	%		
t _{H1}	High level time for logic '1'	0.6	0.8	x t _{BIT}	2	
t _{H0}	High level time for logic '0'	0.2	0.4	x t _{BIT}		
t _{SSTR}	Rise time (measured from V _{OL} = 0.3V to V _{IH,min})	—	25 + 5	ns/ node		
t _{SSTF}	Fall time (measured from V _{OH} = 1.1V to V _{IL,max})	—	33	ns/ node		

NOTES:

- The originator must drive a more restrictive time to allow for quantized sampling errors by a client yet still attain the minimum time less than 500 μs. t_{BIT} limits apply equally to t_{BIT-A} and t_{BIT-M}. PCH is targeted on 1 Mbps which is 1 μs bit time.
- The minimum and maximum bit times are relative to t_{BIT} defined in the Timing Negotiation pulse.
- t_{BIT-A} is the negotiated address bit time and t_{BIT-M} is the negotiated message bit time.

**Table 8-36. Controller Link Receive Timings**

Sym	Parameter	Min	Max	Units	Notes	Fig
t190	Single bit time	13	—	ns		8-32
t191	Single clock period	15	—	ns		8-32
t192	Rise time/Fall time	0.11	3.5	V/ns	1	8-33
t193	Setup time before CL_CLK1	0.9	—	ns		8-32
t194	Hold time after CL_CLK1	0.9	—	ns		8-32
V _{IL_AC}	Input low voltage (AC)		CL_Vref - 0.08	V	2	
V _{IH_AC}	Input high voltage (AC)	CL_Vref + 0.08		V	2	

NOTES:

1. Measured from (CL_Vref – 50 mV to CL_Vref + 50 mV) at the receiving device side. No test load is required for this measurement as the receiving device fulfills this purpose.
2. CL_Vref = 0.12*(VccSus3_3).

8.7 Power Sequencing and Reset Signal Timings

Table 8-37. Power Sequencing and Reset Signal Timings (Sheet 1 of 2)

Sym	Parameter	Min	Max	Units	Notes	Fig
t200	VccRTC active to RTCRST# deassertion	9	—	ms		8-1, 8-2
t200a	RTCRST# deassertion to DPWROK high	0	—	ms		8-1, 8-2
t200b	VccDSW3_3 active to DPWROK high	10	—	ms		8-1, 8-2
t200c	VccDSW3_3 active to VccSus3_3 active	0	—	ms		8-1, 8-2
t201	VccSUS active to RSMRST# deassertion	10	—	ms	1	8-1, 8-2
t202	DPWROK high to SLP_SUS# deassertion	95	—	ms	2, 3	8-1, 8-2
t202a	RSMRST# and SLP_SUS# deassertion to SUSCLK toggling	5	—	ms	3, 4	8-1, 8-2
t203	SLP_S5# high to SLP_S4# high	30		μs	5	8-3
t204	SLP_S4# high to SLP_S3# high	30		μs	6	8-3
t205	Vcc active to PWROK high	10	—	ms	7, 13	
t206	PWROK deglitch time	1	—	ms	8	
t207	VccASW active to APWROK high	1	—	ms		
t208	PWROK high to PCH clock outputs stable	1	—	ms	9	
t209	PCH clock output stable to PROCPWRGD high	1	—	ms		
t210	PROCPWRGD and SYS_PWROK high to SUS_STAT# deassertion	1	—	ms		
t211	SUS_STAT# deassertion to PLTRST# deassertion	60	—	μs		
t212	APWROK high to SPI Soft-Strap Reads	500	—	μs	21	
t213	APWROK high to CL_RST1# deasserted	500	—	μs	10	
t214	DMI message and all PCI Express ports and DMI in L2/L3 state to SUS_STAT# active	60	—	μs		8-6



Table 8-37. Power Sequencing and Reset Signal Timings (Sheet 2 of 2)

Sym	Parameter	Min	Max	Units	Notes	Fig	
t215	SUS_STAT# active to PLTRST# active	210	—	μs		8-6	
t217	PLTRST# active to PROCPWRGD inactive	30	—	μs		8-6	
t218	PROCPWRGD inactive to clocks invalid	10	—	μs		8-6	
t219	Clocks invalid to SLP_S3# assertion	1	—	μs		8-6	
t220	SLP_S3# low to SLP_S4# low	30	—	μs		8-6	
t221	SLP_S4# low to SLP_S5# low	30	—	μs		8-6	
t222	SLP_S3# active to PWROK deasserted	0	—			8-6	
t223	PWROK rising to DRAMPWROK rising	0	—	μs		8-8	
t224	DRAMPWROK falling to SLP_S4# falling	-100	—	ns	11	8-8	
t225	VccRTC active to VccDSW3_3 active	0	—	ms	1, 12	8-2	
t226	RTCRST# deassertion to RSMRST# deassertion	20	—	ns		8-2	
t227	VccSus active to VccASW active	0	—	ms	1		
t229	VccASW active to Vcc active	0	—	ms			
t230	APWROK high to PWROK high	0	—	ms			
t231	PWROK low to Vcc falling	40	—	ns	13, 14, 15		
t232	APWROK falling to VccASW falling	40	—	ns	15		
t233	SLP_S3# assertion to VccCore rail falling	5	—	μs	13, 14		
t234	DPWROK falling to VccDSW rail falling	40	—	ns		8-7	
t235	RSMRST# assertion to VccSUS rail falling	40	—	ns	1, 14, 15	8-7	
t236	RTCRST# deassertion to VccRTC rail falling	0	—	ms		8-7	
t237	SLP_LAN# (or LANPHYPC) rising to Intel LAN Phy power high and stable	—	20	ms			
t238	DPWROK falling to any of VccDSW, VccSUS, VccASW, VccASW3_3, or Vcc falling	40	—	ns	1, 13, 14, 15		
t239	V5REF_Sus active to VccSus3_3 active	0	—	ms	16		
t240	V5REF active to Vcc3_3 active	See note 15	—	ms	16		
t241	VccSus supplies active to Vcc supplies active	0	—	ms	1, 13		
t242	HDA_RST# active low pulse width	1	—	μs			
t244	VccSus active to SLP_S5#, SLP_S4#, SLP_S3#, SUS_STAT#, PLTRST# and PCIRST# valid	—	50	ns	20		
t246	S4 Wake Event to SLP_S4# inactive (S4 Wake)	See Note Below				5	
t247	S3 Wake Event to SLP_S3# inactive (S3 Wake)	See Note Below				6	
t251	RSMRST# deassertion to APWROK assertion	0	—	ms			
t252	THRMTRIP# active to SLP_S3#, SLP_S4#, SLP_S5# active	—	175	ns			
t253	RSMRST# rising edge transition from 20% to 80%	—	50	μs			
t254	RSMRST# falling edge transition	—	50	μs	18, 19		

**NOTES:**

1. VccSus supplies include VccSus3_3, V5REF_Sus, and VccSusHDA. Also includes DcpSus for mobile platforms that power DcpSus externally.
2. This timing is a nominal value counted using RTC clock. If RTC clock isn't already stable at the rising edge of RSMRST#, this timing could be shorter or longer than the specified value.
3. Platforms not supporting Deep S4/S5 will typically have SLP_SUS# left as no connect. Hence DPWROK high and RSMRST# deassertion to SUSCLK toggling would be $t_{202} + t_{202a} = 100$ ms minimum.
4. Platforms supporting Deep S4/S5 will have SLP_SUS# deassert prior to RSMRST#. Platforms not supporting Deep S4/S5 will have RSMRST# deassert prior to SLP_SUS#.
5. Dependency on SLP_S4# and SLP_A# stretching
6. Dependency on SLP_S3# and SLP_A# stretching
7. It is required that the power rails associated with PCI/PCIe (typically the 3.3 V, 5 V, and 12 V core well rails) have been valid for 99 ms prior to PWROK assertion in order to comply with the 100 ms PCI/PCIe 2.0 specification on PLTRST# deassertion. System designers must ensure the requirement is met on the platforms.
8. Ensure PWROK is a solid logic '1' before proceeding with the boot sequence.
Note: If PWROK drops after t_{206} it will be considered a power failure.
9. Timing is dependant on whether 25 MHz crystal is stable by the time PWROK is high.
10. Requires SPI messaging to be completed.
11. The negative min timing implies that DRAMPWROK must either fall before SLP_S4# or within 100 ns after it.
12. The VccDSW3_3 supplies must never be active while the VccRTC supply is inactive.
13. Vcc includes VccIO, VccCORE, Vcc3_3, VccADPLLA, VccADPLLB, VccADAC, V5REF, V_PROC_IO, VccCLKDMI, VccDIFFCLKN, VccVRM, VccDFTERM, VccSSC, VccALVDS (mobile only), VccXLVDS (mobile only) and VccASW (if Intel® ME only powered in S0).
14. A Power rail is considered to be inactive when the rail is at its nominal voltage minus 5% or less.
15. Board design may meet (t_{231} AND t_{232} AND t_{235}) OR (t_{238}).
16. V5REF must be powered up before Vcc3_3, or after Vcc3_3 within 0.7 V. Also, V5REF must power down after Vcc3_3, or before Vcc3_3 within 0.7 V. V5REF_Sus must be powered up before VccSus3_3, or after VccSus3_3 within 0.7 V. Also, V5REF_Sus must power down after VccSus3_3, or before VccSus3_3 within 0.7 V.
17. If RTC clock is not already stable at RSMRST# rising edge, this time may be longer.
18. RSMRST# falling edge must transition to 0.8 V or less before VccSus3_3 drops to 2.9 V
19. The 50 μ s should be measured from Vih to Vil (2 V to 0.78 V).
20. This is an internal timing showing when the signals (SLP_S5#, SLP_S4#, SLP_S3#, SUS_STAT#, PLTRST# and PCIRST#) are valid after VccSus rail is Active.
21. APWROK high to SPI Soft-Strap Read is an internal PCH timing. The timing cannot be measured externally and included here for general power sequencing reference.

8.8 Power Management Timing Diagrams

Figure 8-1. G3 w/RTC Loss to S4/S5 (With Deep S4/S5 Support) Timing Diagram

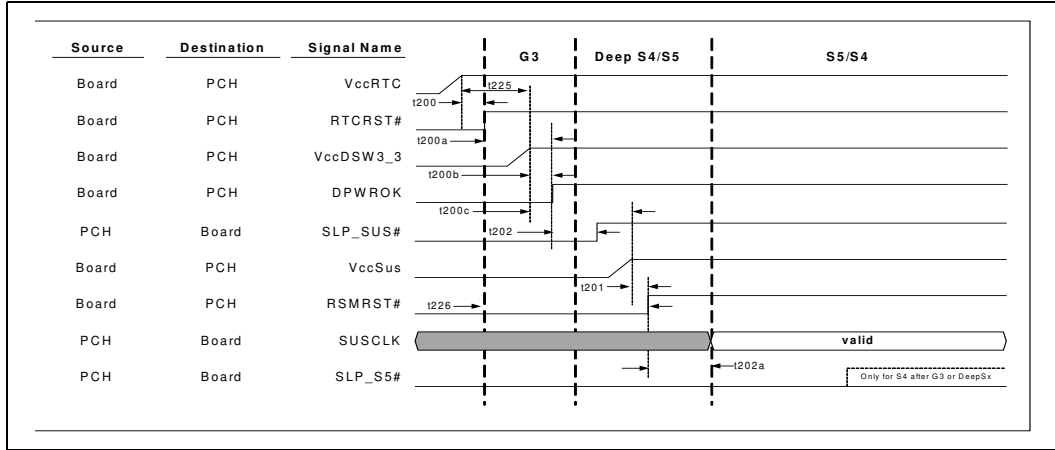
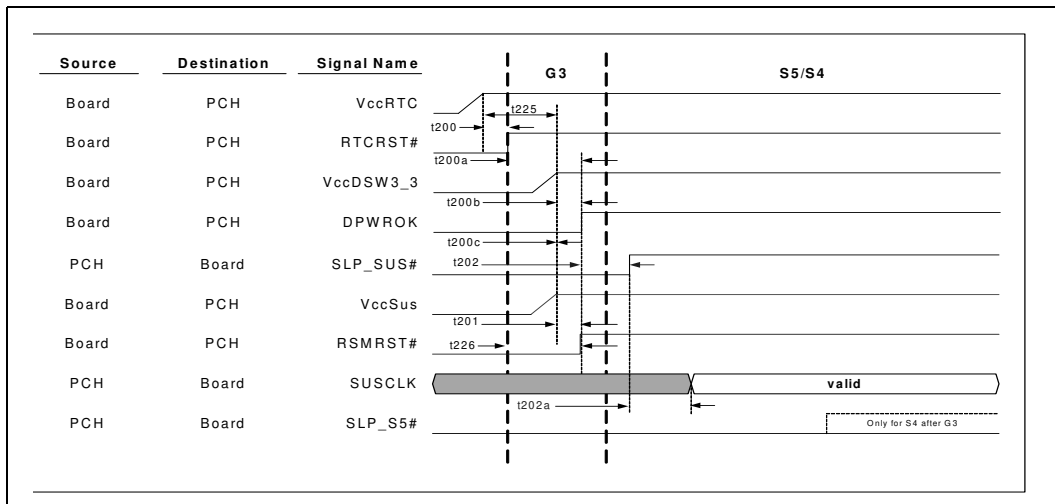

Figure 8-2. G3 w/RTC Loss to S4/S5 (Without Deep S4/S5 Support) Timing Diagram



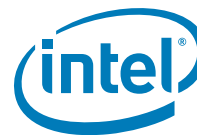

Figure 8-3. S5 to S0 Timing Diagram

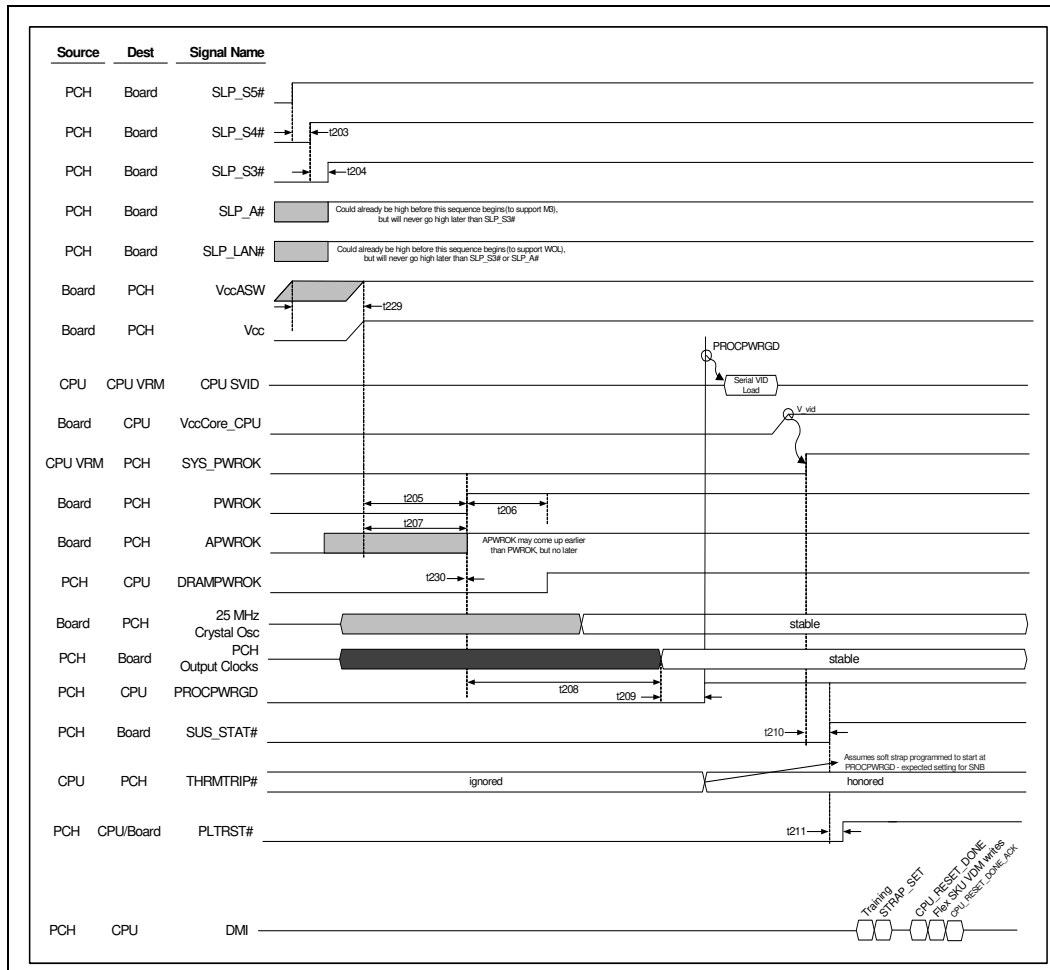

Figure 8-4. S3/M3 to S0 Timing Diagram

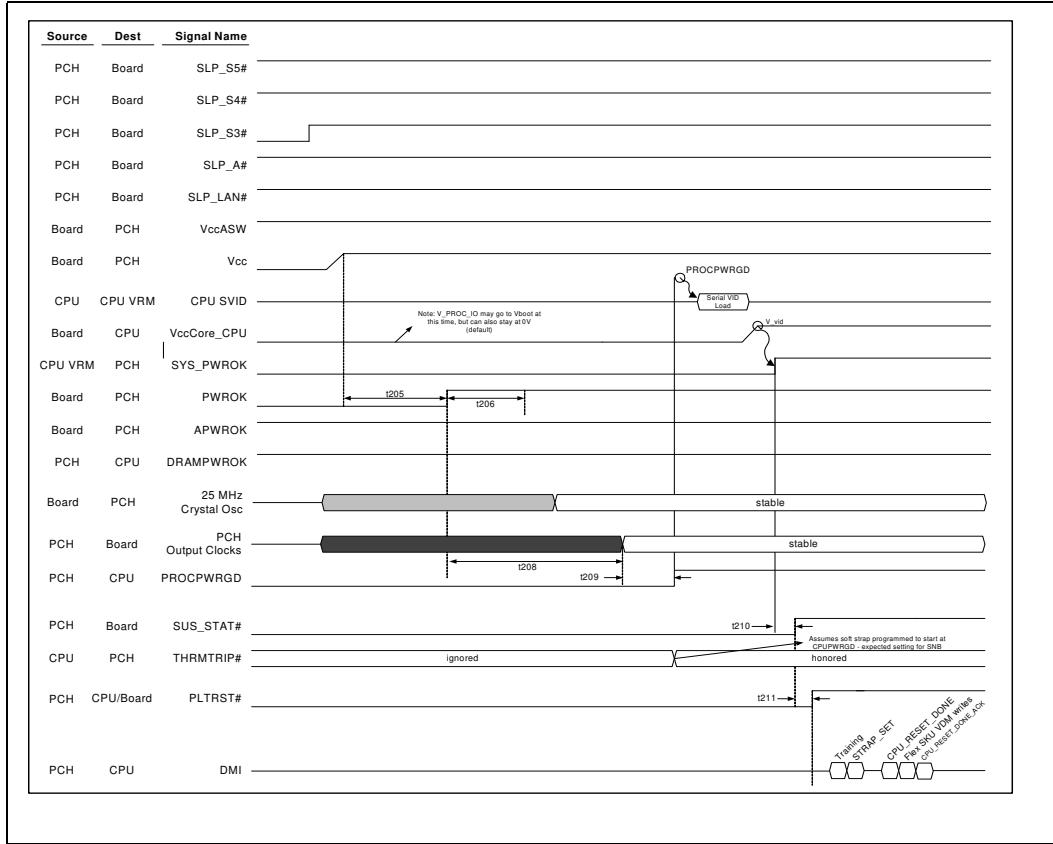

Figure 8-5. S5/Moff - S5/M3 Timing Diagram

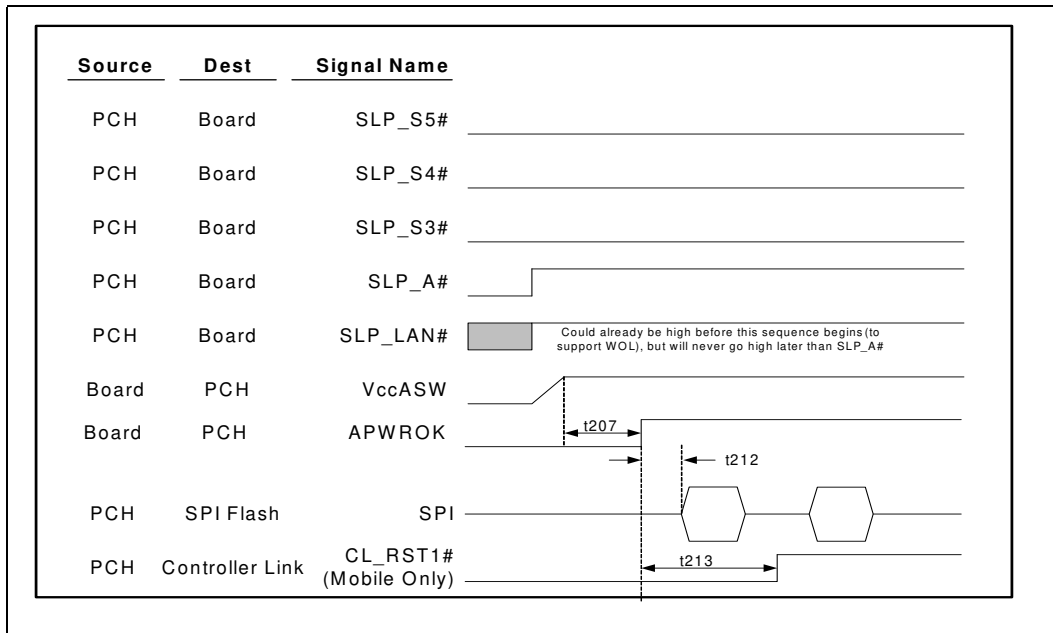



Figure 8-6. S0 to S5 Timing Diagram

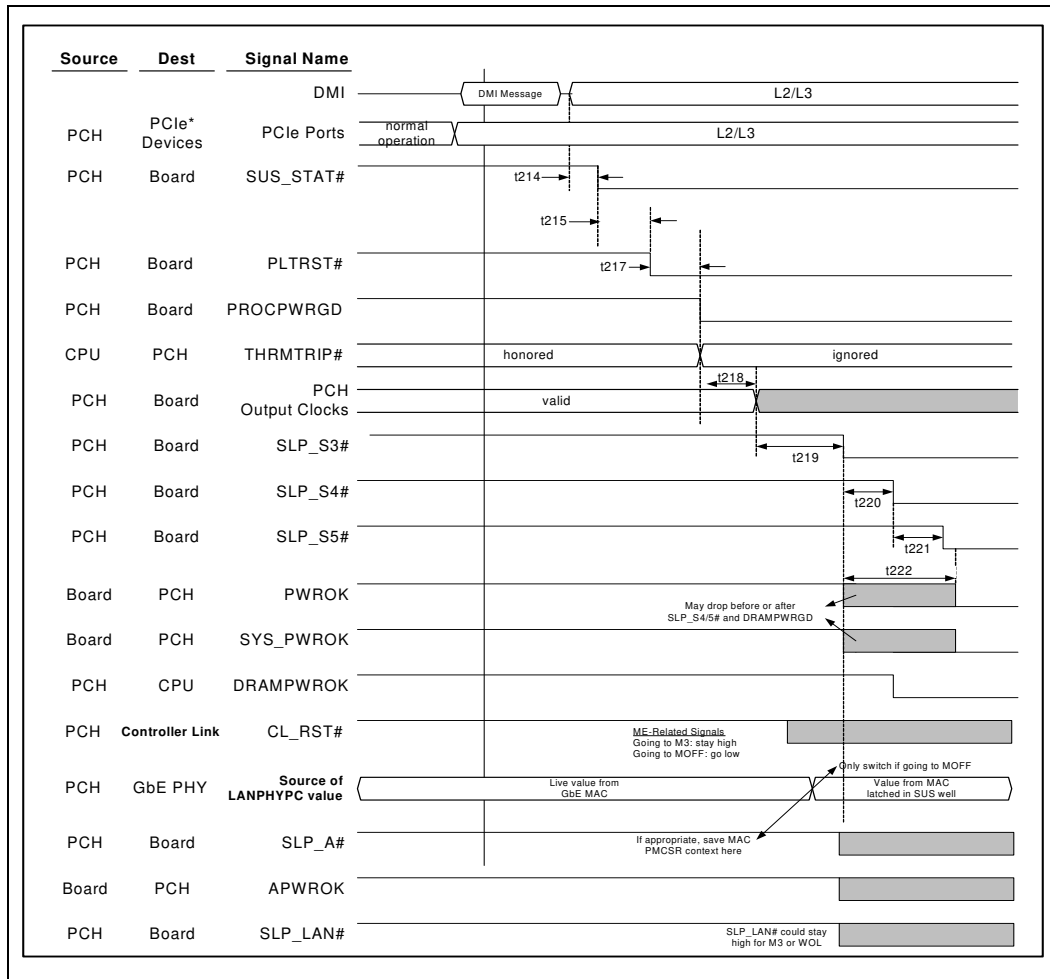

Figure 8-7. S4/S5 to Deep S4/S5 to G3 w/ RTC Loss Timing Diagram

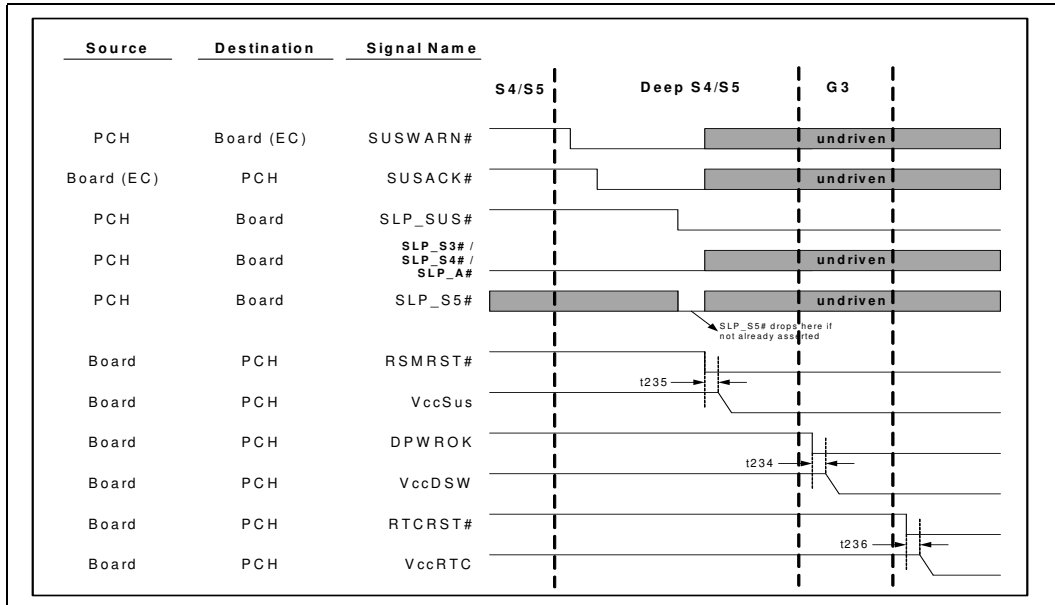
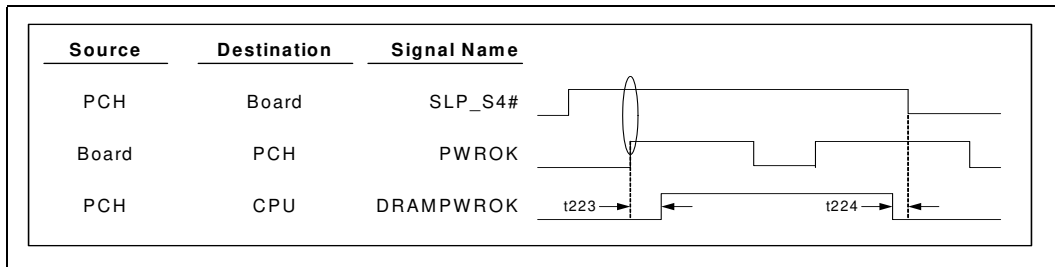

Figure 8-8. DRAMPWROK Timing Diagram





8.9 AC Timing Diagrams

Figure 8-9. Clock Cycle Time

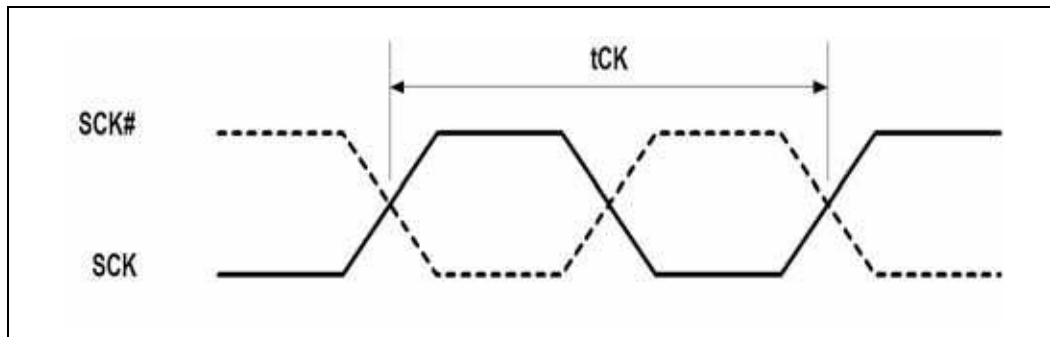

Figure 8-10. Transmitting Position (Data to Strobe)

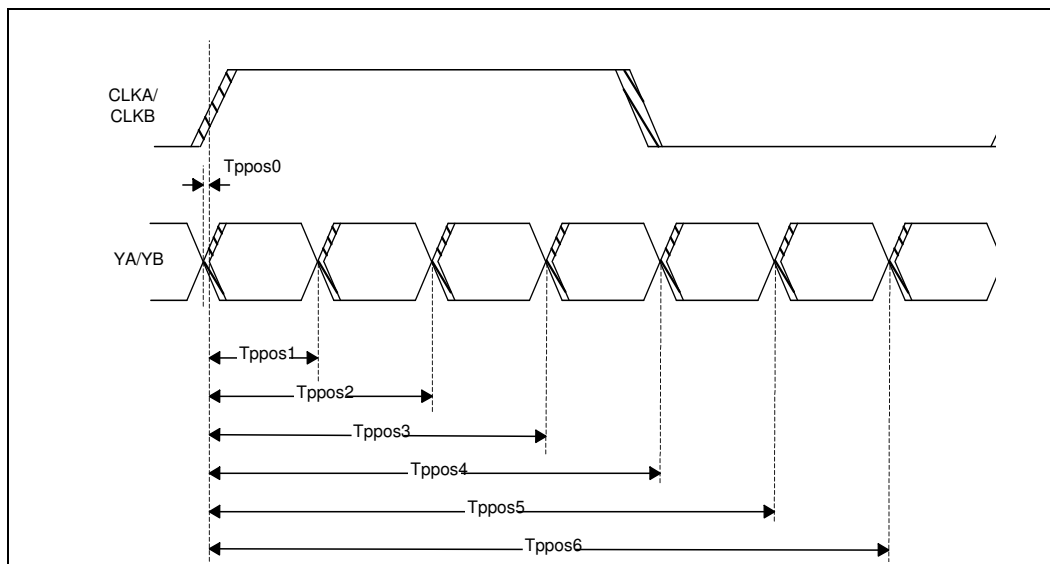

Figure 8-11. Clock Timing

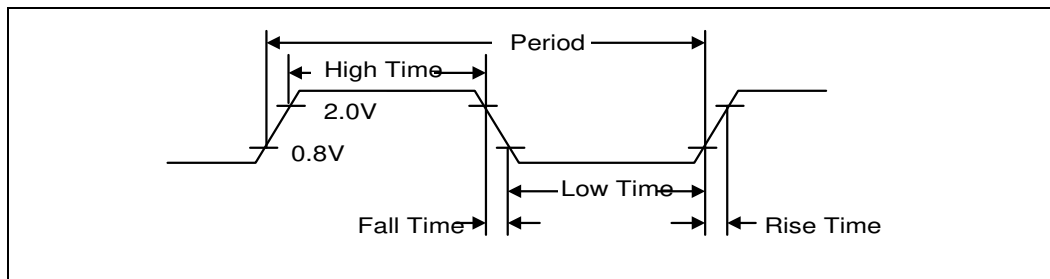

Figure 8-12. Valid Delay from Rising Clock Edge

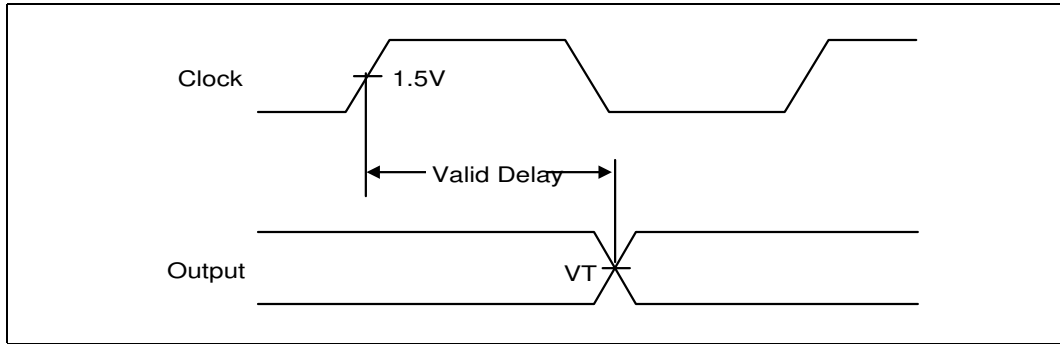

Figure 8-13. Setup and Hold Times

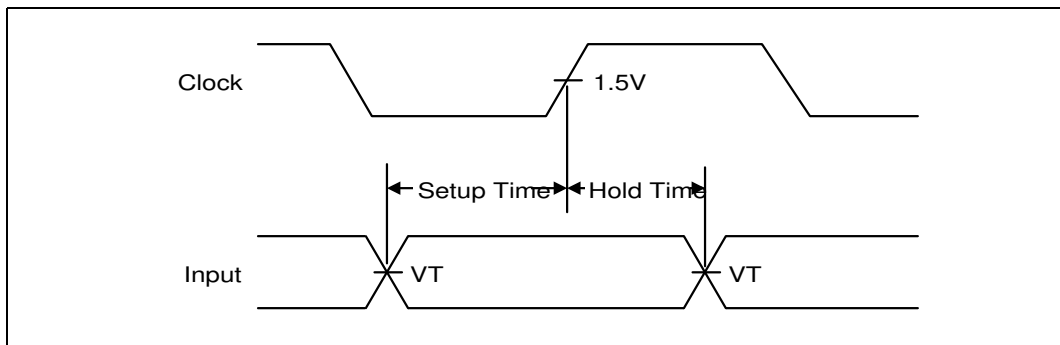

Figure 8-14. Float Delay

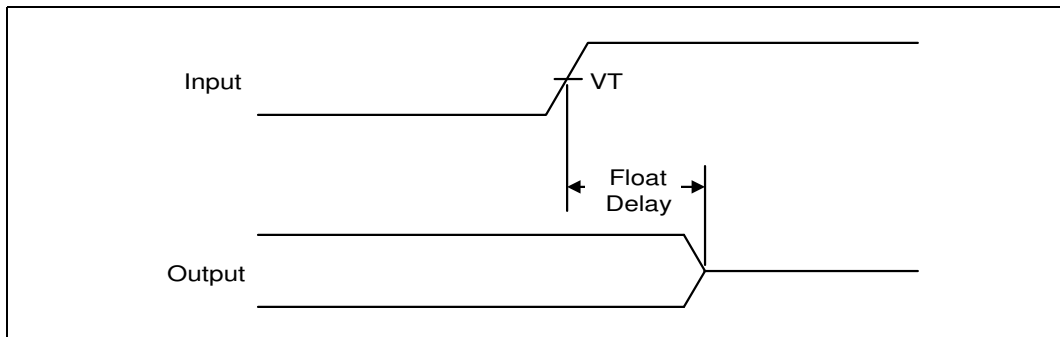
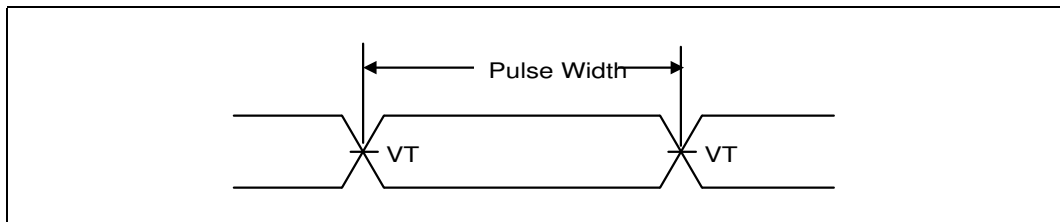

Figure 8-15. Pulse Width



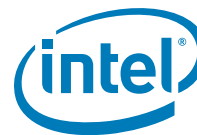

Figure 8-16. Output Enable Delay

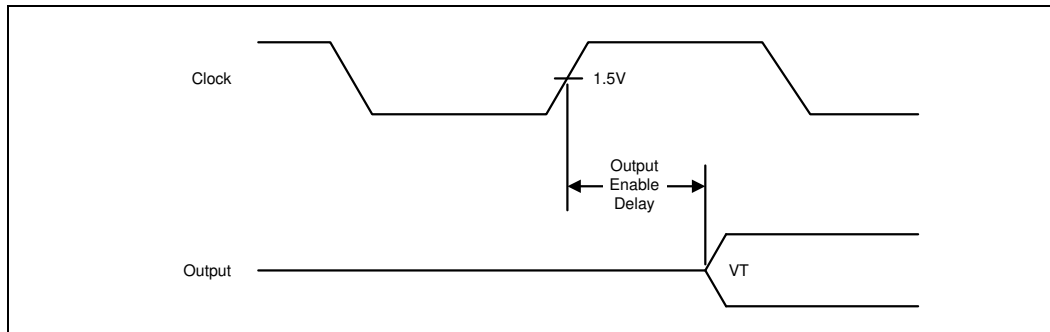

Figure 8-17. USB Rise and Fall Times

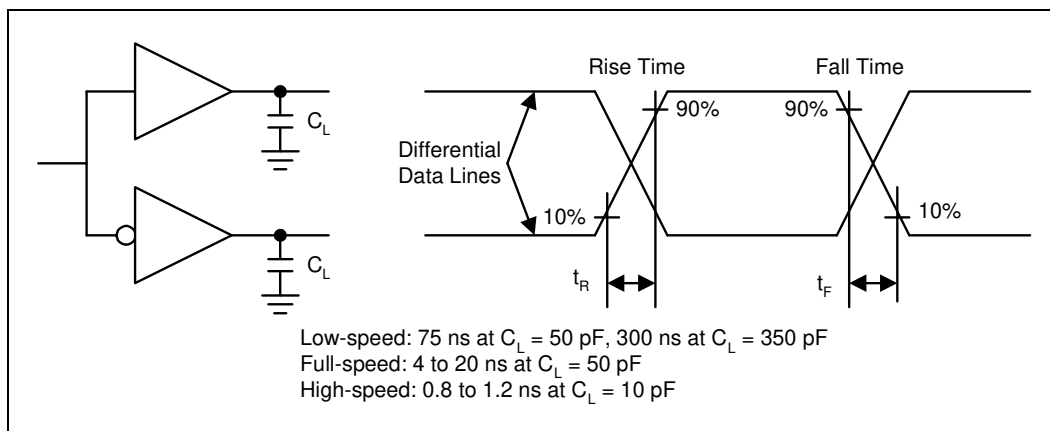

Figure 8-18. USB Jitter

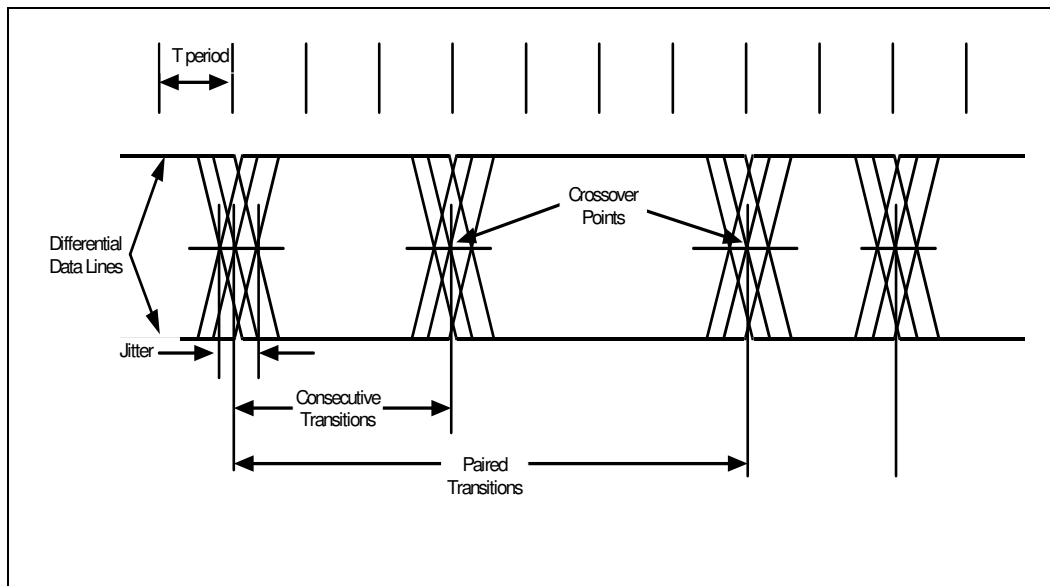

Figure 8-19. USB EOP Width

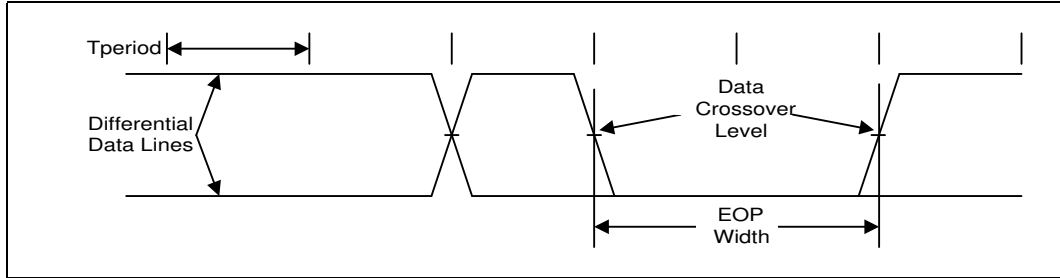

Figure 8-20. SMBus Transaction

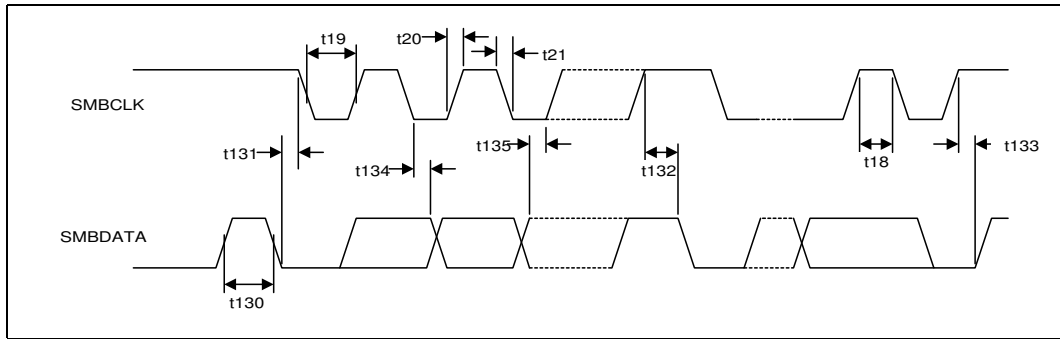

Figure 8-21. SMBus Timeout

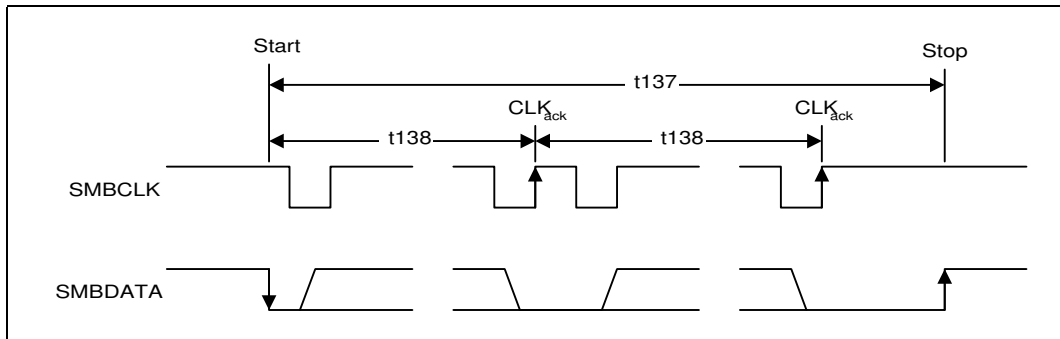



Figure 8-22. SPI Timings

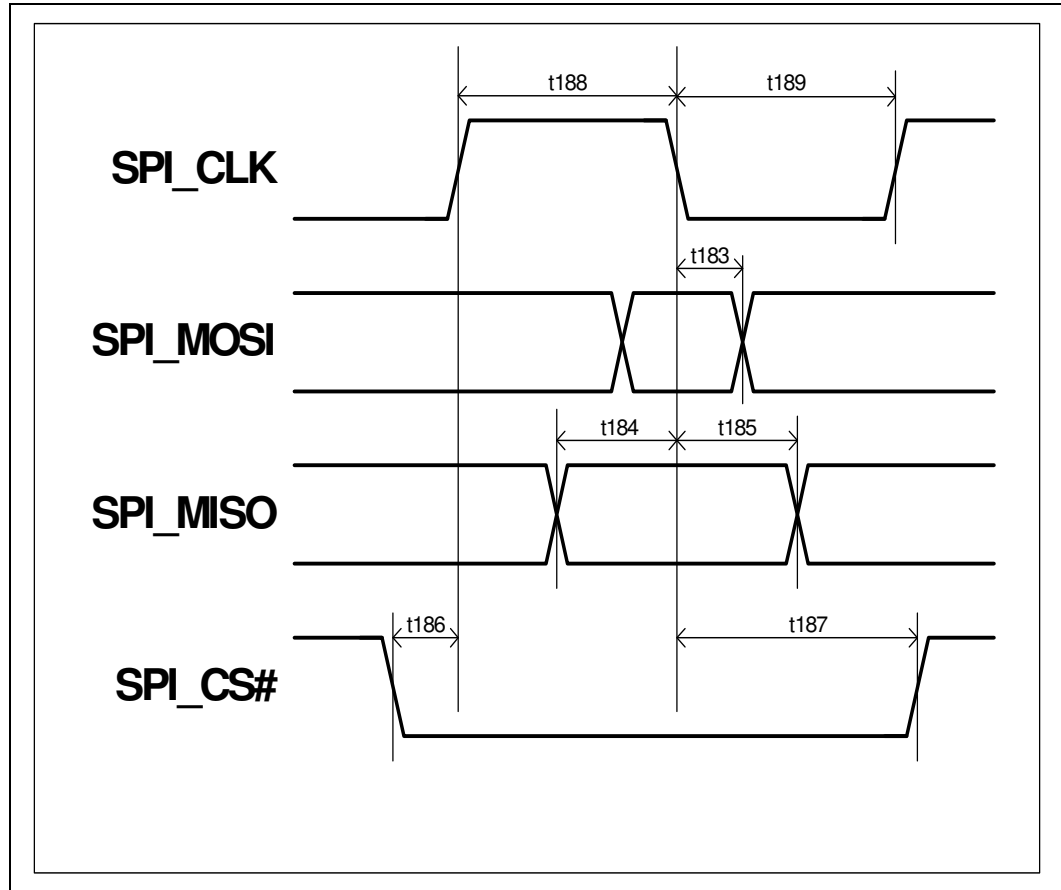

Figure 8-23. Intel® High Definition Audio Input and Output Timings

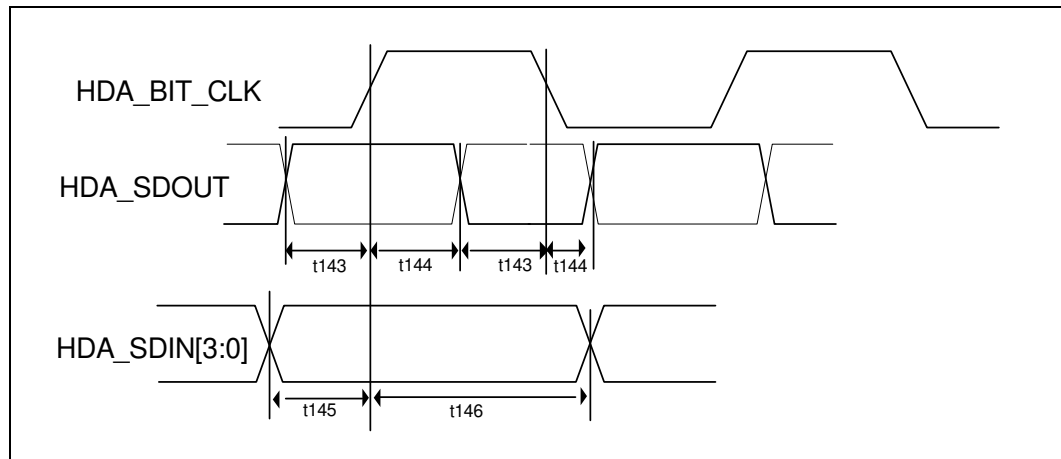

Figure 8-24. Dual Channel Interface Timings

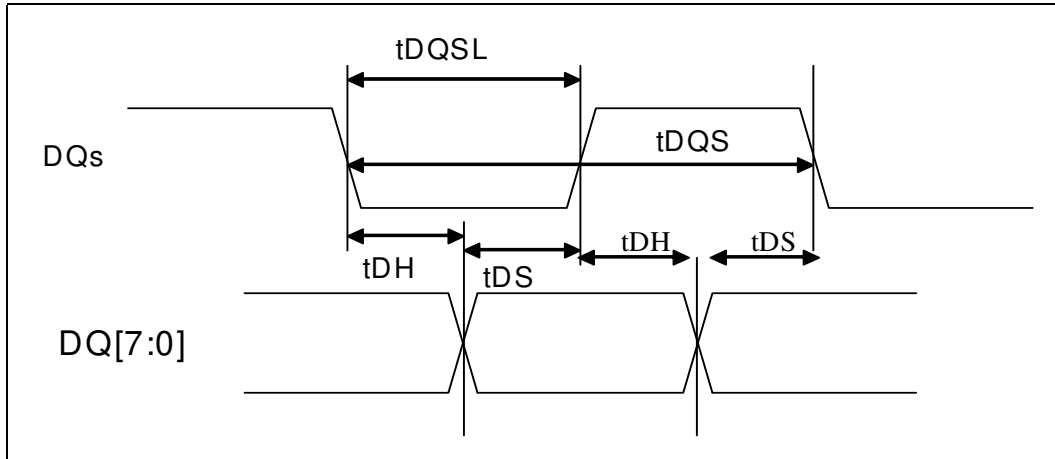

Figure 8-25. Dual Channel Interface Timings

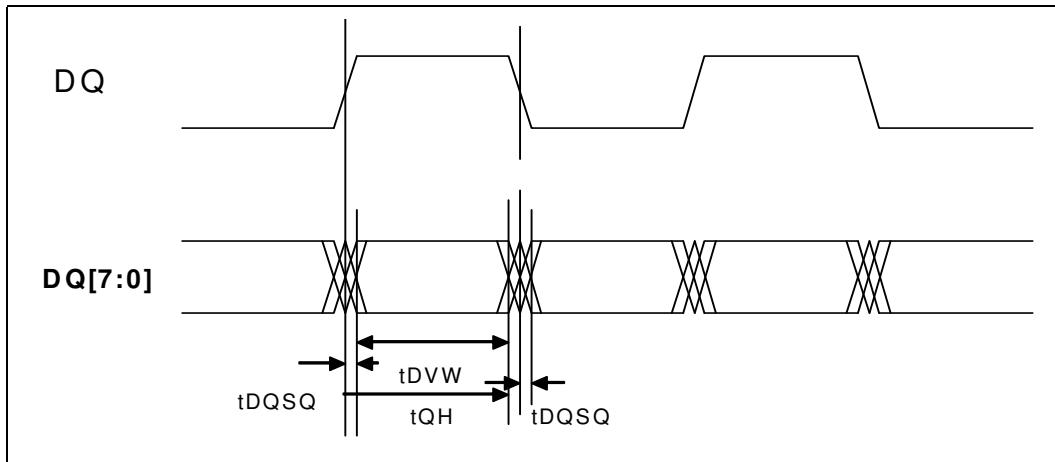

Figure 8-26. LVDS Load and Transition Times

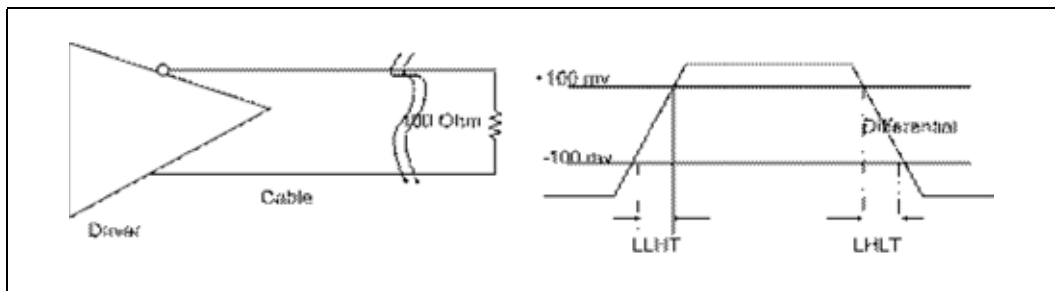



Figure 8-27. Transmitting Position (Data to Strobe)

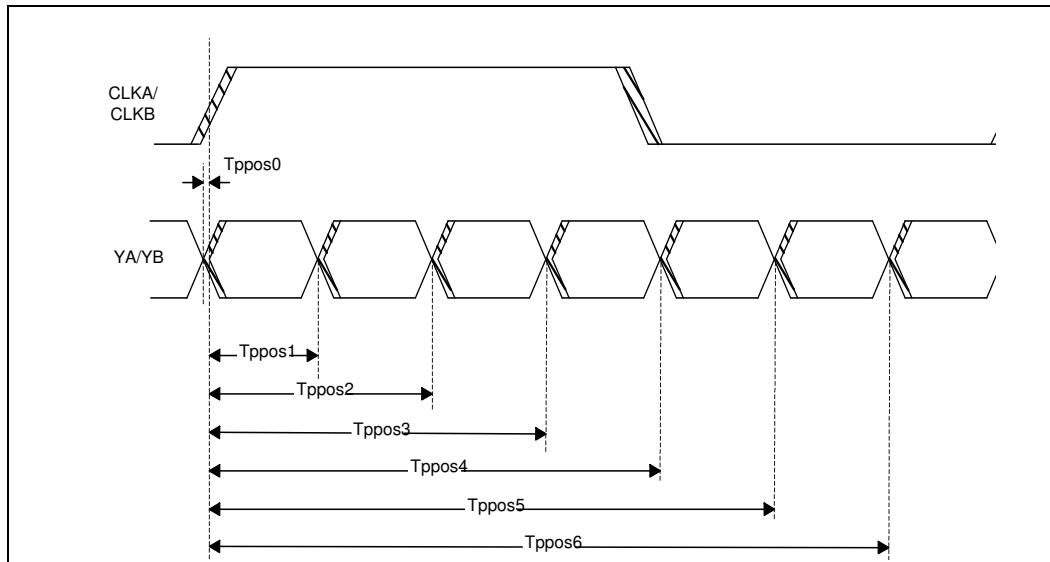

Figure 8-28. PCI Express Transmitter Eye

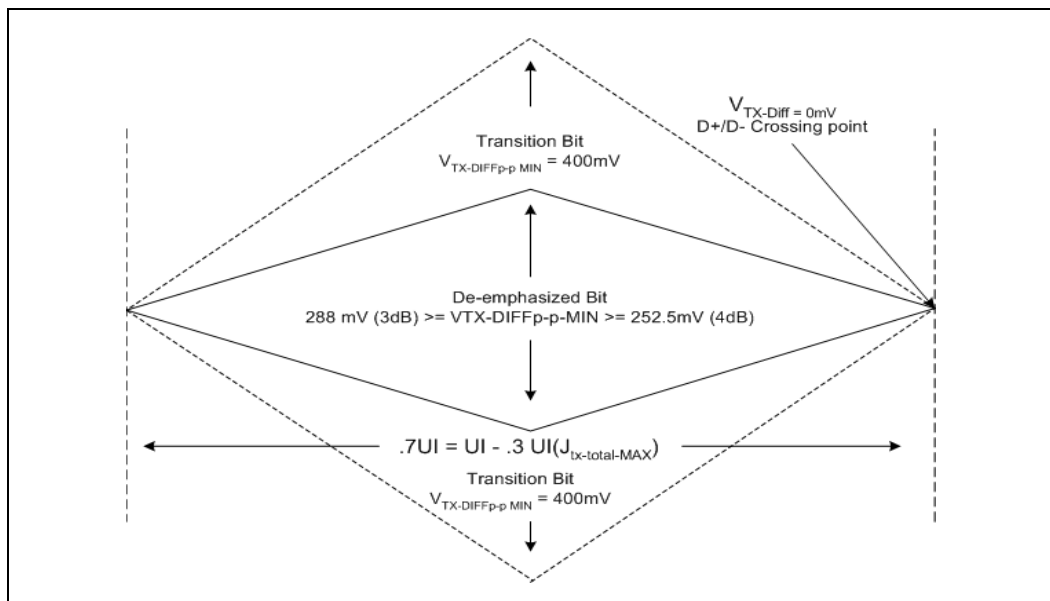

Figure 8-29. PCI Express Receiver Eye

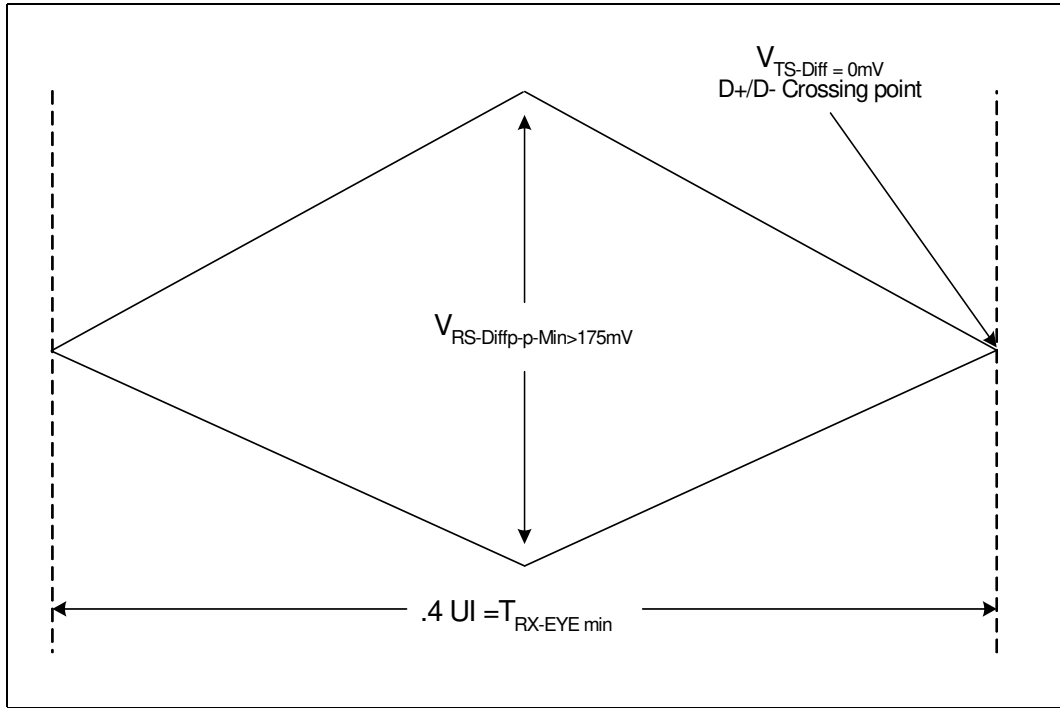



Figure 8-30. Measurement Points for Differential Waveforms.

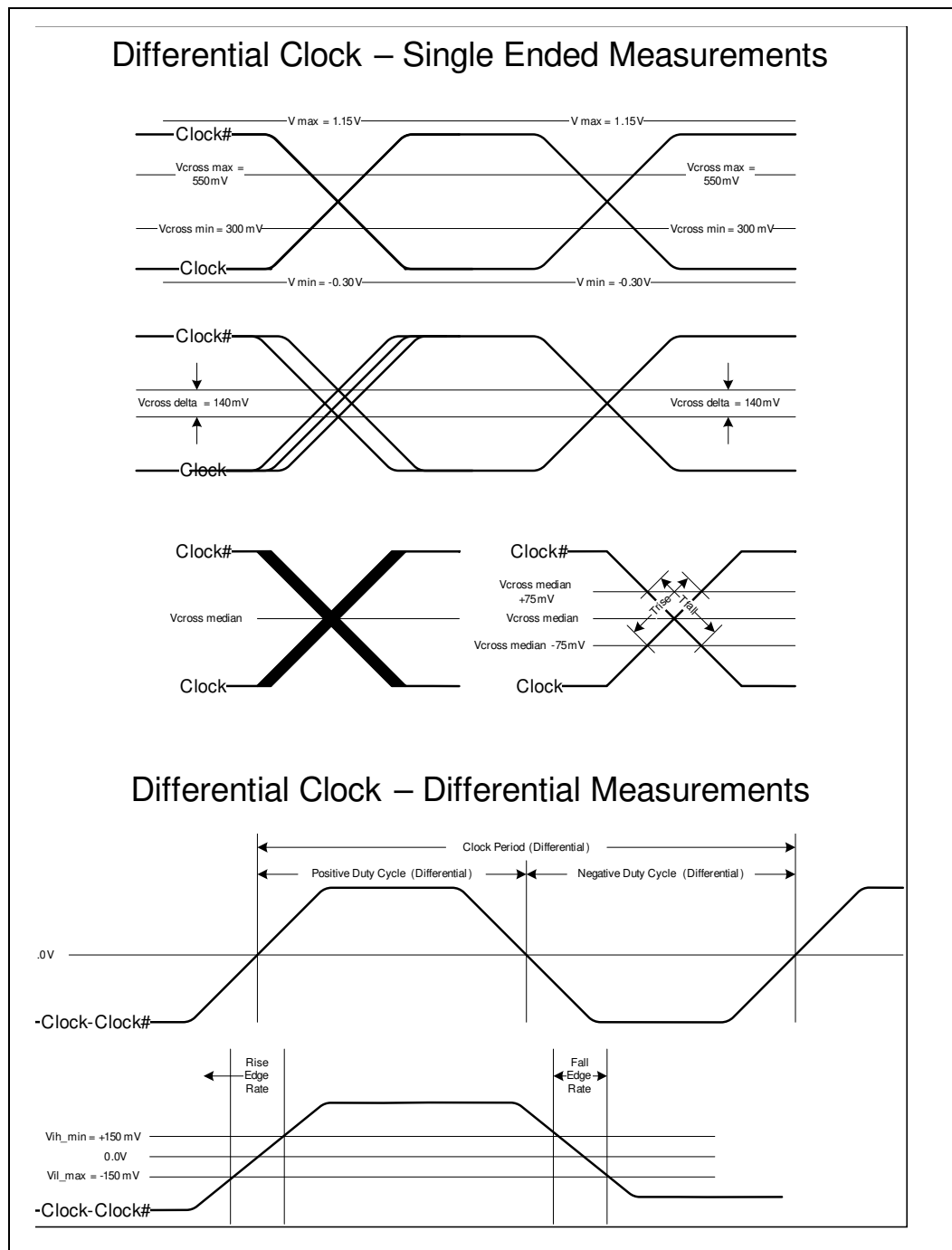

Figure 8-31. PCH Test Load

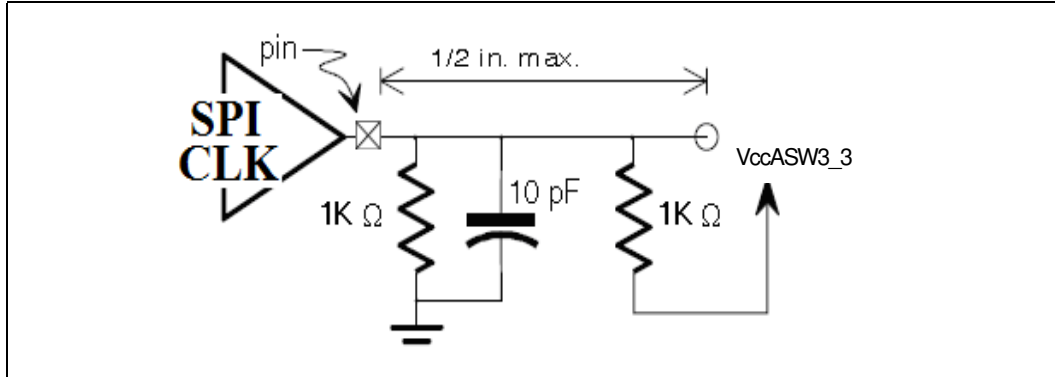

Figure 8-32. Controller Link Receive Timings

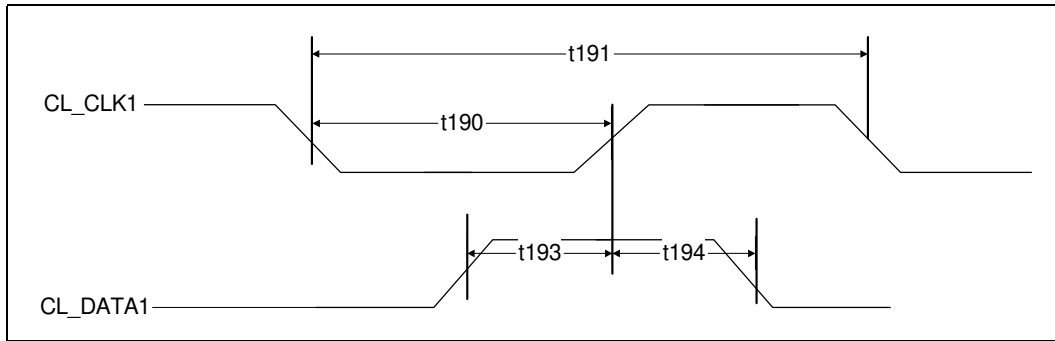
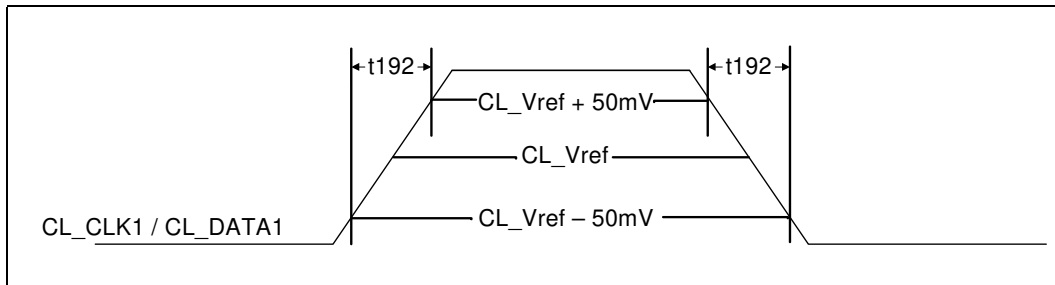

Figure 8-33. Controller Link Receive Slew Rate



§ §



9 Register and Memory Mapping

The PCH contains registers that are located in the processor's I/O space and memory space and sets of PCI configuration registers that are located in PCI configuration space. This chapter describes the PCH I/O and memory maps at the register-set level. Register access is also described. Register-level address maps and Individual register bit descriptions are provided in the following chapters. The following notations and definitions are used in the register/instruction description chapters.

RO	Read Only. In some cases, if a register is read only, writes to this register location have no effect. However, in other cases, two separate registers are located at the same location where a read accesses one of the registers and a write accesses the other register. See the I/O and memory map tables for details.
WO	Write Only. In some cases, if a register is write only, reads to this register location have no effect. However, in other cases, two separate registers are located at the same location where a read accesses one of the registers and a write accesses the other register. See the I/O and memory map tables for details.
R/W	Read/Write. A register with this attribute can be read and written.
R/WC	Read/Write Clear. A register bit with this attribute can be read and written. However, a write of 1 clears (sets to 0) the corresponding bit and a write of 0 has no effect.
R/WO	Read/Write-Once. A register bit with this attribute can be written only once after power up. After the first write, the bit becomes read only.
R/WL	Read/Write Lockable. A register bit with the attribute can be read at any time but writes may only occur if the associated lock bit is set to unlock. If the associated lock bit is set to lock, this register bit becomes RO unless otherwise indicated.
R/WLO	Read/Write, Lock-Once. A register bit with this attribute can be written to the non-locked value multiple times, but to the locked value only once. After the locked value has been written, the bit becomes read only.
Reserved	The value of reserved bits must never be changed. For details see Section 9.2 .
Default	When the PCH is reset, it sets its registers to predetermined default states. It is the responsibility of the system initialization software to determine configuration, operating parameters, and optional system features that are applicable, and to program the PCH registers accordingly.
Bold	Register bits that are highlighted in bold text indicate that the bit is implemented in the PCH. Register bits that are not implemented or are hardwired will remain in plain text.

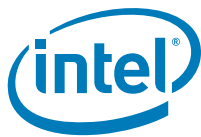

9.1 PCI Devices and Functions

The PCH incorporates a variety of PCI devices and functions, as shown in [Table 9-1](#).

If for some reason, the particular system platform does not want to support any one of the Device Functions, with the exception of D30:F0, can individually be disabled. The integrated Gigabit Ethernet controller will be disabled if no Platform LAN Connect component is detected (See [Section 5.3](#)). When a function is disabled, it does not appear at all to the software. A disabled function will not respond to any register reads or writes, insuring that these devices appear hidden to software.

Table 9-1. PCI Devices and Functions

Bus:Device:Function	Function Description
Bus 0:Device 30:Function 0	PCI-to-PCI Bridge
Bus 0:Device 31:Function 0	LPC Controller ¹
Bus 0:Device 31:Function 2	SATA Controller #1
Bus 0:Device 31:Function 3	SMBus Controller
Bus 0:Device 31:Function 5	SATA Controller #2 ²
Bus 0:Device 31:Function 6	Thermal Subsystem
Bus 0:Device 29:Function 0 ³	USB EHCI Controller #1
Bus 0:Device 26:Function 0 ³	USB EHCI Controller #2
Bus 0:Device 28:Function 0	PCI Express* Port 1
Bus 0:Device 28:Function 1	PCI Express Port 2
Bus 0:Device 28:Function 2	PCI Express Port 3
Bus 0:Device 28:Function 3	PCI Express Port 4
Bus 0:Device 28:Function 4	PCI Express Port 5
Bus 0:Device 28:Function 5	PCI Express Port 6
Bus 0:Device 28:Function 6	PCI Express Port 7
Bus 0:Device 28:Function 7	PCI Express Port 8
Bus 0:Device 27:Function 0	Intel [®] High Definition Audio Controller
Bus 0:Device 25:Function 0	Gigabit Ethernet Controller
Bus 0:Device 22:Function 0	Intel [®] Management Engine Interface #1
Bus 0:Device 22:Function 1	Intel Management Engine Interface #2
Bus 0:Device 22:Function 2	IDE-R
Bus 0:Device 22:Function 3	KT

NOTES:

1. The PCI-to-LPC bridge contains registers that control LPC, Power Management, System Management, GPIO, Processor Interface, RTC, Interrupts, Timers, and DMA.
2. SATA controller 2 (D31:F5) is only visible when D31:F2 CC.SCC=01h.
3. Prior to BIOS initialization of the PCH USB subsystem, the EHCI controllers will appear as Function 7. After BIOS initialization, the EHCI controllers will be Function 0.
4. This table shows the default PCI Express Function Number-to-Root Port mapping. Function numbers for a given root port are assignable through the "Root Port Function Number and Hide for PCI Express Root Ports" register (RCBA+0404h).



9.2 PCI Configuration Map

Each PCI function on the PCH has a set of PCI configuration registers. The register address map tables for these register sets are included at the beginning of the chapter for the particular function.

Configuration Space registers are accessed through configuration cycles on the PCI bus by the Host bridge using configuration mechanism #1 detailed in the *PCI Local Bus Specification, Revision 2.3*.

Some of the PCI registers contain reserved bits. Software must deal correctly with fields that are reserved. On reads, software must use appropriate masks to extract the defined bits and not rely on reserved bits being any particular value. On writes, software must ensure that the values of reserved bit positions are preserved. That is, the values of reserved bit positions must first be read, merged with the new values for other bit positions and then written back. Note the software does not need to perform read, merge, write operation for the configuration address register.

In addition to reserved bits within a register, the configuration space contains reserved locations. Software should not write to reserved PCI configuration locations in the device-specific region (above address offset 3Fh).

9.3 I/O Map

The I/O map is divided into Fixed and Variable address ranges. Fixed ranges cannot be moved, but in some cases can be disabled. Variable ranges can be moved and can also be disabled.

9.3.1 Fixed I/O Address Ranges

Table 9-2 shows the Fixed I/O decode ranges from the processor perspective. Note that for each I/O range, there may be separate behavior for reads and writes. DMI (Direct Media Interface) cycles that go to target ranges that are marked as "Reserved" will not be decoded by the PCH, and will be passed to PCI unless the Subtractive Decode Policy bit is set (D31:F0:Offset 42h, bit 0). If a PCI master targets one of the fixed I/O target ranges, it will be positively decoded by the PCH in medium speed.

Address ranges that are not listed or marked "Reserved" are **not** decoded by the PCH (unless assigned to one of the variable ranges).



Table 9-2. Fixed I/O Ranges Decoded by PCH (Sheet 1 of 2)

I/O Address	Read Target	Write Target	Internal Unit
00h–08h	DMA Controller	DMA Controller	DMA
09h–0Eh	RESERVED	DMA Controller	DMA
0Fh	DMA Controller	DMA Controller	DMA
10h–18h	DMA Controller	DMA Controller	DMA
19h–1Eh	RESERVED	DMA Controller	DMA
1Fh	DMA Controller	DMA Controller	DMA
20h–21h	Interrupt Controller	Interrupt Controller	Interrupt
24h–25h	Interrupt Controller	Interrupt Controller	Interrupt
28h–29h	Interrupt Controller	Interrupt Controller	Interrupt
2Ch–2Dh	Interrupt Controller	Interrupt Controller	Interrupt
2Eh–2Fh	LPC SIO	LPC SIO	Forwarded to LPC
30h–31h	Interrupt Controller	Interrupt Controller	Interrupt
34h–35h	Interrupt Controller	Interrupt Controller	Interrupt
38h–39h	Interrupt Controller	Interrupt Controller	Interrupt
3Ch–3Dh	Interrupt Controller	Interrupt Controller	Interrupt
40h–42h	Timer/Counter	Timer/Counter	PIT (8254)
43h	RESERVED	Timer/Counter	PIT
4Eh–4Fh	LPC SIO	LPC SIO	Forwarded to LPC
50h–52h	Timer/Counter	Timer/Counter	PIT
53h	RESERVED	Timer/Counter	PIT
60h	Microcontroller	Microcontroller	Forwarded to LPC
61h	NMI Controller	NMI Controller	Processor I/F
62h	Microcontroller	Microcontroller	Forwarded to LPC
64h	Microcontroller	Microcontroller	Forwarded to LPC
66h	Microcontroller	Microcontroller	Forwarded to LPC
70h	RESERVED ¹	NMI and RTC Controller	RTC
71h	RTC Controller	RTC Controller	RTC
72h	RTC Controller	NMI and RTC Controller	RTC
73h	RTC Controller	RTC Controller	RTC
74h	RTC Controller	NMI and RTC Controller	RTC
75h	RTC Controller	RTC Controller	RTC
76h	RTC Controller	NMI and RTC Controller	RTC
77h	RTC Controller	RTC Controller	RTC
80h	DMA Controller, LPC, PCI, or PCIe	DMA Controller and LPC, PCI, or PCIe	DMA
81h–83h	DMA Controller	DMA Controller	DMA
84h–86h	DMA Controller	DMA Controller and LPC, PCI, or PCIe	DMA
87h	DMA Controller	DMA Controller	DMA
88h	DMA Controller	DMA Controller and LPC, PCI, or PCIe	DMA
89h–8Bh	DMA Controller	DMA Controller	DMA
8Ch–8Eh	DMA Controller	DMA Controller and LPC, PCI, or PCIe	DMA

**Table 9-2. Fixed I/O Ranges Decoded by PCH (Sheet 2 of 2)**

I/O Address	Read Target	Write Target	Internal Unit
8Fh	DMA Controller	DMA Controller	DMA
90h–91h	DMA Controller	DMA Controller	DMA
92h	Reset Generator	Reset Generator	Processor I/F
93h–9Fh	DMA Controller	DMA Controller	DMA
A0h–A1h	Interrupt Controller	Interrupt Controller	Interrupt
A4h–A5h	Interrupt Controller	Interrupt Controller	Interrupt
A8h–A9h	Interrupt Controller	Interrupt Controller	Interrupt
ACh–ADh	Interrupt Controller	Interrupt Controller	Interrupt
B0h–B1h	Interrupt Controller	Interrupt Controller	Interrupt
B2h–B3h	Power Management	Power Management	Power Management
B4h–B5h	Interrupt Controller	Interrupt Controller	Interrupt
B8h–B9h	Interrupt Controller	Interrupt Controller	Interrupt
BCh–BDh	Interrupt Controller	Interrupt Controller	Interrupt
C0h–D1h	DMA Controller	DMA Controller	DMA
D2h–DDh	RESERVED	DMA Controller	DMA
DEh–DFh	DMA Controller	DMA Controller	DMA
F0h	FERR# / Interrupt Controller	FERR# / Interrupt Controller	Processor I/F
170h–177h	SATA Controller, PCI, or PCIe	SATA Controller, PCI, or PCIe	SATA
1F0h–1F7h	SATA Controller, PCI, or PCIe	SATA Controller, PCI, or PCIe	SATA
200h–207h	Gameport Low	Gameport Low	Forwarded to LPC
208h–20Fh	Gameport High	Gameport High	Forwarded to LPC
376h	SATA Controller, PCI, or PCIe	SATA Controller, PCI, or PCIe	SATA
3F6h	SATA Controller, PCI, or PCIe	SATA Controller, PCI, or PCIe	SATA
4D0h–4D1h	Interrupt Controller	Interrupt Controller	Interrupt
CF9h	Reset Generator	Reset Generator	Processor I/F

NOTE:

1. See [Section 13.7.2](#)



9.3.2 Variable I/O Decode Ranges

Table 9-3 shows the Variable I/O Decode Ranges. They are set using Base Address Registers (BARs) or other configuration bits in the various PCI configuration spaces. The PNP software (PCI or ACPI) can use their configuration mechanisms to set and adjust these values.

Warning: The Variable I/O Ranges should not be set to conflict with the Fixed I/O Ranges. Unpredictable results if the configuration software allows conflicts to occur. The PCH does not perform any checks for conflicts.

Table 9-3. Variable I/O Decode Ranges

Range Name	Mappable	Size (Bytes)	Target
ACPI	Anywhere in 64 KB I/O Space	64	Power Management
IDE Bus Master	Anywhere in 64 KB I/O Space	1. 16 or 32 2. 16	1. SATA Host Controller #1, #2 2. IDE-R
Native IDE Command	Anywhere in 64 KB I/O Space ¹	8	1. SATA Host Controller #1, #2 2. IDE-R
Native IDE Control	Anywhere in 64 KB I/O Space ¹	4	1. SATA Host Controller #1, #2 2. IDE-R
SATA Index/Data Pair	Anywhere in 64 KB I/O Space	16	SATA Host Controller #1, #2
SMBus	Anywhere in 64 KB I/O Space	32	SMB Unit
TCO	96 Bytes above ACPI Base	32	TCO Unit
GPIO	Anywhere in 64 KB I/O Space	128	GPIO Unit
Parallel Port	3 Ranges in 64 KB I/O Space	8 ³	LPC Peripheral
Serial Port 1	8 Ranges in 64 KB I/O Space	8	LPC Peripheral
Serial Port 2	8 Ranges in 64 KB I/O Space	8	LPC Peripheral
Floppy Disk Controller	2 Ranges in 64 KB I/O Space	8	LPC Peripheral
LAN	Anywhere in 64 KB I/O Space	32 ²	LAN Unit
LPC Generic 1	Anywhere in 64 KB I/O Space	4 to 256	LPC Peripheral
LPC Generic 2	Anywhere in 64 KB I/O Space	4 to 256	LPC Peripheral
LPC Generic 3	Anywhere in 64 KB I/O Space	4 to 256	LPC Peripheral
LPC Generic 4	Anywhere in 64 KB I/O Space	4 to 256	LPC Peripheral
I/O Trapping Ranges	Anywhere in 64 KB I/O Space	1 to 256	Trap on Backbone
PCI Bridge	Anywhere in 64 KB I/O Space	I/O Base/ Limit	PCI Bridge
PCI Express Root Ports	Anywhere in 64 KB I/O Space	I/O Base/ Limit	PCI Express Root Ports 1-8
KT	Anywhere in 64 KB I/O Space	8	KT

NOTE:

1. All ranges are decoded directly from DMI. The I/O cycles will not be seen on PCI, except the range associated with PCI bridge.



2. The LAN range is typically not used, as the registers can also be accessed via a memory space.
3. There is also an alias 400h above the parallel port range that is used for ECP parallel ports.

9.4 Memory Map

Table 9-4 shows (from the processor perspective) the memory ranges that the PCH decodes. Cycles that arrive from DMI that are not directed to any of the internal memory targets that decode directly from DMI will be driven out on PCI unless the Subtractive Decode Policy bit is set (D31:F0:Offset 42h, bit 0).

PCI cycles generated by external PCI masters will be positively decoded unless they fall in the PCI-to-PCI bridge memory forwarding ranges (those addresses are reserved for PCI peer-to-peer traffic). If the cycle is not in the internal LAN controller's range, it will be forwarded up to DMI. Software must not attempt locks to the PCH memory-mapped I/O ranges for EHCI and HPET. If attempted, the lock is not honored which means potential deadlock conditions may occur.

Table 9-4. Memory Decode Ranges from Processor Perspective (Sheet 1 of 3)

Memory Range	Target	Dependency/Comments
0000 0000h–000D FFFFh 0010 0000h–TOM (Top of Memory)	Main Memory	TOM registers in Host controller
000E 0000h–000E FFFFh	LPC or SPI	Bit 6 in BIOS Decode Enable register is set
000F 0000h–000F FFFFh	LPC or SPI	Bit 7 in BIOS Decode Enable register is set
FEC_ _000h–FEC_ _040h	IO(x) APIC inside PCH	_ _ is controlled using APIC Range Select (ASEL) field and APIC Enable (AEN) bit
FEC1 0000h–FEC1 7FFF	PCI Express* Port 1	PCI Express* Root Port 1 I/OxAPIC Enable (PAE) set
FEC1 8000h–FEC1 8FFFh	PCI Express* Port 2	PCI Express* Root Port 2 I/OxAPIC Enable (PAE) set
FEC2 0000h–FEC2 7FFFh	PCI Express* Port 3	PCI Express* Root Port 3 I/OxAPIC Enable (PAE) set
FEC2 8000h–FEC2 8FFFh	PCI Express* Port 4	PCI Express* Root Port 4 I/OxAPIC Enable (PAE) set
FEC3 0000h–FEC3 7FFFh	PCI Express* Port 5	PCI Express* Root Port 5 I/OxAPIC Enable (PAE) set
FEC3 8000h–FEC3 8FFFh	PCI Express* Port 6	PCI Express* Root Port 6 I/OxAPIC Enable (PAE) set
FEC4 0000h–FEC4 7FFF	PCI Express* Port 7	PCI Express* Root Port 7 I/OxAPIC Enable (PAE) set
FEC4 8000h–FEC4 FFFF	PCI Express* Port 8	PCI Express* Root Port 8 I/OxAPIC Enable (PAE) set
FFC0 0000h–FFC7 FFFFh FF80 0000h–FF87 FFFFh	LPC or SPI (or PCI) ²	Bit 8 in BIOS Decode Enable register is set
FFC8 0000h–FFCF FFFFh FF88 0000h–FF8F FFFFh	LPC or SPI (or PCI) ²	Bit 9 in BIOS Decode Enable register is set
FFD0 0000h–FFD7 FFFFh FF90 0000h–FF97 FFFFh	LPC or SPI (or PCI) ²	Bit 10 in BIOS Decode Enable register is set
FFD8 0000h–FFDF FFFFh FF98 0000h–FF9F FFFFh	LPC or SPI (or PCI) ²	Bit 11 in BIOS Decode Enable register is set
FFE0 000h–FFE7 FFFFh FFA0 0000h–FFA7 FFFFh	LPC or SPI (or PCI) ²	Bit 12 in BIOS Decode Enable register is set
FFE8 0000h–FFEF FFFFh FFA8 0000h–FFAF FFFFh	LPC or SPI (or PCI) ³	Bit 13 in BIOS Decode Enable register is set

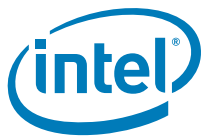

Table 9-4. Memory Decode Ranges from Processor Perspective (Sheet 2 of 3)

Memory Range	Target	Dependency/Comments
FFF0 0000h–FFF7 FFFFh FFB0 0000h–FFB7 FFFFh	LPC or SPI (or PCI) ²	Bit 14 in BIOS Decode Enable register is set
FFF8 0000h–FFFF FFFFh FFB8 0000h–FFBF FFFFh	LPC or SPI (or PCI) ²	Always enabled. The top two 64 KB blocks of this range can be swapped, as described in Section 9.4.1 .
FF70 0000h–FF7F FFFFh FF30 0000h–FF3F FFFFh	LPC or SPI (or PCI) ²	Bit 3 in BIOS Decode Enable register is set
FF60 0000h–FF6F FFFFh FF20 0000h–FF2F FFFFh	LPC or SPI (or PCI) ²	Bit 2 in BIOS Decode Enable register is set
FF50 0000h–FF5F FFFFh FF10 0000h–FF1F FFFFh	LPC or SPI (or PCI) ²	Bit 1 in BIOS Decode Enable register is set
FF40 0000h–FF4F FFFFh FF00 0000h–FF0F FFFFh	LPC or SPI (or PCI) ²	Bit 0 in BIOS Decode Enable register is set
128 KB anywhere in 4 GB range	Integrated LAN Controller	Enable using BAR in Device 25:Function 0 (Integrated LAN Controller MBARA)
4 KB anywhere in 4 GB range	Integrated LAN Controller	Enable using BAR in Device 25:Function 0 (Integrated LAN Controller MBARB)
1 KB anywhere in 4 GB range	USB EHCI Controller #11	Enable using standard PCI mechanism (Device 29, Function 0)
1 KB anywhere in 4 GB range	USB EHCI Controller #21	Enable using standard PCI mechanism (Device 26, Function 0)
16 KB anywhere in 64-bit addressing space	Intel® High Definition Audio Host Controller	Enable using standard PCI mechanism (Device 27, Function 0)
FED0 X000h–FED0 X3FFh	High Precision Event Timers 1	BIOS determines the “fixed” location which is one of four, 1-KB ranges where X (in the first column) is 0h, 1h, 2h, or 3h.
FED4 0000h–FED4 FFFFh	TPM on LPC	None
Memory Base/Limit anywhere in 4 GB range	PCI Bridge	Enable via standard PCI mechanism (Device 30: Function 0)
Prefetchable Memory Base/Limit anywhere in 64-bit address range	PCI Bridge	Enable via standard PCI mechanism (Device 30: Function 0)
64 KB anywhere in 4 GB range	LPC	LPC Generic Memory Range. Enable via setting bit[0] of the LPC Generic Memory Range register (D31:F0:offset 98h).
32 Bytes anywhere in 64-bit address range	SMBus	Enable via standard PCI mechanism (Device 31: Function 3)
2 KB anywhere above 64 KB to 4 GB range	SATA Host Controller #1	AHCI memory-mapped registers. Enable via standard PCI mechanism (Device 31: Function 2)
Memory Base/Limit anywhere in 4 GB range	PCI Express Root Ports 1-8	Enable via standard PCI mechanism (Device 28: Function 0-7)
Prefetchable Memory Base/Limit anywhere in 64-bit address range	PCI Express Root Ports 1-8	Enable via standard PCI mechanism (Device 28: Function 0-7)

**Table 9-4. Memory Decode Ranges from Processor Perspective (Sheet 3 of 3)**

Memory Range	Target	Dependency/Comments
4 KB anywhere in 64-bit address range	Thermal Reporting	Enable via standard PCI mechanism (Device 31: Function 6 TBAR/TBARH)
4 KB anywhere in 64-bit address range	Thermal Reporting	Enable via standard PCI mechanism (Device 31: Function 6 TBARB/TBARBH)
16 Bytes anywhere in 64-bit address range	Intel® MEI #1, #2	Enable via standard PCI mechanism (Device 22: Function 1:0)
4 KB anywhere in 4 GB range	KT	Enable via standard PCI mechanism (Device 22: Function 3)
16 KB anywhere in 4 GB range	Root Complex Register Block (RCRB)	Enable via setting bit[0] of the Root Complex Base Address register (D31:F0:offset F0h).

NOTES:

- Software must not attempt locks to memory mapped I/O ranges for USB EHCI or High Precision Event Timers. If attempted, the lock is not honored, which means potential deadlock conditions may occur.
- PCI is the target when the Boot BIOS Destination selection bits are set to 10b (Chipset Config Registers:Offset 3401 bits 11:10). When PCI selected, the Firmware Hub Decode Enable bits have no effect.

9.4.1 Boot-Block Update Scheme

The PCH supports a “top-block swap” mode that has the PCH swap the top block in the FWH or SPI flash (the boot block) with another location. This allows for safe update of the Boot Block (even if a power failure occurs). When the “Top Swap” Enable bit is set, the PCH will invert A16 for cycles going to the upper two 64 KB blocks in the FWH or appropriate address lines as selected in Boot Block Size (BOOT_BLOCK_SIZE) soft strap for SPI.

Specifically for FHW, in this mode accesses to FFFF_0000h–FFFF_FFFFh are directed to FFFE_0000h–FFFE_FFFFh and vice versa. When the Top Swap Enable bit is 0, the PCH will not invert A16.

Specifically for SPI, in this mode the “Top-Block Swap” behavior is as described below. When the Top Swap Enable bit is 0, the PCH will not invert any address bit.

Table 9-5. SPI Mode Address Swapping

BOOT_BLOCK_SIZE Value	Accesses to	Being Directed to
000 (64 KB)	FFFF_0000h–FFFF_FFFFh	FFFE_0000h–FFFE_FFFFh and vice versa
001 (128 KB)	FFFE_0000h–FFFF_FFFFh	FFFC_0000h–FFFD_FFFFh and vice versa
010 (256 KB)	FFFC_0000h–FFFF_FFFFh	FFF8_0000h–FFFB_FFFFh and vice versa
011 (512 KB)	FFF8_0000h–FFFF_FFFFh	FFF0_0000h–FFF7_FFFFh and vice versa
100 (1 MB)	FFF0_0000h–FFFF_FFFFh	FFE0_0000h–FFEF_FFFFh and vice versa
101–111	Reserved	Reserved



This bit is automatically set to 0 by RTCRST#, but not by PLTRST#.

The scheme is based on the concept that the top block is reserved as the “boot” block, and the block immediately below the top block is reserved for doing boot-block updates.

The algorithm is:

1. Software copies the top block to the block immediately below the top
2. Software checks that the copied block is correct. This could be done by performing a checksum calculation.
3. Software sets the Top Swap bit. This will invert the appropriate address bits for the cycles going to the FWH or SPI.
4. Software erases the top block
5. Software writes the new top block
6. Software checks the new top block
7. Software clears the Top Swap bit

If a power failure occurs at any point after step 3, the system will be able to boot from the copy of the boot block that is stored in the block below the top. This is because the Top Swap bit is backed in the RTC well.

Note: The top-block swap mode may be forced by an external strapping option (See [Section 2.27](#)). When top-block swap mode is forced in this manner, the Top Swap bit cannot be cleared by software. A re-boot with the strap removed will be required to exit a forced top-block swap mode.

Note: Top-block swap mode only affects accesses to the Firmware Hub space, not feature space for FWH.

Note: The top-block swap mode has no effect on accesses below FFFE_0000h for FWH.





10 Chipset Configuration Registers

This section describes all registers and base functionality that is related to chipset configuration and not a specific interface (such as LPC, USB, or PCI Express*). It contains the root complex register block that describes the behavior of the upstream internal link.

This block is mapped into memory space, using the Root Complex Base Address (RCBA) register of the PCI-to-LPC bridge. Accesses in this space must be limited to 32 bit (DW) quantities. Burst accesses are not allowed.

All Chipset Configuration Registers are located in the core well unless otherwise indicated.

10.1 Chipset Configuration Registers (Memory Space)

Note: Address locations that are not shown should be treated as Reserved (see [Section 9.2](#) for details).

Table 10-1. Chipset Configuration Register Memory Map (Memory Space) (Sheet 1 of 2)

Offset	Mnemonic	Register Name	Default	Attribute
0050h–0053h	CIR0	Chipset Initialization Register 0	00000000h	R/WL
0400h–0403h	RPC	Root Port Configuration	0000000yh	R/W, RO
0404h–0407h	RPFN	Root Port Function Number and Hide for PCI Express Root Ports	76543210h	R/WO, RO
0408h–040Bh	FLRSTAT	Function Level Reset Pending Status Summary	00000000h	RO
1E00h–1E03h	TRSR	Trap Status Register	00000000h	R/WC, RO
1E10h–1E17h	TRCR	Trapped Cycle Register	0000000000000000h	RO
1E18h–1E1Fh	TWDR	Trapped Write Data Register	0000000000000000h	RO
1E80h–1E87h	IOTR0	I/O Trap Register 0	0000000000000000h	R/W
1E88h–1E8Fh	IOTR1	I/O Trap Register 1	0000000000000000h	R/W
1E90h–1E97h	IOTR2	I/O Trap Register 2	0000000000000000h	R/W
1E98h–1E9Fh	IOTR3	I/O Trap Register 3	0000000000000000h	R/W
2014h–2017h	V0CTL	Virtual Channel 0 Resource Control	80000011h	R/WL, RO
201Ah–201Bh	V0STS	Virtual Channel 0 Resource Status	0000h	RO
2020h–2023h	V1CTL	Virtual Channel 1 Resource Control	00000000h	R/W, RO, R/WL
2026h–2027h	V1STS	Virtual Channel 1 Resource Status	0000h	RO
20ACh–20AFh	REC	Root Error Command	0000h	R/W
21A4h–21A7h	LCAP	Link Capabilities	00012C42h	RO, R/WO
21A8h–21A9h	LCTL	Link Control	0000h	R/W
21AAh–21ABh	LSTS	Link Status	0042h	RO
21B0h–21B1h	DLCTL2	DMI Link Control 2 Register	0001h	R/W, RO



Table 10-1. Chipset Configuration Register Memory Map (Memory Space) (Sheet 2 of 2)

Offset	Mnemonic	Register Name	Default	Attribute
2234h–2327h	DMIC	DMI Control	00000000h	R/W, RO
3000h–3000h	TCTL	TCO Configuration	00h	R/W
3100h–3103h	D31IP	Device 31 Interrupt Pin	03243200h	R/W, RO
3104h–3107h	D30IP	Device 30 Interrupt Pin	00000000h	RO
3108h–310Bh	D29IP	Device 29 Interrupt Pin	10004321h	R/W
310Ch–310Fh	D28IP	Device 28 Interrupt Pin	00214321h	R/W
3110h–3113h	D27IP	Device 27 Interrupt Pin	00000001h	R/W
3114h–3117h	D26IP	Device 26 Interrupt Pin	30000321h	R/W
3118h–311Bh	D25IP	Device 25 Interrupt Pin	00000001h	R/W
3124h–3127h	D22IP	Device 22 Interrupt Pin	00000001h	R/W
3140h–3141h	D31IR	Device 31 Interrupt Route	3210h	R/W
3144h–3145h	D29IR	Device 29 Interrupt Route	3210h	R/W
3146h–3147h	D28IR	Device 28 Interrupt Route	3210h	R/W
3148h–3149h	D27IR	Device 27 Interrupt Route	3210h	R/W
314Ch–314Dh	D26IR	Device 26 Interrupt Route	3210h	R/W
3150h–3151h	D25IR	Device 25 Interrupt Route	3210h	R/W
315Ch–315Dh	D22IR	Device 22 Interrupt Route	3210h	R/W
31FEh–31FFh	OIC	Other Interrupt Control	0000h	R/W
3310h–3313h	PRSTS	Power and Reset Status	03000000h	RO, R/WC
3318h–331Bh	PM_CFG	Power Management Configuration	00000000h	R/W
332Ch–332Fh	DEEP_S4_POL	Deep S4/S5 From S4 Power Policies	00000000h	R/W
3330h–3333h	DEEP_S5_POL	Deep S4/S5 From S5 Power Policies	00000000h	R/W
33C8h–33CBh	PMSYNC_CFG	PMSYNC Configuration	00000000h	R/W
3400h–3403h	RC	RTC Configuration	00000000h	R/W, R/WLO
3404h–3407h	HPTC	High Precision Timer Configuration	00000000h	R/W
3410h–3413h	GCS	General Control and Status	000000yy0h	R/W, R/WLO
3414h–3414h	BUC	Backed Up Control	00h	R/W
3418h–341Bh	FD	Function Disable	00000000h	R/W
341Ch–341Fh	CG	Clock Gating	00000000h	R/W
3420h–3420h	FDSW	Function Disable SUS Well	00h	R/W
3424h–3425h	DISPBDF	Display Bus, Device and Function Initialization	0010h	R/W
3428h–342Bh	FD2	Function Disable 2	00000000h	R/W
3590h–3594h	MISCCTL	Miscellaneous Control Register	00000000h	R/W
35A0h–35A3h	USBOCM1	USB Overcurrent MAP Register 1	00000000h	R/WO
35A4h–35A7h	USBOCM2	USB Overcurrent MAP Register 2	00000000h	R/WO
35B0h–35B3h	RMHWKCTL	USB Rate Matching Hub Wake Control	00000000h	R/WO



10.1.1 CIR0—Chipset Initialization Register 0

Offset Address: 0050–0053h Attribute: R/WL
 Default Value: 00000000h Size: 32-bit

Bit	Description
31	TC Lock-Down (TCLOCKDN) — R/WL. When set to 1, certain DMI configuration registers are locked down by this and cannot be written. Once set to 1, this bit can only be cleared by a PLTRST#.
30:0	CIR0 Field 0 — R/WL. BIOS must set this field. Bits locked by TCLOCKDN.

10.1.2 RPC—Root Port Configuration Register

Offset Address: 0400–0403h Attribute: R/W, RO
 Default Value: 0000000yh (y = 00xxb) Size: 32-bit

Bit	Description
31:12	Reserved
11	GbE Over PCIe Root Port Enable (GBEPCIERPEN) — R/W. 0 = GbE MAC/PHY communication is not enabled over PCI Express. 1 = The PCI Express port selected by the GBEPCIEPORTSEL register will be used for GbE MAC/PHY over PCI Express communication The default value for this register is set by the GBE_PCIE_EN soft strap. Note: GbE and PCIe will use the output of this register and not the soft strap
10:8	GbE Over PCIe Root Port Select (GBEPCIERPSEL) — R/W. If the GBEPCIERPEN is a '1', then this register determines which port is used for GbE MAC/PHY communication over PCI Express. This register is set by soft strap and is writable to support separate PHY on motherboard and docking station. 111 = Port 8 (Lane 7) 110 = Port 7 (Lane 6) 101 = Port 6 (Lane 5) 100 = Port 5 (Lane 4) 101 = Port 4 (Lane 3) 010 = Port 3 (Lane 2) 001 = Port 2 (Lane 1) 000 = Port 1 (Lane 0) The default value for this register is set by the GBE_PCIEPORTSEL[2:0] soft strap. Note: GbE and PCIe will use the output of this register and not the soft strap
7:4	Reserved
3:2	Port Configuration2 (PC2) — RO. This controls how the PCI bridges are organized in various modes of operation for Ports 5–8. For the following mappings, if a port is not shown, it is considered a x1 port with no connection. This bit is set by the PCIEPCS2[1:0] soft strap. 11 = 1 x4, Port 5 (x4) 10 = 2 x2, Port 5 (x2), Port 7 (x2) 01 = 1x2 and 2x1s, Port 5 (x2), Port 7 (x1) and Port 8(x1) 00 = 4 x1s, Port 5 (x1), Port 6 (x1), Port 7 (x1) and Port 8 (x1)



Bit	Description
1:0	<p>Port Configuration (PC) — RO. This controls how the PCI bridges are organized in various modes of operation for Ports 1–4. For the following mappings, if a port is not shown, it is considered a x1 port with no connection.</p> <p>These bits are set by the PCIEPCS1[1:0] soft strap.</p> <p>11 = 1 x4, Port 1 (x4) 10 = 2 x2, Port 1 (x2), Port 3 (x2) 01 = 1x2 and 2x1s, Port 1 (x2), Port 3 (x1) and Port 4 (x1) 00 = 4 x1s, Port 1 (x1), Port 2 (x1), Port 3 (x1) and Port 4 (x1)</p>

10.1.3 RPFN—Root Port Function Number and Hide for PCI Express* Root Ports Register

Offset Address: 0404–0407h Attribute: R/WO, RO
 Default Value: 76543210h Size: 32-bit

For the PCI Express root ports, the assignment of a function number to a root port is not fixed. BIOS may re-assign the function numbers on a port by port basis. This capability will allow BIOS to disable/hide any root port and still have functions 0 thru N-1 where N is the total number of enabled root ports.

Port numbers will remain fixed to a physical root port.

The existing root port Function Disable registers operate on physical ports (not functions).

Port Configuration (1x4, 4x1, etc.) is not affected by the logical function number assignment and is associated with physical ports.

Bit	Description
31	Root Port 8 Config Hide (RP8CH) — R/W. This bit is used to hide the root port and any devices behind it from being discovered by the OS. When set to 1, the root port will not claim any downstream configuration transactions.
30:28	Root Port 8 Function Number (RP8FN) — R/WO. These bits set the function number for PCI Express Root Port 8. This root port function number must be a unique value from the other root port function numbers
27	Root Port 7 Config Hide (RP7CH) — R/W. This bit is used to hide the root port and any devices behind it from being discovered by the OS. When set to 1, the root port will not claim any downstream configuration transactions.
26:24	Root Port 7 Function Number (RP7FN) — R/WO. These bits set the function number for PCI Express Root Port 7. This root port function number must be a unique value from the other root port function numbers
23	Root Port 6 Config Hide (RP6CH) — R/W. This bit is used to hide the root port and any devices behind it from being discovered by the OS. When set to 1, the root port will not claim any downstream configuration transactions.
22:20	Root Port 6 Function Number (RP6FN) — R/WO. These bits set the function number for PCI Express Root Port 6. This root port function number must be a unique value from the other root port function numbers
19	Root Port 5 Config Hide (RP5CH) — R/W. This bit is used to hide the root port and any devices behind it from being discovered by the OS. When set to 1, the root port will not claim any downstream configuration transactions.



Bit	Description
18:16	Root Port 5 Function Number (RP5FN) — R/WO. These bits set the function number for PCI Express Root Port 5. This root port function number must be a unique value from the other root port function numbers
15	Root Port 4 Config Hide (RP4CH) — R/W. This bit is used to hide the root port and any devices behind it from being discovered by the OS. When set to 1, the root port will not claim any downstream configuration transactions.
14:12	Root Port 4 Function Number (RP4FN) — R/WO. These bits set the function number for PCI Express Root Port 4. This root port function number must be a unique value from the other root port function numbers
11	Root Port 3 Config Hide (RP3CH) — R/W. This bit is used to hide the root port and any devices behind it from being discovered by the OS. When set to 1, the root port will not claim any downstream configuration transactions.
10:8	Root Port 3 Function Number (RP3FN) — R/WO. These bits set the function number for PCI Express Root Port 3. This root port function number must be a unique value from the other root port function numbers
7	Root Port 2 Config Hide (RP2CH) — R/W. This bit is used to hide the root port and any devices behind it from being discovered by the OS. When set to 1, the root port will not claim any downstream configuration transactions.
6:4	Root Port 2 Function Number (RP2FN) — R/WO. These bits set the function number for PCI Express Root Port 2. This root port function number must be a unique value from the other root port function numbers
3	Root Port 1 Config Hide (RP1CH) — R/W. This bit is used to hide the root port and any devices behind it from being discovered by the OS. When set to 1, the root port will not claim any downstream configuration transactions.
2:0	Root Port 1 Function Number (RP1FN) — R/WO. These bits set the function number for PCI Express Root Port 1. This root port function number must be a unique value from the other root port function numbers

10.1.4 FLRSTAT—Function Level Reset Pending Status Register

Offset Address: 0408–040Bh
 Default Value: 00000000h

Attribute: RO
 Size: 32-bit

Bit	Description
31:17	Reserved
16	FLR Pending Status for D29:F0, EHCI #1 — RO. 0 = Function Level Reset is not pending. 1 = Function Level Reset is pending.
15	FLR Pending Status for D26:F0, EHCI #2 — RO. 0 = Function Level Reset is not pending. 1 = Function Level Reset is pending.
10:9	Reserved
8	FLR Pending Status for D26:F0, EHCI#2 — RO. 0 = Function Level Reset is not pending. 1 = Function Level Reset is pending.
7:0	Reserved



10.1.5 TRSR—Trap Status Register

Offset Address: 1E00–1E03h
 Default Value: 00000000h

Attribute: R/WC, RO
 Size: 32-bit

Bit	Description
31:4	Reserved
3:0	<p>Cycle Trap SMI# Status (CTSS) — R/WC. These bits are set by hardware when the corresponding Cycle Trap register is enabled and a matching cycle is received (and trapped). These bits are OR'ed together to create a single status bit in the Power Management register space.</p> <p>Note that the SMI# and trapping must be enabled in order to set these bits. These bits are set before the completion is generated for the trapped cycle, thereby ensuring that the processor can enter the SMI# handler when the instruction completes. Each status bit is cleared by writing a 1 to the corresponding bit location in this register.</p>

10.1.6 TRCR—Trapped Cycle Register

Offset Address: 1E10–1E17h
 Default Value: 0000000000000000h

Attribute: RO
 Size: 64-bit

This register saves information about the I/O Cycle that was trapped and generated the SMI# for software to read.

Bit	Description
63:25	Reserved
24	<p>Read/Write# (RWI) — RO. 0 = Trapped cycle was a write cycle. 1 = Trapped cycle was a read cycle.</p>
23:20	Reserved
19:16	<p>Active-high Byte Enables (AHBE) — RO. This is the DWord-aligned byte enables associated with the trapped cycle. A 1 in any bit location indicates that the corresponding byte is enabled in the cycle.</p>
15:2	<p>Trapped I/O Address (TIOA) — RO. This is the DWord-aligned address of the trapped cycle.</p>
1:0	Reserved



10.1.7 TWDR—Trapped Write Data Register

Offset Address: 1E18–1E1Fh Attribute: RO
 Default Value: 0000000000000000h Size: 64-bit

This register saves the data from I/O write cycles that are trapped for software to read.

Bit	Description
63:32	Reserved
31:0	Trapped I/O Data (TIOD) — RO. DWord of I/O write data. This field is undefined after trapping a read cycle.

10.1.8 IOTRn—I/O Trap Register (0–3)

Offset Address: 1E80–1E87h Register 0 Attribute: R/W
 1E88–1E8Fh Register 1
 1E90–1E97h Register 2
 1E98–1E9Fh Register 3
 Default Value: 0000000000000000h Size: 64-bit

These registers are used to specify the set of I/O cycles to be trapped and to enable this functionality.

Bit	Description
63:50	Reserved
49	Read/Write Mask (RWM) — R/W. 0 = The cycle must match the type specified in bit 48. 1 = Trapping logic will operate on both read and write cycles.
48	Read/Write# (RWIO) — R/W. 0 = Write 1 = Read NOTE: The value in this field does not matter if bit 49 is set.
47:40	Reserved
39:36	Byte Enable Mask (BEM) — R/W. A 1 in any bit position indicates that any value in the corresponding byte enable bit in a received cycle will be treated as a match. The corresponding bit in the Byte Enables field, below, is ignored.
35:32	Byte Enables (TBE) — R/W. Active-high DWord-aligned byte enables.
31:24	Reserved
23:18	Address[7:2] Mask (ADMA) — R/W. A 1 in any bit position indicates that any value in the corresponding address bit in a received cycle will be treated as a match. The corresponding bit in the Address field, below, is ignored. The mask is only provided for the lower 6 bits of the DWord address, allowing for traps on address ranges up to 256 bytes in size.
17:16	Reserved
15:2	I/O Address[15:2] (IOAD) — R/W. DWord-aligned address
1	Reserved
0	Trap and SMI# Enable (TRSE) — R/W. 0 = Trapping and SMI# logic disabled. 1 = The trapping logic specified in this register is enabled.



10.1.9 VOCTL—Virtual Channel 0 Resource Control Register

Offset Address: 2014–2017h Attribute: R/WL, RO
Default Value: 80000011h Size: 32-bit

Bit	Description
31	Virtual Channel Enable (EN) — RO. Always set to 1. VC0 is always enabled and cannot be disabled.
30:27	Reserved
26:24	Virtual Channel Identifier (ID) — RO. Indicates the ID to use for this virtual channel.
23:16	Reserved
15:10	Extended TC/VC Map (ETVM) — R/WL. Defines the upper 8-bits of the VC0 16-bit TC/VC mapping registers. These registers use the PCI Express reserved TC[3] traffic class bit. These bits are locked if the TCLOCKDN bit (RCBA+0050h:bit 31) is set.
9:7	Reserved
6:1	Transaction Class / Virtual Channel Map (TVM) — R/WL. Indicates which transaction classes are mapped to this virtual channel. When a bit is set, this transaction class is mapped to the virtual channel. These bits are locked if the TCLOCKDN bit (RCBA+0050h:bit 31) is set.
0	Reserved

10.1.10 VOSTS—Virtual Channel 0 Resource Status Register

Offset Address: 201A–201Bh Attribute: RO
Default Value: 0000h Size: 16-bit

Bit	Description
15:2	Reserved
1	VC Negotiation Pending (NP) — RO. When set, this bit indicates the virtual channel is still being negotiated with ingress ports.
0	Reserved



10.1.11 V1CTL—Virtual Channel 1 Resource Control Register

Offset Address: 2020–2023h Attribute: R/W, RO, R/WL
 Default Value: 00000000h Size: 32-bit

Bit	Description
31	Virtual Channel Enable (EN) — R/W. Enables the VC when set. Disables the VC when cleared.
30:28	Reserved
27:24	Virtual Channel Identifier (ID) — R/W. Indicates the ID to use for this virtual channel.
23:16	Reserved
15:10	Extended TC/VC Map (ETVM) — R/WL. Defines the upper 8-bits of the VC0 16-bit TC/VC mapping registers. These registers use the PCI Express reserved TC[3] traffic class bit. These bits are locked if the TCLOCKDN bit (RCBA+0050h:bit 31) is set.
9:8	Reserved
7:1	Transaction Class / Virtual Channel Map (TVM) — R/WL. Indicates which transaction classes are mapped to this virtual channel. When a bit is set, this transaction class is mapped to the virtual channel. These bits are locked if the TCLOCKDN bit (RCBA+0050h:bit 31) is set.
0	Reserved

10.1.12 V1STS—Virtual Channel 1 Resource Status Register

Offset Address: 2026–2027h Attribute: RO
 Default Value: 0000h Size: 16-bit

Bit	Description
15:2	Reserved
1	VC Negotiation Pending (NP) — RO. When set, this bit indicates the virtual channel is still being negotiated with ingress ports.
0	Reserved



10.1.13 REC—Root Error Command Register

Offset Address: 20AC–20AFh Attribute: R/W
 Default Value: 0000h Size: 32-bit

Bit	Description
31	Drop Poisoned Downstream Packets (DPDP) — R/W. Determines how downstream packets on DMI are handled that are received with the EP field set, indicating poisoned data: 0 = Packets are forwarded downstream without forcing the UT field set. 1 = This packet and all subsequent packets with data received on DMI for any VC will have their Unsupported Transaction (UT) field set causing them to master Abort downstream. Packets without data such as memory, I/O and config read requests are allowed to proceed.
30:0	Reserved

10.1.14 LCAP—Link Capabilities Register

Offset Address: 21A4–21A7h Attribute: R/WO, RO
 Default Value: 00012C42h Size: 32-bit

Bit	Description
31:18	Reserved
17:15	L1 Exit Latency (EL1) — R/WO. Indicates that the exit latency is 2 μ s to 4 μ s.
14:12	L0s Exit Latency (EL0) — R/W. This field indicates that exit latency is 128 ns to less than 256 ns.
11:10	Active State Link PM Support (APMS) —R/W. Indicates the level of ASPM support on DMI. 00 = Disabled 01 = L0s entry supported 10 = Reserved 11 = L0s and L1 entry supported
9:4	Maximum Link Width (MLW) — RO. Indicates the maximum link width is 4 ports.
3:0	Maximum Link Speed (MLS) — RO. Indicates the link speed is 5.0 Gb/s.



10.1.15 LCTL—Link Control Register

Offset Address: 21A8–21A9h Attribute: R/W
 Default Value: 0000h Size: 16-bit

Bit	Description
15:8	Reserved
7	Extended Synch (ES) — R/W. When set, forces extended transmission of FTS ordered sets when exiting L0s prior to entering L0 and extra TS1 sequences at exit from L1 prior to entering L0.
6:2	Reserved
1:0	Active State Link PM Control (ASPM) — R/W. Indicates whether DMI should enter L0s, L1, or both. 00 = Disabled 01 = L0s entry enabled 10 = L1 entry enabled 11 = L0s and L1 entry enabled

10.1.16 LSTS—Link Status Register

Offset Address: 21AA–21ABh Attribute: RO
 Default Value: 0042h Size: 16-bit

Bit	Description
15:10	Reserved
9:4	Negotiated Link Width (NLW) — RO. Negotiated link width is x4 (000100b).
3:0	Current Link Speed (LS) — RO. 0001b = 2.5 Gb/s 0010b = 5.0 Gb/s

10.1.17 DLCTL2—DMI Link Control 2 Register

Offset Address: 21B0–21B1h Attribute: R/W, RO
 Default Value: 0001h Size: 16-bit

Bit	Description
31:4	Reserved
3:0	DLCTL2 Field 1 — R/W. BIOS must set these bits.



10.1.18 DMIC—DMI Control Register

Offset Address: 2234–2237h
Default Value: 00000000h

Attribute: R/W
Size: 32-bit

Bit	Description
31:2	Reserved
1:0	DMI Clock Gate Enable (DMICGEN) — R/W. BIOS must program this field to 11b.

10.1.19 TCTL—TCO Configuration Register

Offset Address: 3000–3000h
Default Value: 00h

Attribute: R/W
Size: 8-bit

Bit	Description
7	TCO IRQ Enable (IE) — R/W. 0 = TCO IRQ is disabled. 1 = TCO IRQ is enabled, as selected by the TCO_IRQ_SEL field.
6:3	Reserved
2:0	TCO IRQ Select (IS) — R/W. Specifies on which IRQ the TCO will internally appear. If not using the APIC, the TCO interrupt must be routed to IRQ9–11, and that interrupt is not sharable with the SERIRQ stream, but is shareable with other PCI interrupts. If using the APIC, the TCO interrupt can also be mapped to IRQ20–23, and can be shared with other interrupt. 000 = IRQ 9 001 = IRQ 10 010 = IRQ 11 011 = Reserved 100 = IRQ 20 (only if APIC enabled) 101 = IRQ 21 (only if APIC enabled) 110 = IRQ 22 (only if APIC enabled) 111 = IRQ 23 (only if APIC enabled) When setting the these bits, the IE bit should be cleared to prevent glitching. When the interrupt is mapped to APIC interrupts 9, 10, or 11, the APIC should be programmed for active-high reception. When the interrupt is mapped to APIC interrupts 20 through 23, the APIC should be programmed for active-low reception.



10.1.20 D31IP—Device 31 Interrupt Pin Register

Offset Address: 3100–3103h
 Default Value: 03243200h

Attribute: R/W, RO
 Size: 32-bit

Bit	Description
31:28	Reserved
27:24	Thermal Throttle Pin (TTIP) — R/W. Indicates which pin the Thermal Throttle controller drives as its interrupt 0h = No interrupt 1h = INTA# 2h = INTB# (Default) 3h = INTC# 4h = INTD# 5h–Fh = Reserved
23:20	SATA Pin 2 (SIP2) — R/W. Indicates which pin the SATA controller 2 drives as its interrupt. 0h = No interrupt 1h = INTA# 2h = INTB# (Default) 3h = INTC# 4h = INTD# 5h–Fh = Reserved
19:16	Reserved
15:12	SMBus Pin (SMIP) — R/W. Indicates which pin the SMBus controller drives as its interrupt. 0h = No interrupt 1h = INTA# 2h = INTB# (Default) 3h = INTC# 4h = INTD# 5h–Fh = Reserved
11:8	SATA Pin (SIP) — R/W. Indicates which pin the SATA controller drives as its interrupt. 0h = No interrupt 1h = INTA# 2h = INTB# (Default) 3h = INTC# 4h = INTD# 5h–Fh = Reserved
7:4	Reserved
3:0	LPC Bridge Pin (LIP) — RO. Currently, the LPC bridge does not generate an interrupt, so this field is read-only and 0.



10.1.21 D30IP—Device 30 Interrupt Pin Register

Offset Address: 3104–3107h Attribute: RO
Default Value: 00000000h Size: 32-bit

Bit	Description
31:4	Reserved
3:0	PCI Bridge Pin (PIP) — RO. Currently, the PCI bridge does not generate an interrupt, so this field is read-only and 0.

10.1.22 D29IP—Device 29 Interrupt Pin Register

Offset Address: 3108–310Bh Attribute: R/W
Default Value: 10004321h Size: 32-bit

Bit	Description
31:4	Reserved
3:0	EHCI #1 Pin (E1P) — R/W. Indicates which pin the EHCI controller #1 drives as its interrupt, if controller exists. 0h = No interrupt 1h = INTA# (Default) 2h = INTB# 3h = INTC# 4h = INTD# 5h–7h = Reserved NOTE: EHCI Controller #1 is mapped to Device 29 Function 0.

10.1.23 D28IP—Device 28 Interrupt Pin Register

Offset Address: 310C–310Fh Attribute: R/W
Default Value: 00214321h Size: 32-bit

Bit	Description
31:28	PCI Express* #8 Pin (P8IP) — R/W. Indicates which pin the PCI Express* port #8 drives as its interrupt. 0h = No interrupt 1h = INTA# 2h = INTB# (Default) 3h = INTC# 4h = INTD# 5h–7h = Reserved
27:24	PCI Express #7 Pin (P7IP) — R/W. Indicates which pin the PCI Express port #7 drives as its interrupt. 0h = No interrupt 1h = INTA# (Default) 2h = INTB# 3h = INTC# 4h = INTD# 5h–7h = Reserved



Bit	Description
23:20	PCI Express* #6 Pin (P6IP) — R/W. Indicates which pin the PCI Express* port #6 drives as its interrupt. 0h = No interrupt 1h = INTA# 2h = INTB# (Default) 3h = INTC# 4h = INTD# 5h–7h = Reserved
19:16	PCI Express #5 Pin (P5IP) — R/W. Indicates which pin the PCI Express port #5 drives as its interrupt. 0h = No interrupt 1h = INTA# (Default) 2h = INTB# 3h = INTC# 4h = INTD# 5h–7h = Reserved
15:12	PCI Express #4 Pin (P4IP) — R/W. Indicates which pin the PCI Express* port #4 drives as its interrupt. 0h = No interrupt 1h = INTA# 2h = INTB# 3h = INTC# 4h = INTD# (Default) 5h–7h = Reserved
11:8	PCI Express #3 Pin (P3IP) — R/W. Indicates which pin the PCI Express port #3 drives as its interrupt. 0h = No interrupt 1h = INTA# 2h = INTB# 3h = INTC# (Default) 4h = INTD# 5h–7h = Reserved
7:4	PCI Express #2 Pin (P2IP) — R/W. Indicates which pin the PCI Express port #2 drives as its interrupt. 0h = No interrupt 1h = INTA# 2h = INTB# (Default) 3h = INTC# 4h = INTD# 5h–7h = Reserved
3:0	PCI Express #1 Pin (P1IP) — R/W. Indicates which pin the PCI Express port #1 drives as its interrupt. 0h = No interrupt 1h = INTA# (Default) 2h = INTB# 3h = INTC# 4h = INTD# 5h–7h = Reserved



10.1.24 D27IP—Device 27 Interrupt Pin Register

Offset Address: 3110–3113h Attribute: R/W
Default Value: 00000001h Size: 32-bit

Bit	Description
31:4	Reserved
3:0	Intel® High Definition Audio Pin (ZIP) — R/W. Indicates which pin the Intel® High Definition Audio controller drives as its interrupt. 0h = No interrupt 1h = INTA# (Default) 2h = INTB# 3h = INTC# 4h = INTD# 5h–Fh = Reserved

10.1.25 D26IP—Device 26 Interrupt Pin Register

Offset Address: 3114–3117h Attribute: R/W
Default Value: 30000321h Size: 32-bit

Bit	Description
31:4	Reserved
3:0	EHCI #2 Pin (E2P) — R/W. Indicates which pin EHCI controller #2 drives as its interrupt, if controller exists. 0h = No Interrupt 1h = INTA# (Default) 2h = INTB# 3h = INTC# 4h = INTD# 5h–Fh = Reserve NOTE: EHCI Controller #2 is mapped to Device 26 Function 0.

10.1.26 D25IP—Device 25 Interrupt Pin Register

Offset Address: 3118–311Bh Attribute: R/W
Default Value: 00000001h Size: 32-bit

Bit	Description
31:4	Reserved
3:0	GbE LAN Pin (LIP) — R/W. Indicates which pin the internal GbE LAN controller drives as its interrupt 0h = No Interrupt 1h = INTA# (Default) 2h = INTB# 3h = INTC# 4h = INTD# 5h–Fh = Reserved



10.1.27 D22IP—Device 22 Interrupt Pin Register

Offset Address: 3124–3127h
 Default Value: 00000001h

Attribute: R/W
 Size: 32-bit

Bit	Description
31:16	Reserved
15:12	KT Pin (KTIP) — R/W. Indicates which pin the Keyboard text PCI functionality drives as its interrupt 0h = No Interrupt 1h = INTA# 2h = INTB# 3h = INTC# 4h = INTD# 5h–Fh = Reserved
11:8	IDE-R Pin (IDERIP) — R/W. Indicates which pin the IDE Redirect PCI functionality drives as its interrupt 0h = No Interrupt 1h = INTA# 2h = INTB# 3h = INTC# 4h = INTD# 5h–Fh = Reserved
7:4	Intel® MEI #2 Pin (MEI2IP) — R/W. Indicates which pin the Management Engine Interface #2 drives as its interrupt 0h = No Interrupt 1h = INTA# 2h = INTB# 3h = INTC# 4h = INTD# 5h–Fh = Reserved
3:0	Intel® MEI #1 Pin (MEI1IP) — R/W. Indicates which pin the Management Engine Interface controller #1 drives as its interrupt 0h = No Interrupt 1h = INTA# 2h = INTB# 3h = INTC# 4h = INTD# 5h–Fh = Reserved



10.1.28 D31IR—Device 31 Interrupt Route Register

Offset Address: 3140–3141h Attribute: R/W
 Default Value: 3210h Size: 16-bit

Bit	Description
15	Reserved
14:12	Interrupt D Pin Route (IDR) — R/W. Indicates which physical pin on the PCH is connected to the INTD# pin reported for device 31 functions. 0h = PIRQA# 1h = PIRQB# 2h = PIRQC# 3h = PIRQD# (Default) 4h = PIRQE# 5h = PIRQF# 6h = PIRQG# 7h = PIRQH#
11	Reserved
10:8	Interrupt C Pin Route (ICR) — R/W. Indicates which physical pin on the PCH is connected to the INTC# pin reported for device 31 functions. 0h = PIRQA# 1h = PIRQB# 2h = PIRQC# (Default) 3h = PIRQD# 4h = PIRQE# 5h = PIRQF# 6h = PIRQG# 7h = PIRQH#
7	Reserved
6:4	Interrupt B Pin Route (IBR) — R/W. Indicates which physical pin on the PCH is connected to the INTB# pin reported for device 31 functions. 0h = PIRQA# 1h = PIRQB# (Default) 2h = PIRQC# 3h = PIRQD# 4h = PIRQE# 5h = PIRQF# 6h = PIRQG# 7h = PIRQH#
3	Reserved
2:0	Interrupt A Pin Route (IAR) — R/W. Indicates which physical pin on the PCH is connected to the INTA# pin reported for device 31 functions. 0h = PIRQA# (Default) 1h = PIRQB# 2h = PIRQC# 3h = PIRQD# 4h = PIRQE# 5h = PIRQF# 6h = PIRQG# 7h = PIRQH#



10.1.29 D29IR—Device 29 Interrupt Route Register

Offset Address: 3144–3145h
 Default Value: 3210h

Attribute: R/W
 Size: 16-bit

Bit	Description
15	Reserved
14:12	<p>Interrupt D Pin Route (IDR) — R/W. Indicates which physical pin on the PCH is connected to the INTD# pin reported for device 29 functions.</p> <p>0h = PIRQA# 1h = PIRQB# 2h = PIRQC# 3h = PIRQD# (Default) 4h = PIRQE# 5h = PIRQF# 6h = PIRQG# 7h = PIRQH#</p>
11	Reserved
10:8	<p>Interrupt C Pin Route (ICR) — R/W. Indicates which physical pin on the PCH is connected to the INTC# pin reported for device 29 functions.</p> <p>0h = PIRQA# 1h = PIRQB# 2h = PIRQC# (Default) 3h = PIRQD# 4h = PIRQE# 5h = PIRQF# 6h = PIRQG# 7h = PIRQH#</p>
7	Reserved
6:4	<p>Interrupt B Pin Route (IBR) — R/W. Indicates which physical pin on the PCH is connected to the INTB# pin reported for device 29 functions.</p> <p>0h = PIRQA# 1h = PIRQB# (Default) 2h = PIRQC# 3h = PIRQD# 4h = PIRQE# 5h = PIRQF# 6h = PIRQG# 7h = PIRQH#</p>
3	Reserved
2:0	<p>Interrupt A Pin Route (IAR) — R/W. Indicates which physical pin on the PCH is connected to the INTA# pin reported for device 29 functions.</p> <p>0h = PIRQA# (Default) 1h = PIRQB# 2h = PIRQC# 3h = PIRQD# 4h = PIRQE# 5h = PIRQF# 6h = PIRQG# 7h = PIRQH#</p>



10.1.30 D28IR—Device 28 Interrupt Route Register

Offset Address: 3146–3147h
Default Value: 3210h

Attribute: R/W
Size: 16-bit

Bit	Description
15	Reserved
14:12	Interrupt D Pin Route (IDR) — R/W. Indicates which physical pin on the PCH is connected to the INTD# pin reported for device 28 functions. 0h = PIRQA# 1h = PIRQB# 2h = PIRQC# 3h = PIRQD# (Default) 4h = PIRQE# 5h = PIRQF# 6h = PIRQG# 7h = PIRQH#
11	Reserved
10:8	Interrupt C Pin Route (ICR) — R/W. Indicates which physical pin on the PCH is connected to the INTC# pin reported for device 28 functions. 0h = PIRQA# 1h = PIRQB# 2h = PIRQC# (Default) 3h = PIRQD# 4h = PIRQE# 5h = PIRQF# 6h = PIRQG# 7h = PIRQH#
7	Reserved
6:4	Interrupt B Pin Route (IBR) — R/W. Indicates which physical pin on the PCH is connected to the INTB# pin reported for device 28 functions. 0h = PIRQA# 1h = PIRQB# (Default) 2h = PIRQC# 3h = PIRQD# 4h = PIRQE# 5h = PIRQF# 6h = PIRQG# 7h = PIRQH#
3	Reserved
2:0	Interrupt A Pin Route (IAR) — R/W. Indicates which physical pin on the PCH is connected to the INTA# pin reported for device 28 functions. 0h = PIRQA# (Default) 1h = PIRQB# 2h = PIRQC# 3h = PIRQD# 4h = PIRQE# 5h = PIRQF# 6h = PIRQG# 7h = PIRQH#



10.1.31 D27IR—Device 27 Interrupt Route Register

Offset Address: 3148–3149h
 Default Value: 3210h

Attribute: R/W
 Size: 16-bit

Bit	Description
15	Reserved
14:12	<p>Interrupt D Pin Route (IDR) — R/W. Indicates which physical pin on the PCH is connected to the INTD# pin reported for device 27 functions.</p> <p>0h = PIRQA# 1h = PIRQB# 2h = PIRQC# 3h = PIRQD# (Default) 4h = PIRQE# 5h = PIRQF# 6h = PIRQG# 7h = PIRQH#</p>
11	Reserved
10:8	<p>Interrupt C Pin Route (ICR) — R/W. Indicates which physical pin on the PCH is connected to the INTC# pin reported for device 27 functions.</p> <p>0h = PIRQA# 1h = PIRQB# 2h = PIRQC# (Default) 3h = PIRQD# 4h = PIRQE# 5h = PIRQF# 6h = PIRQG# 7h = PIRQH#</p>
7	Reserved
6:4	<p>Interrupt B Pin Route (IBR) — R/W. Indicates which physical pin on the PCH is connected to the INTB# pin reported for device 27 functions.</p> <p>0h = PIRQA# 1h = PIRQB# (Default) 2h = PIRQC# 3h = PIRQD# 4h = PIRQE# 5h = PIRQF# 6h = PIRQG# 7h = PIRQH#</p>
3	Reserved
2:0	<p>Interrupt A Pin Route (IAR) — R/W. Indicates which physical pin on the PCH is connected to the INTA# pin reported for device 27 functions.</p> <p>0h = PIRQA# (Default) 1h = PIRQB# 2h = PIRQC# 3h = PIRQD# 4h = PIRQE# 5h = PIRQF# 6h = PIRQG# 7h = PIRQH#</p>



10.1.32 D26IR—Device 26 Interrupt Route Register

Offset Address: 314C–314Dh
Default Value: 3210h

Attribute: R/W
Size: 16-bit

Bit	Description
15	Reserved
14:12	Interrupt D Pin Route (IDR) — R/W. Indicates which physical pin on the PCH is connected to the INTD# pin reported for device 26 functions: 0h = PIRQA# 1h = PIRQB# 2h = PIRQC# 3h = PIRQD# (Default) 4h = PIRQE# 5h = PIRQF# 6h = PIRQG# 7h = PIRQH#
11	Reserved
10:8	Interrupt C Pin Route (ICR) — R/W. Indicates which physical pin on the PCH is connected to the INTC# pin reported for device 26 functions. 0h = PIRQA# 1h = PIRQB# 2h = PIRQC# (Default) 3h = PIRQD# 4h = PIRQE# 5h = PIRQF# 6h = PIRQG# 7h = PIRQH#
7	Reserved
6:4	Interrupt B Pin Route (IBR) — R/W. Indicates which physical pin on the PCH is connected to the INTB# pin reported for device 26 functions. 0h = PIRQA# 1h = PIRQB# (Default) 2h = PIRQC# 3h = PIRQD# 4h = PIRQE# 5h = PIRQF# 6h = PIRQG# 7h = PIRQH#
3	Reserved
2:0	Interrupt A Pin Route (IAR) — R/W. Indicates which physical pin on the PCH is connected to the INTA# pin reported for device 26 functions. 0h = PIRQA# (Default) 1h = PIRQB# 2h = PIRQC# 3h = PIRQD# 4h = PIRQE# 5h = PIRQF# 6h = PIRQG# 7h = PIRQH#



10.1.33 D25IR—Device 25 Interrupt Route Register

Offset Address: 3150–3151h
 Default Value: 3210h

Attribute: R/W
 Size: 16-bit

Bit	Description
15	Reserved
14:12	<p>Interrupt D Pin Route (IDR): — R/W. Indicates which physical pin on the PCH is connected to the INTD# pin reported for device 25 functions:</p> <p>0h = PIRQA# 1h = PIRQB# 2h = PIRQC# 3h = PIRQD# (Default) 4h = PIRQE# 5h = PIRQF# 6h = PIRQG# 7h = PIRQH#</p>
11	Reserved
10:8	<p>Interrupt C Pin Route (ICR) — R/W. Indicates which physical pin on the PCH is connected to the INTC# pin reported for device 25 functions.</p> <p>0h = PIRQA# 1h = PIRQB# 2h = PIRQC# (Default) 3h = PIRQD# 4h = PIRQE# 5h = PIRQF# 6h = PIRQG# 7h = PIRQH#</p>
7	Reserved
6:4	<p>Interrupt B Pin Route (IBR) — R/W. Indicates which physical pin on the PCH is connected to the INTB# pin reported for device 25 functions.</p> <p>0h = PIRQA# 1h = PIRQB# (Default) 2h = PIRQC# 3h = PIRQD# 4h = PIRQE# 5h = PIRQF# 6h = PIRQG# 7h = PIRQH#</p>
3	Reserved
2:0	<p>Interrupt A Pin Route (IAR) — R/W. Indicates which physical pin on the PCH is connected to the INTA# pin reported for device 25 functions.</p> <p>0h = PIRQA# (Default) 1h = PIRQB# 2h = PIRQC# 3h = PIRQD# 4h = PIRQE# 5h = PIRQF# 6h = PIRQG# 7h = PIRQH#</p>

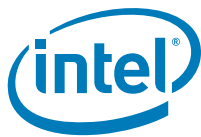

10.1.34 D22IR—Device 22 Interrupt Route Register

Offset Address: 315C–315Dh
 Default Value: 3210h

Attribute: R/W
 Size: 16-bit

Bit	Description
15	Reserved
14:12	<p>Interrupt D Pin Route (IDR): — R/W. Indicates which physical pin on the PCH is connected to the INTD# pin reported for device 22 functions:</p> <p>0h = PIRQA# 1h = PIRQB# 2h = PIRQC# 3h = PIRQD# (Default) 4h = PIRQE# 5h = PIRQF# 6h = PIRQG# 7h = PIRQH#</p>
11	Reserved
10:8	<p>Interrupt C Pin Route (ICR) — R/W. Indicates which physical pin on the PCH is connected to the INTC# pin reported for device 22 functions.</p> <p>0h = PIRQA# 1h = PIRQB# 2h = PIRQC# (Default) 3h = PIRQD# 4h = PIRQE# 5h = PIRQF# 6h = PIRQG# 7h = PIRQH#</p>
7	Reserved
6:4	<p>Interrupt B Pin Route (IBR) — R/W. Indicates which physical pin on the PCH is connected to the INTB# pin reported for device 22 functions.</p> <p>0h = PIRQA# 1h = PIRQB# (Default) 2h = PIRQC# 3h = PIRQD# 4h = PIRQE# 5h = PIRQF# 6h = PIRQG# 7h = PIRQH#</p>
3	Reserved
2:0	<p>Interrupt A Pin Route (IAR) — R/W. Indicates which physical pin on the PCH is connected to the INTA# pin reported for device 22 functions.</p> <p>0h = PIRQA# (Default) 1h = PIRQB# 2h = PIRQC# 3h = PIRQD# 4h = PIRQE# 5h = PIRQF# 6h = PIRQG# 7h = PIRQH#</p>



10.1.35 OIC—Other Interrupt Control Register

Offset Address: 31FE–31FFh
 Default Value: 0000h

Attribute: R/W
 Size: 16-bit

Bit	Description
15:10	Reserved
9	<p>Coprocessor Error Enable (CEN) — R/W.</p> <p>0 = FERR# will not generate IRQ13 nor IGNNE#. 1 = If FERR# is low, the PCH generates IRQ13 internally and holds it until an I/O port F0h write. It will also drive IGNNE# active.</p>
8	<p>APIC Enable (AEN) — R/W.</p> <p>0 = The internal IOxAPIC is disabled. 1 = Enables the internal IOxAPIC and its address decode.</p> <p>NOTE: Software should read this register after modifying APIC enable bit prior to access to the IOxAPIC address range.</p>
7:0	<p>APIC Range Select (ASEL) — R/W. These bits define address bits 19:12 for the IOxAPIC range. The default value of 00h enables compatibility with prior PCH products as an initial value. This value must not be changed unless the IOxAPIC Enable bit is cleared.</p>

NOTE: FEC10000h–FEC3FFFFh is allocated to PCIe when I/OxApic Enable (PAE) bit is set.



10.1.36 PRSTS—Power and Reset Status Register

Offset Address: 3310–3313h
Default Value: 03000000h

Attribute: RO, R/WC
Size: 32-bit

Bit	Description
31:16	Reserved
15	Power Management Watchdog Timer — R/WC. This bit is set when the Power Management watchdog timer causes a global reset.
14:7	Reserved
6	Intel® Management Engine Watchdog Timer Status — R/WC. This bit is set when the Intel Management Engine watchdog timer causes a global reset.
5	Wake On LAN Override Wake Status (WOL_OVR_WK_STS) — R/WC. This bit gets set when all of the following conditions are met: <ul style="list-style-type: none">• Integrated LAN Signals a Power Management Event• The system is not in S0• The "WOL Enable Override" bit is set in configuration space. BIOS can read this status bit to determine this wake source. Software clears this bit by writing a 1 to it.
4	Reserved
3	Intel ME Host Power Down (ME_HOST_PWRDN) — R/WC. This bit is set when the Intel Management Engine generates a host reset with power down.
2	Intel ME Host Reset Warm Status (ME_HRST_WARM_STS) — R/WC. This bit is set when the Intel Management Engine generates a Host reset without power cycling. Software clears this bit by writing a 1 to this bit position.
1	Intel ME Host Reset Cold Status (ME_HRST_COLD_STS) — R/WC. This bit is set when the Intel Management Engine generates a Host reset with power cycling. Software clears this bit by writing a 1 to this bit position.
0	Intel ME WAKE STATUS (ME_WAKE_STS) — R/WC. This bit is set when the Intel Management Engine generates a Non-Maskable wake event, and is not affected by any other enable bit. When this bit is set, the Host Power Management logic wakes to S0.



10.1.37 PM_CFG—Power Management Configuration Register

Offset Address: 3318–331Bh
 Default Value: 0000000h

Attribute: R/W
 Size: 32-bit

Bit	Description
31:27	Reserved
26:24	PM_CFG Field 1 — R/W. BIOS must program this field to 101b.
23:22	Reserved
21	RTC Wake from Deep S4/S5 Disable (RTC_DS_WAKE_DIS) — R/W. When set, this bit disables RTC wakes from waking the system from Deep S4/S5. This bit is reset by RTCRST#.
20	Reserved
19:18	<p>SLP_SUS# Minimum Assertion Width (SLP_SUS_MIN_ASST_WDTH)— R/W. This field indicates the minimum assertion width of the SLP_SUS# signal to guarantee that the SUS power supplies have been fully power cycled. This value may be modified per platform depending on power supply capacitance, board capacitance, power circuits, etc.</p> <p>Valid values are: 11 = 4 seconds 10 = 1 second 01 = 500 ms 00 = 0 ms (that is, stretching disabled - default)</p> <p>These bits are cleared by RTCRST# assertion.</p> <p>NOTES:</p> <ol style="list-style-type: none"> 1. This field is RO when the SLP Stretching Policy Lock-Down bit is set. 2. This field is ignored when exiting G3 or Deep S4/S5 states if the “Disable SLP Stretching After SUS Well Power Up” bit is set. Note that unlike with all other SLP_* pin stretching, this disable bit only impacts SLP_SUS# stretching during G3 exit rather than both G3 and Deep S4/S5 exit. SLP_SUS# stretching always applies to Deep S4/S5 regardless of the disable bit. 3. For platforms that enable Deep S4/S5, BIOS must program SLP_SUS# stretching to be greater than or equal to the largest stretching value on any other SLP_* pin (SLP_S3#, SLP_S4#, or SLP_A#).
17:16	<p>SLP_A# Minimum Assertion Width (SLP_A_MIN_ASST_WDTH) — R/W. This field indicates the minimum assertion width of the SLP_A# signal to guarantee that the ASW power supplies have been fully power cycled. This value may be modified per platform depending on power supply capacitance, board capacitance, power circuits, etc.</p> <p>Valid values are: 11 = 2 seconds 10 = 98 ms 01 = 4 seconds 00 = 0 ms (that is, stretching disabled – default)</p> <p>These bits are cleared by RTCRST# assertion.</p> <p>NOTES:</p> <ol style="list-style-type: none"> 1. This field is RO when the SLP Stretching Policy Lock-Down bit is set. 2. This field is ignored when exiting G3 or Deep S4/S5 states if the “Disable SLP Stretching After SUS Well Power Up” bit is set.
15:0	Reserved



10.1.38 DEEP_S4_POL—Deep S4/S5 From S4 Power Policies Register

Offset Address: 332C–332Fh Attribute: R/W
Default Value: 00000000h Size: 32-bit

This register is in the RTC power well and is reset by RTCRST# assertion.

Bit	Description
31:2	Reserved
1	Deep S4/S5 From S4 Enable in DC Mode (DPS4_EN_DC) — R/W. A '1' in this bit enables the platform to enter Deep S4/S5 while operating in S4 on DC power (based on the AC_PRESENT pin value).
0	Deep S4/S5 From S4 Enable in AC Mode (DPS4_EN_AC) — R/W. A '1' in this bit enables the platform to enter Deep S4/S5 while operating in S4 on AC power (based on the AC_PRESENT pin value). Required to be programmed to 0 on mobile.

10.1.39 DEEP_S5_POL—Deep S4/S5 From S5 Power Policies Register

Offset Address: 3330–3333h Attribute: R/W
Default Value: 00000000h Size: 32-bit

This register is in the RTC power well and is reset by RTCRST# assertion.

Bit	Description
31:16	Reserved
15	Deep S4/S5 From S5 Enable in DC Mode (DPS5_EN_DC) — R/W. A '1' in this bit enables the platform to enter Deep S4/S5 while operating in S5 on DC power (based on the AC_PRESENT pin value).
14	Deep S4/S5 From S5 Enable in AC Mode (DPS5_EN_AC) — R/W. A '1' in this bit enables the platform to enter Deep S4/S5 while operating in S5 on AC power (based on the AC_PRESENT pin value). Required to be programmed to 0 on mobile.
13:0	Reserved



10.1.40 PMSYNC_CFG—PMSYNC Configuration Register

Offset Address: 33C8–33CBh
 Default Value: 00000000h

Attribute: R/W
 Size: 32-bit

Bit	Description
31:12	Reserved
11	GPIO_D Pin Selection (GPIO_D_SEL) — R/W. There are two possible GPIOs that can be routed to the GPIO_D PMSYNC state. This bit selects between them: 0 = GPIO5 (default) 1 = GPIO0
10	GPIO_C Pin Selection (GPIO_C_SEL) — R/W. There are two possible GPIOs that can be routed to the GPIO_C PMSYNC state. This bit selects between them: 0 = GPIO37 (default) 1 = GPIO4
9	GPIO_B Pin Selection (GPIO_B_SEL) — R/W. There are two possible GPIOs that can be routed to the GPIO_B PMSYNC state. This bit selects between them: 0 = GPIO0 (default) 1 = GPIO37
8	GPIO_A Pin Selection (GPIO_A_SEL) — R/W. There are two possible GPIOs that can be routed to the GPIO_A PMSYNC state. This bit selects between them: 0 = GPIO4 (default) 1 = GPIO5
7:0	Reserved



10.1.41 RC—RTC Configuration Register

Offset Address: 3400–3403h
Default Value: 00000000h

Attribute: R/W, R/WLO
Size: 32-bit

Bit	Description
31:5	Reserved
4	Upper 128 Byte Lock (UL) — R/WLO. 0 = Bytes not locked. 1 = Bytes 38h–3Fh in the upper 128-byte bank of RTC RAM are locked and cannot be accessed. Writes will be dropped and reads will not return any ensured data. Bit reset on system reset.
3	Lower 128 Byte Lock (LL) — R/WLO. 0 = Bytes not locked. 1 = Bytes 38h–3Fh in the lower 128-byte bank of RTC RAM are locked and cannot be accessed. Writes will be dropped and reads will not return any ensured data. Bit reset on system reset.
2	Upper 128 Byte Enable (UE) — R/W. 0 = Bytes locked. 1 = The upper 128-byte bank of RTC RAM can be accessed.
1:0	Reserved

10.1.42 HPTC—High Precision Timer Configuration Register

Offset Address: 3404–3407h
Default Value: 00000000h

Attribute: R/W
Size: 32-bit

Bit	Description
31:8	Reserved
7	Address Enable (AE) — R/W. 0 = Address disabled. 1 = The PCH will decode the High Precision Timer memory address range selected by bits 1:0 below.
6:2	Reserved
1:0	Address Select (AS) — R/W. This 2-bit field selects 1 of 4 possible memory address ranges for the High Precision Timer functionality. The encodings are: 00 = FED0_0000h – FED0_03FFh 01 = FED0_1000h – FED0_13FFh 10 = FED0_2000h – FED0_23FFh 11 = FED0_3000h – FED0_33FFh



10.1.43 GCS—General Control and Status Register

Offset Address: 3410–3413h Attribute: R/W, R/WLO
 Default Value: 0000yy0h (yy = xx0000x0b) Size: 32-bit

Bit	Description										
31:13	Reserved										
12	<p>Function Level Reset Capability Structure Select (FLRCSEL) — R/W. 0 = Function Level Reset (FLR) will utilize the standard capability structure with unique capability ID assigned by PCISIG. 1 = Vendor Specific Capability Structure is selected for FLR.</p>										
11:10	<p>Boot BIOS Straps (BBS) — R/W. This field determines the destination of accesses to the BIOS memory range. The default values for these bits represent the strap values of GNT1#/GPIO51 (bit 11) at the rising edge of PWROK and SATA1GP/GPIO19 (bit 10) at the rising edge of PWROK.</p> <table border="1"> <thead> <tr> <th>Bits 11:10</th> <th>Description</th> </tr> </thead> <tbody> <tr> <td>00b</td> <td>LPC</td> </tr> <tr> <td>01b</td> <td>Reserved</td> </tr> <tr> <td>10b</td> <td>PCI</td> </tr> <tr> <td>11b</td> <td>SPI</td> </tr> </tbody> </table> <p>When PCI is selected, the top 16 MB of memory below 4 GB (FF00_0000h to FFFF_FFFFh) is accepted by the primary side of the PCI P2P bridge and forwarded to the PCI bus. This allows systems with corrupted or unprogrammed flash to boot from a PCI device. The PCI-to-PCI bridge Memory Space Enable bit does not need to be set (nor any other bits) in order for these cycles to go to PCI. Note that BIOS decode range bits and the other BIOS protection bits have no effect when PCI is selected. This functionality is intended for debug/testing only.</p> <p>When SPI or LPC is selected, the range that is decoded is further qualified by other configuration bits described in the respective sections.</p> <p>The value in this field can be overwritten by software as long as the BIOS Interface Lock-Down (bit 0) is not set.</p> <p>NOTE: Booting to PCI is intended for debug/testing only. Boot BIOS Destination Select to LPC/PCI by functional strap or using Boot BIOS Destination Bit will not affect SPI accesses initiated by Intel® Management Engine or Integrated GbE LAN.</p>	Bits 11:10	Description	00b	LPC	01b	Reserved	10b	PCI	11b	SPI
Bits 11:10	Description										
00b	LPC										
01b	Reserved										
10b	PCI										
11b	SPI										
9	<p>Server Error Reporting Mode (SERM) — R/W. 0 = The PCH is the final target of all errors. The processor sends a messages to the PCH for the purpose of generating NMI. 1 = The processor is the final target of all errors from PCI Express* and DMI. In this mode, if the PCH detects a fatal, non-fatal, or correctable error on DMI or its downstream ports, it sends a message to the processor. If the PCH receives an ERR_* message from the downstream port, it sends that message to the processor.</p>										
8:6	Reserved										
5	<p>No Reboot (NR) — R/W. This bit is set when the "No Reboot" strap (SPKR pin on the PCH) is sampled high on PWROK. This bit may be set or cleared by software if the strap is sampled low but may not override the strap when it indicates "No Reboot". 0 = System will reboot upon the second timeout of the TCO timer. 1 = The TCO timer will count down and generate the SMI# on the first timeout, but will not reboot on the second timeout.</p>										



Bit	Description
4	Alternate Access Mode Enable (AME) — R/W. 0 = Disabled. 1 = Alternate access read only registers can be written, and write only registers can be read. Before entering a low power state, several registers from powered down parts may need to be saved. In the majority of cases, this is not an issue, as registers have read and write paths. However, several of the ISA compatible registers are either read only or write only. To get data out of write-only registers, and to restore data into read-only registers, the PCH implements an alternate access mode. For a list of these registers see Section 5.13.9 .
3	Shutdown Policy Select (SPS) — R/W. 0 = PCH will drive INIT# in response to the shutdown Vendor Defined Message (VDM). (default) 1 = PCH will treat the shutdown VDM similar to receiving a CF9h I/O write with data value 06h, and will drive PLTRST# active.
2	Reserved Page Route (RPR) — R/W. Determines where to send the reserved page registers. These addresses are sent to PCI or LPC for the purpose of generating POST codes. The I/O addresses modified by this field are: 80h, 84h, 85h, 86h, 88h, 8Ch, 8Dh, and 8Eh. 0 = Writes will be forwarded to LPC, shadowed within the PCH, and reads will be returned from the internal shadow 1 = Writes will be forwarded to PCI, shadowed within the PCH, and reads will be returned from the internal shadow. NOTE: if some writes are done to LPC/PCI to these I/O ranges, and then this bit is flipped, such that writes will now go to the other interface, the reads will not return what was last written. Shadowing is performed on each interface. The aliases for these registers, at 90h, 94h, 95h, 96h, 98h, 9Ch, 9Dh, and 9Eh, are always decoded to LPC.
1	Reserved
0	BIOS Interface Lock-Down (BILD) — R/WLO. 0 = Disabled. 1 = Prevents BUC.TS (offset 3414, bit 0) and GCS.BBS (offset 3410h, bits 11:10) from being changed. This bit can only be written from 0 to 1 once.



10.1.44 BUC—Backed Up Control Register

Offset Address: 3414–3414h Attribute: R/W
 Default Value: 0000000xb Size: 8-bit

All bits in this register are in the RTC well and only cleared by RTCRST#.

Bit	Description
7:6	Reserved
5	<p>LAN Disable — R/W. 0 = LAN is Enabled 1 = LAN is Disabled. This bit is locked by the Function Disable SUS Well Lockdown register. Once locked, this bit can not be changed by software.</p>
4	<p>Daylight Savings Override (SDO) — R/W. 0 = Daylight Savings is Enabled. 1 = The DSE bit in RTC Register B is set to Read-only with a value of 0 to disable daylight savings.</p>
3:1	Reserved
0	<p>Top Swap (TS) — R/W. 0 = PCH will not invert A16. 1 = PCH will invert A16 for cycles going to the BIOS space (but not the feature space) in the FWH. If PCH is strapped for Top-Swap (GNT3# is low at rising edge of PWROK), then this bit cannot be cleared by software. The strap jumper should be removed and the system rebooted.</p>

10.1.45 FD—Function Disable Register

Offset Address: 3418–341Bh Attribute: R/W
 Default Value: See bit description Size: 32-bit

When disabling a function, only the configuration space is disabled. Software must ensure that all functionality within a controller that is not desired (such as memory spaces, I/O spaces, and DMA engines) is disabled prior to disabling the function.

When a function is disabled, software must not attempt to re-enable it. A disabled function can only be re-enabled by a platform reset.

Bit	Description
31:26	Reserved
25	<p>Serial ATA Disable 2 (SAD2) — R/W. Default is 0. 0 = The SATA controller #2 (D31:F5) is enabled. 1 = The SATA controller #2 (D31:F5) is disabled.</p>
24	<p>Thermal Throttle Disable (TTD) — R/W. Default is 0. 0 = Thermal Throttle is enabled. 1 = Thermal Throttle is disabled.</p>
23	<p>PCI Express* 8 Disable (PE8D) — R/W. Default is 0. When disabled, the link for this port is put into the "link down" state. 0 = PCI Express* port #8 is enabled. 1 = PCI Express port #8 is disabled.</p>



Bit	Description
22	PCI Express 7 Disable (PE7D) — R/W. Default is 0. When disabled, the link for this port is put into the link down state. 0 = PCI Express port #7 is enabled. 1 = PCI Express port #7 is disabled.
21	PCI Express* 6 Disable (PE6D) — R/W. Default is 0. When disabled, the link for this port is put into the "link down" state. 0 = PCI Express* port #6 is enabled. 1 = PCI Express port #6 is disabled.
20	PCI Express 5 Disable (PE5D) — R/W. Default is 0. When disabled, the link for this port is put into the link down state. 0 = PCI Express port #5 is enabled. 1 = PCI Express port #5 is disabled.
19	PCI Express 4 Disable (PE4D) — R/W. Default is 0. When disabled, the link for this port is put into the "link down" state. 0 = PCI Express port #4 is enabled. 1 = PCI Express port #4 is disabled. NOTE: This bit must be set when Port 1 is configured as a x4.
18	PCI Express 3 Disable (PE3D) — R/W. Default is 0. When disabled, the link for this port is put into the link down state. 0 = PCI Express port #3 is enabled. 1 = PCI Express port #3 is disabled. NOTE: This bit must be set when Port 1 is configured as a x4.
17	PCI Express 2 Disable (PE2D) — R/W. Default is 0. When disabled, the link for this port is put into the link down state. 0 = PCI Express port #2 is enabled. 1 = PCI Express port #2 is disabled. NOTE: This bit must be set when Port 1 is configured as a x4 or a x2.
16	PCI Express 1 Disable (PE1D) — R/W. Default is 0. When disabled, the link for this port is put into the link down state. 0 = PCI Express port #1 is enabled. 1 = PCI Express port #1 is disabled.
15	EHCI #1 Disable (EHCI1D) — R/W. Default is 0. 0 = The EHCI #1 is enabled. 1 = The EHCI #1 is disabled.
14	LPC Bridge Disable (LBD) — R/W. Default is 0. 0 = The LPC bridge is enabled. 1 = The LPC bridge is disabled. Unlike the other disables in this register, the following additional spaces will no longer be decoded by the LPC bridge: <ul style="list-style-type: none"> • Memory cycles below 16 MB (1000000h) • I/O cycles below 64 KB (10000h) • The Internal I/OxAPIC at FEC0_0000 to FECF_FFFF Memory cycle in the LPC BIOS range below 4 GB will still be decoded when this bit is set; however, the aliases at the top of 1 MB (the E and F segment) no longer will be decoded.
13	EHCI #2 Disable (EHCI2D) — R/W. Default is 0. 0 = The EHCI #2 is enabled. 1 = The EHCI #2 is disabled.
12:5	Reserved



Bit	Description
4	Intel® High Definition Audio Disable (HDAD) — R/W. Default is 0. 0 = The Intel® High Definition Audio controller is enabled. 1 = The Intel® High Definition Audio controller is disabled and its PCI configuration space is not accessible.
3	SMBus Disable (SD) — R/W. Default is 0. 0 = The SMBus controller is enabled. 1 = The SMBus controller is disabled. Setting this bit only disables the PCI configuration space.
2	Serial ATA Disable 1 (SAD1) — R/W. Default is 0. 0 = The SATA controller #1 (D31:F2) is enabled. 1 = The SATA controller #1 (D31:F2) is disabled.
1	PCI Bridge Disable — R/W. Default is 0. 0 = The PCI-to-PCI bridge (D30:F0) is enabled. 1 = The PCI-to-PCI bridge (D30:F0) is disabled.
0	BIOS must set this bit to 1b.

10.1.46 CG—Clock Gating Register

Offset Address: 341C–341Fh
Default Value: 00000000h

Attribute: R/W
Size: 32-bit

Bit	Description
31	Legacy (LPC) Dynamic Clock Gate Enable — R/W. 0 = Legacy Dynamic Clock Gating is Disabled 1 = Legacy Dynamic Clock Gating is Enabled
30	Reserved
29:28	CG Field 1 — R/W. BIOS must program this field to 11b.
27	SATA Port 3 Dynamic Clock Gate Enable — R/W. 0 = SATA Port 3 Dynamic Clock Gating is Disabled 1 = SATA Port 3 Dynamic Clock Gating is Enabled
26	SATA Port 2 Dynamic Clock Gate Enable — R/W. 0 = SATA Port 2 Dynamic Clock Gating is Disabled 1 = SATA Port 2 Dynamic Clock Gating is Enabled
25	SATA Port 1 Dynamic Clock Gate Enable — R/W. 0 = SATA Port 1 Dynamic Clock Gating is Disabled 1 = SATA Port 1 Dynamic Clock Gating is Enabled
24	SATA Port 0 Dynamic Clock Gate Enable — R/W. 0 = SATA Port 0 Dynamic Clock Gating is Disabled 1 = SATA Port 0 Dynamic Clock Gating is Enabled
23	LAN Static Clock Gating Enable (LANSCGE) — R/W. 0 = LAN Static Clock Gating is Disabled 1 = LAN Static Clock Gating is Enabled when the LAN Disable bit is set in the Backed Up Control RTC register.
22	High Definition Audio Dynamic Clock Gate Enable — R/W. 0 = High Definition Audio Dynamic Clock Gating is Disabled 1 = High Definition Audio Dynamic Clock Gating is Enabled



10.1.48 DISPBDF—Display Bus, Device and Function Initialization Register

Offset Address: 3424–3425h Attribute: R/W
 Default Value: 0010h Size: 16-bit

Bit	Description
15:8	Display Bus Number (DBN) — R/W. The bus number of the Display in the processor. BIOS should always program these bits as 0.
7:3	Display Device Number (DDN) — R/W. The device number of the Display in the processor. BIOS should always program these bits as 2.
2:0	Display Function Number (DFN) — R/W. The function number of the Display in the processor. BIOS should always program these bits as 0.

10.1.49 FD2—Function Disable 2 Register

Offset Address: 3428–342Bh Attribute: R/W
 Default Value: 00000000h Size: 32-bit

Bit	Description
31:5	Reserved
4	KT Disable (KTD) —R/W. Default is 0. 0 = Keyboard Text controller (D22:F3) is enabled. 1 = Keyboard Text controller (D22:F3) is Disabled
3	IDE-R Disable (IRERD) —R/W. Default is 0. 0 = IDE Redirect controller (D22:F2) is Enabled. 1 = IDE Redirect controller (D22:F2) is Disabled.
2	Intel® MEI #2 Disable (MEI2D) —R/W. Default is 0. 0 = Intel MEI controller #2 (D22:F1) is enabled. 1 = Intel MEI controller #2 (D22:F1) is disabled.
1	Intel MEI #1 Disable (MEI1D) —R/W. Default is 0. 0 = Intel MEI controller #1 (D22:F0) is enabled. 1 = Intel MEI controller #1 (D22:F0) is disabled.
0	Display BDF Enable (DBDFEN) —R/W.



10.1.50 MISCCTL—Miscellaneous Control Register

Offset Address: 3590–3593h Attribute: R/W
Default Value: 00000000h Size: 32-bit

This register is in the suspend well. This register is not reset on D3-to-D0, HCRESET nor core well reset.

Bit	Description
31:2	Reserved
1	EHCI 2 USBR Enable — R/W. When set, this bit enables support for the USB-r redirect device on the EHCI controller in Device 26. SW must complete programming the following registers before this bit is set: 1. Enable RMH 2. HCSPARAMS (N_CC, N_Ports)
0	EHCI 1 USBR Enable — R/W. When set, this bit enables support for the USB-r redirect device on the EHCI controller in Device 29. SW must complete programming the following registers before this bit is set: 1. Enable RMH 2. HCSPARAMS (N_CC, N_Ports)



10.1.51 USBOCM1—Overcurrent MAP Register 1

Offset Address: 35A0–35A3h Attribute: R/W0
 Default Value: C0300C03h Size: 32-bit

All bits in this register are in the Resume Well and is only cleared by RSMRST#.

Bit	Description																		
31:24	<p>OC3 Mapping Each bit position maps OC3# to a set of ports as follows: The OC3# pin is ganged to the overcurrent signal of each port that has its corresponding bit set. It is software responsibility to ensure that a given port's bit map is set only for one OC pin.</p> <table> <tr> <td>Bit</td> <td>31</td> <td>30</td> <td>29</td> <td>28</td> <td>27</td> <td>26</td> <td>25</td> <td>24</td> </tr> <tr> <td>Port</td> <td>7</td> <td>6</td> <td>5</td> <td>4</td> <td>3</td> <td>2</td> <td>1</td> <td>0</td> </tr> </table>	Bit	31	30	29	28	27	26	25	24	Port	7	6	5	4	3	2	1	0
Bit	31	30	29	28	27	26	25	24											
Port	7	6	5	4	3	2	1	0											
23:16	<p>OC2 Mapping Each bit position maps OC2# to a set of ports as follows: The OC2# pin is ganged to the overcurrent signal of each port that has its corresponding bit set. It is software responsibility to ensure that a given port's bit map is set only for one OC pin.</p> <table> <tr> <td>Bit</td> <td>23</td> <td>22</td> <td>21</td> <td>20</td> <td>19</td> <td>18</td> <td>17</td> <td>16</td> </tr> <tr> <td>Port</td> <td>7</td> <td>6</td> <td>5</td> <td>4</td> <td>3</td> <td>2</td> <td>1</td> <td>0</td> </tr> </table>	Bit	23	22	21	20	19	18	17	16	Port	7	6	5	4	3	2	1	0
Bit	23	22	21	20	19	18	17	16											
Port	7	6	5	4	3	2	1	0											
15:8	<p>OC1 Mapping Each bit position maps OC1# to a set of ports as follows: The OC1# pin is ganged to the overcurrent signal of each port that has its corresponding bit set. It is software responsibility to ensure that a given port's bit map is set only for one OC pin.</p> <table> <tr> <td>Bit</td> <td>15</td> <td>14</td> <td>13</td> <td>12</td> <td>11</td> <td>10</td> <td>9</td> <td>8</td> </tr> <tr> <td>Port</td> <td>7</td> <td>6</td> <td>5</td> <td>4</td> <td>3</td> <td>2</td> <td>1</td> <td>0</td> </tr> </table>	Bit	15	14	13	12	11	10	9	8	Port	7	6	5	4	3	2	1	0
Bit	15	14	13	12	11	10	9	8											
Port	7	6	5	4	3	2	1	0											
7:0	<p>OC0 Mapping Each bit position maps OC0# to a set of ports as follows: The OC0# pin is ganged to the overcurrent signal of each port that has its corresponding bit set. It is software responsibility to ensure that a given port's bit map is set only for one OC pin.</p> <table> <tr> <td>Bit</td> <td>7</td> <td>6</td> <td>5</td> <td>4</td> <td>3</td> <td>2</td> <td>1</td> <td>0</td> </tr> <tr> <td>Port</td> <td>7</td> <td>6</td> <td>5</td> <td>4</td> <td>3</td> <td>2</td> <td>1</td> <td>0</td> </tr> </table>	Bit	7	6	5	4	3	2	1	0	Port	7	6	5	4	3	2	1	0
Bit	7	6	5	4	3	2	1	0											
Port	7	6	5	4	3	2	1	0											



10.1.52 USB0CM2—Overcurrent MAP Register 2

Offset Address: 35A4–35A7h Attribute: R/W0
 Default Value: 00000000h Size: 32-bit

All bits in this register are in the Resume Well and is only cleared by RSMRST#

Bit	Description														
31:30	Reserved														
29:24	<p>OC7 Mapping Each bit position maps OC7# to a set of ports as follows: The OC7# pin is ganged to the overcurrent signal of each port that has its corresponding bit set. It is software responsibility to ensure that a given port's bit map is set only for one OC pin.</p> <table border="1"> <tr> <td>Bit</td> <td>29</td> <td>28</td> <td>27</td> <td>26</td> <td>25</td> <td>24</td> </tr> <tr> <td>Port</td> <td>13</td> <td>12</td> <td>11</td> <td>10</td> <td>9</td> <td>8</td> </tr> </table>	Bit	29	28	27	26	25	24	Port	13	12	11	10	9	8
Bit	29	28	27	26	25	24									
Port	13	12	11	10	9	8									
23:22	Reserved														
21:16	<p>OC6 Mapping Each bit position maps OC6# to a set of ports as follows: The OC6# pin is ganged to the overcurrent signal of each port that has its corresponding bit set. It is software responsibility to ensure that a given port's bit map is set only for one OC pin.</p> <table border="1"> <tr> <td>Bit</td> <td>21</td> <td>20</td> <td>19</td> <td>18</td> <td>17</td> <td>16</td> </tr> <tr> <td>Port</td> <td>13</td> <td>12</td> <td>11</td> <td>10</td> <td>9</td> <td>8</td> </tr> </table>	Bit	21	20	19	18	17	16	Port	13	12	11	10	9	8
Bit	21	20	19	18	17	16									
Port	13	12	11	10	9	8									
15:14	Reserved														
13:8	<p>OC5 Mapping Each bit position maps OC5# to a set of ports as follows: The OC5# pin is ganged to the overcurrent signal of each port that has its corresponding bit set. It is software responsibility to ensure that a given port's bit map is set only for one OC pin.</p> <table border="1"> <tr> <td>Bit</td> <td>13</td> <td>12</td> <td>11</td> <td>10</td> <td>9</td> <td>8</td> </tr> <tr> <td>Port</td> <td>13</td> <td>12</td> <td>11</td> <td>10</td> <td>9</td> <td>8</td> </tr> </table>	Bit	13	12	11	10	9	8	Port	13	12	11	10	9	8
Bit	13	12	11	10	9	8									
Port	13	12	11	10	9	8									
7:6	Reserved														
5:0	<p>OC4 Mapping Each bit position maps OC4# to a set of ports as follows: The OC4# pin is ganged to the overcurrent signal of each port that has its corresponding bit set. It is software responsibility to ensure that a given port's bit map is set only for one OC pin.</p> <table border="1"> <tr> <td>Bit</td> <td>5</td> <td>4</td> <td>3</td> <td>2</td> <td>1</td> <td>0</td> </tr> <tr> <td>Port</td> <td>13</td> <td>12</td> <td>11</td> <td>10</td> <td>9</td> <td>8</td> </tr> </table>	Bit	5	4	3	2	1	0	Port	13	12	11	10	9	8
Bit	5	4	3	2	1	0									
Port	13	12	11	10	9	8									



10.1.53 RMHWKCTL—Rate Matching Hub Wake Control Register

Offset Address: 35B0–35B3h Attribute: R/W
 Default Value: 00000000h Size: 32-bit

All bits in this register are in the Resume Well and is only cleared by RSMRST#.

Bit	Description
31:10	Reserved
9	RMH 2 Inherit EHCI2 Wake Control Settings: When this bit is set, the RMH behaves as if bits 6:4 of this register reflect the appropriate bits of EHCI PORTSC0 bits 22:20.
8	RMH 1 Inherit EHCI1 Wake Control Settings: When this bit is set, the RMH behaves as if bits 2:0 of this register reflect the appropriate bits of EHCI PORTSC0 bits 22:20.
7	RMH 2 Upstream Wake on Device Resume This bit governs the hub behavior when globally suspended and the system is in Sx. 0 = Enables the port to be sensitive to device initiated resume events as system wake-up events; that is, the hub will initiate a resume on its upstream port and cause a wake from Sx when a device resume occurs on an enabled DS port 1 = Device resume event is seen on a downstream port, the hub does not initiate a wake upstream and does not cause a wake from Sx
6	RMH 2 Upstream Wake on OC Disable This bit governs the hub behavior when globally suspended and the system is in Sx. 0 = Enables the port to be sensitive to over-current conditions as system wake-up events; that is, the hub will initiate a resume on its upstream port and cause a wake from Sx when an OC condition occurs on an enabled DS port 1 = Over-current event does not initiate a wake upstream and does not cause a wake from Sx
5	RMH 2 Upstream Wake on Disconnect Disable This bit governs the hub behavior when globally suspended and the system is in Sx 0 = Enables disconnect events on downstream port to be treated as resume events to be propagated upstream. In this case, it is allowed to initiate a wake on its upstream port and cause a system wake from Sx in response to a disconnect event on a downstream port 1 = Downstream disconnect events do not initiate a resume on its upstream port or cause a resume from Sx.
4	RMH 2 Upstream Wake on Connect Enable This bit governs the hub behavior when globally suspended and the system is in Sx. 0 = Enables connect events on a downstream port to be treated as resume events to be propagated upstream. As well as waking up the system from Sx. 1 = Downstream connect events do not wake the system from Sx nor does it initiate a resume on its upstream port.
3	RMH 1 Upstream Wake on Device Resume This bit governs the hub behavior when globally suspended and the system is in Sx. 0 = Enables the port to be sensitive to device initiated resume events as system wake-up events; that is, the hub will initiate a resume on its upstream port and cause a wake from Sx when a device resume occurs on an enabled DS port 1 = Device resume event is seen on a downstream port, the hub does not initiate a wake upstream and does not cause a wake from Sx

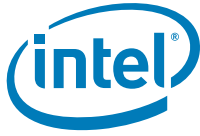

Bit	Description
2	RMH 1 Upstream Wake on OC Disable This bit governs the hub behavior when globally suspended and the system is in Sx. 0 = Enables the port to be sensitive to over-current conditions as system wake-up events. That is, the hub will initiate a resume on its upstream port and cause a wake from Sx when an OC condition occurs on an enabled DS port 1 = Over-current event does not initiate a wake upstream and does not cause a wake from Sx
1	RMH 1 Upstream Wake on Disconnect Disable This bit governs the hub behavior when globally suspended and the system is in Sx 0 = Enables disconnect events on downstream port to be treated as resume events to be propagated upstream. In this case, it is allowed to initiate a wake on its upstream port and cause a system wake from Sx in response to a disconnect event on a downstream port 1 = Downstream disconnect events do not initiate a resume on its upstream port or cause a resume from Sx.
0	RMH 1 Upstream Wake on Connect Enable This bit governs the hub behavior when globally suspended and the system is in Sx. 0 = Enables connect events on a downstream port to be treated as resume events to be propagated upstream. As well as waking up the system from Sx. 1 = Downstream connect events do not wake the system from Sx nor does it initiate a resume on its upstream port.

§ §



11 PCI-to-PCI Bridge Registers (D30:F0)

The PCH PCI bridge resides in PCI Device 30, Function 0 on bus #0. This implements the buffering and control logic between PCI and the backbone. The arbitration for the PCI bus is handled by this PCI device.

11.1 PCI Configuration Registers (D30:F0)

Note: Address locations that are not shown should be treated as Reserved (see [Section 9.2](#) for details).

Table 11-1. PCI Bridge Register Address Map (PCI-PCI—D30:F0)

Offset	Mnemonic	Register Name	Default	Attribute
00h–01h	VID	Vendor Identification	8086h	RO
02h–03h	DID	Device Identification	See register description	RO
04h–05h	PCICMD	PCI Command	0000h	R/W, RO
06h–07h	PSTS	PCI Status	0010h	R/WC, RO
08h	RID	Revision Identification	See register description	RO
09h–0Bh	CC	Class Code	060401h	RO
0Dh	PMLT	Primary Master Latency Timer	00h	RO
0Eh	HEADTYP	Header Type	01h	RO
18h–1Ah	BNUM	Bus Number	000000h	RO
1Bh	SMLT	Secondary Master Latency Timer	00h	R/W
1Ch–1Dh	IOBASE_LIMIT	I/O Base and Limit	0000h	R/W, RO
1Eh–1Fh	SECSTS	Secondary Status	0280h	R/WC, RO
20h–23h	MEMBASE_LIMIT	Memory Base and Limit	00000000h	R/W
24h–27h	PREF_MEM_BASE_LIMIT	Prefetchable Memory Base and Limit	00010001h	R/W, RO
28h–2Bh	PMBU32	Prefetchable Memory Upper 32 Bits	00000000h	R/W
2Ch–2Fh	PMLU32	Prefetchable Memory Limit Upper 32 Bits	00000000h	R/W
34h	CAPP	Capability List Pointer	50h	RO
3Ch–3Dh	INTR	Interrupt Information	0000h	R/W, RO
3Eh–3Fh	BCTRL	Bridge Control	0000h	R/WC, RO, R/W
40h–41h	SPDH	Secondary PCI Device Hiding	0000h	R/W, RO
44h–47h	DTC	Delayed Transaction Control	00000000h	R/W
48h–4Bh	BPS	Bridge Proprietary Status	00000000h	R/WC, RO
4Ch–4Fh	BPC	Bridge Policy Configuration	10001200h	R/W, RO
50h–51h	SVCAP	Subsystem Vendor Capability Pointer	000Dh	RO
54h–57h	SVID	Subsystem Vendor IDs	00000000h	R/WO



11.1.1 VID— Vendor Identification Register (PCI-PCI—D30:F0)

Offset Address: 00h–01h Attribute: RO
Default Value: 8086h Size: 16 bits

Bit	Description
15:0	Vendor ID — RO. This is a 16-bit value assigned to Intel. Intel VID = 8086h.

11.1.2 DID— Device Identification Register (PCI-PCI—D30:F0)

Offset Address: 02h–03h Attribute: RO
Default Value: See bit description Size: 16 bits

Bit	Description
15:0	Device ID — RO. This is a 16-bit value assigned to the PCI bridge.

11.1.3 PCICMD—PCI Command (PCI-PCI—D30:F0)

Offset Address: 04h–05h Attribute: R/W, RO
Default Value: 0000h Size: 16 bits

Bit	Description
15:11	Reserved
10	Interrupt Disable (ID) — RO. Hardwired to 0. The PCI bridge has no interrupts to disable.
9	Fast Back to Back Enable (FBE) — RO. Hardwired to 0, per the <i>PCI Express* Base Specification, Revision 1.0a</i> .
8	SERR# Enable (SERR_EN) — R/W. 0 = Disable. 1 = Enable the PCH to generate an NMI (or SMI# if NMI routed to SMI#) when the D30:F0 SSE bit (offset 06h, bit 14) is set.
7	Wait Cycle Control (WCC) — RO. Hardwired to 0, per the <i>PCI Express* Base Specification, Revision 1.0a</i> .
6	Parity Error Response (PER) — R/W. 0 = The PCH ignores parity errors on the PCI bridge. 1 = The PCH will set the SSE bit (D30:F0, offset 06h, bit 14) when parity errors are detected on the PCI bridge.
5	VGA Palette Snoop (VPS) — RO. Hardwired to 0, per the <i>PCI Express* Base Specification, Revision 1.0a</i> .
4	Memory Write and Invalidate Enable (MWE) — RO. Hardwired to 0, per the <i>PCI Express* Base Specification, Revision 1.0a</i> .
3	Special Cycle Enable (SCE) — RO. Hardwired to 0, per the <i>PCI Express* Base Specification, Revision 1.0a</i> and the <i>PCI-to-PCI Bridge Specification</i> .

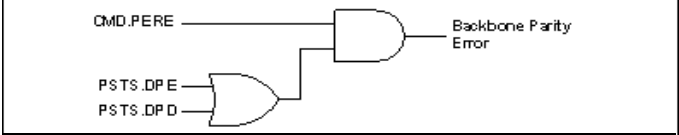
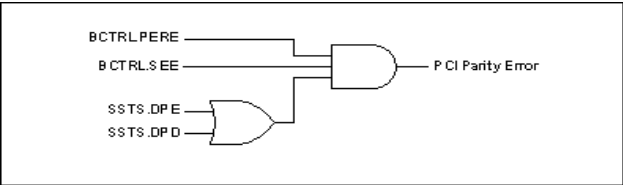
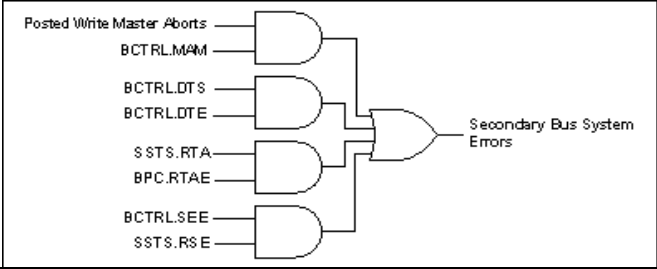
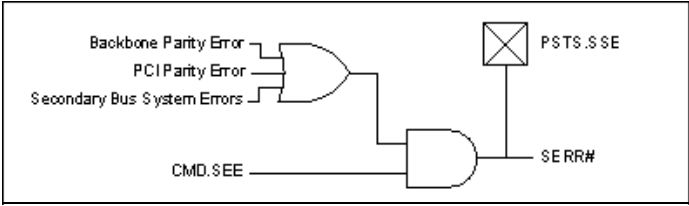
Bit	Description
	<p>Signaled System Error (SSE) — R/WC. Several internal and external sources of the bridge can cause SERR#. The first class of errors is parity errors related to the backbone. The PCI bridge captures generic data parity errors (errors it finds on the backbone) as well as errors returned on backbone cycles where the bridge was the master. If either of these two conditions is met, and the primary side of the bridge is enabled for parity error response, SERR# will be captured as shown below.</p>  <p>As with the backbone, the PCI bus captures the same sets of errors. The PCI bridge captures generic data parity errors (errors it finds on PCI) as well as errors returned on PCI cycles where the bridge was the master. If either of these two conditions is met, and the secondary side of the bridge is enabled for parity error response, SERR# will be captured as shown below.</p>  <p>14 The final class of errors is system bus errors. There are three status bits associated with system bus errors, each with a corresponding enable. The diagram capturing this is shown below.</p>  <p>After checking for the three above classes of errors, an SERR# is generated, and PSTS.SSE logs the generation of SERR#, if CMD.SEE (D30:F0:04, bit 8) is set, as shown below.</p> 
13	<p>Received Master Abort (RMA) — R/WC. 0 = No master abort received. 1 = Set when the bridge receives a master abort status from the backbone.</p>
12	<p>Received Target Abort (RTA) — R/WC. 0 = No target abort received. 1 = Set when the bridge receives a target abort status from the backbone.</p>



11.1.12 SECSTS—Secondary Status Register (PCI-PCI—D30:F0)

Offset Address: 1Eh-1Fh
 Default Value: 0280h

Attribute: R/WC, RO
 Size: 16 bits

Note: For the writable bits, software must write a 1 to clear bits that are set. Writing a 0 to the bit has no effect.

Bit	Description
15	Detected Parity Error (DPE) — R/WC. 0 = Parity error not detected. 1 = PCH PCI bridge detected an address or data parity error on the PCI bus
14	Received System Error (RSE) — R/WC. 0 = SERR# assertion not received 1 = SERR# assertion is received on PCI.
13	Received Master Abort (RMA) — R/WC. 0 = No master abort. 1 = This bit is set whenever the bridge is acting as an initiator on the PCI bus and the cycle is master-aborted. For processor/PCH interface packets that have completion required, this must also cause a target abort to be returned and sets PSTS.STA. (D30:F0:06 bit 11)
12	Received Target Abort (RTA) — R/WC. 0 = No target abort. 1 = This bit is set whenever the bridge is acting as an initiator on PCI and a cycle is target-aborted on PCI. For processor/PCH interface packets that have completion required, this event must also cause a target abort to be returned, and sets PSTS.STA. (D30:F0:06 bit 11).
11	Signaled Target Abort (STA) — R/WC. 0 = No target abort. 1 = This bit is set when the bridge is acting as a target on the PCI Bus and signals a target abort.
10:9	DEVSEL# Timing (DEVT) — RO. 01h = Medium decode timing.
8	Data Parity Error Detected (DPD) — R/WC. 0 = Conditions described below not met. 1 = The PCH sets this bit when all of the following three conditions are met: <ul style="list-style-type: none"> • The bridge is the initiator on PCI. • PERR# is detected asserted or a parity error is detected internally • BCTRL.PERE (D30:F0:3E bit 0) is set.
7	Fast Back to Back Capable (FBC) — RO. Hardwired to 1 to indicate that the PCI to PCI target logic is capable of receiving fast back-to-back cycles.
6	Reserved
5	66 MHz Capable (66MHZ_CAP) — RO. Hardwired to 0. This bridge is 33 MHz capable only.
4:0	Reserved



11.1.15 PMBU32—Prefetchable Memory Base Upper 32 Bits Register (PCI-PCI—D30:F0)

Offset Address: 28h–2Bh Attribute: R/W
Default Value: 00000000h Size: 32 bits

Bit	Description
31:0	Prefetchable Memory Base Upper Portion (PMBU) — R/W. Upper 32-bits of the prefetchable address base.

11.1.16 PMLU32—Prefetchable Memory Limit Upper 32 Bits Register (PCI-PCI—D30:F0)

Offset Address: 2C–2Fh Attribute: R/W
Default Value: 00000000h Size: 32 bits

Bit	Description
31:0	Prefetchable Memory Limit Upper Portion (PMLU) — R/W. Upper 32-bits of the prefetchable address limit.

11.1.17 CAPP—Capability List Pointer Register (PCI-PCI—D30:F0)

Offset Address: 34h Attribute: RO
Default Value: 50h Size: 8 bits

Bit	Description
7:0	Capabilities Pointer (PTR) — RO. Indicates that the pointer for the first entry in the capabilities list is at 50h in configuration space.

11.1.18 INTR—Interrupt Information Register (PCI-PCI—D30:F0)

Offset Address: 3Ch–3Dh Attribute: R/W, RO
Default Value: 0000h Size: 16 bits

Bit	Description
15:8	Interrupt Pin (IPIN) — RO. The PCI bridge does not assert an interrupt.
7:0	Interrupt Line (ILINE) — R/W. Software written value to indicate which interrupt line (vector) the interrupt is connected to. No hardware action is taken on this register. Since the bridge does not generate an interrupt, BIOS should program this value to FFh as per the PCI bridge specification.



11.1.19 BCTRL—Bridge Control Register (PCI-PCI—D30:F0)

Offset Address: 3Eh–3Fh
Default Value: 0000h

Attribute: R/WC, RO, R/W
Size: 16 bits

Bit	Description
15:12	Reserved
11	Discard Timer SERR# Enable (DTE) — R/W. Controls the generation of SERR# on the primary interface in response to the DTS bit being set: 0 = Do not generate SERR# on a secondary timer discard 1 = Generate SERR# in response to a secondary timer discard
10	Discard Timer Status (DTS) — R/WC. This bit is set to 1 when the secondary discard timer (see the SDT bit below) expires for a delayed transaction in the hard state.
9	Secondary Discard Timer (SDT) — R/W. This bit sets the maximum number of PCI clock cycles that the PCH waits for an initiator on PCI to repeat a delayed transaction request. The counter starts once the delayed transaction data is has been returned by the system and is in a buffer in the PCH PCI bridge. If the master has not repeated the transaction at least once before the counter expires, the PCH PCI bridge discards the transaction from its queue. 0 = The PCI master timeout value is between 2^{15} and 2^{16} PCI clocks 1 = The PCI master timeout value is between 2^{10} and 2^{11} PCI clocks
8	Primary Discard Timer (PDT) — R/W. This bit is R/W for software compatibility only.
7	Fast Back to Back Enable (FBE) — RO. Hardwired to 0. The PCI logic will not generate fast back-to-back cycles on the PCI bus.
6	Secondary Bus Reset (SBR) — R/W. Controls PCIRST# assertion on PCI. 0 = Bridge deasserts PCIRST# 1 = Bridge asserts PCIRST#. When PCIRST# is asserted, the delayed transaction buffers, posting buffers, and the PCI bus are initialized back to reset conditions. The rest of the part and the configuration registers are not affected.
5	Master Abort Mode (MAM) — R/W. Controls the PCH PCI bridge's behavior when a master abort occurs: Master Abort on processor /PCH Interconnect (DMI): 0 = Bridge asserts TRDY# on PCI. It drives all 1s for reads, and discards data on writes. 1 = Bridge returns a target abort on PCI. Master Abort PCI (non-locked cycles): 0 = Normal completion status will be returned on the processor/PCH interconnect. 1 = Target abort completion status will be returned on the processor/PCH interconnect. NOTE: All locked reads will return a completer abort completion status on the processor/PCH interconnect.
4	VGA 16-Bit Decode (V16D) — R/W. Enables the PCH PCI bridge to provide 16-bits decoding of VGA I/O address precluding the decode of VGA alias addresses every 1 KB. This bit requires the VGAE bit in this register be set.



Bit	Description
2	Memory Read Multiple Prefetch Disable (MRMPD) — R/W. 0 = MRM commands will fetch multiple cache lines as defined by the prefetch algorithm. 1 = Memory read multiple (MRM) commands will fetch only up to a single, 64-byte aligned cache line.
1	Memory Read Line Prefetch Disable (MRLPD) — R/W. 0 = MRL commands will fetch multiple cache lines as defined by the prefetch algorithm. 1 = Memory read line (MRL) commands will fetch only up to a single, 64-byte aligned cache line.
0	Memory Read Prefetch Disable (MRPD) — R/W. 0 = MR commands will fetch up to a 64-byte aligned cache line. 1 = Memory read (MR) commands will fetch only a single DW.

11.1.22 BPS—Bridge Proprietary Status Register (PCI-PCI—D30:F0)

Offset Address: 48h-4Bh
Default Value: 00000000h

Attribute: R/WC, RO
Size: 32 bits

Bit	Description
31:17	Reserved
16	PERR# Assertion Detected (PAD) — R/WC. This bit is set by hardware whenever the PERR# pin is asserted on the rising edge of PCI clock. This includes cases in which the chipset is the agent driving PERR#. It remains asserted until cleared by software writing a 1 to this location. When enabled by the PERR#-to-SERR# Enable bit (in the Bridge Policy Configuration register), a 1 in this bit can generate an internal SERR# and be a source for the NMI logic. This bit can be used by software to determine the source of a system problem.
15:7	Reserved
6:4	Number of Pending Transactions (NPT) — RO. This read-only indicator tells debug software how many transactions are in the pending queue. Possible values are: 000 = No pending transaction 001 = 1 pending transaction 010 = 2 pending transactions 011 = 3 pending transactions 100 = 4 pending transactions 101 = 5 pending transactions 110-111 = Reserved NOTE: This field is not valid if DTC.MDT (offset 44h:bits 7:6) is any value other than '00'.
3:2	Reserved
1:0	Number of Active Transactions (NAT) — RO. This read-only indicator tells debug software how many transactions are in the active queue. Possible values are: 00 = No active transactions 01 = 1 active transaction 10 = 2 active transactions 11 = Reserved



Bit	Description																				
7	<p>Subtractive Decode Policy (SDP) — R/W.</p> <p>0 = The PCI bridge always forwards memory and I/O cycles that are not claimed by any other device on the backbone (primary interface) to the PCI bus (secondary interface).</p> <p>1 = The PCI bridge will not claim and forward memory or I/O cycles at all unless the corresponding Space Enable bit is set in the Command register.</p> <p>NOTE: The Boot BIOS Destination Selection strap can force the BIOS accesses to PCI.</p> <table border="1"> <thead> <tr> <th>CMD.MSE</th> <th>BPC.SDP</th> <th>Range</th> <th>Forwarding Policy</th> </tr> </thead> <tbody> <tr> <td>0</td> <td>0</td> <td>Don't Care</td> <td>Forward unclaimed cycles</td> </tr> <tr> <td>0</td> <td>1</td> <td>Don't Care</td> <td>Forwarding Prohibited</td> </tr> <tr> <td>1</td> <td>X</td> <td>Within range</td> <td>Positive decode and forward</td> </tr> <tr> <td>1</td> <td>X</td> <td>Outside</td> <td>Subtractive decode & forward</td> </tr> </tbody> </table>	CMD.MSE	BPC.SDP	Range	Forwarding Policy	0	0	Don't Care	Forward unclaimed cycles	0	1	Don't Care	Forwarding Prohibited	1	X	Within range	Positive decode and forward	1	X	Outside	Subtractive decode & forward
CMD.MSE	BPC.SDP	Range	Forwarding Policy																		
0	0	Don't Care	Forward unclaimed cycles																		
0	1	Don't Care	Forwarding Prohibited																		
1	X	Within range	Positive decode and forward																		
1	X	Outside	Subtractive decode & forward																		
6	<p>PERR#-to-SERR# Enable (PSE) — R/W. When this bit is set, a 1 in the PERR# Assertion status bit (in the Bridge Proprietary Status register) will result in an internal SERR# assertion on the primary side of the bridge (if also enabled by the SERR# Enable bit in the primary Command register). SERR# is a source of NMI.</p>																				
5	<p>Secondary Discard Timer Testmode (SDTT) — R/W.</p> <p>0 = The secondary discard timer expiration will be defined in BCTRL.SDT (D30:F0:3E, bit 9)</p> <p>1 = The secondary discard timer will expire after 128 PCI clocks.</p>																				
4:3	Reserved																				
2	<p>Peer Decode Enable (PDE) — R/W.</p> <p>0 = The PCI bridge assumes that all memory cycles target main memory, and all I/O cycles are not claimed.</p> <p>1 = The PCI bridge will perform peer decode on any memory or I/O cycle from PCI that falls outside of the memory and I/O window registers</p>																				
1	Reserved																				
0	<p>Received Target Abort SERR# Enable (RTAE) — R/W. When set, the PCI bridge will report SERR# when PSTS.RTA (D30:F0:06 bit 12) or SSTS.RTA (D30:F0:1E bit 12) are set, and CMD.SEE (D30:F0:04 bit 8) is set.</p>																				

11.1.24 SVCAP—Subsystem Vendor Capability Register (PCI-PCI—D30:F0)

Offset Address: 50h–51h Attribute: RO
 Default Value: 000Dh Size: 16 bits

Bit	Description
15:8	Next Capability (NEXT) — RO. Value of 00h indicates this is the last item in the list.
7:0	Capability Identifier (CID) — RO. Value of 0Dh indicates this is a PCI bridge subsystem vendor capability.



11.1.25 SVID—Subsystem Vendor IDs Register (PCI-PCI—D30:F0)

Offset Address: 54h–57h
 Default Value: 00000000h

Attribute: R/WO
 Size: 32 bits

Bit	Description
31:16	Subsystem Identifier (SID) — R/WO. Indicates the subsystem as identified by the vendor. This field is write once and is locked down until a bridge reset occurs (not the PCI bus reset).
15:0	Subsystem Vendor Identifier (SVID) — R/WO. Indicates the manufacturer of the subsystem. This field is write once and is locked down until a bridge reset occurs (not the PCI bus reset).

§ §





12 Gigabit LAN Configuration Registers

12.1 Gigabit LAN Configuration Registers (Gigabit LAN – D25:F0)

Note: Register address locations that are not shown in Table 12-1 should be treated as Reserved.

Table 12-1. Gigabit LAN Configuration Registers Address Map (Gigabit LAN – D25:F0) (Sheet 1 of 2)

Offset	Mnemonic	Register Name	Default	Attribute
00h–01h	VID	Vendor Identification	8086h	RO
02h–03h	DID	Device Identification	See register description	RO
04h–05h	PCICMD	PCI Command	0000h	R/W, RO
06h–07h	PCISTS	PCI Status	0010h	R/WC, RO
08h	RID	Revision Identification	See register description	RO
09h–0Bh	CC	Class Code	020000h	RO
0Ch	CLS	Cache Line Size	00h	R/W
0Dh	PLT	Primary Latency Timer	00h	RO
0Eh	HEADTYP	Header Type	00h	RO
10h–13h	MBARA	Memory Base Address A	00000000h	R/W, RO
14h–17h	MBARB	Memory Base Address B	00000000h	R/W, RO
18h–1Bh	MBARC	Memory Base Address C	00000001h	R/W, RO
2Ch–2Dh	SID	Subsystem ID	See register description	RO
2Eh–2Fh	SVID	Subsystem Vendor ID	See register description	RO
30h–33h	ERBA	Expansion ROM Base Address	See register description	RO
34h	CAPP	Capabilities List Pointer	C8h	RO
3Ch–3Dh	INTR	Interrupt Information	See register description	R/W, RO
3Eh	MLMG	Maximum Latency/Minimum Grant	00h	RO
C8h–C9h	CLIST1	Capabilities List 1	D001h	RO
CAh–CBh	PMC	PCI Power Management Capability	See register description	RO
CCh–CDh	PMCS	PCI Power Management Control and Status	See register description	R/WC, R/W, RO



12.1.3 PCICMD—PCI Command Register (Gigabit LAN—D25:F0)

Address Offset: 04h–05h
Default Value: 0000h

Attribute: R/W, RO
Size: 16 bits

Bit	Description
15:11	Reserved
10	<p>Interrupt Disable — R/W. This disables pin-based INTx# interrupts on enabled Hot-Plug and power management events. This bit has no effect on MSI operation.</p> <p>0 = Internal INTx# messages are generated if there is an interrupt for Hot-Plug or power management and MSI is not enabled.</p> <p>1 = Internal INTx# messages will not be generated.</p> <p>This bit does not affect interrupt forwarding from devices connected to the root port. Assert_INTx and Deassert_INTx messages will still be forwarded to the internal interrupt controllers if this bit is set.</p>
9	Fast Back to Back Enable (FBE) — RO. Hardwired to 0.
8	<p>SERR# Enable (SEE) — R/W.</p> <p>0 = Disable</p> <p>1 = Enables the Gb LAN controller to generate an SERR# message when PSTS.SSE is set.</p>
7	Wait Cycle Control (WCC) — RO. Hardwired to 0.
6	<p>Parity Error Response (PER) — R/W.</p> <p>0 = Disable.</p> <p>1 = Indicates that the device is capable of reporting parity errors as a master on the backbone.</p>
5	Palette Snoop Enable (PSE) — RO. Hardwired to 0.
4	Postable Memory Write Enable (PMWE) — RO. Hardwired to 0.
3	Special Cycle Enable (SCE) — RO. Hardwired to 0.
2	<p>Bus Master Enable (BME) — R/W.</p> <p>0 = Disable. All cycles from the device are master aborted</p> <p>1 = Enable. Allows the root port to forward cycles onto the backbone from a Gigabit LAN* device.</p>
1	<p>Memory Space Enable (MSE) — R/W.</p> <p>0 = Disable. Memory cycles within the range specified by the memory base and limit registers are master aborted on the backbone.</p> <p>1 = Enable. Allows memory cycles within the range specified by the memory base and limit registers can be forwarded to the Gigabit LAN device.</p>
0	<p>I/O Space Enable (IOSE) — R/W. This bit controls access to the I/O space registers.</p> <p>0 = Disable. I/O cycles within the range specified by the I/O base and limit registers are master aborted on the backbone.</p> <p>1 = Enable. Allows I/O cycles within the range specified by the I/O base and limit registers can be forwarded to the Gigabit LAN device.</p>

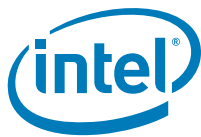

12.1.4 PCISTS—PCI Status Register (Gigabit LAN—D25:F0)

Address Offset: 06h-07h
 Default Value: 0010h

Attribute: R/WC, RO
 Size: 16 bits

Bit	Description
15	Detected Parity Error (DPE) — R/WC. 0 = No parity error detected. 1 = Set when the Gb LAN controller receives a command or data from the backbone with a parity error. This is set even if PCIMD.PER (D25:F0, bit 6) is not set.
14	Signaled System Error (SSE) — R/WC. 0 = No system error signaled. 1 = Set when the Gb LAN controller signals a system error to the internal SERR# logic.
13	Received Master Abort (RMA) — R/WC. 0 = Root port has not received a completion with unsupported request status from the backbone. 1 = Set when the GbE LAN controller receives a completion with unsupported request status from the backbone.
12	Received Target Abort (RTA) — R/WC. 0 = Root port has not received a completion with completer abort from the backbone. 1 = Set when the Gb LAN controller receives a completion with completer abort from the backbone.
11	Signaled Target Abort (STA) — R/WC. 0 = No target abort received. 1 = Set whenever the Gb LAN controller forwards a target abort received from the downstream device onto the backbone.
10:9	DEVSEL# Timing Status (DEV_STS) — RO. Hardwired to 0.
8	Master Data Parity Error Detected (DPED) — R/WC. 0 = No data parity error received. 1 = Set when the Gb LAN Controller receives a completion with a data parity error on the backbone and PCIMD.PER (D25:F0, bit 6) is set.
7	Fast Back to Back Capable (FB2BC) — RO. Hardwired to 0.
6	Reserved
5	66 MHz Capable — RO. Hardwired to 0.
4	Capabilities List — RO. Hardwired to 1. Indicates the presence of a capabilities list.
3	Interrupt Status — RO. Indicates status of Hot-Plug and power management interrupts on the root port that result in INTx# message generation. 0 = Interrupt is deasserted. 1 = Interrupt is asserted. This bit is not set if MSI is enabled. If MSI is not enabled, this bit is set regardless of the state of PCICMD.Interrupt Disable bit (D25:F0:04h:bit 10).
2:0	Reserved



12.1.10 MBARA—Memory Base Address Register A (Gigabit LAN—D25:F0)

Address Offset: 10h-13h Attribute: R/W, RO
Default Value: 00000000h Size: 32 bits

The internal CSR registers and memories are accessed as direct memory mapped offsets from the base address register. SW may only access whole DWord at a time.

Bit	Description
31:17	Base Address (BA) — R/W. Software programs this field with the base address of this region.
16:4	Memory Size (MSIZE) — R/W. Memory size is 128 KB.
3	Prefetchable Memory (PM) — RO. The GbE LAN controller does not implement prefetchable memory.
2:1	Memory Type (MT) — RO. Set to 00b indicating a 32 bit BAR.
0	Memory / IO Space (MIOS) — RO. Set to 0 indicating a Memory Space BAR.

12.1.11 MBARB—Memory Base Address Register B (Gigabit LAN—D25:F0)

Address Offset: 14h-17h Attribute: R/W, RO
Default Value: 00000000h Size: 32 bits

The internal registers that are used to access the LAN Space in the External FLASH device. Access to these registers are direct memory mapped offsets from the base address register. Software may only access a DWord at a time.

Bit	Description
31:12	Base Address (BA) — R/W. Software programs this field with the base address of this region.
11:4	Memory Size (MSIZE) — R/W. Memory size is 4 KB.
3	Prefetchable Memory (PM) — RO. The Gb LAN controller does not implement prefetchable memory.
2:1	Memory Type (MT) — RO. Set to 00b indicating a 32 bit BAR.
0	Memory / IO Space (MIOS) — RO. Set to 0 indicating a Memory Space BAR.



12.1.25 MADDL—Message Address Low Register (Gigabit LAN—D25:F0)

Address Offset: D4h–D7h Attribute: R/W
Default Value: See bit description Size: 32 bits

Bit	Description
31:0	Message Address Low (MADDL) — R/W. Written by the system to indicate the lower 32 bits of the address to use for the MSI memory write transaction. The lower two bits will always return 0 regardless of the write operation.

12.1.26 MADDH—Message Address High Register (Gigabit LAN—D25:F0)

Address Offset: D8h–DBh Attribute: R/W
Default Value: See bit description Size: 32 bits

Bit	Description
31:0	Message Address High (MADDH) — R/W. Written by the system to indicate the upper 32 bits of the address to use for the MSI memory write transaction.

12.1.27 MDAT—Message Data Register (Gigabit LAN—D25:F0)

Address Offset: DCh–DDh Attribute: R/W
Default Value: See bit description Size: 16 bits

Bit	Description
31:0	Message Data (MDAT) — R/W. Written by the system to indicate the lower 16 bits of the data written in the MSI memory write DWORD transaction. The upper 16 bits of the transaction are written as 0000h.

12.1.28 FLRCAP—Function Level Reset Capability (Gigabit LAN—D25:F0)

Address Offset: E0h–E1h Attribute: RO
Default Value: 0009h Size: 16 bits

Bit	Description
15:8	Next Pointer — RO. This field provides an offset to the next capability item in the capability list. The value of 00h indicates the last item in the list.
7:0	Capability ID — RO. The value of this field depends on the FLRCSSSEL bit. 13h = If FLRCSSSEL = 0 09h = If FLRCSSSEL = 1, indicating vendor specific capability.

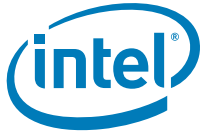



13 LPC Interface Bridge Registers (D31:F0)

The LPC bridge function of the PCH resides in PCI Device 31:Function 0. This function contains many other functional units, such as DMA and Interrupt controllers, Timers, Power Management, System Management, GPIO, RTC, and LPC Configuration Registers.

Registers and functions associated with other functional units are described in their respective sections.

13.1 PCI Configuration Registers (LPC I/F—D31:F0)

Note: Address locations that are not shown should be treated as Reserved.

Table 13-1. LPC Interface PCI Register Address Map (LPC I/F—D31:F0) (Sheet 1 of 2)

Offset	Mnemonic	Register Name	Default	Attribute
00h–01h	VID	Vendor Identification	8086h	RO
02h–03h	DID	Device Identification	See register description	RO
04h–05h	PCICMD	PCI Command	0007h	R/W, RO
06h–07h	PCISTS	PCI Status	0210h	R/WC, RO
08h	RID	Revision Identification	See register description	R/WO
09h	PI	Programming Interface	00h	RO
0Ah	SCC	Sub Class Code	01h	RO
0Bh	BCC	Base Class Code	06h	RO
0Dh	PLT	Primary Latency Timer	00h	RO
0Eh	HEADTYP	Header Type	80h	RO
2Ch–2Fh	SS	Sub System Identifiers	00000000h	R/WO
40h–43h	PMBASE	ACPI Base Address	00000001h	R/W, RO
44h	ACPI_CNTL	ACPI Control	00h	R/W
48h–4Bh	GPIOBASE	GPIO Base Address	00000001h	R/W, RO
4Ch	GC	GPIO Control	00h	R/W
60h–63h	PIRQ[n]_ROUT	PIRQ[A–D] Routing Control	80808080h	R/W
64h	SIRQ_CNTL	Serial IRQ Control	10h	R/W, RO
68h–6Bh	PIRQ[n]_ROUT	PIRQ[E–H] Routing Control	80808080h	R/W
6Ch–6Dh	LPC_IBDF	IOxAPIC Bus:Device:Function	00F8h	R/W
70h–7Fh	LPC_HnBDF	HPET Configuration	00F8h	R/W
80h	LPC_I/O_DEC	I/O Decode Ranges	0000h	R/W
82h–83h	LPC_EN	LPC I/F Enables	0000h	R/W
84h–87h	GEN1_DEC	LPC I/F Generic Decode Range 1	00000000h	R/W



13.1.11 SS—Sub System Identifiers Register (LPC I/F—D31:F0)

Offset Address: 2Ch–2Fh Attribute: R/WO
Default Value: 00000000h Size: 32 bits

This register is initialized to logic 0 by the assertion of PLTRST#. This register can be written only once after PLTRST# deassertion.

Bit	Description
31:16	Subsystem ID (SSID) — R/WO. This is written by BIOS. No hardware action taken on this value.
15:0	Subsystem Vendor ID (SSVID) — R/WO. This is written by BIOS. No hardware action taken on this value.

13.1.12 PMBASE—ACPI Base Address Register (LPC I/F—D31:F0)

Offset Address: 40h–43h Attribute: R/W, RO
Default Value: 00000001h Size: 32 bit
Lockable: No Usage: ACPI, Legacy
Power Well: Core

Sets base address for ACPI I/O registers, GPIO registers and TCO I/O registers. These registers can be mapped anywhere in the 64-K I/O space on 128-byte boundaries.

Bit	Description
31:16	Reserved
15:7	Base Address — R/W. This field provides 128 bytes of I/O space for ACPI, GPIO, and TCO logic. This is placed on a 128-byte boundary.
6:1	Reserved
0	Resource Type Indicator (RTE) — RO. Hardwired to 1 to indicate I/O space.



13.1.13 ACPI_CNTL—ACPI Control Register (LPC I/F — D31:F0)

Offset Address:	44h	Attribute:	R/W
Default Value:	00h	Size:	8 bit
Lockable:	No	Usage:	ACPI, Legacy
		Power Well:	Core

Bit	Description																		
7	<p>ACPI Enable (ACPI_EN) — R/W.</p> <p>0 = Disable. 1 = Decode of the I/O range pointed to by the ACPI base register is enabled, and the ACPI power management function is enabled. Note that the APM power management ranges (B2/B3h) are always enabled and are not affected by this bit.</p>																		
6:3	Reserved																		
2:0	<p>SCI IRQ Select (SCI_IRQ_SEL) — R/W.</p> <p>Specifies on which IRQ the SCI will internally appear. If not using the APIC, the SCI must be routed to IRQ9–11, and that interrupt is not sharable with the SERIRQ stream, but is shareable with other PCI interrupts. If using the APIC, the SCI can also be mapped to IRQ20–23, and can be shared with other interrupts.</p> <table> <thead> <tr> <th>Bits</th> <th>SCI Map</th> </tr> </thead> <tbody> <tr> <td>000b</td> <td>IRQ9</td> </tr> <tr> <td>001b</td> <td>IRQ10</td> </tr> <tr> <td>010b</td> <td>IRQ11</td> </tr> <tr> <td>011b</td> <td>Reserved</td> </tr> <tr> <td>100b</td> <td>IRQ20 (Only available if APIC enabled)</td> </tr> <tr> <td>101b</td> <td>IRQ21 (Only available if APIC enabled)</td> </tr> <tr> <td>110b</td> <td>IRQ22 (Only available if APIC enabled)</td> </tr> <tr> <td>111b</td> <td>IRQ23 (Only available if APIC enabled)</td> </tr> </tbody> </table> <p>When the interrupt is mapped to APIC interrupts 9, 10 or 11, the APIC should be programmed for active-high reception. When the interrupt is mapped to APIC interrupts 20 through 23, the APIC should be programmed for active-low reception.</p>	Bits	SCI Map	000b	IRQ9	001b	IRQ10	010b	IRQ11	011b	Reserved	100b	IRQ20 (Only available if APIC enabled)	101b	IRQ21 (Only available if APIC enabled)	110b	IRQ22 (Only available if APIC enabled)	111b	IRQ23 (Only available if APIC enabled)
Bits	SCI Map																		
000b	IRQ9																		
001b	IRQ10																		
010b	IRQ11																		
011b	Reserved																		
100b	IRQ20 (Only available if APIC enabled)																		
101b	IRQ21 (Only available if APIC enabled)																		
110b	IRQ22 (Only available if APIC enabled)																		
111b	IRQ23 (Only available if APIC enabled)																		

13.1.14 GPIOBASE—GPIO Base Address Register (LPC I/F — D31:F0)

Offset Address:	48h–4Bh	Attribute:	R/W, RO
Default Value:	0000001h	Size:	32 bit

Bit	Description
31:16	Reserved. Always 0.
15:7	Base Address (BA) — R/W. Provides the 128 bytes of I/O space for GPIO.
6:1	Reserved. Always 0.
0	RO. Hardwired to 1 to indicate I/O space.

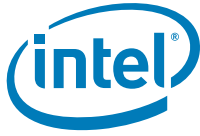

13.1.15 GC—GPIO Control Register (LPC I/F — D31:F0)

Offset Address: 4Ch
Default Value: 00h

Attribute: R/W
Size: 8 bit

Bit	Description
7:5	Reserved
4	GPIO Enable (EN) — R/W. This bit enables/disables decode of the I/O range pointed to by the GPIO Base Address register (D31:F0:48h) and enables the GPIO function. 0 = Disable. 1 = Enable.
3:1	Reserved
0	GPIO Lockdown Enable (GLE) — R/W. This bit enables lockdown of the following GPIO registers: <ul style="list-style-type: none">• Offset 00h: GPIO_USE_SEL• Offset 04h: GP_IO_SEL• Offset 0Ch: GP_LVL• Offset 30h: GPIO_USE_SEL2• Offset 34h: GP_IO_SEL2• Offset 38h: GP_LVL2• Offset 40h: GPIO_USE_SEL3• Offset 44h: GP_IO_SEL3• Offset 48h: GP_LVL3• Offset 60h: GP_RST_SEL 0 = Disable. 1 = Enable. When this bit is written from 1-to-0, an SMI# is generated, if enabled. This ensures that only SMM code can change the above GPIO registers after they are locked down.



13.1.16 PIRQ[n]_ROUT—PIRQ[A,B,C,D] Routing Control Register (LPC I/F—D31:F0)

Offset Address: PIRQA-60h, PIRQB-61h, PIRQC-62h, PIRQD-63h Attribute: R/W
 Default Value: 80h Size: 8 bit
 Lockable: No Power Well: Core

Bit	Description																																				
7	<p>Interrupt Routing Enable (IRQEN) — R/W.</p> <p>0 = The corresponding PIRQ is routed to one of the ISA-compatible interrupts specified in bits[3:0].</p> <p>1 = The PIRQ is not routed to the 8259.</p> <p>NOTE: BIOS must program this bit to 0 during POST for any of the PIRQs that are being used. The value of this bit may subsequently be changed by the OS when setting up for I/O APIC interrupt delivery mode.</p>																																				
6:4	Reserved																																				
3:0	<p>IRQ Routing — R/W. (ISA compatible.)</p> <table border="1"> <thead> <tr> <th>Value</th> <th>IRQ</th> <th>Value</th> <th>IRQ</th> </tr> </thead> <tbody> <tr> <td>0000b</td> <td>Reserved</td> <td>1000b</td> <td>Reserved</td> </tr> <tr> <td>0001b</td> <td>Reserved</td> <td>1001b</td> <td>IRQ9</td> </tr> <tr> <td>0010b</td> <td>Reserved</td> <td>1010b</td> <td>IRQ10</td> </tr> <tr> <td>0011b</td> <td>IRQ3</td> <td>1011b</td> <td>IRQ11</td> </tr> <tr> <td>0100b</td> <td>IRQ4</td> <td>1100b</td> <td>IRQ12</td> </tr> <tr> <td>0101b</td> <td>IRQ5</td> <td>1101b</td> <td>Reserved</td> </tr> <tr> <td>0110b</td> <td>IRQ6</td> <td>1110b</td> <td>IRQ14</td> </tr> <tr> <td>0111b</td> <td>IRQ7</td> <td>1111b</td> <td>IRQ15</td> </tr> </tbody> </table>	Value	IRQ	Value	IRQ	0000b	Reserved	1000b	Reserved	0001b	Reserved	1001b	IRQ9	0010b	Reserved	1010b	IRQ10	0011b	IRQ3	1011b	IRQ11	0100b	IRQ4	1100b	IRQ12	0101b	IRQ5	1101b	Reserved	0110b	IRQ6	1110b	IRQ14	0111b	IRQ7	1111b	IRQ15
Value	IRQ	Value	IRQ																																		
0000b	Reserved	1000b	Reserved																																		
0001b	Reserved	1001b	IRQ9																																		
0010b	Reserved	1010b	IRQ10																																		
0011b	IRQ3	1011b	IRQ11																																		
0100b	IRQ4	1100b	IRQ12																																		
0101b	IRQ5	1101b	Reserved																																		
0110b	IRQ6	1110b	IRQ14																																		
0111b	IRQ7	1111b	IRQ15																																		



13.1.18 PIRQ[n]_ROUT—PIRQ[E,F,G,H] Routing Control Register (LPC I/F—D31:F0)

Offset Address: PIRQE – 68h, PIRQF – 69h, Attribute: R/W
 PIRQG – 6Ah, PIRQH – 6Bh
 Default Value: 80h Size: 8 bit
 Lockable: No Power Well: Core

Bit	Description																																				
7	<p>Interrupt Routing Enable (IRQEN) — R/W.</p> <p>0 = The corresponding PIRQ is routed to one of the ISA-compatible interrupts specified in bits[3:0].</p> <p>1 = The PIRQ is not routed to the 8259.</p> <p>NOTE: BIOS must program this bit to 0 during POST for any of the PIRQs that are being used. The value of this bit may subsequently be changed by the OS when setting up for I/O APIC interrupt delivery mode.</p>																																				
6:4	Reserved																																				
3:0	<p>IRQ Routing — R/W. (ISA compatible.)</p> <table border="1"> <thead> <tr> <th>Value</th> <th>IRQ</th> <th>Value</th> <th>IRQ</th> </tr> </thead> <tbody> <tr> <td>0000b</td> <td>Reserved</td> <td>1000b</td> <td>Reserved</td> </tr> <tr> <td>0001b</td> <td>Reserved</td> <td>1001b</td> <td>IRQ9</td> </tr> <tr> <td>0010b</td> <td>Reserved</td> <td>1010b</td> <td>IRQ10</td> </tr> <tr> <td>0011b</td> <td>IRQ3</td> <td>1011b</td> <td>IRQ11</td> </tr> <tr> <td>0100b</td> <td>IRQ4</td> <td>1100b</td> <td>IRQ12</td> </tr> <tr> <td>0101b</td> <td>IRQ5</td> <td>1101b</td> <td>Reserved</td> </tr> <tr> <td>0110b</td> <td>IRQ6</td> <td>1110b</td> <td>IRQ14</td> </tr> <tr> <td>0111b</td> <td>IRQ7</td> <td>1111b</td> <td>IRQ15</td> </tr> </tbody> </table>	Value	IRQ	Value	IRQ	0000b	Reserved	1000b	Reserved	0001b	Reserved	1001b	IRQ9	0010b	Reserved	1010b	IRQ10	0011b	IRQ3	1011b	IRQ11	0100b	IRQ4	1100b	IRQ12	0101b	IRQ5	1101b	Reserved	0110b	IRQ6	1110b	IRQ14	0111b	IRQ7	1111b	IRQ15
Value	IRQ	Value	IRQ																																		
0000b	Reserved	1000b	Reserved																																		
0001b	Reserved	1001b	IRQ9																																		
0010b	Reserved	1010b	IRQ10																																		
0011b	IRQ3	1011b	IRQ11																																		
0100b	IRQ4	1100b	IRQ12																																		
0101b	IRQ5	1101b	Reserved																																		
0110b	IRQ6	1110b	IRQ14																																		
0111b	IRQ7	1111b	IRQ15																																		

13.1.19 LPC_IBDF—IOxAPIC Bus:Device:Function (LPC I/F—D31:F0)

Offset Address: 6Ch–6Dh Attribute: R/W
 Default Value: 00F8h Size: 16 bit

Bit	Description								
15:0	<p>IOxAPIC Bus:Device:Function (IBDF)— R/W. this field specifies the bus:device:function that PCH's IOxAPIC will be using for the following:</p> <ul style="list-style-type: none"> As the Requester ID when initiating Interrupt Messages to the processor. As the Completer ID when responding to the reads targeting the IOxAPIC's Memory-Mapped I/O registers. <p>The 16-bit field comprises the following:</p> <table border="1"> <thead> <tr> <th>Bits</th> <th>Description</th> </tr> </thead> <tbody> <tr> <td>15:8</td> <td>Bus Number</td> </tr> <tr> <td>7:3</td> <td>Device Number</td> </tr> <tr> <td>2:0</td> <td>Function Number</td> </tr> </tbody> </table> <p>This field defaults to Bus 0: Device 31: Function 0 after reset. BIOS can program this field to provide a unique bus:device:function number for the internal IOxAPIC.</p>	Bits	Description	15:8	Bus Number	7:3	Device Number	2:0	Function Number
Bits	Description								
15:8	Bus Number								
7:3	Device Number								
2:0	Function Number								



13.1.21 LPC_I/O_DEC—I/O Decode Ranges Register (LPC I/F—D31:F0)

Offset Address: 80h
Default Value: 0000h

Attribute: R/W
Size: 16 bit

Bit	Description
15:13	Reserved
12	FDD Decode Range — R/W. Determines which range to decode for the FDD Port 0 = 3F0h–3F5h, 3F7h (Primary) 1 = 370h–375h, 377h (Secondary)
11:10	Reserved
9:8	LPT Decode Range — R/W. This field determines which range to decode for the LPT Port. 00 = 378h–37Fh and 778h–77Fh 01 = 278h–27Fh (port 279h is read only) and 678h–67Fh 10 = 3BCh–3BEh and 7BCh–7BEh 11 = Reserved
7	Reserved
6:4	COMB Decode Range — R/W. This field determines which range to decode for the COMB Port. 000 = 3F8h–3FFh (COM1) 001 = 2F8h–2FFh (COM2) 010 = 220h–227h 011 = 228h–22Fh 100 = 238h–23Fh 101 = 2E8h–2EFh (COM4) 110 = 338h–33Fh 111 = 3E8h–3EFh (COM3)
3	Reserved
2:0	COMA Decode Range — R/W. This field determines which range to decode for the COMA Port. 000 = 3F8h–3FFh (COM1) 001 = 2F8h–2FFh (COM2) 010 = 220h–227h 011 = 228h–22Fh 100 = 238h–23Fh 101 = 2E8h–2EFh (COM4) 110 = 338h–33Fh 111 = 3E8h–3EFh (COM3)



13.1.22 LPC_EN—LPC I/F Enables Register (LPC I/F—D31:F0)

Offset Address: 82h–83h
 Default Value: 0000h

Attribute: R/W
 Size: 16 bit
 Power Well: Core

Bit	Description
15:14	Reserved
13	CNF2_LPC_EN — R/W. Microcontroller Enable # 2. 0 = Disable. 1 = Enables the decoding of the I/O locations 4Eh and 4Fh to the LPC interface. This range is used for a microcontroller.
12	CNF1_LPC_EN — R/W. Super I/O Enable. 0 = Disable. 1 = Enables the decoding of the I/O locations 2Eh and 2Fh to the LPC interface. This range is used for Super I/O devices.
11	MC_LPC_EN — R/W. Microcontroller Enable # 1. 0 = Disable. 1 = Enables the decoding of the I/O locations 62h and 66h to the LPC interface. This range is used for a microcontroller.
10	KBC_LPC_EN — R/W. Keyboard Enable. 0 = Disable. 1 = Enables the decoding of the I/O locations 60h and 64h to the LPC interface. This range is used for a microcontroller.
9	GAMEH_LPC_EN — R/W. High Gameport Enable 0 = Disable. 1 = Enables the decoding of the I/O locations 208h to 20Fh to the LPC interface. This range is used for a gameport.
8	GAMEL_LPC_EN — R/W. Low Gameport Enable 0 = Disable. 1 = Enables the decoding of the I/O locations 200h to 207h to the LPC interface. This range is used for a gameport.
7:4	Reserved
3	FDD_LPC_EN — R/W. Floppy Drive Enable 0 = Disable. 1 = Enables the decoding of the FDD range to the LPC interface. This range is selected in the LPC_FDD/LPT Decode Range Register (D31:F0:80h, bit 12).
2	LPT_LPC_EN — R/W. Parallel Port Enable 0 = Disable. 1 = Enables the decoding of the LPT range to the LPC interface. This range is selected in the LPC_FDD/LPT Decode Range Register (D31:F0:80h, bit 9:8).
1	COMB_LPC_EN — R/W. Com Port B Enable 0 = Disable. 1 = Enables the decoding of the COMB range to the LPC interface. This range is selected in the LPC_COM Decode Range Register (D31:F0:80h, bits 6:4).
0	COMA_LPC_EN — R/W. Com Port A Enable 0 = Disable. 1 = Enables the decoding of the COMA range to the LPC interface. This range is selected in the LPC_COM Decode Range Register (D31:F0:80h, bits 3:2).



13.1.23 GEN1_DEC—LPC I/F Generic Decode Range 1 Register (LPC I/F—D31:F0)

Offset Address: 84h–87h
Default Value: 00000000h

Attribute: R/W
Size: 32 bit
Power Well: Core

Bit	Description
31:24	Reserved
23:18	Generic I/O Decode Range Address[7:2] Mask — R/W. A 1 in any bit position indicates that any value in the corresponding address bit in a received cycle will be treated as a match. The corresponding bit in the Address field, below, is ignored. The mask is only provided for the lower 6 bits of the DWord address, allowing for decoding blocks up to 256 bytes in size.
17:16	Reserved
15:2	Generic I/O Decode Range 1 Base Address (GEN1_BASE) — R/W. NOTE: The PCH does not provide decode down to the word or byte level
1	Reserved
0	Generic Decode Range 1 Enable (GEN1_EN) — R/W. 0 = Disable. 1 = Enable the GEN1 I/O range to be forwarded to the LPC I/F

13.1.24 GEN2_DEC—LPC I/F Generic Decode Range 2 Register (LPC I/F—D31:F0)

Offset Address: 88h–8Bh
Default Value: 00000000h

Attribute: R/W
Size: 32 bit
Power Well: Core

Bit	Description
31:24	Reserved
23:18	Generic I/O Decode Range Address[7:2] Mask — R/W. A 1 in any bit position indicates that any value in the corresponding address bit in a received cycle will be treated as a match. The corresponding bit in the Address field, below, is ignored. The mask is only provided for the lower 6 bits of the DWord address, allowing for decoding blocks up to 256 bytes in size.
17:16	Reserved
15:2	Generic I/O Decode Range 2 Base Address (GEN1_BASE) — R/W. NOTE: The PCH does not provide decode down to the word or byte level.
1	Reserved
0	Generic Decode Range 2 Enable (GEN2_EN) — R/W. 0 = Disable. 1 = Enable the GEN2 I/O range to be forwarded to the LPC I/F



13.1.25 GEN3_DEC—LPC I/F Generic Decode Range 3 Register (LPC I/F—D31:F0)

Offset Address: 8Ch-8Eh
Default Value: 00000000h

Attribute: R/W
Size: 32 bit
Power Well: Core

Bit	Description
31:24	Reserved
23:18	Generic I/O Decode Range Address[7:2] Mask — R/W. A 1 in any bit position indicates that any value in the corresponding address bit in a received cycle will be treated as a match. The corresponding bit in the Address field, below, is ignored. The mask is only provided for the lower 6 bits of the DWord address, allowing for decoding blocks up to 256 bytes in size.
17:16	Reserved
15:2	Generic I/O Decode Range 3 Base Address (GEN3_BASE) — R/W. NOTE: The PCH Does not provide decode down to the word or byte level
1	Reserved
0	Generic Decode Range 3 Enable (GEN3_EN) — R/W. 0 = Disable. 1 = Enable the GEN3 I/O range to be forwarded to the LPC I/F

13.1.26 GEN4_DEC—LPC I/F Generic Decode Range 4 Register (LPC I/F—D31:F0)

Offset Address: 90h-93h
Default Value: 00000000h

Attribute: R/W
Size: 32 bit
Power Well: Core

Bit	Description
31:24	Reserved
23:18	Generic I/O Decode Range Address[7:2] Mask — R/W. A 1 in any bit position indicates that any value in the corresponding address bit in a received cycle will be treated as a match. The corresponding bit in the Address field, below, is ignored. The mask is only provided for the lower 6 bits of the DWord address, allowing for decoding blocks up to 256 bytes in size.
17:16	Reserved
15:2	Generic I/O Decode Range 4 Base Address (GEN4_BASE) — R/W. NOTE: The PCH Does not provide decode down to the word or byte level
1	Reserved
0	Generic Decode Range 4 Enable (GEN4_EN) — R/W. 0 = Disable. 1 = Enable the GEN4 I/O range to be forwarded to the LPC I/F



13.1.27 ULKMC – USB Legacy Keyboard / Mouse Control Register (LPC I/F–D31:F0)

Offset Address: 94h–97h
Default Value: 00002000h

Attribute: RO, R/WC, R/W
Size: 32 bit
Power Well: Core

Bit	Description
31:16	Reserved
15	<p>SMI Caused by End of Pass-Through (SMIBYENDPS) – R/WC. This bit indicates if the event occurred. Note that even if the corresponding enable bit is not set in bit 7, then this bit will still be active. It is up to the SMM code to use the enable bit to determine the exact cause of the SMI#.</p> <p>0 = Software clears this bit by writing a 1 to the bit location in any of the controllers. 1 = Event Occurred</p>
14:12	Reserved
11	<p>SMI Caused by Port 64 Write (TRAPBY64W) – R/WC. This bit indicates if the event occurred. Note that even if the corresponding enable bit is not set in bit 3, this bit will still be active. It is up to the SMM code to use the enable bit to determine the exact cause of the SMI#. Note that the A20Gate Pass-Through Logic allows specific port 64h writes to complete without setting this bit.</p> <p>0 = Software clears this bit by writing a 1 to the bit location in any of the controllers. 1 = Event Occurred.</p>
10	<p>SMI Caused by Port 64 Read (TRAPBY64R) – R/WC. This bit indicates if the event occurred. Note that even if the corresponding enable bit is not set in bit 2, this bit will still be active. It is up to the SMM code to use the enable bit to determine the exact cause of the SMI#.</p> <p>0 = Software clears this bit by writing a 1 to the bit location in any of the controllers. 1 = Event Occurred.</p>
9	<p>SMI Caused by Port 60 Write (TRAPBY60W) – R/WC. This bit indicates if the event occurred. Note that even if the corresponding enable bit is not set in bit 1, this bit will still be active. It is up to the SMM code to use the enable bit to determine the exact cause of the SMI#. Note that the A20Gate Pass-Through Logic allows specific port 64h writes to complete without setting this bit.</p> <p>0 = Software clears this bit by writing a 1 to the bit location in any of the controllers. 1 = Event Occurred.</p>
8	<p>SMI Caused by Port 60 Read (TRAPBY60R) – R/WC. This bit indicates if the event occurred. Note that even if the corresponding enable bit is not set in the bit 0, then this bit will still be active. It is up to the SMM code to use the enable bit to determine the exact cause of the SMI#.</p> <p>0 = Software clears this bit by writing a 1 to the bit location in any of the controllers. 1 = Event Occurred.</p>
7	<p>SMI at End of Pass-Through Enable (SMIATENDPS) – R/W. This bit enables SMI at the end of a pass-through. This can occur if an SMI is generated in the middle of a pass-through, and needs to be serviced later.</p> <p>0 = Disable 1 = Enable</p>
6	<p>Pass Through State (PSTATE) – RO.</p> <p>0 = If software needs to reset this bit, it should set bit 5 in all of the host controllers to 0. 1 = Indicates that the state machine is in the middle of an A20GATE pass-through sequence.</p>



Bit	Description
5	A20Gate Pass-Through Enable (A20PASSEN) — R/W. 0 = Disable. 1 = Enable. Allows A20GATE sequence Pass-Through function. A specific cycle sequence involving writes to port 60h and 64h does not result in the setting of the SMI status bits.
4	SMI on USB IRQ Enable (USBSMIEN) — R/W. 0 = Disable 1 = Enable. USB interrupt will cause an SMI event.
3	SMI on Port 64 Writes Enable (64WEN) — R/W. 0 = Disable 1 = Enable. A 1 in bit 11 will cause an SMI event.
2	SMI on Port 64 Reads Enable (64REN) — R/W. 0 = Disable 1 = Enable. A 1 in bit 10 will cause an SMI event.
1	SMI on Port 60 Writes Enable (60WEN) — R/W. 0 = Disable 1 = Enable. A 1 in bit 9 will cause an SMI event.
0	SMI on Port 60 Reads Enable (60REN) — R/W. 0 = Disable 1 = Enable. A 1 in bit 8 will cause an SMI event.

13.1.28 LGMR — LPC I/F Generic Memory Range Register (LPC I/F—D31:F0)

Offset Address: 98h–9Bh
Default Value: 00000000h

Attribute: R/W
Size: 32 bit
Power Well: Core

Bit	Description
31:16	Memory Address[31:16] — R/W. This field specifies a 64 KB memory block anywhere in the 4 GB memory space that will be decoded to LPC as standard LPC memory cycle if enabled.
15:1	Reserved
0	LPC Memory Range Decode Enable — R/W. When this bit is set to 1, then the range specified in bits 31:16 of this register is enabled for decoding to LPC.



13.1.29 BIOS_SEL1—BIOS Select 1 Register (LPC I/F—D31:F0)

Offset Address: D0h–D3h
Default Value: 00112233h

Attribute: R/W, RO
Size: 32 bits

Bit	Description
31:28	BIOS_F8_IDSEL — RO. IDSEL for two 512-KB BIOS memory ranges and one 128-KB memory range. This field is fixed at 0000. The IDSEL programmed in this field addresses the following memory ranges: FFF8 0000h–FFFF FFFFh FFB8 0000h–FFBF FFFFh 000E 0000h–000F FFFFh
27:24	BIOS_F0_IDSEL — R/W. IDSEL for two 512-KB BIOS memory ranges. The IDSEL programmed in this field addresses the following memory ranges: FFF0 0000h–FFF7 FFFFh FFB0 0000h–FFB7 FFFFh
23:20	BIOS_E8_IDSEL — R/W. IDSEL for two 512-KB BIOS memory ranges. The IDSEL programmed in this field addresses the following memory ranges: FFE8 0000h–FFE7 FFFFh FFA8 0000h–FFAF FFFFh
19:16	BIOS_E0_IDSEL — R/W. IDSEL for two 512-KB BIOS memory ranges. The IDSEL programmed in this field addresses the following memory ranges: FFE0 0000h–FFE7 FFFFh FFA0 0000h–FFA7 FFFFh
15:12	BIOS_D8_IDSEL — R/W. IDSEL for two 512-KB BIOS memory ranges. The IDSEL programmed in this field addresses the following memory ranges: FFD8 0000h–FFDF FFFFh FF98 0000h–FF9F FFFFh
11:8	BIOS_D0_IDSEL — R/W. IDSEL for two 512-KB BIOS memory ranges. The IDSEL programmed in this field addresses the following memory ranges: FFD0 0000h–FFD7 FFFFh FF90 0000h–FF97 FFFFh
7:4	BIOS_C8_IDSEL — R/W. IDSEL for two 512-KB BIOS memory ranges. The IDSEL programmed in this field addresses the following memory ranges: FFC8 0000h–FFCF FFFFh FF88 0000h–FF8F FFFFh
3:0	BIOS_C0_IDSEL — R/W. IDSEL for two 512-KB BIOS memory ranges. The IDSEL programmed in this field addresses the following memory ranges: FFC0 0000h–FFC7 FFFFh FF80 0000h–FF87 FFFFh



13.1.30 BIOS_SEL2—BIOS Select 2 Register (LPC I/F—D31:F0)

Offset Address: D4h–D5h
Default Value: 4567h

Attribute: R/W
Size: 16 bits

Bit	Description
15:12	BIOS_70_IDSEL — R/W. IDSEL for two, 1-M BIOS memory ranges. The IDSEL programmed in this field addresses the following memory ranges: FF70 0000h–FF7F FFFFh FF30 0000h–FF3F FFFFh
11:8	BIOS_60_IDSEL — R/W. IDSEL for two, 1-M BIOS memory ranges. The IDSEL programmed in this field addresses the following memory ranges: FF60 0000h–FF6F FFFFh FF20 0000h–FF2F FFFFh
7:4	BIOS_50_IDSEL — R/W. IDSEL for two, 1-M BIOS memory ranges. The IDSEL programmed in this field addresses the following memory ranges: FF50 0000h–FF5F FFFFh FF10 0000h–FF1F FFFFh
3:0	BIOS_40_IDSEL — R/W. IDSEL for two, 1-M BIOS memory ranges. The IDSEL programmed in this field addresses the following memory ranges: FF40 0000h–FF4F FFFFh FF00 0000h–FF0F FFFFh



13.1.31 BIOS_DEC_EN1—BIOS Decode Enable Register (LPC I/F—D31:F0)

Offset Address: D8h–D9h
Default Value: FFCFh

Attribute: R/W, RO
Size: 16 bits

Bit	Description
15	BIOS_F8_EN — RO. This bit enables decoding two 512-KB BIOS memory ranges, and one 128-KB memory range. 0 = Disable 1 = Enable the following ranges for the BIOS FFF80000h–FFFFFFFFh FFB80000h–FFBFFFFh
14	BIOS_F0_EN — R/W. This bit enables decoding two 512-KB BIOS memory ranges. 0 = Disable. 1 = Enable the following ranges for the BIOS: FFF00000h–FFF7FFFFh FFB00000h–FFB7FFFFh
13	BIOS_E8_EN — R/W. This bit enables decoding two 512-KB BIOS memory ranges. 0 = Disable. 1 = Enable the following ranges for the BIOS: FFE80000h–FFEFFFFh FFA80000h–FFAFFFFh
12	BIOS_E0_EN — R/W. This bit enables decoding two 512-KB BIOS memory ranges. 0 = Disable. 1 = Enable the following ranges for the BIOS: FFE00000h–FFE7FFFFh FFA00000h–FFA7FFFFh
11	BIOS_D8_EN — R/W. This bit enables decoding two 512-KB BIOS memory ranges. 0 = Disable. 1 = Enable the following ranges for the BIOS FFD80000h–FFDFFFFh FF980000h–FF9FFFFh
10	BIOS_D0_EN — R/W. This bit enables decoding two 512-KB BIOS memory ranges. 0 = Disable. 1 = Enable the following ranges for the BIOS FFD00000h–FFD7FFFFh FF900000h–FF97FFFFh
9	BIOS_C8_EN — R/W. This bit enables decoding two 512-KB BIOS memory ranges. 0 = Disable. 1 = Enable the following ranges for the BIOS FFC80000h–FFCFFFFh FF880000h–FF8FFFFh
8	BIOS_C0_EN — R/W. This bit enables decoding two 512-KB BIOS memory ranges. 0 = Disable. 1 = Enable the following ranges for the BIOS FFC00000h–FFC7FFFFh FF800000h–FF87FFFFh



Bit	Description
7	<p>BIOS_Legacy_F_EN — R/W. This enables the decoding of the legacy 64KB range at F0000h–FFFFFh.</p> <p>0 = Disable. 1 = Enable the following legacy ranges for the BIOS F0000h–FFFFFh</p> <p>NOTE: The decode for the BIOS legacy F segment is enabled only by this bit and is not affected by the GEN_PMCON_1.iA64_EN bit.</p>
6	<p>BIOS_Legacy_E_EN — R/W. This enables the decoding of the legacy 64KB range at E0000h–FFFFFh.</p> <p>0 = Disable. 1 = Enable the following legacy ranges for the BIOS E0000h–FFFFFh</p> <p>NOTE: The decode for the BIOS legacy E segment is enabled only by this bit and is not affected by the GEN_PMCON_1.iA64_EN bit.</p>
5:4	Reserved
3	<p>BIOS_70_EN — R/W. Enables decoding two 1-M BIOS memory ranges.</p> <p>0 = Disable. 1 = Enable the following ranges for the BIOS FF70 0000h–FF7F FFFFh FF30 0000h–FF3F FFFFh</p>
2	<p>BIOS_60_EN — R/W. Enables decoding two 1-M BIOS memory ranges.</p> <p>0 = Disable. 1 = Enable the following ranges for the BIOS FF60 0000h–FF6F FFFFh FF20 0000h–FF2F FFFFh</p>
1	<p>BIOS_50_EN — R/W. Enables decoding two 1-M BIOS memory ranges.</p> <p>0 = Disable. 1 = Enable the following ranges for the BIOS FF50 0000h–FF5F FFFFh FF10 0000h–FF1F FFFFh</p>
0	<p>BIOS_40_EN — R/W. Enables decoding two 1-M BIOS memory ranges.</p> <p>0 = Disable. 1 = Enable the following ranges for the BIOS FF40 0000h–FF4F FFFFh FF00 0000h–FF0F FFFFh</p>

NOTE: This register effects the BIOS decode regardless of whether the BIOS is resident on LPC or SPI. The concept of Feature Space does not apply to SPI-based flash. The PCH simply decodes these ranges as memory accesses when enabled for the SPI flash interface.



13.1.33 FDCAP—Feature Detection Capability ID Register (LPC I/F—D31:F0)

Offset Address: E0h–E1h Attribute: RO
Default Value: 0009h Size: 16 bit
Power Well: Core

Bit	Description
15:8	Next Item Pointer (NEXT) — RO. Configuration offset of the next Capability Item. 00h indicates the last item in the Capability List.
7:0	Capability ID — RO. Indicates a Vendor Specific Capability

13.1.34 FDLEN—Feature Detection Capability Length Register (LPC I/F—D31:F0)

Offset Address: E2h Attribute: RO
Default Value: 0Ch Size: 8 bit
Power Well: Core

Bit	Description
7:0	Capability Length — RO. Indicates the length of this Vendor Specific capability, as required by PCI Specification.

13.1.35 FDVER—Feature Detection Version Register (LPC I/F—D31:F0)

Offset Address: E3h Attribute: RO
Default Value: 10h Size: 8 bit
Power Well: Core

Bit	Description
7:4	Vendor-Specific Capability ID — RO. A value of 1h in this 4-bit field identifies this Capability as Feature Detection Type. This field allows software to differentiate the Feature Detection Capability from other Vendor-Specific capabilities
3:0	Capability Version — RO. This field indicates the version of the Feature Detection capability

13.1.36 FVECIDX—Feature Vector Index Register (LPC I/F—D31:F0)

Offset Address: E4h–E7h Attribute: R/W
Default Value: 00000000h Size: 32 bit
Power Well: Core

Bit	Description
31:6	Reserved
5:2	Index (IDX) — R/W. 4-bit index pointer into the 64-byte Feature Vector space. Data is read from the FVECD register. This points to a DWord register.
1:0	Reserved

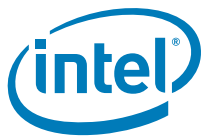

13.2 DMA I/O Registers

Table 13-2. DMA Registers (Sheet 1 of 2)

Port	Alias	Register Name	Default	Type
00h	10h	Channel 0 DMA Base and Current Address	Undefined	R/W
01h	11h	Channel 0 DMA Base and Current Count	Undefined	R/W
02h	12h	Channel 1 DMA Base and Current Address	Undefined	R/W
03h	13h	Channel 1 DMA Base and Current Count	Undefined	R/W
04h	14h	Channel 2 DMA Base and Current Address	Undefined	R/W
05h	15h	Channel 2 DMA Base and Current Count	Undefined	R/W
06h	16h	Channel 3 DMA Base and Current Address	Undefined	R/W
07h	17h	Channel 3 DMA Base and Current Count	Undefined	R/W
08h	18h	Channel 0–3 DMA Command	Undefined	WO
		Channel 0–3 DMA Status	Undefined	RO
0Ah	1Ah	Channel 0–3 DMA Write Single Mask	000001XXb	WO
0Bh	1Bh	Channel 0–3 DMA Channel Mode	000000XXb	WO
0Ch	1Ch	Channel 0–3 DMA Clear Byte Pointer	Undefined	WO
0Dh	1Dh	Channel 0–3 DMA Master Clear	Undefined	WO
0Eh	1Eh	Channel 0–3 DMA Clear Mask	Undefined	WO
0Fh	1Fh	Channel 0–3 DMA Write All Mask	0Fh	R/W
80h	90h	Reserved Page	Undefined	R/W
81h	91h	Channel 2 DMA Memory Low Page	Undefined	R/W
82h	—	Channel 3 DMA Memory Low Page	Undefined	R/W
83h	93h	Channel 1 DMA Memory Low Page	Undefined	R/W
84h–86h	94h–96h	Reserved Pages	Undefined	R/W
87h	97h	Channel 0 DMA Memory Low Page	Undefined	R/W
88h	98h	Reserved Page	Undefined	R/W
89h	99h	Channel 6 DMA Memory Low Page	Undefined	R/W
8Ah	9Ah	Channel 7 DMA Memory Low Page	Undefined	R/W
8Bh	9Bh	Channel 5 DMA Memory Low Page	Undefined	R/W
8Ch–8Eh	9Ch–9Eh	Reserved Page	Undefined	R/W
8Fh	9Fh	Refresh Low Page	Undefined	R/W
C0h	C1h	Channel 4 DMA Base and Current Address	Undefined	R/W
C2h	C3h	Channel 4 DMA Base and Current Count	Undefined	R/W
C4h	C5h	Channel 5 DMA Base and Current Address	Undefined	R/W
C6h	C7h	Channel 5 DMA Base and Current Count	Undefined	R/W
C8h	C9h	Channel 6 DMA Base and Current Address	Undefined	R/W
CAh	CBh	Channel 6 DMA Base and Current Count	Undefined	R/W
CCh	CDh	Channel 7 DMA Base and Current Address	Undefined	R/W
CEh	CFh	Channel 7 DMA Base and Current Count	Undefined	R/W



Table 13-2. DMA Registers (Sheet 2 of 2)

Port	Alias	Register Name	Default	Type
D0h	D1h	Channel 4–7 DMA Command	Undefined	WO
		Channel 4–7 DMA Status	Undefined	RO
D4h	D5h	Channel 4–7 DMA Write Single Mask	000001XXb	WO
D6h	D7h	Channel 4–7 DMA Channel Mode	000000XXb	WO
D8h	D9h	Channel 4–7 DMA Clear Byte Pointer	Undefined	WO
DAh	DBh	Channel 4–7 DMA Master Clear	Undefined	WO
DCh	DDh	Channel 4–7 DMA Clear Mask	Undefined	WO
DEh	DFh	Channel 4–7 DMA Write All Mask	0Fh	R/W

13.2.1 DMABASE_CA—DMA Base and Current Address Registers

I/O Address: Ch. #0 = 00h; Ch. #1 = 02h Attribute: R/W
 Ch. #2 = 04h; Ch. #3 = 06h Size: 16 bit (per channel),
 Ch. #5 = C4h Ch. #6 = C8h but accessed in two 8-bit
 Ch. #7 = CCh; quantities
 Default Value: Undefined
 Lockable: No Power Well: Core

Bit	Description
15:0	<p>Base and Current Address — R/W. This register determines the address for the transfers to be performed. The address specified points to two separate registers. On writes, the value is stored in the <i>Base Address</i> register and copied to the <i>Current Address</i> register. On reads, the value is returned from the <i>Current Address</i> register. The address increments/decrements in the Current Address register after each transfer, depending on the mode of the transfer. If the channel is in auto-initialize mode, the Current Address register will be reloaded from the Base Address register after a terminal count is generated.</p> <p>For transfers to/from a 16-bit slave (channels 5–7), the address is shifted left one bit location. Bit 15 will be shifted into Bit 16.</p> <p>The register is accessed in 8 bit quantities. The byte is pointed to by the current byte pointer flip/flop. Before accessing an address register, the byte pointer flip/flop should be cleared to ensure that the low byte is accessed first.</p>



13.2.2 DMABASE_CC—DMA Base and Current Count Registers

I/O Address: Ch. #0 = 01h; Ch. #1 = 03h Attribute: R/W
 Ch. #2 = 05h; Ch. #3 = 07h Size: 16-bit (per channel),
 Ch. #5 = C6h; Ch. #6 = CAh but accessed in two 8-bit
 Ch. #7 = CEh; quantities
 Default Value: Undefined
 Lockable: No Power Well:Core

Bit	Description
15:0	<p>Base and Current Count — R/W. This register determines the number of transfers to be performed. The address specified points to two separate registers. On writes, the value is stored in the <i>Base Count</i> register and copied to the <i>Current Count</i> register. On reads, the value is returned from the <i>Current Count</i> register.</p> <p>The actual number of transfers is one more than the number programmed in the Base Count Register (that is, programming a count of 4h results in 5 transfers). The count is decrements in the Current Count register after each transfer. When the value in the register rolls from 0 to FFFFh, a terminal count is generated. If the channel is in auto-initialize mode, the Current Count register will be reloaded from the Base Count register after a terminal count is generated.</p> <p>For transfers to/from an 8-bit slave (channels 0–3), the count register indicates the number of bytes to be transferred. For transfers to/from a 16-bit slave (channels 5–7), the count register indicates the number of words to be transferred.</p> <p>The register is accessed in 8 bit quantities. The byte is pointed to by the current byte pointer flip/flop. Before accessing a count register, the byte pointer flip/flop should be cleared to ensure that the low byte is accessed first.</p>

13.2.3 DMAMEM_LP—DMA Memory Low Page Registers

I/O Address: Ch. #0 = 87h; Ch. #1 = 83h
 Ch. #2 = 81h; Ch. #3 = 82h
 Ch. #5 = 8Bh; Ch. #6 = 89h
 Ch. #7 = 8Ah; Attribute: R/W
 Default Value: Undefined Size: 8-bit
 Lockable: No Power Well: Core

Bit	Description
7:0	<p>DMA Low Page (ISA Address bits [23:16]) — R/W. This register works in conjunction with the DMA controller's Current Address Register to define the complete 24-bit address for the DMA channel. This register remains static throughout the DMA transfer. Bit 16 of this register is ignored when in 16 bit I/O count by words mode as it is replaced by the bit 15 shifted out from the current address register.</p>



13.2.4 DMACMD—DMA Command Register

I/O Address: Ch. #0–3 = 08h;
 Ch. #4–7 = D0h
 Attribute: WO
 Default Value: Undefined
 Size: 8-bit
 Lockable: No
 Power Well: Core

Bit	Description
7:5	Reserved. Must be 0.
4	DMA Group Arbitration Priority — WO. Each channel group is individually assigned either fixed or rotating arbitration priority. At part reset, each group is initialized in fixed priority. 0 = Fixed priority to the channel group 1 = Rotating priority to the group.
3	Reserved. Must be 0.
2	DMA Channel Group Enable — WO. Both channel groups are enabled following part reset. 0 = Enable the DMA channel group. 1 = Disable. Disabling channel group 4–7 also disables channel group 0–3, which is cascaded through channel 4.
1:0	Reserved. Must be 0.

13.2.5 DMASTA—DMA Status Register

I/O Address: Ch. #0–3 = 08h;
 Ch. #4–7 = D0h
 Attribute: RO
 Default Value: Undefined
 Size: 8-bit
 Lockable: No
 Power Well: Core

Bit	Description
7:4	Channel Request Status — RO. When a valid DMA request is pending for a channel, the corresponding bit is set to 1. When a DMA request is not pending for a particular channel, the corresponding bit is set to 0. The source of the DREQ may be hardware or a software request. Note that channel 4 is the cascade channel, so the request status of channel 4 is a logical OR of the request status for channels 0 through 3. 4 = Channel 0 5 = Channel 1 (5) 6 = Channel 2 (6) 7 = Channel 3 (7)
3:0	Channel Terminal Count Status — RO. When a channel reaches terminal count (TC), its status bit is set to 1. If TC has not been reached, the status bit is set to 0. Channel 4 is programmed for cascade, so the TC bit response for channel 4 is irrelevant: 0 = Channel 0 1 = Channel 1 (5) 2 = Channel 2 (6) 3 = Channel 3 (7)



13.2.6 DMA_WRSMSK—DMA Write Single Mask Register

I/O Address: Ch. #0-3 = 0Ah;
 Ch. #4-7 = D4h Attribute: WO
 Default Value: 0000 01xx Size: 8-bit
 Lockable: No Power Well: Core

Bit	Description
7:3	Reserved. Must be 0.
2	Channel Mask Select — WO. 0 = Enable DREQ for the selected channel. The channel is selected through bits [1:0]. Therefore, only one channel can be masked / unmasked at a time. 1 = Disable DREQ for the selected channel.
1:0	DMA Channel Select — WO. These bits select the DMA Channel Mode Register to program. 00 = Channel 0 (4) 01 = Channel 1 (5) 10 = Channel 2 (6) 11 = Channel 3 (7)

13.2.7 DMACH_MODE—DMA Channel Mode Register

I/O Address: Ch. #0-3 = 0Bh;
 Ch. #4-7 = D6h Attribute: WO
 Default Value: 0000 00xx Size: 8-bit
 Lockable: No Power Well: Core

Bit	Description
7:6	DMA Transfer Mode — WO. Each DMA channel can be programmed in one of four different modes: 00 = Demand mode 01 = Single mode 10 = Reserved 11 = Cascade mode
5	Address Increment/Decrement Select — WO. This bit controls address increment/decrement during DMA transfers. 0 = Address increment. (default after part reset or Master Clear) 1 = Address decrement.
4	Autoinitialize Enable — WO. 0 = Autoinitialize feature is disabled and DMA transfers terminate on a terminal count. A part reset or Master Clear disables autoinitialization. 1 = DMA restores the Base Address and Count registers to the current registers following a terminal count (TC).
3:2	DMA Transfer Type — WO. These bits represent the direction of the DMA transfer. When the channel is programmed for cascade mode, (bits[7:6] = 11) the transfer type is irrelevant. 00 = Verify - No I/O or memory strobes generated 01 = Write - Data transferred from the I/O devices to memory 10 = Read - Data transferred from memory to the I/O device 11 = Invalid
1:0	DMA Channel Select — WO. These bits select the DMA Channel Mode Register that will be written by bits [7:2]. 00 = Channel 0 (4) 01 = Channel 1 (5) 10 = Channel 2 (6) 11 = Channel 3 (7)



13.2.8 DMA Clear Byte Pointer Register

I/O Address: Ch. #0–3 = 0Ch;
 Ch. #4–7 = D8h
 Attribute: WO
 Default Value: xxxx xxxx
 Size: 8-bit
 Lockable: No
 Power Well: Core

Bit	Description
7:0	Clear Byte Pointer — WO. No specific pattern. Command enabled with a write to the I/O port address. Writing to this register initializes the byte pointer flip/flop to a known state. It clears the internal latch used to address the upper or lower byte of the 16-bit Address and Word Count Registers. The latch is also cleared by part reset and by the Master Clear command. This command precedes the first access to a 16-bit DMA controller register. The first access to a 16-bit register will then access the significant byte, and the second access automatically accesses the most significant byte.

13.2.9 DMA Master Clear Register

I/O Address: Ch. #0–3 = 0Dh;
 Ch. #4–7 = DAh
 Attribute: WO
 Default Value: xxxx xxxx
 Size: 8-bit

Bit	Description
7:0	Master Clear — WO. No specific pattern. Enabled with a write to the port. This has the same effect as the hardware Reset. The Command, Status, Request, and Byte Pointer flip/flop registers are cleared and the Mask Register is set.

13.2.10 DMA_CLMSK—DMA Clear Mask Register

I/O Address: Ch. #0–3 = 0Eh;
 Ch. #4–7 = DCh
 Attribute: WO
 Default Value: xxxx xxxx
 Size: 8-bit
 Lockable: No
 Power Well: Core

Bit	Description
7:0	Clear Mask Register — WO. No specific pattern. Command enabled with a write to the port.



13.2.11 DMA_WRMSK—DMA Write All Mask Register

I/O Address: Ch. #0-3 = 0Fh;
 Ch. #4-7 = DEh
 Attribute: R/W
 Default Value: 0000 1111
 Size: 8-bit
 Lockable: No
 Power Well: Core

Bit	Description
7:4	Reserved. Must be 0.
3:0	<p>Channel Mask Bits — R/W. This register permits all four channels to be simultaneously enabled/disabled instead of enabling/disabling each channel individually, as is the case with the Mask Register – Write Single Mask Bit. In addition, this register has a read path to allow the status of the channel mask bits to be read. A channel's mask bit is automatically set to 1 when the Current Byte/Word Count Register reaches terminal count (unless the channel is in auto-initialization mode).</p> <p>Setting the bit(s) to a 1 disables the corresponding DREQ(s). Setting the bit(s) to a 0 enables the corresponding DREQ(s). Bits [3:0] are set to 1 upon part reset or Master Clear. When read, bits [3:0] indicate the DMA channel [3:0] ([7:4]) mask status.</p> <p>Bit 0 = Channel 0 (4)1 = Masked, 0 = Not Masked Bit 1 = Channel 1 (5)1 = Masked, 0 = Not Masked Bit 2 = Channel 2 (6)1 = Masked, 0 = Not Masked Bit 3 = Channel 3 (7)1 = Masked, 0 = Not Masked</p> <p>NOTE: Disabling channel 4 also disables channels 0-3 due to the cascade of channels 0-3 through channel 4.</p>

13.3 Timer I/O Registers

Port	Aliases	Register Name	Default Value	Type
40h	50h	Counter 0 Interval Time Status Byte Format	0XXXXXXXXb	RO
		Counter 0 Counter Access Port	Undefined	R/W
41h	51h	Counter 1 Interval Time Status Byte Format	0XXXXXXXXb	RO
		Counter 1 Counter Access Port	Undefined	R/W
42h	52h	Counter 2 Interval Time Status Byte Format	0XXXXXXXXb	RO
		Counter 2 Counter Access Port	Undefined	R/W
43h	53h	Timer Control Word	Undefined	WO
		Timer Control Word Register	XXXXXXXX0b	WO
		Counter Latch Command	X0h	WO

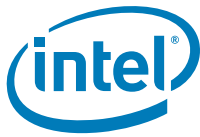

RDBK_CMD—Read Back Command

The Read Back Command is used to determine the count value, programmed mode, and current states of the OUT pin and Null count flag of the selected counter or counters. Status and/or count may be latched in any or all of the counters by selecting the counter during the register write. The count and status remain latched until read, and further latch commands are ignored until the count is read. Both count and status of the selected counters may be latched simultaneously by setting both bit 5 and bit 4 to 0. If both are latched, the first read operation from that counter returns the latched status. The next one or two reads, depending on whether the counter is programmed for one or two byte counts, returns the latched count. Subsequent reads return an unlatched count.

Bit	Description
7:6	Read Back Command. Must be 11 to select the Read Back Command
5	Latch Count of Selected Counters. 0 = Current count value of the selected counters will be latched 1 = Current count will not be latched
4	Latch Status of Selected Counters. 0 = Status of the selected counters will be latched 1 = Status will not be latched
3	Counter 2 Select. 1 = Counter 2 count and/or status will be latched
2	Counter 1 Select. 1 = Counter 1 count and/or status will be latched
1	Counter 0 Select. 1 = Counter 0 count and/or status will be latched.
0	Reserved. Must be 0.

LTCH_CMD—Counter Latch Command

The Counter Latch Command latches the current count value. This command is used to insure that the count read from the counter is accurate. The count value is then read from each counter's count register through the Counter Ports Access Ports Register (40h for counter 0, 41h for counter 1, and 42h for counter 2). The count must be read according to the programmed format; that is, if the counter is programmed for two byte counts, two bytes must be read. The two bytes do not have to be read one right after the other (read, write, or programming operations for other counters may be inserted between the reads). If a counter is latched once and then latched again before the count is read, the second Counter Latch Command is ignored.

Bit	Description
7:6	Counter Selection. These bits select the counter for latching. If "11" is written, then the write is interpreted as a read back command. 00 = Counter 0 01 = Counter 1 10 = Counter 2
5:4	Counter Latch Command. 00 = Selects the Counter Latch Command.
3:0	Reserved. Must be 0.



13.3.2 SBYTE_FMT—Interval Timer Status Byte Format Register

I/O Address: Counter 0 = 40h,
 Counter 1 = 41h, Attribute: RO
 Counter 2 = 42h Size: 8 bits per counter
 Default Value: Bits[6:0] undefined, Bit 7=0

Each counter's status byte can be read following a Read Back Command. If latch status is chosen (bit 4=0, Read Back Command) as a read back option for a given counter, the next read from the counter's Counter Access Ports Register (40h for counter 0, 41h for counter 1, and 42h for counter 2) returns the status byte. The status byte returns the following:

Bit	Description
7	Counter OUT Pin State — RO. 0 = OUT pin of the counter is also a 0 1 = OUT pin of the counter is also a 1
6	Count Register Status — RO. This bit indicates when the last count written to the Count Register (CR) has been loaded into the counting element (CE). The exact time this happens depends on the counter mode, but until the count is loaded into the counting element (CE), the count value will be incorrect. 0 = Count has been transferred from CR to CE and is available for reading. 1 = Null Count. Count has not been transferred from CR to CE and is not yet available for reading.
5:4	Read/Write Selection Status — RO. These reflect the read/write selection made through bits[5:4] of the control register. The binary codes returned during the status read match the codes used to program the counter read/write selection. 00 = Counter Latch Command 01 = Read/Write Least Significant Byte (LSB) 10 = Read/Write Most Significant Byte (MSB) 11 = Read/Write LSB then MSB
3:1	Mode Selection Status — RO. These bits return the counter mode programming. The binary code returned matches the code used to program the counter mode, as listed under the bit function above. 000 = Mode 0 — Out signal on end of count (=0) 001 = Mode 1 — Hardware retriggerable one-shot x10 = Mode 2 — Rate generator (divide by n counter) x11 = Mode 3 — Square wave output 100 = Mode 4 — Software triggered strobe 101 = Mode 5 — Hardware triggered strobe
0	Countdown Type Status — RO. This bit reflects the current countdown type. 0 = Binary countdown 1 = Binary Coded Decimal (BCD) countdown.



13.4.2 ICW1—Initialization Command Word 1 Register

Offset Address: Master Controller – 20h Attribute: WO
 Slave Controller – A0h Size: 8 bit /controller
 Default Value: All bits undefined

A write to Initialization Command Word 1 starts the interrupt controller initialization sequence, during which the following occurs:

1. The Interrupt Mask register is cleared.
2. IRQ7 input is assigned priority 7.
3. The slave mode address is set to 7.
4. Special mask mode is cleared and Status Read is set to IRR.

Once this write occurs, the controller expects writes to ICW2, ICW3, and ICW4 to complete the initialization sequence.

Bit	Description
7:5	ICW/OCW Select — WO. These bits are MCS-85 specific, and not needed. 000 = Should be programmed to "000"
4	ICW/OCW Select — WO. 1 = This bit must be a 1 to select ICW1 and enable the ICW2, ICW3, and ICW4 sequence.
3	Edge/Level Bank Select (LTIM) — WO. Disabled. Replaced by the edge/level triggered control registers (ELCR, D31:F0:4D0h, D31:F0:4D1h).
2	ADI — WO. 0 = Ignored for the PCH. Should be programmed to 0.
1	Single or Cascade (SNGL) — WO. 0 = Must be programmed to a 0 to indicate two controllers operating in cascade mode.
0	ICW4 Write Required (IC4) — WO. 1 = This bit must be programmed to a 1 to indicate that ICW4 needs to be programmed.

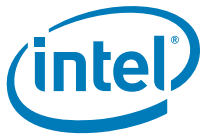

13.4.3 ICW2—Initialization Command Word 2 Register

Offset Address: Master Controller – 21h Attribute: WO
 Slave Controller – A1h Size: 8 bit /controller
 Default Value: All bits undefined

ICW2 is used to initialize the interrupt controller with the five most significant bits of the interrupt vector address. The value programmed for bits[7:3] is used by the processor to define the base address in the interrupt vector table for the interrupt routines associated with each IRQ on the controller. Typical ISA ICW2 values are 08h for the master controller and 70h for the slave controller.

Bit	Description																											
7:3	Interrupt Vector Base Address — WO. Bits [7:3] define the base address in the interrupt vector table for the interrupt routines associated with each interrupt request level input.																											
2:0	<p>Interrupt Request Level — WO. When writing ICW2, these bits should all be 0. During an interrupt acknowledge cycle, these bits are programmed by the interrupt controller with the interrupt to be serviced. This is combined with bits [7:3] to form the interrupt vector driven onto the data bus during the second INTA# cycle. The code is a three bit binary code:</p> <table border="1"> <thead> <tr> <th>Code</th> <th>Master Interrupt</th> <th>Slave Interrupt</th> </tr> </thead> <tbody> <tr><td>000b</td><td>IRQ0</td><td>IRQ8</td></tr> <tr><td>001b</td><td>IRQ1</td><td>IRQ9</td></tr> <tr><td>010b</td><td>IRQ2</td><td>IRQ10</td></tr> <tr><td>011b</td><td>IRQ3</td><td>IRQ11</td></tr> <tr><td>100b</td><td>IRQ4</td><td>IRQ12</td></tr> <tr><td>101b</td><td>IRQ5</td><td>IRQ13</td></tr> <tr><td>110b</td><td>IRQ6</td><td>IRQ14</td></tr> <tr><td>111b</td><td>IRQ7</td><td>IRQ15</td></tr> </tbody> </table>	Code	Master Interrupt	Slave Interrupt	000b	IRQ0	IRQ8	001b	IRQ1	IRQ9	010b	IRQ2	IRQ10	011b	IRQ3	IRQ11	100b	IRQ4	IRQ12	101b	IRQ5	IRQ13	110b	IRQ6	IRQ14	111b	IRQ7	IRQ15
Code	Master Interrupt	Slave Interrupt																										
000b	IRQ0	IRQ8																										
001b	IRQ1	IRQ9																										
010b	IRQ2	IRQ10																										
011b	IRQ3	IRQ11																										
100b	IRQ4	IRQ12																										
101b	IRQ5	IRQ13																										
110b	IRQ6	IRQ14																										
111b	IRQ7	IRQ15																										

13.4.4 ICW3—Master Controller Initialization Command Word 3 Register

Offset Address: 21h Attribute: WO
 Default Value: All bits undefined Size: 8 bits

Bit	Description
7:3	0 = These bits must be programmed to 0.
2	<p>Cascaded Interrupt Controller IRQ Connection — WO. This bit indicates that the slave controller is cascaded on IRQ2. When IRQ8#-IRQ15 is asserted, it goes through the slave controller's priority resolver. The slave controller's INTR output onto IRQ2. IRQ2 then goes through the master controller's priority solver. If it wins, the INTR signal is asserted to the processor, and the returning interrupt acknowledge returns the interrupt vector for the slave controller.</p> <p>1 = This bit must always be programmed to a 1.</p>
1:0	0 = These bits must be programmed to 0.



13.4.7 OCW1—Operational Control Word 1 (Interrupt Mask) Register

Offset Address: Master Controller - 021h Attribute: R/W
 Slave Controller - 0A1h Size: 8 bits
 Default Value: 00h

Bit	Description
7:0	Interrupt Request Mask — R/W. When a 1 is written to any bit in this register, the corresponding IRQ line is masked. When a 0 is written to any bit in this register, the corresponding IRQ mask bit is cleared, and interrupt requests will again be accepted by the controller. Masking IRQ2 on the master controller will also mask the interrupt requests from the slave controller.

13.4.8 OCW2—Operational Control Word 2 Register

Offset Address: Master Controller - 020h Attribute: WO
 Slave Controller - 0A0h Size: 8 bits
 Default Value: Bit[4:0]=undefined, Bit[7:5]=001

Following a part reset or ICW initialization, the controller enters the fully nested mode of operation. Non-specific EOI without rotation is the default. Both rotation mode and specific EOI mode are disabled following initialization.

Bit	Description																				
7:5	Rotate and EOI Codes (R, SL, EOI) — WO. These three bits control the Rotate and End of Interrupt modes and combinations of the two. 000 = Rotate in Auto EOI Mode (Clear) 001 = Non-specific EOI command 010 = No Operation 011 = *Specific EOI Command 100 = Rotate in Auto EOI Mode (Set) 101 = Rotate on Non-Specific EOI Command 110 = *Set Priority Command 111 = *Rotate on Specific EOI Command *L0 - L2 Are Used																				
4:3	OCW2 Select — WO. When selecting OCW2, bits 4:3 = 00																				
2:0	Interrupt Level Select (L2, L1, L0) — WO. L2, L1, and L0 determine the interrupt level acted upon when the SL bit is active. A simple binary code, outlined below, selects the channel for the command to act upon. When the SL bit is inactive, these bits do not have a defined function; programming L2, L1 and L0 to 0 is sufficient in this case.																				
	<table border="0"> <thead> <tr> <th>Code</th> <th>Interrupt Level</th> <th>Code</th> <th>Interrupt Level</th> </tr> </thead> <tbody> <tr> <td>000b</td> <td>IRQ0/8</td> <td>000b</td> <td>IRQ4/12</td> </tr> <tr> <td>001b</td> <td>IRQ1/9</td> <td>001b</td> <td>IRQ5/13</td> </tr> <tr> <td>010b</td> <td>IRQ2/10</td> <td>010b</td> <td>IRQ6/14</td> </tr> <tr> <td>011b</td> <td>IRQ3/11</td> <td>011b</td> <td>IRQ7/15</td> </tr> </tbody> </table>	Code	Interrupt Level	Code	Interrupt Level	000b	IRQ0/8	000b	IRQ4/12	001b	IRQ1/9	001b	IRQ5/13	010b	IRQ2/10	010b	IRQ6/14	011b	IRQ3/11	011b	IRQ7/15
Code	Interrupt Level	Code	Interrupt Level																		
000b	IRQ0/8	000b	IRQ4/12																		
001b	IRQ1/9	001b	IRQ5/13																		
010b	IRQ2/10	010b	IRQ6/14																		
011b	IRQ3/11	011b	IRQ7/15																		



13.4.9 OCW3—Operational Control Word 3 Register

Offset Address: Master Controller – 020h Attribute: WO
 Slave Controller – 0A0h Size: 8 bits
 Default Value: Bit[6,0]=0, Bit[7,4:2]=undefined,
 Bit[5,1]=1

Bit	Description
7	Reserved. Must be 0.
6	Special Mask Mode (SMM) – WO. 1 = The Special Mask Mode can be used by an interrupt service routine to dynamically alter the system priority structure while the routine is executing, through selective enabling/disabling of the other channel's mask bits. Bit 5, the ESMM bit, must be set for this bit to have any meaning.
5	Enable Special Mask Mode (ESMM) – WO. 0 = Disable. The SMM bit becomes a "don't care". 1 = Enable the SMM bit to set or reset the Special Mask Mode.
4:3	OCW3 Select – WO. When selecting OCW3, bits 4:3 = 01
2	Poll Mode Command – WO. 0 = Disable. Poll Command is not issued. 1 = Enable. The next I/O read to the interrupt controller is treated as an interrupt acknowledge cycle. An encoded byte is driven onto the data bus, representing the highest priority level requesting service.
1:0	Register Read Command – WO. These bits provide control for reading the In-Service Register (ISR) and the Interrupt Request Register (IRR). When bit 1=0, bit 0 will not affect the register read selection. When bit 1=1, bit 0 selects the register status returned following an OCW3 read. If bit 0=0, the IRR will be read. If bit 0=1, the ISR will be read. Following ICW initialization, the default OCW3 port address read will be "read IRR". To retain the current selection (read ISR or read IRR), always write a 0 to bit 1 when programming this register. The selected register can be read repeatedly without reprogramming OCW3. To select a new status register, OCW3 must be reprogrammed prior to attempting the read. 00 = No Action 01 = No Action 10 = Read IRQ Register 11 = Read IS Register

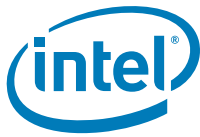

13.4.10 ELCR1—Master Controller Edge/Level Triggered Register

Offset Address: 4D0h
Default Value: 00h

Attribute: R/W
Size: 8 bits

In edge mode, (bit[x] = 0), the interrupt is recognized by a low to high transition. In level mode (bit[x] = 1), the interrupt is recognized by a high level. The cascade channel, IRQ2, the heart beat timer (IRQ0), and the keyboard controller (IRQ1), cannot be put into level mode.

Bit	Description
7	IRQ7 ECL — R/W. 0 = Edge 1 = Level
6	IRQ6 ECL — R/W. 0 = Edge 1 = Level.
5	IRQ5 ECL — R/W. 0 = Edge 1 = Level
4	IRQ4 ECL — R/W. 0 = Edge 1 = Level
3	IRQ3 ECL — R/W. 0 = Edge 1 = Level
2:0	Reserved. Must be 0.



13.4.11 ELCR2—Slave Controller Edge/Level Triggered Register

Offset Address: 4D1h
Default Value: 00h

Attribute: R/W
Size: 8 bits

In edge mode, (bit[x] = 0), the interrupt is recognized by a low to high transition. In level mode (bit[x] = 1), the interrupt is recognized by a high level. The real time clock, IRQ8#, and the floating point error interrupt, IRQ13, cannot be programmed for level mode.

Bit	Description
7	IRQ15 ECL — R/W. 0 = Edge 1 = Level
6	IRQ14 ECL — R/W. 0 = Edge 1 = Level
5	Reserved. Must be 0.
4	IRQ12 ECL — R/W. 0 = Edge 1 = Level
3	IRQ11 ECL — R/W. 0 = Edge 1 = Level
2	IRQ10 ECL — R/W. 0 = Edge 1 = Level
1	IRQ9 ECL — R/W. 0 = Edge 1 = Level
0	Reserved. Must be 0.



13.5 Advanced Programmable Interrupt Controller (APIC)

13.5.1 APIC Register Map

The APIC is accessed using an indirect addressing scheme. Two registers are visible by software for manipulation of most of the APIC registers. These registers are mapped into memory space. The address bits 19:12 of the address range are programmable through bits 7:0 of OIC register (Chipset Config Registers:Offset 31FEh) The registers are shown in [Table 13-4](#).

Table 13-4. APIC Direct Registers

Address	Mnemonic	Register Name	Size	Type
FEC_ _0000h	IND	Index	8 bits	R/W
FEC_ _0010h	DAT	Data	32 bits	R/W
FEC_ _0040h	EOIR	EOI	32 bits	WO

[Table 13-5](#) lists the registers which can be accessed within the APIC using the Index Register. When accessing these registers, accesses must be done one DWord at a time. For example, software should never access byte 2 from the Data register before accessing bytes 0 and 1. The hardware will not attempt to recover from a bad programming model in this case.

Table 13-5. APIC Indirect Registers

Index	Mnemonic	Register Name	Size	Type
00	ID	Identification	32 bits	R/W
01	VER	Version	32 bits	RO
02-0F	—	Reserved	—	RO
10-11	REDIR_TBLO	Redirection Table 0	64 bits	R/W, RO
12-13	REDIR_TBL1	Redirection Table 1	64 bits	R/W, RO
...
3E-3F	REDIR_TBL23	Redirection Table 23	64 bits	R/W, RO
40-FF	—	Reserved	—	RO

13.5.2 IND—Index Register

Memory Address FEC_ _0000h Attribute: R/W
 Default Value: 00h Size: 8 bits

The Index Register will select which APIC indirect register to be manipulated by software. The selector values for the indirect registers are listed in [Table 13-5](#). Software will program this register to select the desired APIC internal register

Bit	Description
7:0	APIC Index — R/W. This is an 8-bit pointer into the I/O APIC register table.



13.5.3 DAT—Data Register

Memory Address FEC_0000h Attribute: R/W
 Default Value: 00000000h Size: 32 bits

This is a 32-bit register specifying the data to be read or written to the register pointed to by the Index register. This register can only be accessed in DWord quantities.

Bit	Description
7:0	APIC Data — R/W. This is a 32-bit register for the data to be read or written to the APIC indirect register (Figure 13-5) pointed to by the Index register (Memory Address FEC0_0000h).

13.5.4 EOIR—EOI Register

Memory Address FEC_0000h Attribute: R/W
 Default Value: N/A Size: 32 bits

The EOI register is present to provide a mechanism to maintain the level triggered semantics for level-triggered interrupts issued on the parallel bus.

When a write is issued to this register, the I/O APIC will check the lower 8 bits written to this register, and compare it with the vector field for each entry in the I/O Redirection Table. When a match is found, the Remote_IRR bit (Index Offset 10h, bit 14) for that I/O Redirection Entry will be cleared.

Note: If multiple I/O Redirection entries, for any reason, assign the same vector for more than one interrupt input, each of those entries will have the Remote_IRR bit reset to 0. The interrupt, which was prematurely reset, will not be lost because if its input remained active when the Remote_IRR bit was cleared, the interrupt will be reissued and serviced at a later time. Note that only bits 7:0 are actually used. Bits 31:8 are ignored by the PCH.

Note: To provide for future expansion, the processor should always write a value of 0 to Bits 31:8.

Bit	Description
31:8	Reserved. To provide for future expansion, the processor should always write a value of 0 to Bits 31:8.
7:0	Redirection Entry Clear — WO. When a write is issued to this register, the I/O APIC will check this field, and compare it with the vector field for each entry in the I/O Redirection Table. When a match is found, the Remote_IRR bit for that I/O Redirection Entry will be cleared.



13.5.5 ID—Identification Register

Index Offset: 00h Attribute: R/W
 Default Value: 00000000h Size: 32 bits

The APIC ID serves as a physical name of the APIC. The APIC bus arbitration ID for the APIC is derived from its I/O APIC ID. This register is reset to 0 on power-up reset.

Bit	Description
31:28	Reserved
27:24	APIC ID — R/W. Software must program this value before using the APIC.
23:16	Reserved
15	Scratchpad Bit.
14:0	Reserved

13.5.6 VER—Version Register

Index Offset: 01h Attribute: RO, R/WO
 Default Value: 00170020h Size: 32 bits

Each I/O APIC contains a hardwired Version Register that identifies different implementations of APIC and their versions. The maximum redirection entry information also is in this register, to let software know how many interrupt are supported by this APIC.

Bit	Description
31:24	Reserved
23:16	Maximum Redirection Entries (MRE) — R/WO. This is the entry number (0 being the lowest entry) of the highest entry in the redirection table. It is equal to the number of interrupt input pins minus one and is in the range 0 through 239. In the PCH this field is hardwired to 17h to indicate 24 interrupts. BIOS must write to this field after PLTRST# to lockdown the value. this allows BIOS to utilize some of the entries for its own purpose and thus advertising fewer IOxAPIC Redirection Entries to the OS.
15	Pin Assertion Register Supported (PRQ) — RO. Indicate that the IOxAPIC does not implement the Pin Assertion Register.
14:8	Reserved
7:0	Version (VS) — RO. This is a version number that identifies the implementation version.



13.5.7 REDIR_TBL—Redirection Table Register

Index Offset: 10h–11h (vector 0) through 3E–3Fh (vector 23) Attribute: R/W, RO
 Default Value: Bit 16 = 1. All other bits undefined Size: 64 bits each, (accessed as two 32 bit quantities)

The Redirection Table has a dedicated entry for each interrupt input pin. The information in the Redirection Table is used to translate the interrupt manifestation on the corresponding interrupt pin into an APIC message.

The APIC will respond to an edge triggered interrupt as long as the interrupt is held until after the acknowledge cycle has begun. Once the interrupt is detected, a delivery status bit internally to the I/O APIC is set. The state machine will step ahead and wait for an acknowledgment from the APIC unit that the interrupt message was sent. Only then will the I/O APIC be able to recognize a new edge on that interrupt pin. That new edge will only result in a new invocation of the handler if its acceptance by the destination APIC causes the Interrupt Request Register bit to go from 0 to 1. (In other words, if the interrupt was not already pending at the destination.)

Bit	Description
63:56	Destination — R/W. If bit 11 of this entry is 0 (Physical), then bits 59:56 specifies an APIC ID. In this case, bits 63:59 should be programmed by software to 0. If bit 11 of this entry is 1 (Logical), then bits 63:56 specify the logical destination address of a set of processors.
55:48	Extended Destination ID (EDID) — RO. These bits are sent to a local APIC only when in Processor System Bus mode. They become bits 11:4 of the address.
47:17	Reserved
16	Mask — R/W. 0 = Not masked: An edge or level on this interrupt pin results in the delivery of the interrupt to the destination. 1 = Masked: Interrupts are not delivered nor held pending. Setting this bit after the interrupt is accepted by a local APIC has no effect on that interrupt. This behavior is identical to the device withdrawing the interrupt before it is posted to the processor. It is software's responsibility to deal with the case where the mask bit is set after the interrupt message has been accepted by a local APIC unit but before the interrupt is dispensed to the processor.
15	Trigger Mode — R/W. This field indicates the type of signal on the interrupt pin that triggers an interrupt. 0 = Edge triggered. 1 = Level triggered.
14	Remote IRR — R/W. This bit is used for level triggered interrupts; its meaning is undefined for edge triggered interrupts. 0 = Reset when an EOI message is received from a local APIC. 1 = Set when Local APIC/s accept the level interrupt sent by the I/O APIC.
13	Interrupt Input Pin Polarity — R/W. This bit specifies the polarity of each interrupt signal connected to the interrupt pins. 0 = Active high. 1 = Active low.
12	Delivery Status — RO. This field contains the current status of the delivery of this interrupt. Writes to this bit have no effect. 0 = Idle. No activity for this interrupt. 1 = Pending. Interrupt has been injected, but delivery is not complete.



Bit	Description
11	Destination Mode — R/W. This field determines the interpretation of the Destination field. 0 = Physical. Destination APIC ID is identified by bits 59:56. 1 = Logical. Destinations are identified by matching bit 63:56 with the Logical Destination in the Destination Format Register and Logical Destination Register in each Local APIC.
10:8	Delivery Mode — R/W. This field specifies how the APICs listed in the destination field should act upon reception of this signal. Certain Delivery Modes will only operate as intended when used in conjunction with a specific trigger mode. These encodings are listed in the note below:
7:0	Vector — R/W. This field contains the interrupt vector for this interrupt. Values range between 10h and FEh.

NOTE: Delivery Mode encoding:

- 000 = Fixed. Deliver the signal on the INTR signal of all processor cores listed in the destination. Trigger Mode can be edge or level.
- 001 = Lowest Priority. Deliver the signal on the INTR signal of the processor core that is executing at the lowest priority among all the processors listed in the specified destination. Trigger Mode can be edge or level.
- 010 = SMI (System Management Interrupt). Requires the interrupt to be programmed as edge triggered. The vector information is ignored but must be programmed to all 0s for future compatibility: **not supported**
- 011 = Reserved
- 100 = NMI. Deliver the signal on the NMI signal of all processor cores listed in the destination. Vector information is ignored. NMI is treated as an edge triggered interrupt even if it is programmed as level triggered. For proper operation this redirection table entry must be programmed to edge triggered. The NMI delivery mode does not set the RIRR bit. If the redirection table is incorrectly set to level, the loop count will continue counting through the redirection table addresses. Once the count for the NMI pin is reached again, the interrupt will be sent again: **not supported**
- 101 = INIT. Deliver the signal to all processor cores listed in the destination by asserting the INIT signal. All addressed local APICs will assume their INIT state. INIT is always treated as an edge triggered interrupt even if programmed as level triggered. For proper operation this redirection table entry must be programmed to edge triggered. The INIT delivery mode does not set the RIRR bit. If the redirection table is incorrectly set to level, the loop count will continue counting through the redirection table addresses. Once the count for the INIT pin is reached again, the interrupt will be sent again: **not supported**
- 110 = Reserved
- 111 = ExtINT. Deliver the signal to the INTR signal of all processor cores listed in the destination as an interrupt that originated in an externally connected 8259A compatible interrupt controller. The INTA cycle that corresponds to this ExtINT delivery will be routed to the external controller that is expected to supply the vector. Requires the interrupt to be programmed as edge triggered.



13.6 Real Time Clock Registers

13.6.1 I/O Register Address Map

The RTC internal registers and RAM are organized as two banks of 128 bytes each, called the standard and extended banks. The first 14 bytes of the standard bank contain the RTC time and date information along with four registers, A–D, that are used for configuration of the RTC. The extended bank contains a full 128 bytes of battery backed SRAM, and will be accessible even when the RTC module is disabled (using the RTC configuration register). Registers A–D do not physically exist in the RAM.

All data movement between the host processor and the real-time clock is done through registers mapped to the standard I/O space. The register map is shown in [Table 13-6](#).

Table 13-6. RTC I/O Registers

I/O Locations	If U128E bit = 0	Function
70h and 74h	Also alias to 72h and 76h	Real-Time Clock (Standard RAM) Index Register
71h and 75h	Also alias to 73h and 77h	Real-Time Clock (Standard RAM) Target Register
72h and 76h		Extended RAM Index Register (if enabled)
73h and 77h		Extended RAM Target Register (if enabled)

NOTES:

1. I/O locations 70h and 71h are the standard legacy location for the real-time clock. The map for this bank is shown in [Table 13-7](#). Locations 72h and 73h are for accessing the extended RAM. The extended RAM bank is also accessed using an indexed scheme. I/O address 72h is used as the address pointer and I/O address 73h is used as the data register. Index addresses above 127h are not valid. If the extended RAM is not needed, it may be disabled.
2. Software must preserve the value of bit 7 at I/O addresses 70h and 74h. When writing to this address, software must first read the value, and then write the same value for bit 7 during the sequential address write. Note that port 70h is not directly readable. The only way to read this register is through Alt Access mode. Although RTC Index bits 6:0 are readable from port 74h, bit 7 will always return 0. If the NMI# enable is not changed during normal operation, software can alternatively read this bit once and then retain the value for all subsequent writes to port 70h.

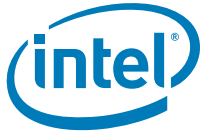

13.6.2 Indexed Registers

The RTC contains two sets of indexed registers that are accessed using the two separate Index and Target registers (70/71h or 72/73h), as shown in [Table 13-7](#).

Table 13-7. RTC (Standard) RAM Bank

Index	Name
00h	Seconds
01h	Seconds Alarm
02h	Minutes
03h	Minutes Alarm
04h	Hours
05h	Hours Alarm
06h	Day of Week
07h	Day of Month
08h	Month
09h	Year
0Ah	Register A
0Bh	Register B
0Ch	Register C
0Dh	Register D
0Eh-7Fh	114 Bytes of User RAM



13.6.2.1 RTC_REGA—Register A

RTC Index:	0A	Attribute:	R/W
Default Value:	Undefined	Size:	8-bit
Lockable:	No	Power Well:	RTC

This register is used for general configuration of the RTC functions. None of the bits are affected by RSMRST# or any other PCH reset signal.

Bit	Description
7	<p>Update In Progress (UIP) — R/W. This bit may be monitored as a status flag.</p> <p>0 = The update cycle will not start for at least 488 μs. The time, calendar, and alarm information in RAM is always available when the UIP bit is 0.</p> <p>1 = The update is soon to occur or is in progress.</p>
6:4	<p>Division Chain Select (DV[2:0]) — R/W. These three bits control the divider chain for the oscillator, and are not affected by RSMRST# or any other reset signal.</p> <p>010 = Normal Operation</p> <p>11X = Divider Reset</p> <p>101 = Bypass 15 stages (test mode only)</p> <p>100 = Bypass 10 stages (test mode only)</p> <p>011 = Bypass 5 stages (test mode only)</p> <p>001 = Invalid</p> <p>000 = Invalid</p>
3:0	<p>Rate Select (RS[3:0]) — R/W. Selects one of 13 taps of the 15 stage divider chain. The selected tap can generate a periodic interrupt if the PIE bit is set in Register B. Otherwise this tap will set the PF flag of Register C. If the periodic interrupt is not to be used, these bits should all be set to 0. RS3 corresponds to bit 3.</p> <p>0000 = Interrupt never toggles</p> <p>0001 = 3.90625 ms</p> <p>0010 = 7.8125 ms</p> <p>0011 = 122.070 μs</p> <p>0100 = 244.141 μs</p> <p>0101 = 488.281 μs</p> <p>0110 = 976.5625 μs</p> <p>0111 = 1.953125 ms</p> <p>1000 = 3.90625 ms</p> <p>1001 = 7.8125 ms</p> <p>1010 = 15.625 ms</p> <p>1011 = 31.25 ms</p> <p>1100 = 62.5 ms</p> <p>1101 = 125 ms</p> <p>1110 = 250 ms</p> <p>1111 = 500 ms</p>



13.6.2.2 RTC_REGB—Register B (General Configuration)

RTC Index: 0Bh Attribute: R/W
 Default Value: U0U00UUU (U: Undefined) Size: 8-bit
 Lockable: No Power Well: RTC

Bit	Description
7	<p>Update Cycle Inhibit (SET) — R/W. Enables/Inhibits the update cycles. This bit is not affected by RSMRST# nor any other reset signal.</p> <p>0 = Update cycle occurs normally once each second. 1 = A current update cycle will abort and subsequent update cycles will not occur until SET is returned to 0. When set is one, the BIOS may initialize time and calendar bytes safely.</p> <p>NOTE: This bit should be set then cleared early in BIOS POST after each powerup directly after coin-cell battery insertion.</p>
6	<p>Periodic Interrupt Enable (PIE) — R/W. This bit is cleared by RSMRST#, but not on any other reset.</p> <p>0 = Disable. 1 = Enable. Allows an interrupt to occur with a time base set with the RS bits of register A.</p>
5	<p>Alarm Interrupt Enable (AIE) — R/W. This bit is cleared by RTCRST#, but not on any other reset.</p> <p>0 = Disable. 1 = Enable. Allows an interrupt to occur when the AF is set by an alarm match from the update cycle. An alarm can occur once a second, one an hour, once a day, or one a month.</p>
4	<p>Update-Ended Interrupt Enable (UIE) — R/W. This bit is cleared by RSMRST#, but not on any other reset.</p> <p>0 = Disable. 1 = Enable. Allows an interrupt to occur when the update cycle ends.</p>
3	<p>Square Wave Enable (SQWE) — R/W. This bit serves no function in the PCH. It is left in this register bank to provide compatibility with the Motorola 146818B. The PCH has no SQW pin. This bit is cleared by RSMRST#, but not on any other reset.</p>
2	<p>Data Mode (DM) — R/W. This bit specifies either binary or BCD data representation. This bit is not affected by RSMRST# nor any other reset signal.</p> <p>0 = BCD 1 = Binary</p>
1	<p>Hour Format (HOURFORM) — R/W. This bit indicates the hour byte format. This bit is not affected by RSMRST# nor any other reset signal.</p> <p>0 = Twelve-hour mode. In twelve-hour mode, the seventh bit represents AM as 0 and PM as one. 1 = Twenty-four hour mode.</p>
0	<p>Daylight Savings Legacy Software Support (DLSWS) — R/W. Daylight savings functionality is no longer supported. This bit is used to maintain legacy software support and has no associated functionality. If BUC.DSO bit is set, the DLSWS bit continues to be R/W.</p>



13.6.2.3 RTC_REGC—Register C (Flag Register)

RTC Index: 0Ch Attribute: RO
 Default Value: 00U00000 (U: Undefined) Size: 8-bit
 Lockable: No Power Well: RTC

Writes to Register C have no effect.

Bit	Description
7	Interrupt Request Flag (IRQF) — RO. $IRQF = (PF * PIE) + (AF * AIE) + (UF * UFE)$. This bit also causes the RTC Interrupt to be asserted. This bit is cleared upon RSMRST# or a read of Register C.
6	Periodic Interrupt Flag (PF) — RO. This bit is cleared upon RSMRST# or a read of Register C. 0 = If no taps are specified using the RS bits in Register A, this flag will not be set. 1 = Periodic interrupt Flag will be 1 when the tap specified by the RS bits of register A is 1.
5	Alarm Flag (AF) — RO. 0 = This bit is cleared upon RTCRST# or a read of Register C. 1 = Alarm Flag will be set after all Alarm values match the current time.
4	Update-Ended Flag (UF) — RO. 0 = The bit is cleared upon RSMRST# or a read of Register C. 1 = Set immediately following an update cycle for each second.
3:0	Reserved. Will always report 0.

13.6.2.4 RTC_REGD—Register D (Flag Register)

RTC Index: 0Dh Attribute: R/W
 Default Value: 10UUUUUU (U: Undefined) Size: 8-bit
 Lockable: No Power Well: RTC

Bit	Description
7	Valid RAM and Time Bit (VRT) — R/W. 0 = This bit should always be written as a 0 for write cycle, however it will return a 1 for read cycles. 1 = This bit is hardwired to 1 in the RTC power well.
6	Reserved. This bit always returns a 0 and should be set to 0 for write cycles.
5:0	Date Alarm — R/W. These bits store the date of month alarm value. If set to 000000b, then a don't care state is assumed. The host must configure the date alarm for these bits to do anything, yet they can be written at any time. If the date alarm is not enabled, these bits will return 0s to mimic the functionality of the Motorola 146818B. These bits are not affected by any reset assertion.



13.7 Processor Interface Registers

Table 13-8 is the register address map for the processor interface registers.

Table 13-8. Processor Interface PCI Register Address Map

Offset	Mnemonic	Register Name	Default A	Attribute
61h	NMI_SC	NMI Status and Control	00h	R/W, RO
70h	NMI_EN	NMI Enable	80h	R/W (special)
92h	PORT92	Fast A20 and Init	00h	R/W
F0h	COPROC_ERR	Coprocessor Error	00h	WO
CF9h	RST_CNT	Reset Control	00h	R/W

13.7.1 NMI_SC—NMI Status and Control Register

I/O Address:	61h	Attribute:	R/W, RO
Default Value:	00h	Size:	8-bit
Lockable:	No	Power Well:	Core

Bit	Description
7	<p>SERR# NMI Source Status (SERR#_NMI_STS) — RO. 1 = Bit is set if a PCI agent detected a system error and pulses the PCI SERR# line and if bit 2 (PCI_SERR_EN) is cleared. This interrupt source is enabled by setting bit 2 to 0. To reset the interrupt, set bit 2 to 1 and then set it to 0. When writing to port 61h, this bit must be 0.</p> <p>NOTE: This bit is set by any of the PCH internal sources of SERR; this includes SERR assertions forwarded from the secondary PCI bus, errors on a PCI Express* port, or other internal functions that generate SERR#.</p>
6	<p>IOCHK# NMI Source Status (IOCHK#_NMI_STS) — RO. 1 = Bit is set if an LPC agent (using SERIRQ) asserted IOCHK# and if bit 3 (IOCHK_NMI_EN) is cleared. This interrupt source is enabled by setting bit 3 to 0. To reset the interrupt, set bit 3 to 1 and then set it to 0. When writing to port 61h, this bit must be a 0.</p>
5	<p>Timer Counter 2 OUT Status (TMR2_OUT_STS) — RO. This bit reflects the current state of the 8254 counter 2 output. Counter 2 must be programmed following any PCI reset for this bit to have a determinate value. When writing to port 61h, this bit must be a 0.</p>
4	<p>Refresh Cycle Toggle (REF_TOGGLE) — RO. This signal toggles from either 0 to 1 or 1 to 0 at a rate that is equivalent to when refresh cycles would occur. When writing to port 61h, this bit must be a 0.</p>
3	<p>IOCHK# NMI Enable (IOCHK_NMI_EN) — R/W. 0 = Enabled. 1 = Disabled and cleared.</p>
2	<p>PCI SERR# Enable (PCI_SERR_EN) — R/W. 0 = SERR# NMIs are enabled. 1 = SERR# NMIs are disabled and cleared.</p>
1	<p>Speaker Data Enable (SPKR_DAT_EN) — R/W. 0 = SPKR output is a 0. 1 = SPKR output is equivalent to the Counter 2 OUT signal value.</p>
0	<p>Timer Counter 2 Enable (TIM_CNT2_EN) — R/W. 0 = Disable 1 = Enable</p>



13.7.2 NMI_EN—NMI Enable (and Real Time Clock Index) Register

I/O Address:	70h	Attribute:	R/W (special)
Default Value:	80h	Size:	8-bit
Lockable:	No	Power Well:	Core

Note: The RTC Index field is write-only for normal operation. This field can only be read in Alt-Access Mode. Note, however, that this register is aliased to Port 74h (documented in Table 13-6), and all bits are readable at that address.

Bits	Description
7	NMI Enable (NMI_EN) — R/W (special). 0 = Enable NMI sources. 1 = Disable All NMI sources.
6:0	Real Time Clock Index Address (RTC_INDX) — R/W (special). This data goes to the RTC to select which register or CMOS RAM address is being accessed.

13.7.3 PORT92—Fast A20 and Init Register

I/O Address:	92h	Attribute:	R/W
Default Value:	00h	Size:	8-bit
Lockable:	No	Power Well:	Core

Bit	Description
7:2	Reserved
1	Alternate A20 Gate (ALT_A20_GATE) — R/W. This bit is Or'd with the A20GATE input signal to generate A20M# to the processor. 0 = A20M# signal can potentially go active. 1 = This bit is set when INIT# goes active.
0	INIT_NOW — R/W. When this bit transitions from a 0 to a 1, the PCH will force INIT# active for 16 PCI clocks.

13.7.4 COPROC_ERR—Coprocessor Error Register

I/O Address:	F0h	Attribute:	WO
Default Value:	00h	Size:	8-bits
Lockable:	No	Power Well:	Core

Bits	Description
7:0	Coprocessor Error (COPROC_ERR) — WO. Any value written to this register will cause IGNNE# to go active, if FERR# had generated an internal IRQ13. For FERR# to generate an internal IRQ13, the COPROC_ERR_EN bit must be 1.



13.8 Power Management Registers

The power management registers are distributed within the PCI Device 31: Function 0 space, as well as a separate I/O range. Each register is described below. Unless otherwise indicated, bits are in the main (core) power well.

Bits not explicitly defined in each register are assumed to be reserved. When writing to a reserved bit, the value should always be 0. Software should not attempt to use the value read from a reserved bit, as it may not be consistently 1 or 0.

13.8.1 Power Management PCI Configuration Registers (PM—D31:F0)

Table 13-9 shows a small part of the configuration space for PCI Device 31: Function 0. It includes only those registers dedicated for power management. Some of the registers are only used for Legacy Power management schemes.

Table 13-9. Power Management PCI Register Address Map (PM—D31:F0)

Offset	Mnemonic	Register Name	Default A	tribute
A0h–A1h	GEN_PMCON_1	General Power Management Configuration 1	0000h	R/W, R/WO, RO
A2h	GEN_PMCON_2	General Power Management Configuration 2	00h	R/W, R/WC, RO
A4h–A5h	GEN_PMCON_3	General Power Management Configuration 3	4206h	R/W, R/WC
A6h	GEN_PMCON_LOCK	General Power Management Configuration Lock	00h	RO, R/WLO
A9h	CIR4	Chipset Initialization Register 4	03h	R/W
AAh	BM_BREAK_EN_2	BM_BREAK_EN Register #2	00h	R/W, RO
ABh	BM_BREAK_EN	BM_BREAK_EN Register	00h	R/W
ACh–AFh	PMIR	Power Management Initialization	00000000h	R/W, R/WLO
B8h–BBh	GPI_ROUT	GPI Route Control	00000000h	R/W



13.8.1.1 GEN_PMCON_1—General PM Configuration 1 Register (PM—D31:F0)

Offset Address:	A0h	Attribute:	R/W, RO, R/WO
Default Value:	0000h	Size:	16-bit
Lockable:	No	Usage:	ACPI, Legacy
		Power Well:	Core

Bit	Description
15:12	Reserved
11	GEN_PMCON_1 Field 1 — R/W. BIOS must program this field to 1b.
10	BIOS_PCI_EXP_EN — R/W. This bit acts as a global enable for the SCI associated with the PCI Express* ports. 0 = The various PCI Express ports and processor cannot cause the PCI_EXP_STS bit to go active. 1 = The various PCI Express ports and processor can cause the PCI_EXP_STS bit to go active.
9	PWRBTN_LVL — RO. This bit indicates the current state of the PWRBTN# signal. 0 = Low. 1 = High.
8:5	Reserved
4	SMI_LOCK — R/WO. When this bit is set, writes to the GLB_SMI_EN bit (PMBASE + 30h, bit 0) will have no effect. Once the SMI_LOCK bit is set, writes of 0 to SMI_LOCK bit will have no effect (that is, once set, this bit can only be cleared by PLTRST#).
3 (Mobile Only)	Reserved
3 (Desktop Only)	Pseudo CLKRUN_EN(PSEUDO_CLKRUN_EN) — R/W. 0 = Disable. 1 = Enable internal CLKRUN# logic to allow DMI PLL shutdown. This bit has no impact on state of external CLKRUN# pin. NOTES: 1. PSEUDO_CLKRUN_EN bit does not result in STP_PCI# assertion to actually stop the external PCICLK. 2. This bit should be set mutually exclusive with the CLKRUN_EN bit. Setting PSEUDO_CLKRUN_EN in a mobile SKU could result in unspecified behavior.
2 (Mobile Only)	PCI CLKRUN# Enable (CLKRUN_EN) — R/W. 0 = Disable. PCH drives the CLKRUN# signal low. 1 = Enable CLKRUN# logic to control the system PCI clock using the CLKRUN# and STP_PCI# signals. NOTES: 1. When the SLP_EN# bit is set, the PCH drives the CLKRUN# signal low regardless of the state of the CLKRUN_EN bit. This ensures that the PCI and LPC clocks continue running during a transition to a sleep state. 2. This bit should be set mutually exclusive with the PSEUDO_CLKRUN_EN bit. Setting CLKRUN_EN in a non-mobile SKU could result in unspecified behavior.
2 (Desktop Only)	Reserved

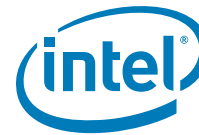

Bit	Description
1:0	<p>Periodic SMI# Rate Select (PER_SMI_SEL) — R/W. Set by software to control the rate at which periodic SMI# is generated.</p> <p>00 = 64 seconds 01 = 32 seconds 10 = 16 seconds 11 = 8 seconds</p>

13.8.1.2 GEN_PMCON_2—General PM Configuration 2 Register (PM—D31:F0)

Offset Address:	A2h	Attribute:	R/W, RO, R/WC
Default Value:	00h	Size:	8-bit
Lockable:	No	Usage:	ACPI, Legacy
		Power Well:	Resume

Bit	Description
7	<p>DRAM Initialization Bit — R/W. This bit does not affect hardware functionality in any way. BIOS is expected to set this bit prior to starting the DRAM initialization sequence and to clear this bit after completing the DRAM initialization sequence. BIOS can detect that a DRAM initialization sequence was interrupted by a reset by reading this bit during the boot sequence.</p> <ul style="list-style-type: none"> If the bit is 1, then the DRAM initialization was interrupted. This bit is reset by the assertion of the RSMRST# pin.
6	Reserved
5	<p>Memory Placed in Self-Refresh (MEM_SR) — RO.</p> <ul style="list-style-type: none"> If the bit is 1, DRAM should have remained powered and held in Self-Refresh through the last power state transition (that is, the last time the system left S0). This bit is reset by the assertion of the RSMRST# pin.
4	<p>System Reset Status (SRS) — R/WC. Software clears this bit by writing a 1 to it. 0 = SYS_RESET# button Not pressed. 1 = PCH sets this bit when the SYS_RESET# button is pressed. BIOS is expected to read this bit and clear it, if it is set.</p> <p>NOTES:</p> <ol style="list-style-type: none"> This bit is also reset by RSMRST# and CF9h resets. The SYS_RESET# is implemented in the Main power well. This pin must be properly isolated and masked to prevent incorrectly setting this Suspend well status bit.
3	<p>Processor Thermal Trip Status (CTS) — R/WC. 0 = Software clears this bit by writing a 1 to it. 1 = This bit is set when PLTRST# is inactive and THRMTRIP# goes active while the system is in an S0 or S1 state.</p> <p>NOTES:</p> <ol style="list-style-type: none"> This bit is also reset by RSMRST#, and CF9h resets. It is not reset by the shutdown and reboot associated with the processor THRMTRIP# event. The CF9h reset in the description refers to CF9h type core well reset which includes SYS_RESET#, PWROK/SYS_PWROK low, SMBus hard reset, TCO Timeout. This type of reset will clear CTS bit.



Bit	Description
2	<p>Minimum SLP_S4# Assertion Width Violation Status — R/WC.</p> <p>0 = Software clears this bit by writing a 1 to it. 1 = Hardware sets this bit when the SLP_S4# assertion width is less than the time programmed in the SLP_S4# Minimum Assertion Width field (D31:F0:Offset A4h:bits 5:4). The PCH begins the timer when SLP_S4# is asserted during S4/S5 entry or when the RSMRST# input is deasserted during SUS well power-up. Note that this bit is functional regardless of the values in the SLP_S4# Assertion Stretch Enable (D31:F0:Offset A4h:bit 3) and in the Disable SLP Stretching after SUS Well Power Up (D31:F0:Offset A4h:bit 12).</p> <p>NOTE: This bit is reset by the assertion of the RSMRST# pin, but can be set in some cases before the default value is readable.</p>
1	<p>SYS_PWROK Failure (SYSPWR_FLR) — R/WC.</p> <p>0 = This bit will be cleared only by software writing a 1 back to the bit or by SUS well power loss. 1 = This bit will be set any time SYS_PWROK drops unexpectedly when the system was in S0 or S1 state.</p>
0	<p>PWROK Failure (PWROK_FLR) — R/WC.</p> <p>0 = This bit will be cleared only by software writing a 1 back to the bit or by SUS well power loss. 1 = This bit will be set any time PWROK goes low when the system was in S0 or S1 state.</p> <p>NOTE: See Chapter 5.13.10.3 for more details about the PWROK pin functionality.</p>

13.8.1.3 GEN_PMCON_3—General PM Configuration 3 Register (PM—D31:F0)

Offset Address:	A4h	Attribute:	R/W, R/WC
Default Value:	4206h	Size:	16-bit
Lockable:	No	Usage:	ACPI, Legacy
		Power Well:	RTC, SUS

Bit	Description															
15	<p>PME B0 S5 Disable (PME_B0_S5_DIS)— R/W. When set to 1, this bit blocks wake events from PME_B0_STS in S5, regardless of the state of PME_B0_EN. When cleared (default), wake events from PME_B0_STS are allowed in S5 if PME_B0_EN = 1.</p> <p>Wakes from power states other than S5 are not affected by this policy bit. The net effect of setting PME_B0_S5_DIS = '1' is described by the truth table below:</p> <p>Y = Wake; N = Don't wake; B0 = PME_B0_EN; OV = WOL Enable Override</p> <table border="1"> <thead> <tr> <th>B0/OV</th> <th>S1/S3/S4</th> <th>S5</th> </tr> </thead> <tbody> <tr> <td>00</td> <td>N</td> <td>N</td> </tr> <tr> <td>01</td> <td>N</td> <td>Y (LAN only)</td> </tr> <tr> <td>11</td> <td>Y (all PME B0 sources)</td> <td>Y (LAN only)</td> </tr> <tr> <td>10</td> <td>Y (all PME B0 sources)</td> <td>N</td> </tr> </tbody> </table> <p>This bit is cleared by the RTCRST# pin.</p>	B0/OV	S1/S3/S4	S5	00	N	N	01	N	Y (LAN only)	11	Y (all PME B0 sources)	Y (LAN only)	10	Y (all PME B0 sources)	N
B0/OV	S1/S3/S4	S5														
00	N	N														
01	N	Y (LAN only)														
11	Y (all PME B0 sources)	Y (LAN only)														
10	Y (all PME B0 sources)	N														



Bit	Description
14	<p>SUS Well Power Failure (SUS_PWR_FLR) — R/WC.</p> <p>0 = Software writes a 1 to this bit to clear it. 1 = This bit is set to '1' whenever SUS well power is lost, as indicated by RSMRST# assertion.</p> <p>This bit is in the SUS well, and defaults to '1' based on RSMRST# assertion (not cleared by any type of reset).</p>
13	<p>WOL Enable Override (WOL_EN_OVRD) — R/W.</p> <p>0 = WOL policies are determined by PME_B0 enable bit and appropriate LAN status bits 1 = Enable appropriately configured integrated LAN to wake the system in S5 only regardless of the value in the PME_B0_EN bit in the GPE0_EN register.</p> <p>This bit is cleared by the RTCRST# pin.</p>
12	<p>Disable SLP Stretching After SUS Well Power Up (DIS_SLP_STRCH_SUS_UP) — R/W</p> <p>0 = Enables stretching on SLP signals after SUS power failure as enabled and configured in other fields. 1 = Disables stretching on SLP signals when powering up after a SUS well power loss. regardless of the state of the SLP_S4# Assertion Stretch Enable (bit 3).</p> <p>This bit is cleared by the RTCRST# pin.</p> <p>NOTES:</p> <ol style="list-style-type: none"> 1. This field is RO when the SLP Stretching Policy Lock-Down bit is set. 2. If this bit is cleared, SLP stretch timers start on SUS well power up (the PCH has no ability to count stretch time while the SUS well is powered down). 3. This policy bit has a different effect on SLP_SUS# stretching than on the other SLP_* pins since SLP_SUS# is the control signal for one of the scenarios where SUS well power is lost (Deep S4/S5). The effect of setting this bit to '1' on: <ul style="list-style-type: none"> – SLP_S3# and SLP_S4# stretching: disabled after any SUS power loss. – SLP_SUS# stretching: disabled after G3, but no impact on Deep S4/S5.
11:10	<p>SLP_S3# Minimum Assertion Width — R/W. This 2-bit value indicates the minimum assertion width of the SLP_S3# signal to ensure that the Main power supplies have been fully power-cycled.</p> <p>Valid Settings are:</p> <p>00 = 60 us 01 = 1 ms 10 = 50 ms 11 = 2 s</p> <p>This bit is cleared by the RSMRST# pin.</p> <p>NOTE: This field is RO when the SLP Stretching Policy Lock-Down bit is set.</p>
9	<p>General Reset Status (GEN_RST_STS) — R/WC. This bit is set by hardware whenever PLTRST# asserts for any reason other than going into a software-entered sleep state (using PM1CNT.SLP_EN write) or a suspend well power failure (RSMRST# pin assertion). BIOS is expected to consult and then write a 1 to clear this bit during the boot flow before determining what action to take based on PM1_STS.WAK_STS = 1. If GEN_RST_STS = 1, the cold reset boot path should be followed rather than the resume path, regardless of the setting of WAK_STS.</p> <p>This bit is cleared by the RSMRST# pin.</p>



Bit	Description
8	<p>SLP_LAN# Default Value (SLP_LAN_DEFAULT) — R/W. This bit specifies the value to drive on the SLP_LAN# pin when in Sx/Moff and Intel ME FW nor host BIOS has configured SLP_LAN#. When this bit is set to 1 SLP_LAN# will default to be driven high, when set to 0 SLP_LAN# will default to be driven low.</p> <p>This bit will always determine SLP_LAN# behavior when in S4/S5/Moff after SUS power loss, in S5/Moff after a host partition reset with power down and when in S5/Moff due to an unconditional power down.</p> <p>This bit is cleared by RTCRST#.</p>
7:6	<p>SWSMI_RATE_SEL — R/W. This field indicates when the SWSMI timer will time out.</p> <p>Valid values are:</p> <p>00 = 1.5 ms ± 0.6 ms 01 = 16 ms ± 4 ms 10 = 32 ms ± 4 ms 11 = 64 ms ± 4 ms</p> <p>These bits are not cleared by any type of reset except RTCRST#.</p>
5:4	<p>SLP_S4# Minimum Assertion Width — R/W. This field indicates the minimum assertion width of the SLP_S4# signal to ensure that the DRAM modules have been safely power-cycled.</p> <p>Valid values are:</p> <p>11 = 1 second 10 = 2 seconds 01 = 3 seconds 00 = 4 seconds</p> <p>This value is used in two ways:</p> <ol style="list-style-type: none"> If the SLP_S4# assertion width is ever shorter than this time, a status bit is set for BIOS to read when S0 is entered. If enabled by bit 3 in this register, the hardware will prevent the SLP_S4# signal from deasserting within this minimum time period after asserting. <p>RTCRST# forces this field to the conservative default state (00b).</p> <p>NOTES:</p> <ol style="list-style-type: none"> This field is RO when the SLP Stretching Policy Lock-Down bit is set. Note that the logic that measures this time is in the suspend power well. Therefore, when leaving a G3 or Deep S4/S5 state, the minimum time is measured from the deassertion of the internal suspend well reset (unless the "Disable SLP Stretching After SUS Well Power Up" bit is set).
3	<p>SLP_S4# Assertion Stretch Enable — R/W.</p> <p>0 = The SLP_S4# minimum assertion time is defined in Power Sequencing and Reset Signal Timings table.</p> <p>1 = The SLP_S4# signal minimally assert for the time specified in bits 5:4 of this register.</p> <p>This bit is cleared by RTCRST#.</p> <p>NOTE: This bit is RO when the SLP Stretching Policy Lock-Down bit is set.</p>
2	<p>RTC Power Status (RTC_PWR_STS) — R/W. This bit is set when RTCRST# indicates a weak or missing battery. The bit is not cleared by any type of reset. The bit will remain set until the software clears it by writing a 0 back to this bit position.</p>



Bit	Description
1	<p>Power Failure (PWR_FLR) — R/WC. This bit is in the DeepS4/S5 well and defaults to 1 based on DPWROK deassertion (not cleared by any type of reset). 0 = Indicates that the trickle current has not failed since the last time the bit was cleared. Software clears this bit by writing a 1 to it. 1 = Indicates that the trickle current (from the main battery or trickle supply) was removed or failed.</p> <p>NOTE: Clearing CMOS in a PCH-based platform can be done by using a jumper on RTCRST# or GPI. Implementations should not attempt to clear CMOS by using a jumper to pull VccRTC low.</p>
0	<p>AFTERG3_EN — R/W. This bit determines what state to go to when power is re-applied after a power failure (G3 state). This bit is in the RTC well and is only cleared by RTCRST# assertion.</p> <p>0 = System will return to S0 state (boot) after power is re-applied. 1 = System will return to the S5 state (except if it was in S4, in which case it will return to S4). In the S5 state, the only enabled wake event is the Power Button or any enabled wake event that was preserved through the power failure.</p>

NOTE: RSMRST# is sampled using the RTC clock. Therefore, low times that are less than one RTC clock period may not be detected by the PCH.



13.8.1.7 BM_BREAK_EN Register (PM—D31:F0)

Offset Address:	ABh	Attribute:	R/W
Default Value:	00h	Size:	8-bit
Lockable:	No	Usage:	ACPI, Legacy
Power Well:	Core		

Bit	Description
7	Storage Break Enable (STORAGE_BREAK_EN) — R/W. 0 = Serial ATA traffic will not cause BM_STS to be set. 1 = Serial ATA traffic will cause BM_STS to be set.
6	PCIE_BREAK_EN — R/W. 0 = PCI Express* traffic will not cause BM_STS to be set. 1 = PCI Express traffic will cause BM_STS to be set.
5	PCI_BREAK_EN — R/W. 0 = PCI traffic will not cause BM_STS to be set. 1 = PCI traffic will cause BM_STS to be set.
4:3	Reserved
2	EHCI_BREAK_EN — R/W. 0 = EHCI traffic will not cause BM_STS to be set. 1 = EHCI traffic will cause BM_STS to be set.
1	Reserved
0	HDA_BREAK_EN — R/W. 0 = Intel® High Definition Audio traffic will not cause BM_STS to be set. 1 = Intel® High Definition Audio traffic will cause BM_STS to be set.



13.8.2 APM I/O Decode Register

Table 13-10 shows the I/O registers associated with APM support. This register space is enabled in the PCI Device 31: Function 0 space (APMDEC_EN), and cannot be moved (fixed I/O location).

Table 13-10. APM Register Map

Address	Mnemonic	Register Name	Default	Type
B2h	APM_CNT	Advanced Power Management Control Port	00h	R/W
B3h	APM_STS	Advanced Power Management Status Port	00h	R/W

13.8.2.1 APM_CNT—Advanced Power Management Control Port Register

I/O Address:	B2h	Attribute:	R/W
Default Value:	00h	Size:	8-bit
Lockable:	No	Usage:	Legacy Only
Power Well:	Core		

Bit	Description
7:0	Used to pass an APM command between the OS and the SMI handler. Writes to this port not only store data in the APMC register, but also generates an SMI# when the APMC_EN bit is set.

13.8.2.2 APM_STS—Advanced Power Management Status Port Register

I/O Address:	B3h	Attribute:	R/W
Default Value:	00h	Size:	8-bit
Lockable:	No	Usage:	Legacy Only
Power Well:	Core		

Bit	Description
7:0	Used to pass data between the OS and the SMI handler. Basically, this is a scratchpad register and is not affected by any other register or function (other than a PCI reset).



13.8.3 Power Management I/O Registers

Table 13-11 shows the registers associated with ACPI and Legacy power management support. These registers locations are all offsets from the ACPI base address defined in the PCI Device 31: Function 0 space (PMBASE), and can be moved to any 128-byte aligned I/O location. In order to access these registers, the ACPI Enable bit (ACPI_EN) must be set. The registers are defined to support the ACPI 4.0a specification and generally use the same bit names.

Note: All reserved bits and registers will always return 0 when read, and will have no effect when written.

Table 13-11. ACPI and Legacy I/O Register Map

PMBASE + Offset	Mnemonic	Register Name	Default	Attribute
00h-01h	PM1_STS	PM1 Status	0000h	R/WC
02h-03h	PM1_EN	PM1 Enable	0000h	R/W
04h-07h	PM1_CNT	PM1 Control	00000000h	R/W, WO
08h-0Bh	PM1_TMR	PM1 Timer	xx000000h	RO
20h-27h	GPE0_STS	General Purpose Event 0 Status	000000000 000000h	R/WC
28h-2Fh	GPE0_EN	General Purpose Event 0 Enables	00000000 00000000h	R/W
30h-33h	SMI_EN	SMI# Control and Enable	00000002h	R/W, WO, R/WO
34h-37h	SMI_STS	SMI Status	00000000h	R/WC, RO
38h-39h	ALT_GP_SMI_EN	Alternate GPI SMI Enable	0000h	R/W
3Ah-3Bh	ALT_GP_SMI_STS	Alternate GPI SMI Status	0000h	R/WC
3Ch-3Dh	UPRWC	USB Per-Port Registers Write Control	0000h	R/WC, R/W, R/WO
42h	GPE_CNTL	General Purpose Event Control	00h	R/W
44h-45h	DEVACT_STS	Device Activity Status	0000h	R/WC
50h	PM2_CNT	PM2 Control	00h	R/W
60h-7Fh	—	Reserved for TCO	—	—



13.8.3.1 PM1_STS—Power Management 1 Status Register

I/O Address: PMBASE + 00h
 Attribute: R/WC
 Default Value: 0000h
 Size: 16-bit
 Lockable: No
 Usage: ACPI or Legacy
 Power Well: Bits 0–7: Core,
 Bits 12–15: Resume
 Bit 11: RTC,
 Bits 8 and 10: DSW

If bit 10 or 8 in this register is set, and the corresponding _EN bit is set in the PM1_EN register, then the PCH will generate a Wake Event. Once back in an S0 state (or if already in an S0 state when the event occurs), the PCH will also generate an SCI if the SCI_EN bit is set, or an SMI# if the SCI_EN bit is not set.

Note: Bit 5 does not cause an SMI# or a wake event. Bit 0 does not cause a wake event but can cause an SMI# or SCI.

Bit	Description
15	<p>Wake Status (WAK_STS) — R/WC. This bit is not affected by hard resets caused by a CF9 write, but is reset by RSMRST#.</p> <p>0 = Software clears this bit by writing a 1 to it. 1 = Set by hardware when the system is in one of the sleep states (using the SLP_EN bit) and an enabled wake event occurs. Upon setting this bit, the PCH will transition the system to the ON state.</p> <p>If the AFTERG3_EN bit is not set and a power failure (such as removed batteries) occurs without the SLP_EN bit set, the system will return to an S0 state when power returns, and the WAK_STS bit will not be set.</p> <p>If the AFTERG3_EN bit is set and a power failure occurs without the SLP_EN bit having been set, the system will go into an S5 state when power returns, and a subsequent wake event will cause the WAK_STS bit to be set. Note that any subsequent wake event would have to be caused by either a Power Button press, or an enabled wake event that was preserved through the power failure (enable bit in the RTC well).</p>
14	<p>PCI Express Wake Status (PCIEXPWAK_STS) — R/WC.</p> <p>0 = Software clears this bit by writing a 1 to it. If the WAKE# pin is still active during the write or the PME message received indication has not been cleared in the root port, then the bit will remain active (that is, all inputs to this bit are level-sensitive).</p> <p>1 = This bit is set by hardware to indicate that the system woke due to a PCI Express wakeup event. This wakeup event can be caused by the PCI Express WAKE# pin being active or receipt of a PCI Express PME message at a root port. This bit is set only when one of these events causes the system to transition from a non-S0 system power state to the S0 system power state. This bit is set independent of the state of the PCIEXP_WAKE_DIS bit.</p> <p>NOTE: This bit does not itself cause a wake event or prevent entry to a sleeping state. Thus, if the bit is 1 and the system is put into a sleeping state, the system will not automatically wake.</p>
13:12	Reserved



Bit	Description
11	<p>Power Button Override Status (PWRBTNOR_STS) — R/WC.</p> <p>0 = Software clears this bit by writing a 1 to it.</p> <p>1 = This bit is set any time a Power Button Override occurs (that is, the power button is pressed for at least 4 consecutive seconds), due to the corresponding bit in the SMBus slave message, Intel ME Initiated Power Button Override, Intel ME Initiated Host Reset with Power down or due to an internal thermal sensor catastrophic condition. The power button override causes an unconditional transition to the S5 state. The BIOS or SCI handler clears this bit by writing a 1 to it. This bit is not affected by hard resets using CF9h writes, and is not reset by RSMRST#. Thus, this bit is preserved through power failures. Note that if this bit is still asserted when the global SCI_EN is set then an SCI will be generated.</p>
10	<p>RTC Status (RTC_STS) — R/WC. This bit is not affected by hard resets caused by a CF9 write, but is reset by DPWROK.</p> <p>0 = Software clears this bit by writing a 1 to it.</p> <p>1 = Set by hardware when the RTC generates an alarm (assertion of the IRQ8# signal). Additionally if the RTC_EN bit (PMBASE + 02h, bit 10) is set, the setting of the RTC_STS bit will generate a wake event.</p>
9	Reserved
8	<p>Power Button Status (PWRBTN_STS) — R/WC. This bit is not affected by hard resets caused by a CF9 write but is reset by DPWROK.</p> <p>0 = If the PWRBTN# signal is held low for more than 4 seconds, the hardware clears the PWRBTN_STS bit, sets the PWRBTNOR_STS bit, and the system transitions to the S5 state with only PWRBTN# enabled as a wake event. This bit can be cleared by software by writing a one to the bit position.</p> <p>1 = This bit is set by hardware when the PWRBTN# signal is asserted Low, independent of any other enable bit.</p> <p>In the S0 state, while PWRBTN_EN and PWRBTN_STS are both set, an SCI (or SMI# if SCI_EN is not set) will be generated.</p> <p>In any sleeping state S1-S5, while PWRBTN_EN (PMBASE + 02h, bit 8) and PWRBTN_STS are both set, a wake event is generated.</p> <p>NOTE: If the PWRBTN_STS bit is cleared by software while the PWRBTN# signal is still asserted, this will not cause the PWRBTN_STS bit to be set. The PWRBTN# signal must go inactive and active again to set the PWRBTN_STS bit.</p>
7:6	Reserved
5	<p>Global Status (GBL_STS) — R/WC.</p> <p>0 = The SCI handler should then clear this bit by writing a 1 to the bit location.</p> <p>1 = Set when an SCI is generated due to BIOS wanting the attention of the SCI handler. BIOS has a corresponding bit, BIOS_RLS, which will cause an SCI and set this bit.</p>
4	<p>Bus Master Status (BM_STS) — R/WC. This bit will not cause a wake event, SCI or SMI#.</p> <p>0 = Software clears this bit by writing a 1 to it.</p> <p>1 = Set by the PCH when a PCH-visible bus master requests access to memory or the BM_BUSY# signal is active.</p>
3:1	Reserved
0	<p>Timer Overflow Status (TMROF_STS) — R/WC.</p> <p>0 = The SCI or SMI# handler clears this bit by writing a 1 to the bit location.</p> <p>1 = This bit gets set any time bit 22 of the 24-bit timer goes high (bits are numbered from 0 to 23). This will occur every 2.3435 seconds. When the TMROF_EN bit (PMBASE + 02h, bit 0) is set, then the setting of the TMROF_STS bit will additionally generate an SCI or SMI# (depending on the SCI_EN).</p>



13.8.3.2 PM1_EN—Power Management 1 Enable Register

I/O Address:	PMBASE + 02h	Attribute:	R/W
Default Value:	0000h	Size:	16-bit
Lockable:	No	Usage:	ACPI or Legacy
Power Well:	Bits 0–7: Core, Bits 8–9, 11–15: Resume, Bit 10: RTC		

Bit	Description												
15	Reserved												
14	<p>PCI Express* Wake Disable (PCIEXPWAK_DIS) — R/W. Modification of this bit has no impact on the value of the PCIEXP_WAKE_STS bit.</p> <p>0 = Inputs to the PCIEXP_WAKE_STS bit in the PM1 Status register enabled to wake the system.</p> <p>1 = Inputs to the PCIEXP_WAKE_STS bit in the PM1 Status register disabled from waking the system.</p>												
13:11	Reserved												
10	<p>RTC Event Enable (RTC_EN) — R/W. This bit is in the RTC well to allow an RTC event to wake after a power failure. In addition to being cleared by RTCRST# assertion, the PCH also clears this bit due to a Power Button Override event, Intel ME Initiated Power Button Override, Intel ME Initiated Host Reset with Power down, SMBus unconditional power down, processor thermal trip event, or due to an internal thermal sensor catastrophic condition.</p> <p>0 = No SCI (or SMI#) or wake event is generated then RTC_STS (PMBASE + 00h, bit 10) goes active.</p> <p>1 = An SCI (or SMI#) or wake event will occur when this bit is set and the RTC_STS bit goes active.</p>												
9	Reserved												
8	<p>Power Button Enable (PWRBTN_EN) — R/W. This bit is used to enable the setting of the PWRBTN_STS bit to generate a power management event (SMI#, SCI). PWRBTN_EN has no effect on the PWRBTN_STS bit (PMBASE + 00h, bit 8) being set by the assertion of the power button. The Power Button is always enabled as a Wake event.</p> <p>0 = Disable.</p> <p>1 = Enable.</p>												
7:6	Reserved												
5	<p>Global Enable (GBL_EN) — R/W. When both the GBL_EN and the GBL_STS bit (PMBASE + 00h, bit 5) are set, an SCI is raised.</p> <p>0 = Disable.</p> <p>1 = Enable SCI on GBL_STS going active.</p>												
4:1	Reserved												
0	<p>Timer Overflow Interrupt Enable (TMROF_EN) — R/W. Works in conjunction with the SCI_EN bit (PMBASE + 04h, bit 0) as described below:</p> <table border="1"> <thead> <tr> <th>TMROF_EN</th> <th>SCI_EN</th> <th>Effect when TMROF_STS is set</th> </tr> </thead> <tbody> <tr> <td>0</td> <td>X</td> <td>No SMI# or SCI</td> </tr> <tr> <td>1</td> <td>0</td> <td>SMI#</td> </tr> <tr> <td>1</td> <td>1</td> <td>SCI</td> </tr> </tbody> </table>	TMROF_EN	SCI_EN	Effect when TMROF_STS is set	0	X	No SMI# or SCI	1	0	SMI#	1	1	SCI
TMROF_EN	SCI_EN	Effect when TMROF_STS is set											
0	X	No SMI# or SCI											
1	0	SMI#											
1	1	SCI											



13.8.3.3 PM1_CNT—Power Management 1 Control Register

I/O Address: PMBASE + 04h
 Attribute: R/W, WO
 Default Value: 00000000h
 Size: 32-bit
 Lockable: No
 Usage: ACPI or Legacy
 Power Well: Bits 0–7: Core,
 Bits 8–12: RTC,
 Bits 13–15: Resume

Bit	Description																		
31:14	Reserved																		
13	Sleep Enable (SLP_EN) — WO. Setting this bit causes the system to sequence into the Sleep state defined by the SLP_TYP field.																		
12:10	<p>Sleep Type (SLP_TYP) — R/W. This 3-bit field defines the type of Sleep the system should enter when the SLP_EN bit is set to 1. These bits are only reset by RTCRST#.</p> <table border="1"> <thead> <tr> <th>Code</th> <th>Master Interrupt</th> </tr> </thead> <tbody> <tr> <td>000b</td> <td>ON: Typically maps to S0 state.</td> </tr> <tr> <td>001b</td> <td>Puts Processor Core in S1 state.</td> </tr> <tr> <td>010b</td> <td>Reserved</td> </tr> <tr> <td>011b</td> <td>Reserved</td> </tr> <tr> <td>100b</td> <td>Reserved</td> </tr> <tr> <td>101b</td> <td>Suspend-To-RAM. Assert SLP_S3#: Typically maps to S3 state.</td> </tr> <tr> <td>110b</td> <td>Suspend-To-Disk. Assert SLP_S3#, and SLP_S4#: Typically maps to S4 state.</td> </tr> <tr> <td>111b</td> <td>Soft Off. Assert SLP_S3#, SLP_S4#, and SLP_S5#: Typically maps to S5 state.</td> </tr> </tbody> </table>	Code	Master Interrupt	000b	ON: Typically maps to S0 state.	001b	Puts Processor Core in S1 state.	010b	Reserved	011b	Reserved	100b	Reserved	101b	Suspend-To-RAM. Assert SLP_S3#: Typically maps to S3 state.	110b	Suspend-To-Disk. Assert SLP_S3#, and SLP_S4#: Typically maps to S4 state.	111b	Soft Off. Assert SLP_S3#, SLP_S4#, and SLP_S5#: Typically maps to S5 state.
Code	Master Interrupt																		
000b	ON: Typically maps to S0 state.																		
001b	Puts Processor Core in S1 state.																		
010b	Reserved																		
011b	Reserved																		
100b	Reserved																		
101b	Suspend-To-RAM. Assert SLP_S3#: Typically maps to S3 state.																		
110b	Suspend-To-Disk. Assert SLP_S3#, and SLP_S4#: Typically maps to S4 state.																		
111b	Soft Off. Assert SLP_S3#, SLP_S4#, and SLP_S5#: Typically maps to S5 state.																		
9:3	Reserved																		
2	<p>Global Release (GBL_RLS) — WO.</p> <p>0 = This bit always reads as 0. 1 = ACPI software writes a 1 to this bit to raise an event to the BIOS. BIOS software has a corresponding enable and status bits to control its ability to receive ACPI events.</p>																		
1	<p>Bus Master Reload (BM_RLD) — R/W. This bit is treated as a scratchpad bit. This bit is reset to 0 by PLTRST#</p> <p>0 = Bus master requests will not cause a break from the C3 state. 1 = Enables Bus Master requests (internal or external) to cause a break from the C3 state.</p> <p>If software fails to set this bit before going to C3 state, the PCH will still return to a snooperable state from C3 or C4 states due to bus master activity.</p>																		
0	<p>SCI Enable (SCI_EN) — R/W. Selects the SCI interrupt or the SMI# interrupt for various events including the bits in the PM1_STS register (bit 10, 8, 0), and bits in GPE0_STS.</p> <p>0 = These events will generate an SMI#. 1 = These events will generate an SCI.</p>																		



13.8.3.4 PM1_TMR—Power Management 1 Timer Register

I/O Address: PMBASE + 08h

Default Value:	xx000000h	Attribute:	RO
Lockable:	No	Size:	32-bit
Power Well:	Core	Usage:	ACPI

Bit	Description
31:24	Reserved
23:0	<p>Timer Value (TMR_VAL) — RO. Returns the running count of the PM timer. This counter runs off a 3.579545 MHz clock (14.31818 MHz divided by 4). It is reset to 0 during a PCI reset, and then continues counting as long as the system is in the S0 state. After an S1 state, the counter will not be reset (it will continue counting from the last value in S0 state).</p> <p>Anytime bit 22 of the timer goes HIGH to LOW (bits referenced from 0 to 23), the TMROF_STS bit (PMBASE + 00h, bit 0) is set. The High-to-Low transition will occur every 2.3435 seconds. If the TMROF_EN bit (PMBASE + 02h, bit 0) is set, an SCI interrupt is also generated.</p>

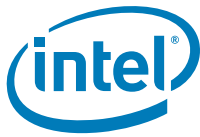

13.8.3.5 GPE0_STS—General Purpose Event 0 Status Register

I/O Address:	PMBASE + 20h	Attribute:	Bits 0:32,35 R/WC Bits 33:34, 36:63 RO
Default Value:	0000000000000000h	Size:	64-bit
Lockable:	No	Usage:	ACPI
Power Well:	Bits 0–34, 56–63: Resume, Bit 35: DSW		

This register is symmetrical to the General Purpose Event 0 Enable Register. Unless indicated otherwise below, if the corresponding `_EN` bit is set, then when the `_STS` bit get set, the PCH will generate a Wake Event. Once back in an S0 state (or if already in an S0 state when the event occurs), the PCH will also generate an SCI if the `SCI_EN` bit is set, or an SMI# if the `SCI_EN` bit (PMBASE + 04h, bit 0) is not set. Bits 31:16 are reset by a CF9h full reset; bits 63:32 and 15:0 are not. All bits (except bit 35) are reset by RSMRST#. Bit 35 is reset by DPWROK.

Bit	Description
63:36	Reserved
35	<p>GPIO27_STS— R/WC.</p> <p>0 = Disable.</p> <p>1 = Set by hardware and can be reset by writing a one to this bit position or a resume well reset. This bit is set at the level specified in GP27IO_POL. Note that GPIO27 is always monitored as an input for the purpose of setting this bit, regardless of the actual GPIO configuration.</p>
34:32	Reserved
31:16	<p>GPIO_n_STS — R/WC.</p> <p>0 = Software clears this bit by writing a 1 to it.</p> <p>1 = These bits are set any time the corresponding GPIO is set up as an input and the corresponding GPIO signal is high (or low if the corresponding GP_INV bit is set). If the corresponding enable bit is set in the GPE0_EN register, then when the GPIO[n]_STS bit is set:</p> <ul style="list-style-type: none"> • If the system is in an S1–S5 state, the event will also wake the system. • If the system is in an S0 state (or upon waking back to an S0 state), a SCI will be caused depending on the GPIO_ROUT bits (D31:F0:B8h, bits 31:30) for the corresponding GPI. <p>NOTE: Mapping is as follows: bit 31 corresponds to GPIO[15]... and bit 16 corresponds to GPIO[0].</p>
15:14	Reserved



Bit	Description
13	<p>PME_B0_STS — R/WC. This bit will be set to 1 by the PCH when any internal device with PCI Power Management capabilities on bus 0 asserts the equivalent of the PME# signal. Additionally, if the PME_B0_EN bit and SCI_EN bits are set, and the system is in an S0 state, then the setting of the PME_B0_STS bit will generate an SCI (or SMI# if SCI_EN is not set). If the PME_B0_STS bit is set, and the system is in an S1–S4 state (or S5 state due to SLP_TYP and SLP_EN), then the setting of the PME_B0_STS bit will generate a wake event. If the system is in an S5 state due to power button override, then the PME_B0_STS bit will not cause a wake event or SCI.</p> <p>The default for this bit is 0. Writing a 1 to this bit position clears this bit. The following are internal devices which can set this bit:</p> <ul style="list-style-type: none"> • Intel HD Audio • Intel Management Engine “maskable” wake events • Integrated LAN • SATA • EHCI
12	Reserved
11	<p>PME_STS — R/WC.</p> <p>0 = Software clears this bit by writing a 1 to it. 1 = Set by hardware when the PME# signal goes active. Additionally, if the PME_EN and SCI_EN bits are set, and the system is in an S0 state, then the setting of the PME_STS bit will generate an SCI or SMI# (if SCI_EN is not set). If the PME_EN bit is set, and the system is in an S1–S4 state (or S5 state due to setting SLP_TYP and SLP_EN), then the setting of the PME_STS bit will generate a wake event. If the system is in an S5 state due to power button override or a power failure, then PME_STS will not cause a wake event or SCI.</p>
10 (Desktop Only)	Reserved
10 (Mobile Only)	<p>BATLOW_STS — R/WC. (Mobile Only) Software clears this bit by writing a 1 to it.</p> <p>0 = BATLOW# Not asserted 1 = Set by hardware when the BATLOW# signal is asserted.</p>
9	<p>PCI_EXP_STS — R/WC.</p> <p>0 = Software clears this bit by writing a 1 to it. 1 = Set by hardware to indicate that:</p> <ul style="list-style-type: none"> • The PME event message was received on one or more of the PCI Express* ports • An Assert PMEGPE message received from the processor using DMI <p>NOTES:</p> <ol style="list-style-type: none"> 1. The PCI WAKE# pin has no impact on this bit. 2. If the PCI_EXP_STS bit went active due to an Assert PMEGPE message, then a Deassert PMEGPE message must be received prior to the software write in order for the bit to be cleared. 3. If the bit is not cleared and the corresponding PCI_EXP_EN bit is set, the level-triggered SCI will remain active. 4. A race condition exists where the PCI Express device sends another PME message because the PCI Express device was not serviced within the time when it must resend the message. This may result in a spurious interrupt, and this is comprehended and approved by the <i>PCI Express* Specification, Revision 1.0a</i>. The window for this race condition is approximately 95–105 milliseconds.



Bit	Description
8	<p>RI_STS — R/WC.</p> <p>0 = Software clears this bit by writing a 1 to it. 1 = Set by hardware when the RI# input signal goes active.</p>
7	<p>SMBus Wake Status (SMB_WAK_STS) — R/WC. The SMBus controller can independently cause an SMI# or SCI, so this bit does not need to do so (unlike the other bits in this register). Software clears this bit by writing a 1 to it.</p> <p>0 = Wake event Not caused by the PCH's SMBus logic. 1 = Set by hardware to indicate that the wake event was caused by the PCH's SMBus logic. This bit will be set by the WAKE/SMI# command type, even if the system is already awake. The SMI handler should then clear this bit.</p> <p>NOTES:</p> <ol style="list-style-type: none"> 1. The SMBus controller will independently cause an SMI# so this bit does not need to do so (unlike the other bits in this register). 2. This bit is set by the SMBus slave command 01h (Wake/SMI#) even when the system is in the S0 state. Therefore, to avoid an instant wake on subsequent transitions to sleep states, software must clear this bit after each reception of the Wake/SMI# command or just prior to entering the sleep state. 3. The SMBALERT_STS bit (D31:F3:I/O Offset 00h:Bit 5) should be cleared by software before the SMB_WAK_STS bit is cleared.
6	<p>TCOSCI_STS — R/WC. Software clears this bit by writing a 1 to it.</p> <p>0 = TOC logic or thermal sensor logic did Not cause SCI. 1 = Set by hardware when the TCO logic or thermal sensor logic causes an SCI.</p>
5:3	Reserved
2	<p>SWGPE_STS — R/WC.</p> <p>The SWGPE_CTRL bit (bit 1 of GPE_CTRL reg) acts as a level input to this bit.</p>
1	<p>HOT_PLUG_STS — R/WC.</p> <p>0 = This bit is cleared by writing a 1 to this bit position. 1 = When a PCI Express* Hot-Plug event occurs. This will cause an SCI if the HOT_PLUG_EN and SCI_EN bits are set.</p>
0	Reserved



13.8.3.6 GPE0_EN—General Purpose Event 0 Enables Register

I/O Address:	PMBASE + 28h	Attribute:	R/W
Default Value:	0000000000000000h	Size:	64-bit
Lockable:	No	Usage:	ACPI
Power Well:	Bits 0–7, 9, 12, 14–34, 36–63 Resume, Bits 8, 10–11, 13,35 RTC		

This register is symmetrical to the General Purpose Event 0 Status Register.

Bit	Description
63:36	Reserved
35	GPIO27_EN — R/W. 0 = Disable. 1 = Enable the setting of the GPIO27_STS bit to generate a wake event/SCI/SMI#. GPIO27 is a valid host wake event from Deep S4/S5. The wake enable configuration persists after a G3 state.
34:32	Reserved
31:16	GPIn_EN — R/W. These bits enable the corresponding GPI[n]_STS bits being set to cause a SCI, and/or wake event. These bits are cleared by RSMRST#. NOTE: Mapping is as follows: bit 31 corresponds to GPIO15... and bit 16 corresponds to GPIO0.
15:14	Reserved
13	PME_BO_EN — R/W. 0 = Disable NOTE: Enables the setting of the PME_BO_STS bit to generate a wake event and/or an SCI or SMI#. In addition to being cleared by RTCRST# assertion, the PCH also clears this bit due to a Power Button Override event, Intel ME Initiated Power Button Override, Intel ME Initiated Host Reset with Power down, SMBus unconditional power down, processor thermal trip event, or due to an internal thermal sensor catastrophic condition.
12	Reserved
11	PME_EN — R/W. 0 = Disable. 1 = Enables the setting of the PME_STS to generate a wake event and/or an SCI. PME# can be a wake event from the S1–S4 state or from S5 (if entered using SLP_EN, but not power button override). In addition to being cleared by RTCRST# assertion, the PCH also clears this bit due to a Power Button Override event, Intel ME Initiated Power Button Override, Intel ME Initiated Host Reset with Power down, SMBus unconditional power down, processor thermal trip event, or due to an internal thermal sensor catastrophic condition.
10 (Desktop Only)	Reserved



Bit	Description
10 (Mobile Only)	<p>BATLOW_EN — R/W. (Mobile Only)</p> <p>0 = Disable.</p> <p>1 = Enables the BATLOW# signal to cause an SMI# or SCI (depending on the SCI_EN bit) when it goes low. This bit does not prevent the BATLOW# signal from inhibiting the wake event.</p> <p>In addition to being cleared by RTCRST# assertion, the PCH also clears this bit due to a Power Button Override event, Intel ME Initiated Power Button Override, Intel ME Initiated Host Reset with Power down, SMBus unconditional power down, processor thermal trip event, or due to an internal thermal sensor catastrophic condition.</p>
9	<p>PCI_EXP_EN — R/W.</p> <p>0 = Disable SCI generation upon PCI_EXP_STS bit being set.</p> <p>1 = Enables PCH to cause an SCI when PCI_EXP_STS bit is set. This is used to allow the PCI Express* ports, including the link to the processor, to cause an SCI due to wake/PME events.</p>
8	<p>RI_EN — R/W. The value of this bit will be maintained through a G3 state and is not affected by a hard reset caused by a CF9h write.</p> <p>0 = Disable.</p> <p>1 = Enables the setting of the RI_STS to generate a wake event.</p> <p>In addition to being cleared by RTCRST# assertion, the PCH also clears this bit due to a Power Button Override event, Intel ME Initiated Power Button Override, Intel ME Initiated Host Reset with Power down, SMBus unconditional power down, processor thermal trip event, or due to an internal thermal sensor catastrophic condition.</p>
7	Reserved
6	<p>TCOSCI_EN — R/W.</p> <p>0 = Disable.</p> <p>1 = Enables the setting of the TCOSCI_STS to generate an SCI.</p> <p>In addition to being cleared by RSMRST# assertion, the PCH also clears this bit due to a Power Button Override event, Intel ME Initiated Power Button Override, Intel ME Initiated Host Reset with Power down, SMBus unconditional power down, processor thermal trip event, or due to an internal thermal sensor catastrophic condition.</p>
5:3	Reserved
2	<p>SWGPE_EN— R/W. This bit allows software to control the assertion of SWGPE_STS bit. This bit, when set to 1, enables the SW GPE function. If SWGPE_CTRL is written to a 1, hardware will set SWGPE_STS (acts as a level input)</p> <p>If SWGPE_STS, SWGPE_EN, and SCI_EN are all 1's, an SCI will be generated</p> <p>If SWGPE_STS = 1, SWGPE_EN = 1, SCI_EN = 0, and GBL_SMI_EN = 1 then an SMI# will be generated</p>
1	<p>HOT_PLUG_EN — R/W.</p> <p>0 = Disables SCI generation upon the HOT_PLUG_STS bit being set.</p> <p>1 = Enables the PCH to cause an SCI when the HOT_PLUG_STS bit is set. This is used to allow the PCI Express ports to cause an SCI due to hot-plug events.</p>
0	Reserved



13.8.3.7 SMI_EN—SMI Control and Enable Register

I/O Address:	PMBASE + 30h	Attribute:	R/W, R/WO, WO
Default Value:	00000002h	Size:	32 bit
Lockable:	No	Usage:	ACPI or Legacy
Power Well:	Core		

Note: This register is symmetrical to the SMI status register.

Bit	Description
31:28	Reserved
27	GPIO_UNLOCK_SMI_EN — R/WO. Setting this bit will cause the PCH to generate an SMI# when the GPIO_UNLOCK_SMI_STS bit is set in the SMI_STS register. Once written to 1, this bit can only be cleared by PLTRST#.
26:19	Reserved
18	INTEL_USB2_EN — R/W. 0 = Disable 1 = Enables Intel-Specific EHCI SMI logic to cause SMI#.
17	LEGACY_USB2_EN — R/W. 0 = Disable 1 = Enables legacy EHCI logic to cause SMI#.
16:15	Reserved
14	PERIODIC_EN — R/W. 0 = Disable. 1 = Enables the PCH to generate an SMI# when the PERIODIC_STS bit (PMBASE + 34h, bit 14) is set in the SMI_STS register (PMBASE + 34h).
13	TCO_EN — R/W. 0 = Disables TCO logic generating an SMI#. Note that if the NMI2SMI_EN bit is set, SMIs that are caused by re-routed NMIs will not be gated by the TCO_EN bit. Even if the TCO_EN bit is 0, NMIs will still be routed to cause SMIs. 1 = Enables the TCO logic to generate SMI#. NOTE: This bit cannot be written once the TCO_LOCK bit is set.
12	Reserved
11	MCSMI_EN Microcontroller SMI Enable (MCSMI_EN) — R/W. 0 = Disable. 1 = Enables PCH to trap accesses to the microcontroller range (62h or 66h) and generate an SMI#. Note that “trapped” cycles will be claimed by the PCH on PCI, but not forwarded to LPC.
10:8	Reserved
7	BIOS Release (BIOS_RLS) — WO. 0 = This bit will always return 0 on reads. Writes of 0 to this bit have no effect. 1 = Enables the generation of an SCI interrupt for ACPI software when a one is written to this bit position by BIOS software. NOTE: GBL_STS being set will cause an SCI, even if the SCI_EN bit is not set. Software must take great care not to set the BIOS_RLS bit (which causes GBL_STS to be set) if the SCI handler is not in place.



Bit	Description
6	<p>Software SMI# Timer Enable (SWSMI_TMR_EN) — R/W.</p> <p>0 = Disable. Clearing the SWSMI_TMR_EN bit before the timer expires will reset the timer and the SMI# will not be generated.</p> <p>1 = Starts Software SMI# Timer. When the SWSMI timer expires (the timeout period depends upon the SWSMI_RATE_SEL bit setting), SWSMI_TMR_STS is set and an SMI# is generated. SWSMI_TMR_EN stays set until cleared by software.</p>
5	<p>APMC_EN — R/W.</p> <p>0 = Disable. Writes to the APM_CNT register will not cause an SMI#.</p> <p>1 = Enables writes to the APM_CNT register to cause an SMI#.</p>
4	<p>SLP_SMI_EN — R/W.</p> <p>0 = Disables the generation of SMI# on SLP_EN. Note that this bit must be 0 before the software attempts to transition the system into a sleep state by writing a 1 to the SLP_EN bit.</p> <p>1 = A write of 1 to the SLP_EN bit (bit 13 in PM1_CNT register) will generate an SMI#, and the system will not transition to the sleep state based on that write to the SLP_EN bit.</p>
3	<p>LEGACY_USB_EN — R/W.</p> <p>0 = Disable.</p> <p>1 = Enables legacy USB circuit to cause SMI#.</p>
2	<p>BIOS_EN — R/W.</p> <p>0 = Disable.</p> <p>1 = Enables the generation of SMI# when ACPI software writes a 1 to the GBL_RLS bit (D31:F0:PMBase + 04h:bit 2). Note that if the BIOS_STS bit (D31:F0:PMBase + 34h:bit 2), which gets set when software writes 1 to GBL_RLS bit, is already a 1 at the time that BIOS_EN becomes 1, an SMI# will be generated when BIOS_EN gets set.</p>
1	<p>End of SMI (EOS) — R/W (special). This bit controls the arbitration of the SMI signal to the processor. This bit must be set for the PCH to assert SMI# low to the processor after SMI# has been asserted previously.</p> <p>0 = Once the PCH asserts SMI# low, the EOS bit is automatically cleared.</p> <p>1 = When this bit is set to 1, SMI# signal will be deasserted for 4 PCI clocks before its assertion. In the SMI handler, the processor should clear all pending SMIs (by servicing them and then clearing their respective status bits), set the EOS bit, and exit SMM. This will allow the SMI arbiter to re-assert SMI upon detection of an SMI event and the setting of a SMI status bit.</p> <p>NOTE: The PCH is able to generate 1st SMI after reset even though EOS bit is not set. Subsequent SMI require EOS bit is set.</p>
0	<p>GBL_SMI_EN — R/W.</p> <p>0 = No SMI# will be generated by PCH. This bit is reset by a PCI reset event.</p> <p>1 = Enables the generation of SMI# in the system upon any enabled SMI event.</p> <p>NOTE: When the SMI_LOCK bit is set, this bit cannot be changed.</p>



13.8.3.8 SMI_STS—SMI Status Register

I/O Address:	PMBASE + 34h	Attribute:	RO, R/WC
Default Value:	00000000h	Size:	32-bit
Lockable:	No	Usage:	ACPI or Legacy
Power Well:	Core		

Note: If the corresponding `_EN` bit is set when the `_STS` bit is set, the PCH will cause an SMI# (except bits 8–10 and 12, which do not need enable bits since they are logic ORs of other registers that have enable bits). The PCH uses the same GPE0_EN register (I/O address: PMBase+2Ch) to enable/disable both SMI and ACPI SCI general purpose input events. ACPI OS assumes that it owns the entire GPE0_EN register per the ACPI specification. Problems arise when some of the general-purpose inputs are enabled as SMI by BIOS, and some of the general purpose inputs are enabled for SCI. In this case ACPI OS turns off the enabled bit for any GPIx input signals that are not indicated as SCI general-purpose events at boot, and exit from sleeping states. BIOS should define a dummy control method which prevents the ACPI OS from clearing the SMI GPE0_EN bits.

Bit	Description
31:28	Reserved
27	GPIO_UNLOCK_SMI_STS — R/WC. This bit will be set if the GPIO registers lockdown logic is requesting an SMI#. Writing a 1 to this bit position clears this bit to 0.
26	SPI_STS — RO. This bit will be set if the SPI logic is generating an SMI#. This bit is read only because the sticky status and enable bits associated with this function are located in the SPI registers.
25:22	Reserved
21	MONITOR_STS — RO. This bit will be set if the Trap/SMI logic has caused the SMI. This will occur when the processor or a bus master accesses an assigned register (or a sequence of accesses). See Section 10.1.20 through Section 10.1.34 for details on the specific cause of the SMI.
20	PCI_EXP_SMI_STS — RO. PCI Express* SMI event occurred. This could be due to a PCI Express PME event or Hot-Plug event.
19	Reserved
18	INTEL_USB2_STS — RO. This non-sticky read-only bit is a logical OR of each of the SMI status bits in the Intel-Specific EHCI SMI Status Register ANDed with the corresponding enable bits. This bit will not be active if the enable bits are not set. Writes to this bit will have no effect. All integrated EHCIs are represented with this bit.
17	LEGACY_USB2_STS — RO. This non-sticky read-only bit is a logical OR of each of the SMI status bits in the EHCI Legacy Support Register ANDed with the corresponding enable bits. This bit will not be active if the enable bits are not set. Writes to this bit will have no effect. All integrated EHCIs are represented with this bit.



Bit	Description
16	<p>SMBus SMI Status (SMBUS_SMI_STS) — R/WC. Software clears this bit by writing a 1 to it.</p> <p>0 = This bit is set from the 64 kHz clock domain used by the SMBus. Software must wait at least 15.63 μs after the initial assertion of this bit before clearing it.</p> <p>1 = Indicates that the SMI# was caused by:</p> <ol style="list-style-type: none"> 1. The SMBus Slave receiving a message that an SMI# should be caused, or 2. The SMBALERT# signal goes active and the SMB_SMI_EN bit is set and the SMBALERT_DIS bit is cleared, or 3. The SMBus Slave receiving a Host Notify message and the HOST_NOTIFY_INTREN and the SMB_SMI_EN bits are set, or 4. The PCH detecting the SMLINK_SLAVE_SMI command while in the S0 state.
15	<p>SERIRQ_SMI_STS — RO.</p> <p>0 = SMI# was not caused by the SERIRQ decoder.</p> <p>1 = Indicates that the SMI# was caused by the SERIRQ decoder.</p> <p>NOTE: This is not a sticky bit</p>
14	<p>PERIODIC_STS — R/WC. Software clears this bit by writing a 1 to it.</p> <p>0 = Software clears this bit by writing a 1 to it.</p> <p>1 = This bit is set at the rate determined by the PER_SMI_SEL bits. If the PERIODIC_EN bit (PMBASE + 30h, bit 14) is also set, the PCH generates an SMI#.</p>
13	<p>TCO_STS — R/WC. Software clears this bit by writing a 1 to it.</p> <p>0 = SMI# not caused by TCO logic.</p> <p>1 = Indicates the SMI# was caused by the TCO logic. Note that this is not a wake event.</p>
12	<p>Device Monitor Status (DEVMON_STS) — RO.</p> <p>0 = SMI# not caused by Device Monitor.</p> <p>1 = Set if bit 0 of the DEVACT_STS register (PMBASE + 44h) is set. The bit is not sticky, so writes to this bit will have no effect.</p>
11	<p>Microcontroller SMI# Status (MCSMI_STS) — R/WC. Software clears this bit by writing a 1 to it.</p> <p>0 = Indicates that there has been no access to the power management microcontroller range (62h or 66h).</p> <p>1 = Set if there has been an access to the power management microcontroller range (62h or 66h) and the Microcontroller Decode Enable #1 bit in the LPC Bridge I/O Enables configuration register is 1 (D31:F0:Offset 82h:bit 11). Note that this implementation assumes that the Microcontroller is on LPC. If this bit is set, and the MCSMI_EN bit is also set, the PCH will generate an SMI#.</p>
10	<p>GPE0_STS — RO. This bit is a logical OR of the bits in the ALT_GP_SMI_STS register that are also set up to cause an SMI# (as indicated by the GPI_ROUT registers) and have the corresponding bit set in the ALT_GP_SMI_EN register. Bits that are not routed to cause an SMI# will have no effect on this bit.</p> <p>0 = SMI# was not generated by a GPI assertion.</p> <p>1 = SMI# was generated by a GPI assertion.</p>
9	<p>GPE0_STS — RO. This bit is a logical OR of the bits 47:32, 14:10, 8, 6:2, and 0 in the GPE0_STS register (PMBASE + 28h) that also have the corresponding bit set in the GPE0_EN register (PMBASE + 2Ch).</p> <p>0 = SMI# was not generated by a GPE0 event.</p> <p>1 = SMI# was generated by a GPE0 event.</p>
8	<p>PM1_STS_REG — RO. This is an ORs of the bits in the ACPI PM1 Status Register (offset PMBASE+00h) that can cause an SMI#.</p> <p>0 = SMI# was not generated by a PM1_STS event.</p> <p>1 = SMI# was generated by a PM1_STS event.</p>



Bit	Description
7	Reserved
6	SWSMI_TMR_STS — R/WC. Software clears this bit by writing a 1 to it. 0 = Software SMI# Timer has Not expired. 1 = Set by the hardware when the Software SMI# Timer expires.
5	APM_STS — R/WC. Software clears this bit by writing a 1 to it. 0 = No SMI# generated by write access to APM Control register with APMCH_EN bit set. 1 = SMI# was generated by a write access to the APM Control register with the APMC_EN bit set.
4	SLP_SMI_STS — R/WC. Software clears this bit by writing a 1 to the bit location. 0 = No SMI# caused by write of 1 to SLP_EN bit when SLP_SMI_EN bit is also set. 1 = Indicates an SMI# was caused by a write of 1 to SLP_EN bit when SLP_SMI_EN bit is also set.
3	LEGACY_USB_STS — RO. This bit is a logical OR of each of the SMI status bits in the USB Legacy Keyboard/Mouse Control Registers ANDed with the corresponding enable bits. This bit will not be active if the enable bits are not set. 0 = SMI# was not generated by USB Legacy event. 1 = SMI# was generated by USB Legacy event.
2	BIOS_STS — R/WC. 0 = No SMI# generated due to ACPI software requesting attention. 1 = This bit gets set by hardware when a 1 is written by software to the GBL_RLS bit (D31:F0:PMBase + 04h:bit 2). When both the BIOS_EN bit (D31:F0:PMBase + 30h:bit 2) and the BIOS_STS bit are set, an SMI# will be generated. The BIOS_STS bit is cleared when software writes a 1 to its bit position.
1:0	Reserved

13.8.3.9 ALT_GP_SMI_EN—Alternate GPI SMI Enable Register

I/O Address:	PMBASE +38h	Attribute:	R/W
Default Value:	0000h	Size:	16-bit
Lockable:	No	Usage:	ACPI or Legacy
Power Well:	Resume		

Bit	Description
15:0	Alternate GPI SMI Enable — R/W. These bits are used to enable the corresponding GPIO to cause an SMI#. For these bits to have any effect, the following must be true. <ul style="list-style-type: none"> The corresponding bit in the ALT_GP_SMI_EN register is set. The corresponding GPI must be routed in the GPI_ROUT register to cause an SMI. The corresponding GPIO must be implemented. NOTE: Mapping is as follows: bit 15 corresponds to GPIO15... bit 0 corresponds to GPIO0.



13.8.3.10 ALT_GP_SMI_STS—Alternate GPI SMI Status Register

I/O Address:	PMBASE +3Ah	Attribute:	R/WC
Default Value:	0000h	Size:	16-bit
Lockable:	No	Usage:	ACPI or Legacy
Power Well:	Resume		

Bit	Description
15:0	<p>Alternate GPI SMI Status — R/WC. These bits report the status of the corresponding GPIOs.</p> <p>0 = Inactive. Software clears this bit by writing a 1 to it. 1 = Active</p> <p>These bits are sticky. If the following conditions are true, then an SMI# will be generated and the GPE0_STS bit set:</p> <ul style="list-style-type: none"> The corresponding bit in the ALT_GPI_SMI_EN register (PMBASE + 38h) is set The corresponding GPIO must be routed in the GPI_ROUT register to cause an SMI. The corresponding GPIO must be implemented. <p>All bits are in the resume well. Default for these bits is dependent on the state of the GPIO pins.</p>

13.8.3.11 GPE_CNTL—General Purpose Control Register

I/O Address:	PMBASE +42h	Attribute:	R/W
Default Value:	00h	Size:	8-bit
Lockable:	No	Usage:	ACPI or Legacy
Power Well:	Bits 0–1, 3–7: Resume Bit 2: RTC		

Bit	Description
7:2	Reserved
2	<p>GPIO27_POL — R/W. This bit controls the polarity of the GPIO27 pin needed to set the GPIO27_STS bit.</p> <p>0 = GPIO27 = 0 will set the GPIO27_STS bit. 1 = GPIO27 = 1 will set the GPIO27_STS bit</p> <p>This bit is cleared by RTCRST# assertion.</p>
1	<p>SWGPE_CTRL— R/W. This bit allows software to control the assertion of SWGPE_STS bit. This bit is used by hardware as the level input signal for the SWGPE_STS bit in the GPE0_STS register. When SWGPE_CTRL is 1, SWGPE_STS will be set to 1, and writes to SWGPE_STS with a value of 1 to clear SWGPE_STS will result in SWGPE_STS being set back to 1 by hardware. When SWGPE_CTRL is 0, writes to SWGPE_STS with a value of 1 will clear SWGPE_STS to 0.</p> <p>In addition to being cleared by RSMRST# assertion, the PCH also clears this bit due to a Power Button Override event, Intel ME Initiated Power Button Override, Intel ME Initiated Host Reset with Power down, SMBus unconditional power down, processor thermal trip event, or due to an internal thermal sensor catastrophic condition.</p>
0	Reserved



13.8.3.12 DEVACT_STS – Device Activity Status Register

I/O Address:	PMBASE + 44h	Attribute:	R/WC
Default Value:	0000h	Size:	16-bit
Lockable:	No	Usage:	Legacy Only
Power Well:	Core		

Each bit indicates if an access has occurred to the corresponding device's trap range, or for bits 6:9 if the corresponding PCI interrupt is active. This register is used in conjunction with the Periodic SMI# timer to detect any system activity for legacy power management. The periodic SMI# timer indicates if it is the right time to read the DEVACT_STS register (PMBASE + 44h).

Note: Software clears bits that are set in this register by writing a 1 to the bit position.

Bit	Description
15:13	Reserved
12	KBC_ACT_STS – R/WC. KBC (60/64h). 0 = Indicates that there has been no access to this device I/O range. 1 = This device I/O range has been accessed. Clear this bit by writing a 1 to the bit location.
11:10	Reserved
9	PIRQDH_ACT_STS – R/WC. PIRQ[D or H]. 0 = The corresponding PCI interrupts have not been active. 1 = At least one of the corresponding PCI interrupts has been active. Clear this bit by writing a 1 to the bit location.
8	PIRQCG_ACT_STS – R/WC. PIRQ[C or G]. 0 = The corresponding PCI interrupts have not been active. 1 = At least one of the corresponding PCI interrupts has been active. Clear this bit by writing a 1 to the bit location.
7	PIRQBF_ACT_STS – R/WC. PIRQ[B or F]. 0 = The corresponding PCI interrupts have not been active. 1 = At least one of the corresponding PCI interrupts has been active. Clear this bit by writing a 1 to the bit location.
6	PIRQAE_ACT_STS – R/WC. PIRQ[A or E]. 0 = The corresponding PCI interrupts have not been active. 1 = At least one of the corresponding PCI interrupts has been active. Clear this bit by writing a 1 to the bit location.
5:0	Reserved

13.8.3.13 PM2_CNT–Power Management 2 Control Register

I/O Address:	PMBASE + 50h	Attribute:	R/W
Default Value:	00h	Size:	8-bit
Lockable:	No	Usage:	ACPI
Power Well:	Core		

Bit	Description
7:1	Reserved
0	Arbiter Disable (ARB_DIS) – R/W This bit is a scratchpad bit for legacy software compatibility.



13.9 System Management TCO Registers

The TCO logic is accessed using registers mapped to the PCI configuration space (Device 31:Function 0) and the system I/O space. For TCO PCI Configuration registers, see LPC Device 31:Function 0 PCI Configuration registers.

TCO Register I/O Map

The TCO I/O registers reside in a 32-byte range pointed to by a TCOBASE value, which is, PMBASE + 60h in the PCI config space. The following table shows the mapping of the registers within that 32-byte range. Each register is described in the following sections.

Table 13-12. TCO I/O Register Address Map

TCOBASE + Offset	Mnemonic	Register Name	Default	Attribute
00h–01h	TCO_RLD	TCO Timer Reload and Current Value	0000h	R/W
02h	TCO_DAT_IN	TCO Data In	00h	R/W
03h	TCO_DAT_OUT	TCO Data Out	00h	R/W
04h–05h	TCO1_STS	TCO1 Status	0000h	R/WC, RO
06h–07h	TCO2_STS	TCO2 Status	0000h	R/WC
08h–09h	TCO1_CNT	TCO1 Control	0000h	R/W, R/WLO, R/WC
0Ah–0Bh	TCO2_CNT	TCO2 Control	0008h	R/W
0Ch–0Dh	TCO_MESSAGE1, TCO_MESSAGE2	TCO Message 1 and 2	00h	R/W
0Eh	TCO_WDCNT	TCO Watchdog Control	00h	R/W
0Fh	—	Reserved	—	—
10h	SW_IRQ_GEN	Software IRQ Generation	03h	R/W
11h	—	Reserved	—	—
12h–13h	TCO_TMR	TCO Timer Initial Value	0004h	R/W
14h–1Fh	—	Reserved	—	—

13.9.1 TCO_RLD—TCO Timer Reload and Current Value Register

I/O Address: TCOBASE + 00h Attribute: R/W
 Default Value: 0000h Size: 16-bit
 Lockable: No Power Well: Core

Bit	Description
15:10	Reserved
9:0	TCO Timer Value — R/W. Reading this register will return the current count of the TCO timer. Writing any value to this register will reload the timer to prevent the timeout.



13.9.2 TCO_DAT_IN—TCO Data In Register

I/O Address: TCOBASE +02h Attribute: R/W
 Default Value: 00h Size: 8-bit
 Lockable: No Power Well: Core

Bit	Description
7:0	TCO Data In Value — R/W. This data register field is used for passing commands from the OS to the SMI handler. Writes to this register will cause an SMI and set the SW_TCO_SMI bit in the TCO1_STS register (D31:F0:04h).

13.9.3 TCO_DAT_OUT—TCO Data Out Register

I/O Address: TCOBASE +03h Attribute: R/W
 Default Value: 00h Size: 8-bit
 Lockable: No Power Well: Core

Bit	Description
7:0	TCO Data Out Value — R/W. This data register field is used for passing commands from the SMI handler to the OS. Writes to this register will set the TCO_INT_STS bit in the TCO1_STS register. It will also cause an interrupt, as selected by the TCO_INT_SEL bits.

13.9.4 TCO1_STS—TCO1 Status Register

I/O Address: TCOBASE +04h Attribute: R/WC, RO
 Default Value: 2000h Size: 16-bit
 Lockable: No Power Well: Core
 (Except bit 7, in RTC)

Bit	Description
15:14	Reserved
13	TCO_SLVSEL (TCO Slave Select) — RO. This register bit is Read Only by Host and indicates the value of TCO Slave Select Soft Strap. Refer to the PCH Soft Straps section of the SPI Chapter for details.
12	DMISERR_STS — R/WC. 0 = Software clears this bit by writing a 1 to it. 1 = PCH received a DMI special cycle message using DMI indicating that it wants to cause an SERR#. The software must read the processor to determine the reason for the SERR#.
11	Reserved
10	DMISMI_STS — R/WC. 0 = Software clears this bit by writing a 1 to it. 1 = PCH received a DMI special cycle message using DMI indicating that it wants to cause an SMI. The software must read the processor to determine the reason for the SMI.



Bit	Description
9	<p>DMISCI_STS — R/WC.</p> <p>0 = Software clears this bit by writing a 1 to it. 1 = PCH received a DMI special cycle message using DMI indicating that it wants to cause an SCI. The software must read the processor to determine the reason for the SCI.</p>
8	<p>BIOSWR_STS — R/WC.</p> <p>0 = Software clears this bit by writing a 1 to it. 1 = PCH sets this bit and generates and SMI# to indicate an invalid attempt to write to the BIOS. This occurs when either: a) The BIOSWP bit is changed from 0 to 1 and the BLD bit is also set, or b) any write is attempted to the BIOS and the BIOSWP bit is also set.</p> <p>NOTE: On write cycles attempted to the 4 MB lower alias to the BIOS space, the BIOSWR_STS will not be set.</p>
7	<p>NEWCENTURY_STS — R/WC. This bit is in the RTC well.</p> <p>0 = Cleared by writing a 1 to the bit position or by RTCRST# going active. 1 = This bit is set when the Year byte (RTC I/O space, index offset 09h) rolls over from 99 to 00. Setting this bit will cause an SMI# (but not a wake event).</p> <p>NOTE: The NEWCENTURY_STS bit is not valid when the RTC battery is first installed (or when RTC power has not been maintained). Software can determine if RTC power has not been maintained by checking the RTC_PWR_STS bit (D31:F0:A4h, bit 2), or by other means (such as a checksum on RTC RAM). If RTC power is determined to have not been maintained, BIOS should set the time to a valid value and then clear the NEWCENTURY_STS bit.</p> <p>The NEWCENTURY_STS bit may take up to 3 RTC clocks for the bit to be cleared after a 1 is written to the bit to clear it. After writing a 1 to this bit, software should not exit the SMI handler until verifying that the bit has actually been cleared. This will ensure that the SMI is not re-entered.</p>
6:4	Reserved
3	<p>TIMEOUT — R/WC.</p> <p>0 = Software clears this bit by writing a 1 to it. 1 = Set by PCH to indicate that the SMI was caused by the TCO timer reaching 0.</p>
2	<p>TCO_INT_STS — R/WC.</p> <p>0 = Software clears this bit by writing a 1 to it. 1 = SMI handler caused the interrupt by writing to the TCO_DAT_OUT register (TCOBASE + 03h).</p>
1	<p>SW_TCO_SMI — R/WC.</p> <p>0 = Software clears this bit by writing a 1 to it. 1 = Software caused an SMI# by writing to the TCO_DAT_IN register (TCOBASE + 02h).</p>
0	<p>NMI2SMI_STS — RO.</p> <p>0 = Cleared by clearing the associated NMI status bit. 1 = Set by the PCH when an SMI# occurs because an event occurred that would otherwise have caused an NMI (because NMI2SMI_EN is set).</p>



13.9.5 TCO2_STS—TCO2 Status Register

I/O Address:	TCOBASE +06h	Attribute:	R/WC
Default Value:	0000h	Size:	16-bit
Lockable:	No	Power Well:	Resume (Except Bit 0, in RTC)

Bit	Description
15:5	Reserved
4	<p>SMLink Slave SMI Status (SMLINK_SLV_SMI_STS) — R/WC. Allow the software to go directly into a pre-determined sleep state. This avoids race conditions. Software clears this bit by writing a 1 to it.</p> <p>0 = The bit is reset by RSMRST#, but not due to the PCI Reset associated with exit from S3–S5 states.</p> <p>1 = PCH sets this bit to 1 when it receives the SMI message on the SMLink Slave Interface.</p>
3	Reserved
2	<p>BOOT_STS — R/WC.</p> <p>0 = Cleared by PCH based on RSMRST# or by software writing a 1 to this bit. Note that software should first clear the SECOND_TO_STS bit before writing a 1 to clear the BOOT_STS bit.</p> <p>1 = Set to 1 when the SECOND_TO_STS bit goes from 0 to 1 and the processor has not fetched the first instruction.</p> <p>If rebooting due to a second TCO timer timeout, and if the BOOT_STS bit is set, the PCH will reboot using the 'safe' multiplier (1111). This allows the system to recover from a processor frequency multiplier that is too high, and allows the BIOS to check the BOOT_STS bit at boot. If the bit is set and the frequency multiplier is 1111, then the BIOS knows that the processor has been programmed to an invalid multiplier.</p>
1	<p>SECOND_TO_STS — R/WC.</p> <p>0 = Software clears this bit by writing a 1 to it, or by a RSMRST#.</p> <p>1 = PCH sets this bit to 1 to indicate that the TIMEOUT bit had been (or is currently) set and a second timeout occurred before the TCO_RLD register was written. If this bit is set and the NO_REBOOT config bit is 0, then the PCH will reboot the system after the second timeout. The reboot is done by asserting PLTRST#.</p>
0	<p>Intruder Detect (INTRD_DET) — R/WC.</p> <p>0 = Software clears this bit by writing a 1 to it, or by RTCRST# assertion.</p> <p>1 = Set by PCH to indicate that an intrusion was detected. This bit is set even if the system is in G3 state.</p> <p>NOTES:</p> <ol style="list-style-type: none"> This bit has a recovery time. After writing a 1 to this bit position (to clear it), the bit may be read back as a 1 for up to 65 microseconds before it is read as a 0. Software must be aware of this recovery time when reading this bit after clearing it. If the INTRUDER# signal is active when the software attempts to clear the INTRD_DET bit, the bit will remain as a 1, and the SMI# will be generated again immediately. The SMI handler can clear the INTRD_SEL bits (TCOBASE + 0Ah, bits 2:1), to avoid further SMIs. However, if the INTRUDER# signal goes inactive and then active again, there will not be further SMIs (because the INTRD_SEL bits would select that no SMI# be generated). If the INTRUDER# signal goes inactive some point after the INTRD_DET bit is written as a 1, then the INTRD_DET signal will go to a 0 when INTRUDER# input signal goes inactive. Note that this is slightly different than a classic sticky bit, since most sticky bits would remain active indefinitely when the signal goes active and would immediately go inactive when a 1 is written to the bit.

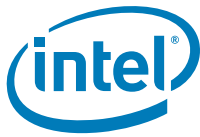

13.9.6 TCO1_CNT—TCO1 Control Register

I/O Address: TCOBASE +08h Attribute: R/W, R/WLO, R/WC
 Default Value: 0000h Size: 16-bit
 Lockable: No Power Well: Core

Bit	Description															
15:13	Reserved															
12	TCO_LOCK — R/WLO. When set to 1, this bit prevents writes from changing the TCO_EN bit (in offset 30h of Power Management I/O space). Once this bit is set to 1, it can not be cleared by software writing a 0 to this bit location. A core-well reset is required to change this bit from 1 to 0. This bit defaults to 0.															
11	TCO Timer Halt (TCO_TMR_HLT) — R/W. 0 = The TCO Timer is enabled to count. 1 = The TCO Timer will halt. It will not count, and thus cannot reach a value that will cause an SMI# or set the SECOND_TO_STS bit. When set, this bit will prevent rebooting and prevent Alert On LAN event messages from being transmitted on the SMLink (but not Alert On LAN* heartbeat messages).															
10	Reserved															
9	NMI2SMI_EN — R/W. 0 = Normal NMI functionality. 1 = Forces all NMIs to instead cause SMIs. The functionality of this bit is dependent upon the settings of the NMI_EN bit and the GBL_SMI_EN bit as detailed in the following table: <table border="1"> <thead> <tr> <th>NMI_EN</th> <th>GBL_SMI_EN</th> <th>Description</th> </tr> </thead> <tbody> <tr> <td>0b</td> <td>0b</td> <td>No SMI# at all because GBL_SMI_EN = 0</td> </tr> <tr> <td>0b</td> <td>1b</td> <td>SMI# will be caused due to NMI events</td> </tr> <tr> <td>1b</td> <td>0b</td> <td>No SMI# at all because GBL_SMI_EN = 0</td> </tr> <tr> <td>1b</td> <td>1b</td> <td>No SMI# due to NMI because NMI_EN = 1</td> </tr> </tbody> </table>	NMI_EN	GBL_SMI_EN	Description	0b	0b	No SMI# at all because GBL_SMI_EN = 0	0b	1b	SMI# will be caused due to NMI events	1b	0b	No SMI# at all because GBL_SMI_EN = 0	1b	1b	No SMI# due to NMI because NMI_EN = 1
NMI_EN	GBL_SMI_EN	Description														
0b	0b	No SMI# at all because GBL_SMI_EN = 0														
0b	1b	SMI# will be caused due to NMI events														
1b	0b	No SMI# at all because GBL_SMI_EN = 0														
1b	1b	No SMI# due to NMI because NMI_EN = 1														
8	NMI_NOW — R/WC. 0 = Software clears this bit by writing a 1 to it. The NMI handler is expected to clear this bit. Another NMI will not be generated until the bit is cleared. 1 = Writing a 1 to this bit causes an NMI. This allows the BIOS or SMI handler to force an entry to the NMI handler.															
7:0	Reserved															



13.9.7 TCO2_CNT—TCO2 Control Register

I/O Address: TCOBASE +0Ah Attribute: R/W
 Default Value: 0008h Size: 16-bit
 Lockable: No Power Well: Resume

Bit	Description
15:6	Reserved
5:4	<p>OS_POLICY — R/W. OS-based software writes to these bits to select the policy that the BIOS will use after the platform resets due the WDT. The following convention is recommended for the BIOS and OS:</p> <p>00 = Boot normally 01 = Shut down 10 = Do not load OS. Hold in pre-boot state and use LAN to determine next step 11 = Reserved</p> <p>NOTE: These are just scratchpad bits. They should not be reset when the TCO logic resets the platform due to Watchdog Timer.</p>
3	<p>GPIO11_ALERT_DISABLE — R/W. At reset (using RSMRST# asserted) this bit is set and GPIO[11] alerts are disabled.</p> <p>0 = Enable. 1 = Disable GPIO11/SMBALERT# as an alert source for the heartbeats and the SMBus slave.</p>
2:1	<p>INTRD_SEL — R/W. This field selects the action to take if the INTRUDER# signal goes active.</p> <p>00 = No interrupt or SMI# 01 = Interrupt (as selected by TCO_INT_SEL). 10 = SMI 11 = Reserved</p>
0	Reserved

13.9.8 TCO_MESSAGE1 and TCO_MESSAGE2 Registers

I/O Address: TCOBASE +0Ch (Message 1) Attribute: R/W
 TCOBASE +0Dh (Message 2)
 Default Value: 00h Size: 8-bit
 Lockable: No Power Well: Resume

Bit	Description
7:0	<p>TCO_MESSAGE[n] — R/W. BIOS can write into these registers to indicate its boot progress. The external microcontroller can read these registers to monitor the boot progress.</p>



13.9.9 TCO_WDCNT—TCO Watchdog Control Register

Offset Address: TCOBASE + 0Eh Attribute: R/W
Default Value: 00h Size: 8 bits
Power Well: Resume

Bit	Description
7:0	The BIOS or system management software can write into this register to indicate more details on the boot progress. The register will reset to 00h based on a RSMRST# (but not PLTRST#). The external microcontroller can read this register to monitor boot progress.

13.9.10 SW_IRQ_GEN—Software IRQ Generation Register

Offset Address: TCOBASE + 10h Attribute: R/W
Default Value: 03h Size: 8 bits
Power Well: Core

Bit	Description
7:2	Reserved
1	IRQ12_CAUSE — R/W. When software sets this bit to 1, IRQ12 will be asserted. When software sets this bit to 0, IRQ12 will be deasserted.
0	IRQ1_CAUSE — R/W. When software sets this bit to 1, IRQ1 will be asserted. When software sets this bit to 0, IRQ1 will be deasserted.

13.9.11 TCO_TMR—TCO Timer Initial Value Register

I/O Address: TCOBASE + 12h Attribute: R/W
Default Value: 0004h Size: 16-bit
Lockable: No Power Well: Core

Bit	Description
15:10	Reserved
9:0	TCO Timer Initial Value — R/W. Value that is loaded into the timer each time the TCO_RLD register is written. Values of 0000h or 0001h will be ignored and should not be attempted. The timer is clocked at approximately 0.6 seconds, and thus allows timeouts ranging from 1.2 second to 613.8 seconds. NOTE: The timer has an error of ± 1 tick (0.6 S). The TCO Timer will only count down in the S0 state.



13.10 General Purpose I/O Registers

The control for the general purpose I/O signals is handled through a 128-byte I/O space. The base offset for this space is selected by the GPIOBASE register.

Table 13-13. Registers to Control GPIO Address Map

GPIOBASE + Offset	Mnemonic	Register Name	Default	Attribute
00h-03h	GPIO_USE_SEL	GPIO Use Select	B96BA1FFh	R/W
04h-07h	GP_IO_SEL	GPIO Input/Output Select	F6FF6EFFh	R/W
08h-0Bh	—	Reserved	0h	—
0Ch-0Fh	GP_LVL	GPIO Level for Input or Output	02FE0100h	R/W
10h-13h	—	Reserved	0h	—
14h-17h	—	Reserved	0h	—
18h-1Bh	GPO_BLINK	GPIO Blink Enable	00040000h	R/W
1Ch-1Fh	GP_SER_BLINK	GP Serial Blink	00000000h	R/W
20h-23h	GP_SB_CMDSTS	GP Serial Blink Command Status	00080000h	R/W
24h-27h	GP_SB_DATA	GP Serial Blink Data	00000000h	R/W
28h-29h	GPI_NMI_EN	GPI NMI Enable	0000h	R/W
2Ah-2Bh	GPI_NMI_STS	GPI NMI Status	0000h	R/WC
2Ch-2Fh	GPI_INV	GPIO Signal Invert	00000000h	R/W
30h-33h	GPIO_USE_SEL2	GPIO Use Select 2	020300FEh (mobile only) / 020300FFh (Desktop only)	R/W
34h-37h	GP_IO_SEL2	GPIO Input/Output Select 2	1F57FFF4h	R/W
38h-3Bh	GP_LVL2	GPIO Level for Input or Output 2	A4AA0007h	R/W
3Ch-3Fh	—	Reserved	0h	—
40h-43h	GPIO_USE_SEL3	GPIO Use Select 3	00000030h (mobile only) / 00000130h (desktop only)	R/W
44h-47h	GPIO_SEL3	GPIO Input/Output Select 3	00000F00h	R/W
48h-4Bh	GP_LVL3	GPIO Level for Input or Output 3	000000C0h	R/W
4Ch-5Fh	—	Reserved	—	—
60h-63h	GP_RST_SEL1	GPIO Reset Select 1	01000000h	R/W
64h-67h	GP_RST_SEL2	GPIO Reset Select 2	00000000h	R/W
68h-6Bh	GP_RST_SEL3	GPIO Reset Select 3	00000000h	R/W
6Ch-7Fh	—	Reserved	—	—



13.10.1 GPIO_USE_SEL—GPIO Use Select Register

Offset Address:	GPIOBASE + 00h	Attribute:	R/W
Default Value:	B96BA1FFh	Size:	32-bit
Lockable:	Yes	Power Well:	Core for 0:7, 16:23, Resume for 8:15, 24:31

Bit	Description
31:0	<p>GPIO_USE_SEL[31:0] — R/W. Each bit in this register enables the corresponding GPIO (if it exists) to be used as a GPIO, rather than for the native function.</p> <p>0 = Signal used as native function. 1 = Signal used as a GPIO.</p> <p>NOTES:</p> <ol style="list-style-type: none"> The following bits are always 1 because they are always unmultiplexed: 8, 15, 24, 27, and 28. After a full reset (RSMRST#) all multiplexed signals in the resume and core wells are configured as their default function. After only a PLTRST#, the GPIOs in the core well are configured as their default function. When configured to GPIO mode, the multiplexing logic will present the inactive state to native logic that uses the pin as an input. By default, all GPIOs are reset to the default state by CF9h reset except GPIO24. Other resume well GPIOs' reset behavior can be programmed using GP_RST_SEL registers. Bit 29 can be configured to GPIO when SLP_LAN#/GPIO29 Select Soft-strap is set to 1 (GPIO usage). GPIO18, GPIO25, and GPIO26 are mobile only GPIOs.

13.10.2 GP_IO_SEL—GPIO Input/Output Select Register

Offset Address:	GPIOBASE +04h	Attribute:	R/W
Default Value:	F6FF6EFFh	Size:	32-bit
Lockable:	Yes	Power Well:	Core for 0:7, 16:23, Resume for 8:15, 24:31

Bit	Description
31:0	<p>GP_IO_SEL[31:0] — R/W.</p> <p>When configured in native mode (GPIO_USE_SEL[n] is 0), writes to these bits have no effect. The value reported in this register is undefined when programmed as native mode.</p> <p>0 = Output. The corresponding GPIO signal is an output. 1 = Input. The corresponding GPIO signal is an input.</p>



13.10.3 GP_LVL—GPIO Level for Input or Output Register

Offset Address:	GPIOBASE +0Ch	Attribute:	R/W
Default Value:	02FE0100h	Size:	32-bit
Lockable:	Yes	Power Well:	Core for 0:7, 16:23, Resume for 8:15, 24:31

Bit	Description
31:0	<p>GP_LVL[31:0]— R/W. These registers are implemented as dual read/write with dedicated storage each. Write value will be stored in the write register, while read is coming from the read register which will always reflect the value of the pin.</p> <p>If GPIO[n] is programmed to be an output (using the corresponding bit in the GP_IO_SEL register), then the corresponding GP_LVL[n] write register value will drive a high or low value on the output pin. 1 = high, 0 = low.</p> <p>When configured in native mode (GPIO_USE_SEL[n] is 0), writes to these bits are stored but have no effect to the pin value. The value reported in this register is undefined when programmed as native mode.</p> <p>NOTE: Bit 29 setting will be ignored if Intel ME FW is configuring SLP_LAN# behavior. When GPIO29/SLP_LAN# Select Soft-strap is set to 1 (GPIO usage), bit 29 can be used as regular GP_LVL bit.</p>

13.10.4 GPO_BLINK—GPO Blink Enable Register

Offset Address:	GPIOBASE +18h	Attribute:	R/W
Default Value:	00040000h	Size:	32-bit
Lockable:	No	Power Well:	Core for 0:7, 16:23, Resume for 8:15, 24:31

Bit	Description
31:0	<p>GPO_BLINK[31:0] — R/W. The setting of this bit has no effect if the corresponding GPIO signal is programmed as an input.</p> <p>0 = The corresponding GPIO will function normally.</p> <p>1 = If the corresponding GPIO is programmed as an output, the output signal will blink at a rate of approximately once per second. The high and low times have approximately 0.5 seconds each. The GP_LVL bit is not altered when this bit is set.</p> <p>The value of the corresponding GP_LVL bit remains unchanged during the blink process, and does not effect the blink in any way. The GP_LVL bit is not altered when programmed to blink. It will remain at its previous value.</p> <p>These bits correspond to GPIO in the Resume well. These bits revert to the default value based on RSMRST# or a write to the CF9h register (but not just on PLTRST#).</p>

NOTE: GPIO18 will blink by default immediately after reset. This signal could be connected to an LED to indicate a failed boot (by programming BIOS to clear GP_BLINK18 after successful POST).



13.10.5 GP_SER_BLINK—GP Serial Blink Register

Offset Address:	GPIOBASE +1Ch	Attribute:	R/W
Default Value:	00000000h	Size:	32-bit
Lockable:	No	Power Well:	Core for 0:7, 16:23, Resume for 8:15, 24:31

Bit	Description
31:0	<p>GP_SER_BLINK[31:0] — R/W. The setting of this bit has no effect if the corresponding GPIO is programmed as an input or if the corresponding GPIO has the GPO_BLINK bit set.</p> <p>When set to a 0, the corresponding GPIO will function normally.</p> <p>When using serial blink, this bit should be set to a 1 while the corresponding GP_IO_SEL bit is set to 1. Setting the GP_IO_SEL bit to 0 after the GP_SER_BLINK bit ensures PCH will not drive a 1 on the pin as an output. When this corresponding bit is set to a 1 and the pin is configured to output mode, the serial blink capability is enabled. The PCH will serialize messages through an open-drain buffer configuration. The value of the corresponding GP_LVL bit remains unchanged and does not impact the serial blink capability in any way.</p> <p>Writes to this register have no effect when the corresponding pin is configured in native mode and the read value returned is undefined.</p>

13.10.6 GP_SB_CMDSTS—GP Serial Blink Command Status Register

Offset Address:	GPIOBASE +20h	Attribute:	R/W, RO
Default Value:	00080000h	Size:	32-bit
Lockable:	No	Power Well:	Core

Bit	Description
31:24	Reserved
23:22	<p>Data Length Select (DLS) — R/W. This field determines the number of bytes to serialize on GPIO.</p> <p>00 = Serialize bits 7:0 of GP_SB_DATA (1 byte)</p> <p>01 = Serialize bits 15:0 of GP_SB_DATA (2 bytes)</p> <p>10 = Undefined – Software must not write this value</p> <p>11 = Serialize bits 31:0 of GP_SB_DATA (4 bytes)</p> <p>Software should not modify the value in this register unless the Busy bit is clear. Writes to this register have no effect when the corresponding pin is configured in native mode and the read value returned is undefined.</p>
21:16	<p>Data Rate Select (DRS) — R/W. This field selects the number of 120ns time intervals to count between Manchester data transitions. The default of 8h results in a 960 ns minimum time between transitions. A value of 0h in this register produces undefined behavior.</p> <p>Software should not modify the value in this register unless the Busy bit is clear.</p>
15:9	Reserved
8	<p>Busy — RO. This read-only status bit is the hardware indication that a serialization is in progress. Hardware sets this bit to 1 based on the Go bit being set. Hardware clears this bit when the Go bit is cleared by the hardware.</p>
7:1	Reserved
0	<p>Go — R/W. This bit is set to 1 by software to start the serialization process. Hardware clears the bit after the serialized data is sent. Writes of 0 to this register have no effect. Software should not write this bit to 1 unless the Busy status bit is cleared.</p>



13.10.12 GP_IO_SEL2—GPIO Input/Output Select 2 Register

Offset Address:	GPIOBASE +34h	Attribute:	R/W
Default Value:	1F57FFF4h	Power Well:	Core for 0:7, 16:23, Resume for 8:15, 24:31
Lockable:	Yes		

Bit	Description
31:0	<p>GP_IO_SEL2[63:32] — R/W.</p> <p>0 = GPIO signal is programmed as an output. 1 = Corresponding GPIO signal (if enabled in the GPIO_USE_SEL2 register) is programmed as an input.</p> <p>This register corresponds to GPIO[63:32]. Bit 0 corresponds to GPIO32.</p>

13.10.13 GP_LVL2—GPIO Level for Input or Output 2 Register

Offset Address:	GPIOBASE +38h	Attribute:	R/W
Default Value:	A4AA0007h	Size:	32-bit
Lockable:	Yes	Power Well:	Core for 0:7, 16:23, Resume for 8:15, 24:31

Bit	Description
31:0	<p>GP_LVL[63:32] — R/W. These registers are implemented as dual read/write with dedicated storage each. Write value will be stored in the write register, while read is coming from the read register which will always reflect the value of the pin. If GPIO[n] is programmed to be an output (using the corresponding bit in the GP_IO_SEL register), then the corresponding GP_LVL[n] write register value will drive a high or low value on the output pin. 1 = high, 0 = low.</p> <p>When configured in native mode (GPIO_USE_SEL[n] is 0), writes to these bits are stored but have no effect to the pin value. The value reported in this register is undefined when programmed as native mode.</p> <p>NOTE: This register corresponds to GPIO[63:32]. Bit 0 corresponds to GPIO32.</p>



13.10.16 GP_LVL3—GPIO Level for Input or Output 3 Register

Offset Address:	GPIOBASE +48h	Attribute:	R/W
Default Value:	000000C0h	Size:	32-bit
Lockable:	Yes	Power Well:	Core for 0:7, 16:23, Resume for 8:15, 24:31

Bit	Description
31:12	Always 0. No corresponding GPIO.
11:8	<p>GP_LVL[75:72]— R/W.</p> <p>These registers are implemented as dual read/write with dedicated storage each. Write value will be stored in the write register, while read is coming from the read register which will always reflect the value of the pin. If GPIO[n] is programmed to be an output (using the corresponding bit in the GP_IO_SEL register), then the corresponding GP_LVL[n] write register value will drive a high or low value on the output pin. 1 = high, 0 = low.</p> <p>When configured in native mode (GPIO_USE_SEL[n] is 0), writes to these bits are stored but have no effect to the pin value. The value reported in this register is undefined when programmed as native mode.</p>
7:4	Always 0. No corresponding GPIO.
3:0	<p>GP_LVL[67:64] — R/W.</p> <p>These registers are implemented as dual read/write with dedicated storage each. Write value will be stored in the write register, while read is coming from the read register which will always reflect the value of the pin. If GPIO[n] is programmed to be an output (using the corresponding bit in the GP_IO_SEL register), then the corresponding GP_LVL[n] write register value will drive a high or low value on the output pin. 1 = high, 0 = low.</p> <p>When configured in native mode (GPIO_USE_SEL[n] is 0), writes to these bits are stored but have no effect to the pin value. The value reported in this register is undefined when programmed as native mode.</p> <p>This register corresponds to GPIO[95:64]. Bit 0 corresponds to GPIO64.</p>

13.10.17 GP_RST_SEL1—GPIO Reset Select Register

Offset Address:	GPIOBASE +60h	Attribute:	R/W
Default Value:	01000000h	Size:	32-bit
Lockable:	Yes	Power Well:	Core for 0:7, 16:23, Resume for 8:15, 24:31

Bit	Description
31:24	<p>GP_RST_SEL[31:24] — R/W.</p> <p>0 = Corresponding GPIO registers will be reset by PWROK deassertion, CF9h reset (06h or 0Eh), or SYS_RESET# assertion.</p> <p>1 = Corresponding GPIO registers will be reset by RSMRST# assertion only.</p> <p>NOTE: GPIO[24] register bits are not cleared by CF9h reset by default.</p>
23:16	Reserved
15:8	<p>GP_RST_SEL[15:8] — R/W.</p> <p>0 = Corresponding GPIO registers will be reset by PWROK deassertion, CF9h reset (06h or 0Eh), or SYS_RESET# assertion.</p> <p>1 = Corresponding GPIO registers will be reset by RSMRST# assertion only.</p>
7:0	Reserved

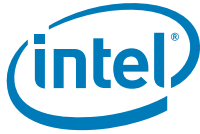

13.10.18 GP_RST_SEL2—GPIO Reset Select Register

Offset Address: GPIOBASE +64h Attribute: R/W
Default Value: 00000000h Size: 32-bit
Lockable: Yes Power Well: Core for 0:7, 16:23,
Resume for 8:15, 24:31

Bit	Description
31:24	GP_RST_SEL[63:56] — R/W. 0 = Corresponding GPIO registers will be reset by PWROK deassertion, CF9h reset (06h or 0Eh), or SYS_RESET# assertion. 1 = Corresponding GPIO registers will be reset by RSMRST# assertion only.
23:16	Reserved
15:8	GP_RST_SEL[47:40] — R/W. 0 = Corresponding GPIO registers will be reset by PWROK deassertion, CF9h reset (06h or 0Eh), or SYS_RESET# assertion. 1 = Corresponding GPIO registers will be reset by RSMRST# assertion only.
7:0	Reserved

13.10.19 GP_RST_SEL3—GPIO Reset Select Register

Offset Address: GPIOBASE +68h Attribute: R/W
Default Value: 00000000h Size: 32-bit
Lockable: Yes Power Well: Core for 0:7, 16:23,
Resume for 8:15, 24:31

Bit	Description
31:12	Reserved
11:8	GP_RST_SEL[75:72] — R/W. 0 = Corresponding GPIO registers will be reset by PWROK deassertion, CF9h reset (06h or 0Eh), or SYS_RESET# assertion. 1 = Corresponding GPIO registers will be reset by RSMRST# assertion only.
7:0	Reserved

§ §



14 SATA Controller Registers (D31:F2)

14.1 PCI Configuration Registers (SATA–D31:F2)

Note: Address locations that are not shown should be treated as Reserved.

All of the SATA registers are in the core well. None of the registers can be locked.

Table 14-1. SATA Controller PCI Register Address Map (SATA–D31:F2) (Sheet 1 of 2)

Offset	Mnemonic	Register Name	Default	Attribute
00h–01h	VID	Vendor Identification	8086h	RO
02h–03h	DID	Device Identification	See register description	RO
04h–05h	PCICMD	PCI Command	0000h	R/W, RO
06h–07h	PCISTS	PCI Status	02B0h	R/WC, RO
08h	RID	Revision Identification	See register description	RO
09h	PI	Programming Interface	See register description	See register description
0Ah	SCC	Sub Class Code	See register description	See register description
0Bh	BCC	Base Class Code	01h	RO
0Dh	PMLT	Primary Master Latency Timer	00h	RO
0Eh	HTYPE	Header Type	00h	RO
10h–13h	PCMD_BAR	Primary Command Block Base Address	00000001h	R/W, RO
14h–17h	PCNL_BAR	Primary Control Block Base Address	00000001h	R/W, RO
18h–1Bh	SCMD_BAR	Secondary Command Block Base Address	00000001h	R/W, RO
1Ch–1Fh	SCNL_BAR	Secondary Control Block Base Address	00000001h	R/W, RO
20h–23h	BAR	Legacy Bus Master Base Address	00000001h	R/W, RO
24h–27h	ABAR / SIDPBA	AHCI Base Address / SATA Index Data Pair Base Address	See register description	See register description
2Ch–2Dh	SVID	Subsystem Vendor Identification	0000h	R/WO
2Eh–2Fh	SID	Subsystem Identification	0000h	R/WO
34h	CAP	Capabilities Pointer	80h	RO
3Ch	INT_LN	Interrupt Line	00h	R/W
3Dh	INT_PN	Interrupt Pin	See register description	RO
40h–41h	IDE_TIM	Primary IDE Timing Register	0000h	R/W



Table 14-1. SATA Controller PCI Register Address Map (SATA-D31:F2) (Sheet 2 of 2)

Offset	Mnemonic	Register Name	Default	Attribute
42h-43h	IDE_TIM	Secondary IDE Timing Register	0000h	R/W
70h-71h	PID	PCI Power Management Capability ID	See register description	RO
72h-73h	PC	PCI Power Management Capabilities	See register description	RO
74h-75h	PMCS	PCI Power Management Control and Status	See register description	R/W, RO, R/WC
80h-81h	MSICI	Message Signaled Interrupt Capability ID	7005h	RO
82h-83h	MSIMC	Message Signaled Interrupt Message Control	0000h	RO, R/W
84h-87h	MSIMA	Message Signaled Interrupt Message Address	00000000h	RO, R/W
88h-89h	MSIMD	Message Signaled Interrupt Message Data	0000h	R/W
90h	MAP	Address Map	0000h	R/W, R/WO
92h-93h	PCS	Port Control and Status	0000h	R/W, RO
94h-97h	SCLKCG	SATA Clock Gating Control	00000000h	R/W
9Ch-9Fh	SCLKGC	SATA Clock General Configuration	00000000h	R/W, R/WO
A8h-ABh	SATACR0	SATA Capability Register 0	0010B012h	RO, R/WO
ACh-AFh	SATACR1	SATA Capability Register 1	00000048h	RO
B0h-B1h	FLRCID	FLR Capability ID	0009h	RO
B2h-B3h	FLRCLV	FLR Capability Length and Version	See register description	R/WO, RO
B4h-B5h	FLRC	FLR Control	0000h	RO, R/W
C0h	ATC	APM Trapping Control	00h	R/W
C4h	ATS	ATM Trapping Status	00h	R/WC
D0h-D3h	SP	Scratch Pad	00000000h	R/W
E0h-E3h	BFCS	BIST FIS Control/Status	00000000h	R/W, R/WC
E4h-E7h	BFTD1	BIST FIS Transmit Data, DW1	00000000h	R/W
E8h-EBh	BFTD2	BIST FIS Transmit Data, DW2	00000000h	R/W

NOTE: The PCH SATA controller is not arbitrated as a PCI device; therefore, it does not need a master latency timer.

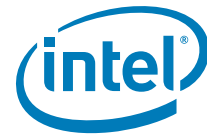

14.1.1 VID—Vendor Identification Register (SATA—D31:F2)

Offset Address: 00h–01h Attribute: RO
 Default Value: 8086h Size: 16 bit
 Lockable: No Power Well: Core

Bit	Description
15:0	Vendor ID — RO. This is a 16-bit value assigned to Intel. Intel VID = 8086h

14.1.2 DID—Device Identification Register (SATA—D31:F2)

Offset Address: 02h–03h Attribute: RO
 Default Value: See bit description Size: 16 bit
 Lockable: No Power Well: Core

Bit	Description
15:0	Device ID — RO. This is a 16-bit value assigned to the PCH SATA controller. NOTE: The value of this field will change dependent upon the value of the MAP Register. See Section 14.1.30

14.1.3 PCICMD—PCI Command Register (SATA—D31:F2)

Address Offset: 04h–05h Attribute: RO, R/W
 Default Value: 0000h Size: 16 bits

Bit	Description
15:11	Reserved
10	Interrupt Disable — R/W. This disables pin-based INTx# interrupts. This bit has no effect on MSI operation. 0 = Internal INTx# messages are generated if there is an interrupt and MSI is not enabled. 1 = Internal INTx# messages will not be generated.
9	Fast Back to Back Enable (FBE) — RO. Hardwired to 0.
8	SERR# Enable (SERR_EN) — RO. Hardwired to 0.
7	Wait Cycle Control (WCC) — RO. Hardwired to 0.
6	Parity Error Response (PER) — R/W. 0 = Disabled. SATA controller will not generate PERR# when a data parity error is detected. 1 = Enabled. SATA controller will generate PERR# when a data parity error is detected.
5	VGA Palette Snoop (VPS) — RO. Hardwired to 0.
4	Postable Memory Write Enable (PMWE) — RO. Hardwired to 0.
3	Special Cycle Enable (SCE) — RO. Hardwired to 0.
2	Bus Master Enable (BME) — R/W. This bit controls the SATA controller's ability to act as a master for data transfers. This bit does not impact the generation of completions for split transaction commands.
1	Memory Space Enable (MSE) — R/W / RO. Controls access to the SATA controller's target memory space (for AHCI). This bit is RO 0 when not in AHCI/RAID modes.
0	I/O Space Enable (IOSE) — R/W. This bit controls access to the I/O space registers. 0 = Disables access to the Legacy or Native IDE ports (both Primary and Secondary) as well as the Bus Master I/O registers. 1 = Enable. Note that the Base Address register for the Bus Master registers should be programmed before this bit is set.



14.1.4 PCISTS — PCI Status Register (SATA–D31:F2)

Address Offset: 06h–07h Attribute: R/WC, RO
Default Value: 02B0h Size: 16 bits

Note: For the writable bits, software must write a 1 to clear bits that are set. Writing a 0 to the bit has no effect.

Bit	Description
15	Detected Parity Error (DPE) — R/WC. 0 = No parity error detected by SATA controller. 1 = SATA controller detects a parity error on its interface.
14	Signaled System Error (SSE) — RO. Hardwired to 0.
13	Received Master Abort (RMA) — R/WC. 0 = Master abort not generated. 1 = SATA controller, as a master, generated a master abort.
12	Reserved — R/WC.
11	Signaled Target Abort (STA) — RO. Hardwired to 0.
10:9	DEVSEL# Timing Status (DEV_STS) — RO. 01 = Hardwired; Controls the device select time for the SATA controller's PCI interface.
8	Data Parity Error Detected (DPED) — R/WC. For PCH, this bit can only be set on read completions received from the bus when there is a parity error. 0 = No data parity error received. 1 = SATA controller, as a master, either detects a parity error or sees the parity error line asserted, and the parity error response bit (bit 6 of the command register) is set.
7	Fast Back to Back Capable (FB2BC) — RO. Hardwired to 1.
6	Reserved
5	66MHz Capable (66MHZ_CAP) — RO. Hardwired to 1.
4	Capabilities List (CAP_LIST) — RO. This bit indicates the presence of a capabilities list. The minimum requirement for the capabilities list must be PCI power management for the SATA controller.
3	Interrupt Status (INTS) — RO. Reflects the state of INTx# messages, IRQ14 or IRQ15. 0 = Interrupt is cleared (independent of the state of Interrupt Disable bit in the command register [offset 04h]). 1 = Interrupt is to be asserted
2:0	Reserved

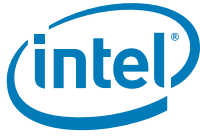
**14.1.6.3 When Sub Class Code Register (D31:F2:Offset 0Ah) = 06h**

Address Offset: 09h
 Default Value: 01h

Attribute: RO
 Size: 8 bits

Bit	Description
7:0	Interface (IF) — RO. Indicates that the SATA Controller is an AHCI HBA that has a major revision of 1.

14.1.7 SCC—Sub Class Code Register (SATA–D31:F2)

Address Offset: 0Ah
 Default Value: See bit description

Attribute: RO
 Size: 8 bits

Bit	Description								
7:0	<p>Sub Class Code (SCC) This field specifies the sub-class code of the controller, per the table below:</p> <table border="1"> <thead> <tr> <th>MAP.SMS (D31:F2:Offset 90h:bit 7:6) Value</th> <th>SCC Register Value</th> </tr> </thead> <tbody> <tr> <td>00b</td> <td>01h (IDE Controller)</td> </tr> <tr> <td>01b</td> <td>06h (AHCI Controller)</td> </tr> <tr> <td>10b</td> <td>04h (RAID Controller)</td> </tr> </tbody> </table> <p>NOTE: Not all SCC values may be available for a given SKU. See Section 1.3 for details on storage controller capabilities.</p>	MAP.SMS (D31:F2:Offset 90h:bit 7:6) Value	SCC Register Value	00b	01h (IDE Controller)	01b	06h (AHCI Controller)	10b	04h (RAID Controller)
MAP.SMS (D31:F2:Offset 90h:bit 7:6) Value	SCC Register Value								
00b	01h (IDE Controller)								
01b	06h (AHCI Controller)								
10b	04h (RAID Controller)								

14.1.8 BCC—Base Class Code Register (SATA–D31:F2SATA–D31:F2)

Address Offset: 0Bh
 Default Value: 01h

Attribute: RO
 Size: 8 bits

Bit	Description
7:0	Base Class Code (BCC) — RO. 01h = Mass storage device



14.1.12 PCNL_BAR—Primary Control Block Base Address Register (SATA-D31:F2)

Address Offset: 14h-17h Attribute: R/W, RO
Default Value: 00000001h Size: 32 bits

Bit	Description
31:16	Reserved
15:2	Base Address — R/W. This field provides the base address of the I/O space (4 consecutive I/O locations).
1	Reserved
0	Resource Type Indicator (RTE) — RO. Hardwired to 1 to indicate a request for I/O space.

NOTE: This 4-byte I/O space is used in native mode for the Primary Controller's Control Block.

14.1.13 SCMD_BAR—Secondary Command Block Base Address Register (SATA D31:F2)

Address Offset: 18h-1Bh Attribute: R/W, RO
Default Value: 00000001h Size: 32 bits

Bit	Description
31:16	Reserved
15:3	Base Address — R/W. This field provides the base address of the I/O space (8 consecutive I/O locations).
2:1	Reserved
0	Resource Type Indicator (RTE) — RO. Hardwired to 1 to indicate a request for I/O space.

NOTE: This 8-byte I/O space is used in native mode for the Secondary Controller's Command Block.

14.1.14 SCNL_BAR—Secondary Control Block Base Address Register (SATA D31:F2)

Address Offset: 1Ch-1Fh Attribute: R/W, RO
Default Value: 00000001h Size: 32 bits

Bit	Description
31:16	Reserved
15:2	Base Address — R/W. This field provides the base address of the I/O space (4 consecutive I/O locations).
1	Reserved
0	Resource Type Indicator (RTE) — RO. Hardwired to 1 to indicate a request for I/O space.

NOTE: This 4-byte I/O space is used in native mode for the Secondary Controller's Control Block.



14.1.15 BAR—Legacy Bus Master Base Address Register (SATA–D31:F2)

Address Offset: 20h–23h Attribute: R/W, RO
 Default Value: 00000001h Size: 32 bits

The Bus Master IDE interface function uses Base Address register 5 to request a 16-byte I/O space to provide a software interface to the Bus Master functions. Only 12 bytes are actually used (6 bytes for primary, 6 bytes for secondary). Only bits [15:4] are used to decode the address.

Bit	Description
31:16	Reserved
15:5	Base Address — R/W. This field provides the base address of the I/O space (16 consecutive I/O locations).
4	Base — R/W / RO. When SCC is 01h, this bit will be R/W resulting in requesting 16B of I/O space. When SCC is not 01h, this bit will be Read Only 0, resulting in requesting 32B of I/O space.
3:1	Reserved
0	Resource Type Indicator (RTE) — RO. Hardwired to 1 to indicate a request for I/O space.

14.1.16 ABAR/SIDPBA1—AHCI Base Address Register/Serial ATA Index Data Pair Base Address (SATA–D31:F2)

When the programming interface is not IDE (that is, SCC is not 01h), this register is named ABAR. When the programming interface is IDE, this register becomes SIDPBA.

Note that hardware does not clear those BA bits when switching from IDE component to non-IDE component or vice versa. BIOS is responsible for clearing those bits to 0 since the number of writable bits changes after component switching (as indicated by a change in SCC). In the case, this register will then have to be re-programmed to a proper value.

14.1.16.1 When SCC is not 01h

When the programming interface is not IDE, the register represents a memory BAR allocating space for the AHCI memory registers defined in [Section 14.4](#).

Address Offset: 24–27h Attribute: R/W, RO
 Default Value: 00000000h Size: 32 bits

Bit	Description
31:11	Base Address (BA) — R/W. Base address of register memory space (aligned to 2 KB)
10:4	Reserved
3	Prefetchable (PF) — RO. Indicates that this range is not pre-fetchable
2:1	Type (TP) — RO. Indicates that this range can be mapped anywhere in 32-bit address space.
0	Resource Type Indicator (RTE) — RO. Hardwired to 0 to indicate a request for register memory space.

NOTE:

- The ABAR register must be set to a value of 0001_0000h or greater.



14.1.16.2 When SCC is 01h

When the programming interface is IDE, the register becomes an I/O BAR allocating 16 bytes of I/O space for the I/O-mapped registers defined in Section 14.2. Note that although 16 bytes of locations are allocated, only 8 bytes are used as SINDX and SDATA registers; with the remaining 8 bytes preserved for future enhancement.

Address Offset: 24h-27h Attribute: R/WO
 Default Value: 00000001h Size: 32 bits

Bit	Description
31:16	Reserved
15:4	Base Address (BA) — R/W. Base address of the I/O space.
3:1	Reserved
0	Resource Type Indicator (RTE) — RO. Indicates a request for I/O space.

14.1.17 SVID—Subsystem Vendor Identification Register (SATA-D31:F2)

Address Offset: 2Ch-2Dh Attribute: R/WO
 Default Value: 0000h Size: 16 bits
 Lockable: No Power Well: Core
 Function Level Reset: No

Bit	Description
15:0	Subsystem Vendor ID (SVID) — R/WO. Value is written by BIOS. No hardware action taken on this value.

14.1.18 SID—Subsystem Identification Register (SATA-D31:F2)

Address Offset: 2Eh-2Fh Attribute: R/WO
 Default Value: 0000h Size: 16 bits
 Lockable: No Power Well: Core
 Function Level Reset: No

Bit	Description
15:0	Subsystem ID (SID) — R/WO. Value is written by BIOS. No hardware action taken on this value.

14.1.19 CAP—Capabilities Pointer Register (SATA-D31:F2)

Address Offset: 34h Attribute: RO
 Default Value: 80h Size: 8 bits

Bit	Description
7:0	Capabilities Pointer (CAP_PTR) — RO. Indicates that the first capability pointer offset is 80h. This value changes to 70h if the Sub Class Code (SCC) (Dev 31:F2:0Ah) is configure as IDE mode (value of 01).



14.1.20 INT_LN—Interrupt Line Register (SATA–D31:F2)

Address Offset: 3Ch Attribute: R/W
 Default Value: 00h Size: 8 bits
 Function Level Reset: No

Bit	Description
7:0	Interrupt Line — R/W. This field is used to communicate to software the interrupt line that the interrupt pin is connected to. Interrupt Line register is not reset by FLR.

14.1.21 INT_PN—Interrupt Pin Register (SATA–D31:F2)

Address Offset: 3Dh Attribute: RO
 Default Value: See Register Description Size: 8 bits

Bit	Description
7:0	Interrupt Pin — RO. This reflects the value of D31IP.SIP (Chipset Config Registers:Offset 3100h:bits 11:8).

14.1.22 IDE_TIM—IDE Timing Register (SATA–D31:F2)

Address Offset: Primary: 40h–41h Attribute: R/W
 Secondary: 42h–43h
 Default Value: 0000h Size: 16 bits

Bit	Description
15	IDE Decode Enable (IDE) — R/W. Individually enable/disable the Primary or Secondary decode. 0 = Disable. 1 = Enables the PCH to decode the associated Command Blocks (1F0–1F7h for primary, 170–177h for secondary, or their native mode BAR equivalents) and Control Block (3F6h for primary, 376h for secondary, or their native mode BAR equivalents). This bit effects the IDE decode ranges for both legacy and native-mode decoding.
14:0	Reserved

14.1.23 PID—PCI Power Management Capability Identification Register (SATA–D31:F2)

Address Offset: 70h–71h Attribute: RO
 Default Value: See Register Description Size: 16 bits

Bits	Description
15:8	Next Capability (NEXT) — RO. B0h — if SCC = 01h (IDE mode) indicating next item is FLR capability pointer. A8h — for all other values of SCC to point to the next capability structure.
7:0	Capability ID (CID) — RO. Hardwired to 01h. Indicates that this pointer is a PCI power management.



14.1.24 PC–PCI Power Management Capabilities Register (SATA–D31:F2)

Address Offset: 72h–73h Attribute: RO
Default Value: See Register Description Size: 16 bits

Bits	Description
15:11	PME Support (PME_SUP) — RO. 00000 = If SCC = 01h, indicates no PME support in IDE mode. 01000 = If SCC is not 01h, in a non-IDE mode, indicates PME# can be generated from the D3 _{HOT} state in the SATA host controller.
10	D2 Support (D2_SUP) — RO. Hardwired to 0. The D2 state is not supported
9	D1 Support (D1_SUP) — RO. Hardwired to 0. The D1 state is not supported
8:6	Auxiliary Current (AUX_CUR) — RO. PME# from D3 _{COLD} state is not supported, therefore this field is 000b.
5	Device Specific Initialization (DSI) — RO. Hardwired to 0 to indicate that no device-specific initialization is required.
4	Reserved
3	PME Clock (PME_CLK) — RO. Hardwired to 0 to indicate that PCI clock is not required to generate PME#.
2:0	Version (VER) — RO. Hardwired to 011 to indicates support for Revision 1.2 of the PCI Power Management Specification.



14.1.25 PMCS—PCI Power Management Control and Status Register (SATA–D31:F2)

Address Offset: 74h–75h Attribute: R/W, R/WC
 Default Value: 0008h Size: 16 bits
 Function Level Reset: No (Bits 8 and 15)

Bits	Description
15	<p>PME Status (PMES) — R/WC. Bit is set when a PME event is to be requested, and if this bit and PMEE is set, a PME# will be generated from the SATA controller</p> <p>NOTE: Whenever SCC = 01h, hardware will automatically change the attribute of this bit to RO 0. Software is advised to clear PMEE and PMES together prior to changing SCC thru MAP.SMS.</p> <p>This bit is not reset by Function Level Reset.</p>
14:9	Reserved
8	<p>PME Enable (PMEE) — R/W. When set, the SATA controller generates PME# form D3_{HOT} on a wake event.</p> <p>NOTE: Whenever SCCSCC = 01h, hardware will automatically change the attribute of this bit to RO 0. Software is advised to clear PMEE and PMES together prior to changing SCC thru MAP.SMS.</p> <p>This bit is not reset by Function Level Reset.</p>
7:4	Reserved
3	<p>No Soft Reset (NSFRST) — RO. These bits are used to indicate whether devices transitioning from D3_{HOT} state to D0 state will perform an internal reset.</p> <p>0 = Device transitioning from D3_{HOT} state to D0 state perform an internal reset. 1 = Device transitioning from D3_{HOT} state to D0 state do not perform an internal reset.</p> <p>Configuration content is preserved. Upon transition from the D3_{HOT} state to D0 state initialized state, no additional operating system intervention is required to preserve configuration context beyond writing to the PowerState bits.</p> <p>Regardless of this bit, the controller transition from D3_{HOT} state to D0 state by a system or bus segment reset will return to the state D0 uninitialized with only PME context preserved if PME is supported and enabled.</p>
2	Reserved
1:0	<p>Power State (PS) — R/W. These bits are used both to determine the current power state of the SATA controller and to set a new power state.</p> <p>00 = D0 state 11 = D3_{HOT} state</p> <p>When in the D3_{HOT} state, the controller's configuration space is available, but the I/O and memory spaces are not. Additionally, interrupts are blocked.</p>



14.1.26 MSICI—Message Signaled Interrupt Capability Identification Register (SATA-D31:F2)

Address Offset: 80h-81h Attribute: RO
Default Value: 7005h Size: 16 bits

Note: There is no support for MSI when the software is operating in legacy (IDE) mode when AHCI is not enabled. Prior to switching from AHCI to IDE mode, software **must** make sure that MSI is disabled.

Bits	Description
15:8	Next Pointer (NEXT) — RO. Indicates the next item in the list is the PCI power management pointer.
7:0	Capability ID (CID) — RO. Capabilities ID indicates MSI.

14.1.27 MSIMC—Message Signaled Interrupt Message Control Register (SATA-D31:F2)

Address Offset: 82h-83h Attribute: R/W, RO
Default Value: 0000h Size: 16 bits

Note: There is no support for MSI when the software is operating in legacy (IDE) mode when AHCI is not enabled. Prior to switching from AHCI to IDE mode, software **must** make sure that MSI is disabled.

Bits	Description
15:8	Reserved
7	64 Bit Address Capable (C64) — RO. Capable of generating a 32-bit message only.



Bits	Description																																						
6:4	<p>Multiple Message Enable (MME) — RO. = 000 (and MSIE is set), a single MSI message will be generated for all SATA ports, and bits [15:0] of the message vector will be driven from MD[15:0]. For 6 port components:</p> <table border="1" data-bbox="522 464 1357 781"> <thead> <tr> <th rowspan="2">MME</th> <th colspan="4">Value Driven on MSI Memory Write</th> </tr> <tr> <th>Bits[15:3]</th> <th>Bit[2]</th> <th>Bit[1]</th> <th>Bit[0]</th> </tr> </thead> <tbody> <tr> <td>000, 001, 010</td> <td>MD[15:3]</td> <td>MD[2]</td> <td>MD[1]</td> <td>MD[0]</td> </tr> <tr> <td>011</td> <td>MD[15:3]</td> <td>Port 0: 0 Port 1: 0 Port 2: 0 Port 3: 0 Port 4: 1 Port 5: 1</td> <td>Port 0: 0 Port 1: 0 Port 2: 1 Port 3: 1 Port 4: 0 Port 5: 0</td> <td>Port 0: 0 Port 1: 1 Port 2: 0 Port 3: 1 Port 4: 0 Port 5: 1</td> </tr> </tbody> </table> <p>For 4 port components:</p> <table border="1" data-bbox="522 877 1362 1142"> <thead> <tr> <th rowspan="2">MME</th> <th colspan="4">Value Driven on MSI Memory Write</th> </tr> <tr> <th>Bits[15:3]</th> <th>Bit[2]</th> <th>Bit[1]</th> <th>Bit[0]</th> </tr> </thead> <tbody> <tr> <td>000, 001, 010</td> <td>MD[15:3]</td> <td>MD[2]</td> <td>MD[1]</td> <td>MD[0]</td> </tr> <tr> <td>011</td> <td>MD[15:3]</td> <td>Port 0: 0 Port 1: 0 Port 4: 1 Port 5: 1</td> <td>Port 0: 0 Port 1: 0 Port 2: 0 Port 3: 0</td> <td>Port 0: 0 Port 1: 1 Port 2: 0 Port 3: 1</td> </tr> </tbody> </table> <p>All other MME values are reserved. If this field is set to one of these reserved values, the results are undefined. NOTE: The CCC interrupt is generated on unimplemented port (AHCI PI register bit equal to 0). If CCC interrupt is disabled, no MSI shall be generated for the port dedicated to the CCC interrupt. When CCC interrupt occurs, MD[2:0] is dependant on CCC_CTL.INT (in addition to MME).</p>	MME	Value Driven on MSI Memory Write				Bits[15:3]	Bit[2]	Bit[1]	Bit[0]	000, 001, 010	MD[15:3]	MD[2]	MD[1]	MD[0]	011	MD[15:3]	Port 0: 0 Port 1: 0 Port 2: 0 Port 3: 0 Port 4: 1 Port 5: 1	Port 0: 0 Port 1: 0 Port 2: 1 Port 3: 1 Port 4: 0 Port 5: 0	Port 0: 0 Port 1: 1 Port 2: 0 Port 3: 1 Port 4: 0 Port 5: 1	MME	Value Driven on MSI Memory Write				Bits[15:3]	Bit[2]	Bit[1]	Bit[0]	000, 001, 010	MD[15:3]	MD[2]	MD[1]	MD[0]	011	MD[15:3]	Port 0: 0 Port 1: 0 Port 4: 1 Port 5: 1	Port 0: 0 Port 1: 0 Port 2: 0 Port 3: 0	Port 0: 0 Port 1: 1 Port 2: 0 Port 3: 1
MME	Value Driven on MSI Memory Write																																						
	Bits[15:3]	Bit[2]	Bit[1]	Bit[0]																																			
000, 001, 010	MD[15:3]	MD[2]	MD[1]	MD[0]																																			
011	MD[15:3]	Port 0: 0 Port 1: 0 Port 2: 0 Port 3: 0 Port 4: 1 Port 5: 1	Port 0: 0 Port 1: 0 Port 2: 1 Port 3: 1 Port 4: 0 Port 5: 0	Port 0: 0 Port 1: 1 Port 2: 0 Port 3: 1 Port 4: 0 Port 5: 1																																			
MME	Value Driven on MSI Memory Write																																						
	Bits[15:3]	Bit[2]	Bit[1]	Bit[0]																																			
000, 001, 010	MD[15:3]	MD[2]	MD[1]	MD[0]																																			
011	MD[15:3]	Port 0: 0 Port 1: 0 Port 4: 1 Port 5: 1	Port 0: 0 Port 1: 0 Port 2: 0 Port 3: 0	Port 0: 0 Port 1: 1 Port 2: 0 Port 3: 1																																			
3:1	Multiple Message Capable (MMC) — RO. MMC is not supported.																																						
0	<p>MSI Enable (MSIE) — R/W /RO. If set, MSI is enabled and traditional interrupt pins are not used to generate interrupts. This bit is R/W when SC.SCC is not 01h and is read-only 0 when SCC is 01h. Note that CMD.ID bit has no effect on MSI.</p> <p>NOTE: Software must clear this bit to 0 to disable MSI first before changing the number of messages allocated in the MMC field. Software must also make sure this bit is cleared to '0' when operating in legacy mode (when GHC.AE = 0).</p>																																						



14.1.28 MSIMA— Message Signaled Interrupt Message Address Register (SATA–D31:F2)

Address Offset: 84h–87h Attribute: R/W
Default Value: 00000000h Size: 32 bits

Note: There is no support for MSI when the software is operating in legacy (IDE) mode when AHCI is not enabled. Prior to switching from AHCI to IDE mode, software **must** make sure that MSI is disabled.

Bits	Description
31:2	Address (ADDR) — R/W. Lower 32 bits of the system specified message address, always DWORD aligned.
1:0	Reserved

14.1.29 MSIMD—Message Signaled Interrupt Message Data Register (SATA–D31:F2)

Address Offset: 88h–89h Attribute: R/W
Default Value: 0000h Size: 16 bits

Note: There is no support for MSI when the software is operating in legacy (IDE) mode when AHCI is not enabled. Prior to switching from AHCI to IDE mode, software **must** make sure that MSI is disabled.

Bits	Description
15:0	Data (DATA) — R/W. This 16-bit field is programmed by system software if MSI is enabled. Its content is driven onto the lower word of the data bus of the MSI memory write transaction. Note that when the MME field is set to '001' or '010', bit [0] and bits [1:0] respectively of the MSI memory write transaction will be driven based on the source of the interrupt rather than from MD[2:0]. See the description of the MME field.



14.1.30 MAP—Address Map Register (SATA–D31:F2)

Address Offset: 90h Attribute: R/W, R/WO
 Default Value: 0000h Size: 16 bits
 Function Level Reset: No (Bits 7:5 and 13:8 only)

Bits	Description
15:8	Reserved
7:6	<p>SATA Mode Select (SMS) — R/W. Software programs these bits to control the mode in which the SATA Controller should operate:</p> <p>00b = IDE mode 01b = AHCI mode 10b = RAID mode 11b = Reserved</p> <p>NOTES:</p> <ol style="list-style-type: none"> The SATA Function Device ID will change based on the value of this register. When switching from AHCI or RAID mode to IDE mode, a 2 port SATA controller (Device 31, Function 5) will be enabled. SW shall not manipulate SMS during runtime operation; that is, the OS will not do this. The BIOS may choose to switch from one mode to another during POST. Not all register values may be available for a given SKU. See Section 1.3 for details on storage controller capabilities. <p>These bits are not reset by Function Level Reset.</p>
5	<p>SATA Port-to-Controller Configuration (SC) — R/W. This bit changes the number of SATA ports available within each SATA Controller.</p> <p>0 = Up to 4 SATA ports are available for Controller 1 (Device 31 Function 2) with ports [3:0] and up to 2 SATA ports are available for Controller 2 (Device 31 Function 5) with ports [5:4].</p> <p>1 = Up to 6 SATA ports are available for Controller 1 (Device 31 Function 2) with ports [5:0] and no SATA ports are available for Controller 2 (Device 31 Function 5).</p> <p>NOTE: This bit should be set to 1 in AHCI/RAID mode. This bit is not reset by Function Level Reset.</p>
4:0	Reserved



14.1.31 PCS—Port Control and Status Register (SATA–D31:F2)

Address Offset: 92h–93h Attribute: R/W, RO
 Default Value: 0000h Size: 16 bits
 Function Level Reset: No

By default, the SATA ports are set to the disabled state (bits [5:0] = 0). When enabled by software, the ports can transition between the on, partial, and slumber states and can detect devices. When disabled, the port is in the “off” state and cannot detect any devices.

If an AHCI-aware or RAID enabled operating system is being booted, then system BIOS shall insure that all supported SATA ports are enabled prior to passing control to the OS. Once the AHCI aware OS is booted, it becomes the enabling/disabling policy owner for the individual SATA ports. This is accomplished by manipulating a port’s PxSCTL and PxCMD fields. Because an AHCI or RAID aware OS will typically not have knowledge of the PxE bits and because the PxE bits act as master on/off switches for the ports, pre-boot software must insure that these bits are set to 1 prior to booting the OS, regardless as to whether or not a device is currently on the port.

Bits	Description
15	OOB Retry Mode (ORM) — R/W. 0 = The SATA controller will not retry after an OOB failure 1 = The SATA controller will continue to retry after an OOB failure until successful (infinite retry)
14	Reserved
13	Port 5 Present (P5P) — RO. The status of this bit may change at any time. This bit is cleared when the port is disabled using P5E. This bit is not cleared upon surprise removal of a device. 0 = No device detected. 1 = The presence of a device on Port 5 has been detected.
12	Port 4 Present (P4P) — RO. The status of this bit may change at any time. This bit is cleared when the port is disabled using P4E. This bit is not cleared upon surprise removal of a device. 0 = No device detected. 1 = The presence of a device on Port 4 has been detected.
11	Port 3 Present (P3P) — RO. The status of this bit may change at any time. This bit is cleared when the port is disabled using P3E. This bit is not cleared upon surprise removal of a device. 0 = No device detected. 1 = The presence of a device on Port 3 has been detected. NOTE: Bit may be Reserved depending on if port is available in the given SKU. See Section 1.3 for details if port is available.
10	Port 2 Present (P2P) — RO. The status of this bit may change at any time. This bit is cleared when the port is disabled using P2E. This bit is not cleared upon surprise removal of a device. 0 = No device detected. 1 = The presence of a device on Port 2 has been detected. NOTE: Bit may be Reserved depending on if port is available in the given SKU. See Section 1.3 for details if port is available.
9	Port 1 Present (P1P) — RO. The status of this bit may change at any time. This bit is cleared when the port is disabled using P1E. This bit is not cleared upon surprise removal of a device. 0 = No device detected. 1 = The presence of a device on Port 1 has been detected.



Bits	Description
8	<p>Port 0 Present (POP) — RO. The status of this bit may change at any time. This bit is cleared when the port is disabled using P0E. This bit is not cleared upon surprise removal of a device.</p> <p>0 = No device detected. 1 = The presence of a device on Port 0 has been detected.</p>
7:6	Reserved
5	<p>Port 5 Enabled (P5E) — R/W / RO.</p> <p>0 = Disabled. The port is in the 'off' state and cannot detect any devices. 1 = Enabled. The port can transition between the on, partial, and slumber states and can detect devices.</p> <p>NOTE:</p> <ol style="list-style-type: none"> This bit takes precedence over P5CMD.SUD (offset ABAR+398h:bit 1) If MAP.SC is 0, SCC is 01h, or MAP.SPD[5] is 1h, then this bit will be read only 0.
4	<p>Port 4 Enabled (P4E) — R/W / RO.</p> <p>0 = Disabled. The port is in the 'off' state and cannot detect any devices. 1 = Enabled. The port can transition between the on, partial, and slumber states and can detect devices.</p> <p>NOTE:</p> <ol style="list-style-type: none"> This bit takes precedence over P4CMD.SUD (offset ABAR+318h:bit 1) If MAP.SC is 0, SCC is 01h, or MAP.SPD[4] is 1h, then this bit will be read only 0.
3	<p>Port 3 Enabled (P3E) — R/W / RO.</p> <p>0 = Disabled. The port is in the 'off' state and cannot detect any devices. 1 = Enabled. The port can transition between the on, partial, and slumber states and can detect devices.</p> <p>NOTE:</p> <ol style="list-style-type: none"> This bit takes precedence over P3CMD.SUD (offset ABAR+298h:bit 1). When MAP.SPD[3] is 1 this is reserved and is read-only 0. Bit may be Reserved and RO depending on if port is available in the given SKU. See Section 1.3 for details if port is available.
2	<p>Port 2 Enabled (P2E) — R/W / RO.</p> <p>0 = Disabled. The port is in the 'off' state and cannot detect any devices. 1 = Enabled. The port can transition between the on, partial, and slumber states and can detect devices.</p> <p>NOTE:</p> <ol style="list-style-type: none"> This bit takes precedence over P2CMD.SUD (offset ABAR+218h:bit 1). When MAP.SPD[2] is 1 this is reserved and is read-only 0. Bit may be Reserved and RO depending on if port is available in the given SKU. See Section 1.3 for details if port is available.
1	<p>Port 1 Enabled (P1E) — R/W / RO.</p> <p>0 = Disabled. The port is in the 'off' state and cannot detect any devices. 1 = Enabled. The port can transition between the on, partial, and slumber states and can detect devices.</p> <p>NOTE: This bit takes precedence over P1CMD.SUD (offset ABAR+198h:bit 1). When MAP.SPD[1] is 1 this is reserved and is read-only 0.</p>
0	<p>Port 0 Enabled (P0E) — R/W / RO.</p> <p>0 = Disabled. The port is in the 'off' state and cannot detect any devices. 1 = Enabled. The port can transition between the on, partial, and slumber states and can detect devices.</p> <p>NOTE: This bit takes precedence over P0CMD.SUD (offset ABAR+118h:bit 1). When MAP.SPD[0] is 1 this is reserved and is read-only 0.</p>



14.1.32 SCLKCG—SATA Clock Gating Control Register

Address Offset: 94h–97h Attribute: R/W
 Default Value: 00000000h Size: 32 bits

Bit	Description
31:30	Reserved
29:24	<p>Port Clock Disable (PCD) — R/W.</p> <p>0 = All clocks to the associated port logic will operate normally. 1 = The backbone clock driven to the associated port logic is gated and will not toggle.</p> <p>Bit 29: Port 5 Bit 28: Port 4 Bit 27: Port 3 Bit 26: Port 2 Bit 25: Port 1 Bit 24: Port 0</p> <p>If a port is not available, software shall set the corresponding bit to 1. Software can also set the corresponding bits to 1 on ports that are disabled. Software cannot set the PCD [port x]=1 if the corresponding PCS.PxE=1 in either Dev31Func2 or Dev31Func5 (dual controller IDE mode) or AHCI GHC.PI[x] = "1".</p>
23:9	Reserved
8:0	SCLKCG Field 1 — R/W. BIOS must program these bits to 183h.

14.1.33 SCLKGC—SATA Clock General Configuration Register

Address Offset: 9Ch–9Fh Attribute: R/W, R/WO
 Default Value: 00000000h Size: 32 bits
 Function Level Reset: No

Bit	Description
31:8	Reserved
7 (non-RAID Capable SKUs Only)	Reserved
7 (RAID Capable SKUs Only)	<p>Alternate ID Enable (AIE) — R/WO.</p> <p>0 = When in RAID mode the SATA Controller located at Device 31: Function 2 will report the Device ID 2822h for Desktop or 282Ah for Mobile and the Microsoft Windows Vista* and Windows* 7 in-box version of the Intel® Rapid Storage Manager will load on the platform. 1 = When in RAID mode the SATA Controller located at Device 31: Function 2 will report the Device ID 1C04h for Desktop RAID 0/1/5/10 without Intel® Smart Response Technology, 1C06h for Desktop RAID 0/1/5/10 with Intel Smart Response Technology, or 1C05h for Mobile to prevent the Microsoft Windows Vista or Windows 7 in-box version of the Intel® Rapid Storage Manager from loading on the platform and will require the user to perform an 'F6' installation of the appropriate Intel® Rapid Storage Manager.</p> <p>NOTE: This field is applicable when the AHCI is configured for RAID mode of operation. It has no impact for AHCI and IDE modes of operation. BIOS is recommended to program this bit prior to programming the MAP.SMS field to reflect RAID. This field is reset by PLTRST#. BIOS is required to reprogram the value of this bit after resuming from S3, S4, and S5.</p>
6:1	Reserved



Bit	Description
0	<p>SATA 4-port All Master Configuration Indicator (SATA4PMIND) — RO.</p> <p>0 = Normal configuration. 1 = Two IDE Controllers are implemented, each supporting two ports for a Primary Master and a Secondary Master.</p> <p>NOTE: BIOS must also make sure that corresponding port clocks are gated (using SCLKCG configuration register).</p>

14.1.34 SATACR0—SATA Capability Register 0 (SATA–D31:F2)

Address Offset:	A8h–ABh	Attribute:	RO, R/WO
Default Value:	0010B012h	Size:	32 bits
Function Level Reset:	No (Bits 15:8 only)		

Note: This register is read-only 0 when SCC is 01h.

Bit	Description
31:24	Reserved
23:20	Major Revision (MAJREV) — RO. Major revision number of the SATA Capability Pointer implemented.
19:16	Minor Revision (MINREV) — RO. Minor revision number of the SATA Capability Pointer implemented.
15:8	Next Capability Pointer (NEXT) — R/WO. Points to the next capability structure. These bits are not reset by Function Level Reset.
7:0	Capability ID (CAP) — RO. This value of 12h has been assigned by the PCI SIG to designate the SATA Capability Structure.



14.1.37 FLRCLV—FLR Capability Length and Version Register (SATA–D31:F2)

Address Offset: B2–B3h Attribute: RO, R/WO
 Default Value: xx06h Size: 16 bits
 Function Level Reset: No (Bit 9:8 Only when FLRCSSEL = 0)

When FLRCSSEL (RCBA+3410h:bit 12) = 0, this register is defined as follows:

Bit	Description
15:10	Reserved
9	FLR Capability — R/WO. 1 = Support for Function Level reset. This bit is not reset by the Function Level Reset.
8	TXP Capability — R/WO. 1 = Support for Transactions Pending (TXP) bit. TXP must be supported if FLR is supported.
7:0	Vendor-Specific Capability ID — RO. This field indicates the number of bytes of this Vendor Specific capability as required by the PCI specification. It has the value of 06h for the FLR capability.

When FLRCSSEL = 1, this register is defined as follows:

Bit	Description
15:12	Vendor-Specific Capability ID — RO. A value of 2h identifies this capability as the Function Level Reset (FLR).
11:8	Capability Version — RO. This field indicates the version of the FLR capability.
7:0	Vendor-Specific Capability ID — RO. This field indicates the number of bytes of this Vendor Specific capability as required by the PCI specification. It has the value of 06h for the FLR capability.

14.1.38 FLRC—FLR Control Register (SATA–D31:F2)

Address Offset: B4–B5h Attribute: RO, R/W
 Default Value: 0000h Size: 16 bits

Bit	Description
15:9	Reserved
8	Transactions Pending (TXP) — RO. 0 = Controller has received all non-posted requests. 1 = Controller has issued non-posted requests which has not been completed.
7:1	Reserved
0	Initiate FLR — R/W. Used to initiate FLR transition. A write of 1 indicates FLR transition. Since hardware must not respond to any cycles till FLR completion the value read by software from this bit is 0.



14.1.39 ATC—APM Trapping Control Register (SATA–D31:F2)

Address Offset: C0h Attribute: R/W
Default Value: 00h Size: 8 bits
Function Level Reset: No

Bit	Description
7:4	Reserved
3	Secondary Slave Trap (SST) — R/W. Enables trapping and SMI# assertion on legacy I/O accesses to 170h–177h and 376h. The active device on the secondary interface must be device 1 for the trap and/or SMI# to occur.
2	Secondary Master Trap (SPT) — R/W. Enables trapping and SMI# assertion on legacy I/O accesses to 170h–177h and 376h. The active device on the secondary interface must be device 0 for the trap and/or SMI# to occur.
1	Primary Slave Trap (PST) — R/W. Enables trapping and SMI# assertion on legacy I/O accesses to 1F0h–1F7h and 3F6h. The active device on the primary interface must be device 1 for the trap and/or SMI# to occur.
0	Primary Master Trap (PMT) — R/W. Enables trapping and SMI# assertion on legacy I/O accesses to 1F0h–1F7h and 3F6h. The active device on the primary interface must be device 0 for the trap and/or SMI# to occur.

14.1.40 ATS—APM Trapping Status Register (SATA–D31:F2)

Address Offset: C4h Attribute: R/WC
Default Value: 00h Size: 8 bits
Function Level Reset: No

Bit	Description
7:4	Reserved
3	Secondary Slave Trap (SST) — R/WC. Indicates that a trap occurred to the secondary slave device.
2	Secondary Master Trap (SPT) — R/WC. Indicates that a trap occurred to the secondary master device.
1	Primary Slave Trap (PST) — R/WC. Indicates that a trap occurred to the primary slave device.
0	Primary Master Trap (PMT) — R/WC. Indicates that a trap occurred to the primary master device.

14.1.41 SP Scratch Pad Register (SATA–D31:F2)

Address Offset: D0h Attribute: R/W
Default Value: 00000000h Size: 32 bits

Bit	Description
31:0	Data (DT) — R/W. This is a read/write register that is available for software to use. No hardware action is taken on this register.



Bits	Description
11	<p>BIST FIS Successful (BFS) — R/WC. 0 = Software clears this bit by writing a 1 to it. 1 = This bit is set any time a BIST FIS transmitted by PCH receives an R_OK completion status from the device.</p> <p>NOTE: This bit must be cleared by software prior to initiating a BIST FIS.</p>
10	<p>BIST FIS Failed (BFF) — R/WC. 0 = Software clears this bit by writing a 1 to it. 1 = This bit is set any time a BIST FIS transmitted by PCH receives an R_ERR completion status from the device.</p> <p>NOTE: This bit must be cleared by software prior to initiating a BIST FIS.</p>
9	<p>Port 1 BIST FIS Initiate (P1BFI) — R/W. When a rising edge is detected on this bit field, the PCH initiates a BIST FIS to the device on Port 1, using the parameters specified in this register and the data specified in BFTD1 and BFTD2. The BIST FIS will only be initiated if a device on Port 1 is present and ready (not partial/slumber state). After a BIST FIS is successfully completed, software must disable and re-enable the port using the PxE bits at offset 92h prior to attempting additional BIST FISes or to return the PCH to a normal operational mode. If the BIST FIS fails to complete, as indicated by the BFF bit in the register, then software can clear then set the P1BFI bit to initiate another BIST FIS. This can be retried until the BIST FIS eventually completes successfully.</p>
8	<p>Port 0 BIST FIS Initiate (POBFI) — R/W. When a rising edge is detected on this bit field, the PCH initiates a BIST FIS to the device on Port 0, using the parameters specified in this register and the data specified in BFTD1 and BFTD2. The BIST FIS will only be initiated if a device on Port 0 is present and ready (not partial/slumber state). After a BIST FIS is successfully completed, software must disable and re-enable the port using the PxE bits at offset 92h prior to attempting additional BIST FISes or to return the PCH to a normal operational mode. If the BIST FIS fails to complete, as indicated by the BFF bit in the register, then software can clear then set the POBFI bit to initiate another BIST FIS. This can be retried until the BIST FIS eventually completes successfully.</p>
7:2	<p>BIST FIS Parameters (BFP) — R/W. These 6 bits form the contents of the upper 6 bits of the BIST FIS Pattern Definition in any BIST FIS transmitted by the PCH. This field is not port specific — its contents will be used for any BIST FIS initiated on port 0, port 1, port 2, or port 3. The specific bit definitions are:</p> <ul style="list-style-type: none"> Bit 7: T – Far End Transmit mode Bit 6: A – Align Bypass mode Bit 5: S – Bypass Scrambling Bit 4: L – Far End Retimed Loopback Bit 3: F – Far End Analog Loopback Bit 2: P – Primitive bit for use with Transmit mode
1:0	Reserved



14.1.43 BFTD1—BIST FIS Transmit Data1 Register (SATA–D31:F2)

Address Offset: E4h–E7h Attribute: R/W
 Default Value: 00000000h Size: 32 bits

Bits	Description
31:0	BIST FIS Transmit Data 1 — R/W. The data programmed into this register will form the contents of the second DWord of any BIST FIS initiated by the PCH. This register is not port specific—its contents will be used for BIST FIS initiated on any port. Although the 2nd and 3rd DWs of the BIST FIS are only meaningful when the “T” bit of the BIST FIS is set to indicate “Far-End Transmit mode”, this register’s contents will be transmitted as the BIST FIS 2nd DW regardless of whether or not the “T” bit is indicated in the BFCS register (D31:F2:E0h).

14.1.44 BFTD2—BIST FIS Transmit Data2 Register (SATA–D31:F2)

Address Offset: E8h–EBh Attribute: R/W
 Default Value: 00000000h Size: 32 bits

Bits	Description
31:0	BIST FIS Transmit Data 2 — R/W. The data programmed into this register will form the contents of the third DWord of any BIST FIS initiated by the PCH. This register is not port specific—its contents will be used for BIST FIS initiated on any port. Although the 2nd and 3rd DWs of the BIST FIS are only meaningful when the “T” bit of the BIST FIS is set to indicate “Far-End Transmit mode”, this register’s contents will be transmitted as the BIST FIS 3rd DW regardless of whether or not the “T” bit is indicated in the BFCS register (D31:F2:E0h).



14.2 Bus Master IDE I/O Registers (D31:F2)

The bus master IDE function uses 16 bytes of I/O space, allocated using the BAR register, located in Device 31:Function 2 Configuration space, offset 20h. All bus master IDE I/O space registers can be accessed as byte, word, or DWord quantities. Reading reserved bits returns an indeterminate, inconsistent value, and writes to reserved bits have no effect (but should not be attempted). These registers are only used for legacy operation. Software must not use these registers when running AHCI. All I/O registers are reset by Function Level Reset. The register address I/O map is shown in Table 14-2.

Table 14-2. Bus Master IDE I/O Register Address Map

BAR+ Offset	Mnemonic	Register	Default	Attribute
00h	BMICP	Command Register Primary	00h	R/W
01h	—	Reserved	—	RO
02h	BMISP	Bus Master IDE Status Register Primary	00h	R/W, R/WC, RO
03h	—	Reserved	—	RO
04h–07h	BMIDP	Bus Master IDE Descriptor Table Pointer Primary	xxxxxxxxh	R/W
08h	BMICS	Command Register Secondary	00h	R/W
09h	—	Reserved	—	RO
0Ah	BMISS	Bus Master IDE Status Register Secondary	00h	R/W, R/WC, RO
0Bh	—	Reserved	—	RO
0Ch–0Fh	BMIDS	Bus Master IDE Descriptor Table Pointer Secondary	xxxxxxxxh	R/W
10h	AIR	AHCI Index Register	00000000h	R/W, RO
14h	AIDR	AHCI Index Data Register	xxxxxxxxh	R/W



14.2.1 BMIC[P,S]—Bus Master IDE Command Register (D31:F2)

Address Offset: Primary: BAR + 00h Attribute: R/W
 Secondary: BAR + 08h
 Default Value: 00h Size: 8 bits

Bit	Description
7:4	Reserved. Returns 0.
3	Read / Write Control (R/WC) — R/W. This bit sets the direction of the bus master transfer. This bit must NOT be changed when the bus master function is active. 0 = Memory reads 1 = Memory writes
2:1	Reserved. Returns 0.
0	Start/Stop Bus Master (START) — R/W. 0 = All state information is lost when this bit is cleared. Master mode operation cannot be stopped and then resumed. If this bit is reset while bus master operation is still active (that is, the Bus Master IDE Active bit (D31:F2:BAR + 02h, bit 0) of the Bus Master IDE Status register for that IDE channel is set) and the drive has not yet finished its data transfer (the Interrupt bit in the Bus Master IDE Status register for that IDE channel is not set), the bus master command is said to be aborted and data transferred from the drive may be discarded instead of being written to system memory. 1 = Enables bus master operation of the controller. Bus master operation does not actually start unless the Bus Master Enable bit (D31:F2:04h, bit 2) in PCI configuration space is also set. Bus master operation begins when this bit is detected changing from 0 to 1. The controller will transfer data between the IDE device and memory only when this bit is set. Master operation can be halted by writing a 0 to this bit. NOTE: This bit is intended to be cleared by software after the data transfer is completed, as indicated by either the Bus Master IDE Active bit being cleared or the Interrupt bit of the Bus Master IDE Status register for that IDE channel being set, or both. Hardware does not clear this bit automatically. If this bit is cleared to 0 prior to the DMA data transfer being initiated by the drive in a device to memory data transfer, then the PCH will not send DMAT to terminate the data transfer. SW intervention (such as, sending SRST) is required to reset the interface in this condition.



14.2.2 BMIS[P,S]—Bus Master IDE Status Register (D31:F2)

Address Offset: Primary: BAR + 02h Attribute: R/W, R/WC, RO
Secondary: BAR + 0Ah
Default Value: 00h Size: 8 bits

Bit	Description
7	Simplex Only — RO. 0 = Both bus master channels (primary and secondary) can be operated independently and can be used at the same time. 1 = Only one channel may be used at the same time.
6	Drive 1 DMA Capable — R/W. 0 = Not Capable. 1 = Capable. Set by device dependent code (BIOS or device driver) to indicate that drive 1 for this channel is capable of DMA transfers, and that the controller has been initialized for optimum performance. The PCH does not use this bit. It is intended for systems that do not attach BMIDE to the PCI bus.
5	Drive 0 DMA Capable — R/W. 0 = Not Capable 1 = Capable. Set by device dependent code (BIOS or device driver) to indicate that drive 0 for this channel is capable of DMA transfers, and that the controller has been initialized for optimum performance. The PCH does not use this bit. It is intended for systems that do not attach BMIDE to the PCI bus.
4:3	Reserved. Returns 0.
2	Interrupt — R/WC. 0 = Software clears this bit by writing a 1 to it. 1 = Set when a device FIS is received with the 'I' bit set, provided that software has not disabled interrupts using the IEN bit of the Device Control Register (see chapter 5 of the <i>Serial ATA Specification</i> , Revision 1.0a).
1	Error — R/WC. 0 = Software clears this bit by writing a 1 to it. 1 = This bit is set when the controller encounters a target abort or master abort when transferring data on PCI.
0	Bus Master IDE Active (ACT) — RO. 0 = This bit is cleared by the PCH when the last transfer for a region is performed, where EOT for that region is set in the region descriptor. It is also cleared by the PCH when the Start Bus Master bit (D31:F2:BAR+ 00h, bit 0) is cleared in the Command register. When this bit is read as a 0, all data transferred from the drive during the previous bus master command is visible in system memory, unless the bus master command was aborted. 1 = Set by the PCH when the Start bit is written to the Command register.



14.2.3 BMID[P,S]—Bus Master IDE Descriptor Table Pointer Register (D31:F2)

Address Offset: Primary: BAR + 04h–07h Attribute: R/W
 Secondary: BAR + 0Ch–0Fh
 Default Value: All bits undefined Size: 32 bits

Bit	Description
31:2	Address of Descriptor Table (ADDR) — R/W. The bits in this field correspond to bits [31:2] of the memory location of the Physical Region Descriptor (PRD). The Descriptor Table must be Dword-aligned. The Descriptor Table must not cross a 64-K boundary in memory.
1:0	Reserved

14.2.4 AIR—AHCI Index Register (D31:F2)

Address Offset: Primary: BAR + 10h Attribute: R/W
 Default Value: 00000000h Size: 32 bits

This register is available only when SCC is not 01h.

Bit	Description
31:11	Reserved
10:2	Index (INDEX) — R/W. This Index register is used to select the Dword offset of the Memory Mapped AHCI register to be accessed. A Dword, Word or Byte access is specified by the active byte enables of the I/O access to the Data register.
1:0	Reserved

14.2.5 AIDR—AHCI Index Data Register (D31:F2)

Address Offset: Primary: BAR + 14h Attribute: R/W
 Default Value: All bits undefined Size: 32 bits

This register is available only when SCC is not 01h.

Bit	Description
31:0	Data (DATA) — R/W: This Data register is a “window” through which data is read or written to the AHCI memory mapped registers. A read or write to this Data register triggers a corresponding read or write to the memory mapped register pointed to by the Index register. The Index register must be setup prior to the read or write to this Data register. Note that a physical register is not actually implemented as the data is actually stored in the memory mapped registers. Since this is not a physical register, the “default” value is the same as the default value of the register pointed to by Index.



14.3 Serial ATA Index/Data Pair Superset Registers

All of these I/O registers are in the core well. They are exposed only when SCC is 01h (that is, IDE programming interface).

These are Index/Data Pair registers that are used to access the SerialATA superset registers (SerialATA Status (PxSSTS), SerialATA Control (PxSCTL) and SerialATA Error (PxSERR)). The I/O space for these registers is allocated through SIDPBA. Locations with offset from 08h to 0Fh are reserved for future expansion. Software-write operations to the reserved locations will have no effect while software-read operations to the reserved locations will return 0.

Offset M	nemonic	Register
00h–03h	SINDEX	Serial ATA Index
04h–07h	SDATA	Serial ATA Data
08h–0Ch	—	Reserved
0Ch–0Fh	—	Reserved

14.3.1 SINDEX—Serial ATA Index Register (D31:F2)

Address Offset: SIDPBA + 00h
Default Value: 00000000h

Attribute: R/W
Size: 32 bits

Bit	Description
31:16	Reserved
15:8	<p>Port Index (PIDX)—R/W. This Index field is used to specify the port of the SATA controller at which the port-specific SSTS, SCTL, and SERR registers are located.</p> <p>00h = Primary Master (Port 0) 01h = Primary Slave (Port 2) 02h = Secondary Master (Port 1) 03h = Secondary Slave (Port 3) All other values are Reserved.</p>
7:0	<p>Register Index (RIDX)—R/W. This index field is used to specify one out of three registers currently being indexed into. These three registers are the Serial ATA superset SStatus, SControl and SError memory registers and are port specific, hence for this SATA controller, there are four sets of these registers. Refer to Section 14.4.2.10, Section 14.4.2.11, and Section 14.4.2.12 for definitions of the SStatus, SControl and SError registers.</p> <p>00h = SSTS 01h = SCTL 02h = SERR All other values are Reserved.</p>



14.3.2 SDATA—Serial ATA Data Register (D31:F2)

Address Offset: SIDPBA + 04h Attribute: R/W
 Default Value: 00000000h Size: 32 bits

Bit	Description
31:0	<p>Data (DATA)—R/W. This Data register is a “window” through which data is read or written to from the register pointed to by the Serial ATA Index (SINDX) register above. Note that a physical register is not actually implemented as the data is actually stored in the memory mapped registers.</p> <p>Since this is not a physical register, the “default” value is the same as the default value of the register pointed to by SINDX.RIDX field.</p>

14.3.2.1 PxSSTS—Serial ATA Status Register (D31:F2)

Address Offset: Attribute: RO
 Default Value: 00000000h Size: 32 bits

SDATA when SINDX.RIDX is 00h. This is a 32-bit register that conveys the current state of the interface and host. The PCH updates it continuously and asynchronously. When the PCH transmits a COMRESET to the device, this register is updated to its reset values.

Bit	Description										
31:12	Reserved										
11:8	<p>Interface Power Management (IPM) — RO. Indicates the current interface state:</p> <table border="1"> <thead> <tr> <th>Value</th> <th>Description</th> </tr> </thead> <tbody> <tr> <td>0h</td> <td>Device not present or communication not established</td> </tr> <tr> <td>1h</td> <td>Interface in active state</td> </tr> <tr> <td>2h</td> <td>Interface in PARTIAL power management state</td> </tr> <tr> <td>6h</td> <td>Interface in SLUMBER power management state</td> </tr> </tbody> </table> <p>All other values reserved.</p>	Value	Description	0h	Device not present or communication not established	1h	Interface in active state	2h	Interface in PARTIAL power management state	6h	Interface in SLUMBER power management state
Value	Description										
0h	Device not present or communication not established										
1h	Interface in active state										
2h	Interface in PARTIAL power management state										
6h	Interface in SLUMBER power management state										
7:4	<p>Current Interface Speed (SPD) — RO. Indicates the negotiated interface communication speed.</p> <table border="1"> <thead> <tr> <th>Value</th> <th>Description</th> </tr> </thead> <tbody> <tr> <td>0h</td> <td>Device not present or communication not established</td> </tr> <tr> <td>1h</td> <td>Generation 1 communication rate negotiated</td> </tr> <tr> <td>2h</td> <td>Generation 2 communication rate negotiated</td> </tr> <tr> <td>3h</td> <td>Generation 3 communication rate negotiated</td> </tr> </tbody> </table> <p>All other values reserved The PCH Supports Generation 1 communication rates (1.5 Gb/s), Gen 2 rates (3.0 Gb/s) and Gen 3 rates (6.0Gb/s)</p>	Value	Description	0h	Device not present or communication not established	1h	Generation 1 communication rate negotiated	2h	Generation 2 communication rate negotiated	3h	Generation 3 communication rate negotiated
Value	Description										
0h	Device not present or communication not established										
1h	Generation 1 communication rate negotiated										
2h	Generation 2 communication rate negotiated										
3h	Generation 3 communication rate negotiated										
3:0	<p>Device Detection (DET) — RO. Indicates the interface device detection and Phy state:</p> <table border="1"> <thead> <tr> <th>Value</th> <th>Description</th> </tr> </thead> <tbody> <tr> <td>0h</td> <td>No device detected and Phy communication not established</td> </tr> <tr> <td>1h</td> <td>Device presence detected but Phy communication not established</td> </tr> <tr> <td>3h</td> <td>Device presence detected and Phy communication established</td> </tr> <tr> <td>4h</td> <td>Phy in offline mode as a result of the interface being disabled or running in a BIST loopback mode</td> </tr> </tbody> </table> <p>All other values reserved.</p>	Value	Description	0h	No device detected and Phy communication not established	1h	Device presence detected but Phy communication not established	3h	Device presence detected and Phy communication established	4h	Phy in offline mode as a result of the interface being disabled or running in a BIST loopback mode
Value	Description										
0h	No device detected and Phy communication not established										
1h	Device presence detected but Phy communication not established										
3h	Device presence detected and Phy communication established										
4h	Phy in offline mode as a result of the interface being disabled or running in a BIST loopback mode										



14.3.2.3 PxSERR—Serial ATA Error Register (D31:F2)

Address Offset: Attribute: R/WC
 Default Value: 00000000h Size: 32 bits

SDATA when SINDx.RIDX is 02h.

Bits 26:16 of this register contains diagnostic error information for use by diagnostic software in validating correct operation or isolating failure modes. Bits 11:0 contain error information used by host software in determining the appropriate response to the error condition. If one or more of bits 11:8 of this register are set, the controller will stop the current transfer.

Bit	Description
31:27	Reserved
26	Exchanged (X) . When set to one, this bit indicates that a change in device presence has been detected since the last time this bit was cleared. This bit shall always be set to 1 anytime a COMINIT signal is received. This bit is reflected in the P0IS.PCS bit.
25	Unrecognized FIS Type (F) . Indicates that one or more FISs were received by the Transport layer with good CRC, but had a type field that was not recognized.
24	Transport state transition error (T) . Indicates that an error has occurred in the transition from one state to another within the Transport layer since the last time this bit was cleared.
23	Link Sequence Error (S) . Indicates that one or more Link state machine error conditions was encountered. The Link Layer state machine defines the conditions under which the link layer detects an erroneous transition.
22	Handshake (H) . Indicates that one or more R_ERR handshake response was received in response to frame transmission. Such errors may be the result of a CRC error detected by the recipient, a disparity or 8b/10b decoding error, or other error condition leading to a negative handshake on a transmitted frame.
21	CRC Error (C) . Indicates that one or more CRC errors occurred with the Link Layer.
20	Disparity Error (D) . This field is not used by AHCI.
19	10b to 8b Decode Error (B) . Indicates that one or more 10b to 8b decoding errors occurred.
18	Comm Wake (W) . Indicates that a Comm Wake signal was detected by the Phy.
17	Phy Internal Error (I) . Indicates that the Phy detected some internal error.
16	PhyRdy Change (N) . When set to 1, this bit indicates that the internal PhyRdy signal changed state since the last time this bit was cleared. In the PCH, this bit will be set when PhyRdy changes from a 0 -> 1 or a 1 -> 0. The state of this bit is then reflected in the PxIS.PRCS interrupt status bit and an interrupt will be generated if enabled. Software clears this bit by writing a 1 to it.
15:12	Reserved
11	Internal Error (E) . The SATA controller failed due to a master or target abort when attempting to access system memory.
10	Protocol Error (P) . A violation of the Serial ATA protocol was detected. Note: The PCH does not set this bit for all protocol violations that may occur on the SATA link.
9	Persistent Communication or Data Integrity Error (C) . A communication error that was not recovered occurred that is expected to be persistent. Persistent communications errors may arise from faulty interconnect with the device, from a device that has been removed or has failed, or a number of other causes.

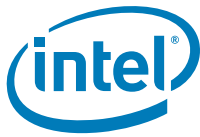

Bit	Description
8	Transient Data Integrity Error (T) : A data integrity error occurred that was not recovered by the interface.
7:2	Reserved
1	Recovered Communications Error (M) . Communications between the device and host was temporarily lost but was re-established. This can arise from a device temporarily being removed, from a temporary loss of Phy synchronization, or from other causes and may be derived from the PhyNRdy signal between the Phy and Link layers.
0	Recovered Data Integrity Error (I) . A data integrity error occurred that was recovered by the interface through a retry operation or other recovery action.

14.4 AHCI Registers (D31:F2)

Note:

These registers are AHCI-specific and available when the PCH is properly configured. The Serial ATA Status, Control, and Error registers are special exceptions and may be accessed on all PCH components if properly configured; see [Section 14.3](#) for details.

The memory mapped registers within the SATA controller exist in non-cacheable memory space. Additionally, locked accesses are not supported. If software attempts to perform locked transactions to the registers, indeterminate results may occur. Register accesses shall have a maximum size of 64-bits; 64-bit access must not cross an 8-byte alignment boundary. All memory registers are reset by Function Level Reset unless specified otherwise.

The registers are broken into two sections – generic host control and port control. The port control registers are the same for all ports, and there are as many registers banks as there are ports.

Table 14-3. AHCI Register Address Map

ABAR + Offset	Mnemonic	Register
00–1Fh	GHC	Generic Host Control
20h–FFh	—	Reserved
100h–17Fh	P0PCR	Port 0 port control registers
180h–1FFh	P1PCR	Port 1 port control registers
200h–27Fh	P2PCR	Port 2 port control registers NOTE: Registers may be Reserved depending on if port is available in the given SKU. See Section 1.3 for details if port is available.
280h–2FFh	P3PCR	Port 3 port control registers NOTE: Registers may be Reserved depending on if port is available in the given SKU. See Section 1.3 for details if port is available.
300h–37Fh	P4PCR	Port 4 port control registers
380h–3FFh	P5PCR	Port 5 port control registers



14.4.1 AHCI Generic Host Control Registers (D31:F2)

Table 14-4. Generic Host Controller Register Address Map

ABAR + Offset	Mnemonic	Register	Default	Attribute
00h–03h	CAP	Host Capabilities	FF22FFC2h (desktop) DE127F03h (mobile)	R/WO, RO
04h–07h	GHC	Global PCH Control	00000000h	R/W, RO
08h–0Bh	IS	Interrupt Status	00000000h	R/WC
0Ch–0Fh	PI	Ports Implemented	00000000h	R/WO, RO
10h–13h	VS	AHCI Version	00010300h	RO
1Ch–1Fh	EM_LOC	Enclosure Management Location	01600002h	RO
20h–23h	EM_CTRL	Enclosure Management Control	07010000h	R/W, R/WO, RO
24h–27h	CAP2	HBA Capabilities Extended	00000004h	RO
A0h–A3h	VSP	Vendor Specific	00000001h	RO, R/WO
C8h–C9h	RSTF	Intel® RST Feature Capabilities	003Fh	R/WO

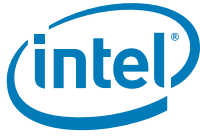

14.4.1.1 CAP—Host Capabilities Register (D31:F2)

Address Offset: ABAR + 00h–03h Attribute: R/WO, RO
 Default Value: FF22FFC2h (Desktop) Size: 32 bits
 DE127F03h (Mobile)
 Function Level Reset: No

All bits in this register that are R/WO are reset only by PLTRST#.

Bit	Description
31	Supports 64-bit Addressing (S64A) — RO. Indicates that the SATA controller can access 64-bit data structures. The 32-bit upper bits of the port DMA Descriptor, the PRD Base, and each PRD entry are read/write.
30	Supports Command Queue Acceleration (SCQA) — R/WO. When set to 1, indicates that the SATA controller supports SATA command queuing using the DMA Setup FIS. The PCH handles DMA Setup FISes natively, and can handle auto-activate optimization through that FIS.
29	Supports SNotification Register (SSNTF) — RO. The PCH SATA Controller does not support the SNotification register.
28	Supports Mechanical Presence Switch (SMPS) — R/WO. When set to 1, indicates whether the SATA controller supports mechanical presence switches on its ports for use in Hot Plug operations. This value is loaded by platform BIOS prior to OS initialization. If this bit is set, BIOS must also map the SATAGP pins to the SATA controller through GPIO space.
27	Supports Staggered Spin-up (SSS) — R/WO. Indicates whether the SATA controller supports staggered spin-up on its ports, for use in balancing power spikes. This value is loaded by platform BIOS prior to OS initialization. 0 = Staggered spin-up not supported. 1 = Staggered spin-up supported.
26	Supports Aggressive Link Power Management (SALP) — R/WO. 0 = Software shall treat the PxCMD.ALPE and PxCMD.ASP bits as reserved. 1 = The SATA controller supports auto-generating link requests to the partial or slumber states when there are no commands to process.
25	Supports Activity LED (SAL) — RO. Indicates that the SATA controller supports a single output pin (SATALED#) which indicates activity.
24	Supports Command List Override (SCLO) — R/WO. When set to 1, indicates that the Controller supports the PxCMD.CLO bit and its associated function. When cleared to 0, the Controller is not capable of clearing the BSY and DRQ bits in the Status register in order to issue a software reset if these bits are still set from a previous operation.
23:20	Interface Speed Support (ISS) — R/WO. Indicates the maximum speed the SATA controller can support on its ports. 1h = 1.5 Gb/s; 2h = 3 Gb/s; 3h = 6 Gb/s The default of this field is dependent upon the PCH SKU. If at least one PCH SATA port supports 6 Gb/s, the default will be 3h. If no PCH SATA ports support 6 Gb/s, then the default will be 2h and writes of 3h will be ignored by the PCH. See Section 1.3 for details on 6 Gb/s port availability.
19	Supports Non-Zero DMA Offsets (SNZO) — RO. Reserved, as per the AHCI Revision 1.3 specification



Bit	Description
18	Supports AHCI Mode Only (SAM) — RO. The SATA controller may optionally support AHCI access mechanism only. 0 = SATA controller supports both IDE and AHCI Modes 1 = SATA controller supports AHCI Mode Only
17	Supports Port Multiplier (PMS) — R/WO. The PCH SATA controller does not support Port Multipliers. BIOS must clear this bit by writing a 0 to this field.
16	Reserved
15	PIO Multiple DRQ Block (PMD) — RO. Hardwired to 1. The SATA controller supports PIO Multiple DRQ Command Block
14	Slumber State Capable (SSC) — R/WO. When set to 1, the SATA controller supports the slumber state.
13	Partial State Capable (PSC) — R/WO. When set to 1, the SATA controller supports the partial state.
12:8	Number of Command Slots (NCS) — RO. Hardwired to 1Fh to indicate support for 32 slots.
7	Command Completion Coalescing Supported (CCCS) — R/WO. 0 = Command Completion Coalescing Not Supported 1 = Command Completion Coalescing Supported
6	Enclosure Management Supported (EMS) — R/WO. 0 = Enclosure Management Not Supported 1 = Enclosure Management Supported
5	Supports External SATA (SXS) — R/WO. 0 = External SATA is not supported on any ports 1 = External SATA is supported on one or more ports When set, SW can examine each SATA port's Command Register (PxCMD) to determine which port is routed externally.
4:0	Number of Ports (NPS) — RO. Indicates number of supported ports. Note that the number of ports indicated in this field may be more than the number of ports indicated in the PI (ABAR + 0Ch) register. Field value dependent on number of ports available in a given SKU. See Section 1.3 for details.

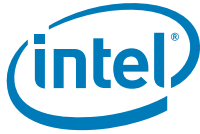

14.4.1.2 GHC—Global PCH Control Register (D31:F2)

Address Offset: ABAR + 04h–07h Attribute: R/W, RO
 Default Value: 00000000h Size: 32 bits

Bit	Description
31	<p>AHCI Enable (AE) — R/W. When set, this bit indicates that an AHCI driver is loaded and the controller will be talked to using AHCI mechanisms. This can be used by a PCH that supports both legacy mechanisms (such as SFF-8038i) and AHCI to know when the controller will not be talked to as legacy.</p> <p>0 = Software will communicate with the PCH using legacy mechanisms. 1 = Software will communicate with the PCH using AHCI. The PCH will not have to allow command processing using both AHCI and legacy mechanisms.</p> <p>Software shall set this bit to 1 before accessing other AHCI registers.</p>
30:3	Reserved
2	<p>MSI Revert to Single Message (MRSM) — RO: When set to 1 by hardware, this bit indicates that the host controller requested more than one MSI vector but has reverted to using the first vector only. When this bit is cleared to 0, the Controller has not reverted to single MSI mode (that is, hardware is already in single MSI mode, software has allocated the number of messages requested, or hardware is sharing interrupt vectors if MC.MME < MC.MMC).</p> <p>"MC.MSIE = 1 (MSI is enabled) "MC.MMC > 0 (multiple messages requested) "MC.MME > 0 (more than one message allocated) "MC.MME!= MC.MMC (messages allocated not equal to number requested)</p> <p>When this bit is set to 1, single MSI mode operation is in use and software is responsible for clearing bits in the IS register to clear interrupts.</p> <p>This bit shall be cleared to 0 by hardware when any of the four conditions stated is false. This bit is also cleared to 0 when MC.MSIE = 1 and MC.MME = 0h. In this case, the hardware has been programmed to use single MSI mode, and is not "reverting" to that mode.</p> <p>For PCH, the Controller shall always revert to single MSI mode when the number of vectors allocated by the host is less than the number requested. This bit is ignored when GHC.HR = 1.</p>
1	<p>Interrupt Enable (IE) — R/W. This global bit enables interrupts from the PCH.</p> <p>0 = All interrupt sources from all ports are disabled. 1 = Interrupts are allowed from the AHCI controller.</p>
0	<p>Controller Reset (HR) — R/W. Resets the PCH AHCI controller.</p> <p>0 = No effect 1 = When set by software, this bit causes an internal reset of the PCH AHCI controller. All state machines that relate to data transfers and queuing return to an idle condition, and all ports are re-initialized using COMRESET.</p> <p>NOTE: For further details, consult Section 10.4.3 of the Serial ATA Advanced Host Controller Interface specification revision 1.3.</p>



14.4.1.3 IS—Interrupt Status Register (D31:F2)

Address Offset: ABAR + 08h–0Bh Attribute: R/WC
 Default Value: 00000000h Size: 32 bits

This register indicates which of the ports within the controller have an interrupt pending and require service.

Bit	Description
31:6	Reserved. Returns 0.
5	Interrupt Pending Status Port[5] (IPS[5]) — R/WC. 0 = No interrupt pending. 1 = Port 5 has an interrupt pending. Software can use this information to determine which ports require service after an interrupt.
4	Interrupt Pending Status Port[4] (IPS[4]) — R/WC. 0 = No interrupt pending. 1 = Port 4 has an interrupt pending. Software can use this information to determine which ports require service after an interrupt.
3	Interrupt Pending Status Port[3] (IPS[3]) — R/WC. 0 = No interrupt pending. 1 = Port 3 has an interrupt pending. Software can use this information to determine which ports require service after an interrupt. NOTE: Bit may be Reserved depending on if port is available in the given SKU. See Section 1.3 for details if port is available.
2	Interrupt Pending Status Port[2] (IPS[2]) — R/WC. 0 = No interrupt pending. 1 = Port 2 has an interrupt pending. Software can use this information to determine which ports require service after an interrupt. NOTE: Bit may be Reserved depending on if port is available in the given SKU. See Section 1.3 for details if port is available.
1	Interrupt Pending Status Port[1] (IPS[1]) — R/WC. 0 = No interrupt pending. 1 = Port 1 has an interrupt pending. Software can use this information to determine which ports require service after an interrupt.
0	Interrupt Pending Status Port[0] (IPS[0]) — R/WC. 0 = No interrupt pending. 1 = Port 0 has an interrupt pending. Software can use this information to determine which ports require service after an interrupt.



14.4.1.4 PI—Ports Implemented Register (D31:F2)

Address Offset: ABAR + 0Ch–0Fh Attribute: R/WO, RO
Default Value: 00000000h Size: 32 bits
Function Level Reset: No

This register indicates which ports are exposed to the PCH. It is loaded by platform BIOS. It indicates which ports that the device supports are available for software to use. For ports that are not available, software must not read or write to registers within that port. After BIOS issues initial write to this register, BIOS is requested to issue two reads to this register. If BIOS accesses any of the port specific AHCI address range before setting PI bit, BIOS is required to read the PI register before the initial write to the PI register.

Bit	Description
31:6	Reserved. Returns 0.
5	Ports Implemented Port 5 (PI5) — R/WO. 0 = The port is not implemented. 1 = The port is implemented. This bit is read-only 0 if MAP.SC = 0 or SCC = 01h.
4	Ports Implemented Port 4 (PI4) — R/WO. 0 = The port is not implemented. 1 = The port is implemented. This bit is read-only 0 if MAP.SC = 0 or SCC = 01h.
3	Ports Implemented Port 3 (PI3) — R/WO. 0 = The port is not implemented. 1 = The port is implemented. NOTE: Bit may be Reserved and RO '0' depending on if port is available in the given SKU. See Section 1.3 for details if port is available.
2	Ports Implemented Port 2 (PI2) — R/WO. 0 = The port is not implemented. 1 = The port is implemented. NOTE: Bit may be Reserved and RO '0' depending on if port is available in the given SKU. See Section 1.3 for details if port is available.
1	Ports Implemented Port 1 (PI1) — R/WO. 0 = The port is not implemented. 1 = The port is implemented.
0	Ports Implemented Port 0 (PI0) — R/WO. 0 = The port is not implemented. 1 = The port is implemented.



14.4.1.5 VS—AHCI Version Register (D31:F2)

Address Offset: ABAR + 10h–13h Attribute: RO
 Default Value: 00010300h Size: 32 bits

This register indicates the major and minor version of the AHCI specification. It is BCD encoded. The upper two bytes represent the major version number, and the lower two bytes represent the minor version number. Example: Version 3.12 would be represented as 00030102h. The current version of the specification is 1.30 (00010300h).

Bit	Description
31:16	Major Version Number (MJR) — RO. Indicates the major version is 1
15:0	Minor Version Number (MNR) — RO. Indicates the minor version is 30.

14.4.1.6 EM_LOC—Enclosure Management Location Register (D31:F2)

Address Offset: ABAR + 1Ch–1Fh Attribute: RO
 Default Value: 01600002h Size: 32 bits

This register identifies the location and size of the enclosure management message buffer. This register is reserved if enclosure management is not supported (that is, CAP.EMS = 0).

Bit	Description
31:16	Offset (OFST) — RO. The offset of the message buffer in Dwords from the beginning of the ABAR.
15:0	Buffer Size (SZ) — RO. Specifies the size of the transmit message buffer area in Dwords. The PCH SATA controller only supports transmit buffer. A value of 0 is invalid.



14.4.1.7 EM_CTRL—Enclosure Management Control Register (D31:F2)

Address Offset: ABAR + 20h–23h Attribute: R/W, R/WO, RO
 Default Value: 07010000h Size: 32 bits

This register is used to control and obtain status for the enclosure management interface. This register includes information on the attributes of the implementation, enclosure management messages supported, the status of the interface, whether any message are pending, and is used to initiate sending messages. This register is reserved if enclosure management is not supported (CAP_EMS = 0).

Bit	Description
31:27	Reserved
26	Activity LED Hardware Driven (ATTR.ALHD) — R/WO. 1 = The SATA controller drives the activity LED for the LED message type in hardware and does not utilize software for this LED. The host controller does not begin transmitting the hardware based activity signal until after software has written CTL.TM=1 after a reset condition.
25	Transmit Only (ATTR.XMT) — RO. 0 = The SATA controller supports transmitting and receiving messages. 1 = The SATA controller only supports transmitting messages and does not support receiving messages.
24	Single Message Buffer (ATTR.SMB) — RO. 0 = There are separate receive and transmit buffers such that unsolicited messages could be supported. 1 = The SATA controller has one message buffer that is shared for messages to transmit and messages received. Unsolicited receive messages are not supported and it is software’s responsibility to manage access to this buffer.
23:20	Reserved
19	SGPIO Enclosure Management Messages (SUPP.SGPIO) — RO. 1 = The SATA controller supports the SGPIO register interface message type.
18	SES-2 Enclosure Management Messages (SUPP.SES2) — RO. 1 = The SATA controller supports the SES-2 message type.
17	SAF-TE Enclosure Management Messages (SUPP.SAFTE) — RO. 1 = The SATA controller supports the SAF-TE message type.
16	LED Message Types (SUPP.LED) — RO. 1 = The SATA controller supports the LED message type.
15:10	Reserved
9	Reset (RST): — R/W. 0 = A write of 0 to this bit by software will have no effect. 1 = When set by software, The SATA controller resets all enclosure management message logic and takes all appropriate reset actions to ensure messages can be transmitted / received after the reset. After the SATA controller completes the reset operation, the SATA controller sets the value to 0.
8	Transmit Message (CTL.TM) — R/W. 0 = A write of 0 to this bit by software will have no effect. 1 = When set by software, The SATA controller transmits the message contained in the message buffer. When the message is completely sent, the SATA controller sets the value to 0. Software must not change the contents of the message buffer while CTL.TM is set to 1.
7:1	Reserved
0	Message Received (STS.MR): — RO. Message Received is not supported in the PCH.



14.4.1.8 CAP2—HBA Capabilities Extended Register

Address Offset: ABAR + 24h–27h Attribute: RO
 Default Value: 00000004h Size: 32 bits
 Function Level Reset: No

Bit	Description
31:3	Reserved
2	Automatic Partial to Slumber Transitions (APST) 0= Not supported 1= Supported
1:0	Reserved

14.4.1.9 VSP—Vendor Specific Register (D31:F2)

Address Offset: ABAR + A0h–A3h Attribute: RO, R/WO
 Default Value: 00000001h Size: 32 bits

Bit	Description
31:1	Reserved
0	SATA Initalization Field — R/WO BIOS must clear this bit by writing a 0 to this field.



14.4.1.10 RSTF—Intel® RST Feature Capabilities Register

Address Offset: ABAR + C8h–C9h Attribute: R/WO
 Default Value: 003Fh Size: 16 bits
 Function Level Reset: No

No hardware action is taken on this register. This register is needed for the Intel® Rapid Storage Technology software. These bits are set by BIOS to request the feature from the appropriate Intel Rapid Storage Technology software.

Bit	Description
15:12	Reserved
11:10	OROM UI Normal Delay (OUD) — R/WO. The values of these bits specify the delay of the OROM UI Splash Screen in a normal status. 00 = 2 Seconds (Default) 01 = 4 Seconds 10 = 6 Seconds 11 = 8 Seconds If bit 5 = 0b these values will be disregarded.
9	Intel® Smart Response Technology Enable Request (SREQ) — R/WO. Indicates the requested status of the Intel Smart Response Technology support. 0 = Disabled 1 = Enabled
8	Intel® RRT Only on eSATA (ROES) — R/WO Indicates the request that only Intel® Rapid Recovery Technology (RRT) volumes can span internal and external SATA (eSATA). If not set, any RAID volume can span internal and external SATA. 0 = Disabled 1 = Enabled
7	LED Locate (LEDL) — R/WO Indicates the request that the LED/SGPIO hardware is attached and ping to locate feature is enabled in the OS. 0 = Disabled 1 = Enabled
6	HDD Unlock (HDDLK) — R/WO Indicates the requested status of HDD password unlock in the OS. 0 = Disabled 1 = Enabled
5	Intel RST OROM UI (RSTOROMUI) — R/WO. Indicates the requested status of the Intel® RST OROM UI display. 0 = The Intel RST OROM UI and banner are not displayed if all disks and RAID volumes have a normal status. 1 = The Intel RST OROM UI is displayed during each boot.
4	Intel® RRT Enable (RSTE) — R/WO Indicates the requested status of the Intel® Rapid Recovery Technology support. 0 = Disabled 1 = Enabled
3	RAID 5 Enable (R5E) — R/WO Indicates the requested status of RAID 5 support. 0 = Disabled 1 = Enabled



Bit	Description
2	RAID 10 Enable (R10E) – R/WO Indicates the requested status of RAID 10 support. 0 = Disabled 1 = Enabled
1	RAID 1 Enable (R1E) – R/WO Indicates the requested status of RAID 1 support. 0 = Disabled 1 = Enabled
0	RAID 0 Enable (R0E) – R/WO Indicates the requested status of RAID 0 support. 0 = Disabled 1 = Enabled

14.4.2 Port Registers (D31:F2)

Ports not available will result in the corresponding Port DMA register space being reserved. The controller shall ignore writes to the reserved space on write cycles and shall return 0 on read cycle accesses to the reserved location.

Table 14-5. Port [5:0] DMA Register Address Map (Sheet 1 of 3)

ABAR + Offset	Mnemonic	Register
100h–103h	POCLB	Port 0 Command List Base Address
104h–107h	POCLBU	Port 0 Command List Base Address Upper 32-Bits
108h–10Bh	POFB	Port 0 FIS Base Address
10Ch–10Fh	POFBU	Port 0 FIS Base Address Upper 32-Bits
110h–113h	POIS	Port 0 Interrupt Status
114h–117h	POIE	Port 0 Interrupt Enable
118h–11Bh	POCMD	Port 0 Command
11Ch–11Fh	—	Reserved
120h–123h	POTFD	Port 0 Task File Data
124h–127h	POSIG	Port 0 Signature
128h–12Bh	POSSTS	Port 0 Serial ATA Status
12Ch–12Fh	POSCTL	Port 0 Serial ATA Control
130h–133h	POSERR	Port 0 Serial ATA Error
134h–137h	POSACT	Port 0 Serial ATA Active
138h–13Bh	POCI	Port 0 Command Issue
13Ch–17Fh	—	Reserved
180h–183h	P1CLB	Port 1 Command List Base Address
184h–187h	P1CLBU	Port 1 Command List Base Address Upper 32-Bits
188h–18Bh	P1FB	Port 1 FIS Base Address
18Ch–18Fh	P1FBU	Port 1 FIS Base Address Upper 32-Bits
190h–193h	P1IS	Port 1 Interrupt Status
194h–197h	P1IE	Port 1 Interrupt Enable



Table 14-5. Port [5:0] DMA Register Address Map (Sheet 2 of 3)

ABAR + Offset	Mnemonic	Register
198h–19Bh	P1CMD	Port 1 Command
19Ch–19Fh	—	Reserved
1A0h–1A3h	P1TFD	Port 1 Task File Data
1A4h–1A7h	P1SIG	Port 1 Signature
1A8h–1ABh	P1SSTS	Port 1 Serial ATA Status
1ACh–1AFh	P1SCTL	Port 1 Serial ATA Control
1B0h–1B3h	P1SERR	Port 1 Serial ATA Error
1B4h–1B7h	P1SACT	Port 1 Serial ATA Active
1B8h–1BBh	P1CI	Port 1 Command Issue
1BCh–1FFh	—	Reserved
200h–27Fh	—	Registers may be Reserved depending on if port is available in the given SKU. See Section 1.3 for details if port is available.
200h–203h	P2CLB	Port 2 Command List Base Address
204h–207h	P2CLBU	Port 2 Command List Base Address Upper 32-Bits
208h–20Bh	P2FB	Port 2 FIS Base Address
20Ch–20Fh	P2FBU	Port 2 FIS Base Address Upper 32-Bits
210h–213h	P2IS	Port 2 Interrupt Status
214h–217h	P2IE	Port 2 Interrupt Enable
218h–21Bh	P2CMD	Port 2 Command
21Ch–21Fh	—	Reserved
220h–223h	P2TFD	Port 2 Task File Data
224h–227h	P2SIG	Port 2 Signature
228h–22Bh	P2SSTS	Port 2 Serial ATA Status
22Ch–22Fh	P2SCTL	Port 2 Serial ATA Control
230h–233h	P2SERR	Port 2 Serial ATA Error
234h–237h	P2SACT	Port 2 Serial ATA Active
238h–23Bh	P2CI	Port 2 Command Issue
23Ch–27Fh	—	Reserved
280h–2FFh	—	Registers may be Reserved depending on if port is available in the given SKU. See Section 1.3 for details if port is available.
280h–283h	P3CLB	Port 3 Command List Base Address
284h–287h	P3CLBU	Port 3 Command List Base Address Upper 32-Bits
288h–28Bh	P3FB	Port 3 FIS Base Address
28Ch–28Fh	P3FBU	Port 3 FIS Base Address Upper 32-Bits
290h–293h	P3IS	Port 3 Interrupt Status
294h–297h	P3IE	Port 3 Interrupt Enable
298h–29Bh	P3CMD	Port 3 Command
29Ch–29Fh	—	Reserved
2A0h–2A3h	P3TFD	Port 3 Task File Data
2A4h–2A7h	P3SIG	Port 3 Signature

**Table 14-5. Port [5:0] DMA Register Address Map (Sheet 3 of 3)**

ABAR + Offset	Mnemonic	Register
2A8h–2ABh	P3SSTS	Port 3 Serial ATA Status
2ACh–2AFh	P3SCTL	Port 3 Serial ATA Control
2B0h–2B3h	P3SERR	Port 3 Serial ATA Error
2B4h–2B7h	P3SACT	Port 3 Serial ATA Active
2B8h–2BBh	P3CI	Port 3 Command Issue
2BCh–2FFh	—	Reserved
300h–303h	P4CLB	Port 4 Command List Base Address
304h–307h	P4CLBU	Port 4 Command List Base Address Upper 32-Bits
308h–30Bh	P4FB	Port 4 FIS Base Address
30Ch–30Fh	P4FBU	Port 4 FIS Base Address Upper 32-Bits
310h–313h	P4IS	Port 4 Interrupt Status
314h–317h	P4IE	Port 4 Interrupt Enable
318h–31Bh	P4CMD	Port 4 Command
31Ch–31Fh	—	Reserved
320h–323h	P4TFD	Port 4 Task File Data
324h–327h	P4SIG	Port 4 Signature
328h–32Bh	P4SSTS	Port 4 Serial ATA Status
32Ch–32Fh	P4SCTL	Port 4 Serial ATA Control
330h–333h	P4SERR	Port 4 Serial ATA Error
334h–337h	P4SACT	Port 4 Serial ATA Active
338h–33Bh	P4CI	Port 4 Command Issue
33Ch–37Fh	—	Reserved
380h–383h	P5CLB	Port 5 Command List Base Address
384h–387h	P5CLBU	Port 5 Command List Base Address Upper 32-Bits
388h–38Bh	P5FB	Port 5 FIS Base Address
38Ch–38Fh	P5FBU	Port 5 FIS Base Address Upper 32-Bits
390h–393h	P5IS	Port 5 Interrupt Status
394h–397h	P5IE	Port 5 Interrupt Enable
398h–39Bh	P5CMD	Port 5 Command
39Ch–39Fh	—	Reserved
3A0h–3A3h	P5TFD	Port 5 Task File Data
3A4h–3A7h	P5SIG	Port 5 Signature
3A8h–3ABh	P5SSTS	Port 5 Serial ATA Status
3ACh–3AFh	P5SCTL	Port 5 Serial ATA Control
3B0h–3B3h	P5SERR	Port 5 Serial ATA Error
3B4h–3B7h	P5SACT	Port 5 Serial ATA Active
3B8h–3BBh	P5CI	Port 5 Command Issue
3BCh–FFFh	—	Reserved

**14.4.2.1 PxCLB—Port [5:0] Command List Base Address Register (D31:F2)**

Address Offset: Port 0: ABAR + 100h Attribute: R/W
 Port 1: ABAR + 180h
 Port 2: ABAR + 200h (if port available; see [Section 1.3](#))
 Port 3: ABAR + 280h (if port available; see [Section 1.3](#))
 Port 4: ABAR + 300h
 Port 5: ABAR + 380h

Default Value: Undefined Size: 32 bits

Bit	Description
31:10	Command List Base Address (CLB) — R/W. Indicates the 32-bit base for the command list for this port. This base is used when fetching commands to execute. The structure pointed to by this address range is 1 KB in length. This address must be 1-KB aligned as indicated by bits 31:10 being read/write. Note that these bits are not reset on a Controller reset.
9:0	Reserved

14.4.2.2 PxCLBU—Port [5:0] Command List Base Address Upper 32-Bits Register (D31:F2)

Address Offset: Port 0: ABAR + 104h Attribute: R/W
 Port 1: ABAR + 184h
 Port 2: ABAR + 204h (if port available; see [Section 1.3](#))
 Port 3: ABAR + 284h (if port available; see [Section 1.3](#))
 Port 4: ABAR + 304h
 Port 5: ABAR + 384h

Default Value: Undefined Size: 32 bits

Bit	Description
31:0	Command List Base Address Upper (CLBU) — R/W. Indicates the upper 32-bits for the command list base address for this port. This base is used when fetching commands to execute. Note that these bits are not reset on a Controller reset.

14.4.2.3 PxFB—Port [5:0] FIS Base Address Register (D31:F2)

Address Offset: Port 0: ABAR + 108h Attribute: R/W
 Port 1: ABAR + 188h
 Port 2: ABAR + 208h (if port available; see [Section 1.3](#))
 Port 3: ABAR + 288h (if port available; see [Section 1.3](#))
 Port 4: ABAR + 308h
 Port 5: ABAR + 388h

Default Value: Undefined Size: 32 bits

Bit	Description
31:8	FIS Base Address (FB) — R/W. Indicates the 32-bit base for received FISes. The structure pointed to by this address range is 256 bytes in length. This address must be 256-byte aligned, as indicated by bits 31:3 being read/write. Note that these bits are not reset on a Controller reset.
7:0	Reserved



14.4.2.4 PxFBU—Port [5:0] FIS Base Address Upper 32-Bits Register (D31:F2)

Address Offset: Port 0: ABAR + 10Ch Attribute: R/W
 Port 1: ABAR + 18Ch
 Port 2: ABAR + 20Ch (if port available; see [Section 1.3](#))
 Port 3: ABAR + 28Ch (if port available; see [Section 1.3](#))
 Port 4: ABAR + 30Ch
 Port 5: ABAR + 38Ch
 Default Value: Undefined Size: 32 bits

Bit	Description
31:0	FIS Base Address Upper (FBU) — R/W. Indicates the upper 32-bits for the received FIS base for this port. Note that these bits are not reset on a Controller reset.

14.4.2.5 PxIS—Port [5:0] Interrupt Status Register (D31:F2)

Address Offset: Port 0: ABAR + 110h Attribute: R/WC, RO
 Port 1: ABAR + 190h
 Port 2: ABAR + 210h (if port available; see [Section 1.3](#))
 Port 3: ABAR + 290h (if port available; see [Section 1.3](#))
 Port 4: ABAR + 310h
 Port 5: ABAR + 390h
 Default Value: 00000000h Size: 32 bits

Bit	Description
31	Cold Port Detect Status (CPDS) — RO. Cold presence detect is not supported.
30	Task File Error Status (TFES) — R/WC. This bit is set whenever the status register is updated by the device and the error bit (PxTFD.bit 0) is set.
29	Host Bus Fatal Error Status (HBFS) — R/WC. Indicates that the PCH encountered an error that it cannot recover from due to a bad software pointer. In PCI, such an indication would be a target or master abort.
28	Host Bus Data Error Status (HBDS) — R/WC. Indicates that the PCH encountered a data error (uncorrectable ECC / parity) when reading from or writing to system memory.
27	Interface Fatal Error Status (IFS) — R/WC. Indicates that the PCH encountered an error on the SATA interface which caused the transfer to stop.
26	Interface Non-fatal Error Status (INFS) — R/WC. Indicates that the PCH encountered an error on the SATA interface but was able to continue operation.
25	Reserved
24	Overflow Status (OFS) — R/WC. Indicates that the PCH received more bytes from a device than was specified in the PRD table for the command.
23	Incorrect Port Multiplier Status (IPMS) — R/WC. Indicates that the PCH received a FIS from a device whose Port Multiplier field did not match what was expected. NOTE: FIS based Port Multipliers are not supported by the PCH.



Bit	Description
22	<p>PhyRdy Change Status (PRCS) — RO. When set to one, this bit indicates the internal PhyRdy signal changed state. This bit reflects the state of PxSERR.DIAG.N. Unlike most of the other bits in the register, this bit is RO and is only cleared when PxSERR.DIAG.N is cleared.</p> <p>Note that the internal PhyRdy signal also transitions when the port interface enters partial or slumber power management states. Partial and slumber must be disabled when Surprise Removal Notification is desired, otherwise the power management state transitions will appear as false insertion and removal events.</p>
21:8	Reserved
7	<p>Device Interlock Status (DIS) — R/WC. When set, this bit indicates that a platform mechanical presence switch has been opened or closed, which may lead to a change in the connection state of the device. This bit is only valid in systems that support an mechanical presence switch (CAP.SIS [ABAR+00:bit 28] set).</p> <p>For systems that do not support an mechanical presence switch, this bit will always be 0.</p>
6	<p>Port Connect Change Status (PCS) — RO. This bit reflects the state of PxSERR.DIAG.X. (ABAR+130h/1D0h/230h/2D0h, bit 26) Unlike other bits in this register, this bit is only cleared when PxSERR.DIAG.X is cleared.</p> <p>0 = No change in Current Connect Status. 1 = Change in Current Connect Status.</p>
5	<p>Descriptor Processed (DPS) — R/WC. A PRD with the I bit set has transferred all its data.</p>
4	<p>Unknown FIS Interrupt (UFS) — RO. When set to 1, this bit indicates that an unknown FIS was received and has been copied into system memory. This bit is cleared to 0 by software clearing the PxSERR.DIAG.F bit to 0. Note that this bit does not directly reflect the PxSERR.DIAG.F bit. PxSERR.DIAG.F is set immediately when an unknown FIS is detected, whereas this bit is set when the FIS is posted to memory. Software should wait to act on an unknown FIS until this bit is set to 1 or the two bits may become out of sync.</p>
3	<p>Set Device Bits Interrupt (SDBS) — R/WC. A Set Device Bits FIS has been received with the I bit set and has been copied into system memory.</p>
2	<p>DMA Setup FIS Interrupt (DSS) — R/WC. A DMA Setup FIS has been received with the I bit set and has been copied into system memory.</p>
1	<p>PIO Setup FIS Interrupt (PSS) — R/WC. A PIO Setup FIS has been received with the I bit set, it has been copied into system memory, and the data related to that FIS has been transferred.</p>
0	<p>Device to Host Register FIS Interrupt (DHRS) — R/WC. A D2H Register FIS has been received with the I bit set, and has been copied into system memory.</p>



14.4.2.6 PxIE—Port [5:0] Interrupt Enable Register (D31:F2)

Address Offset:	Port 0: ABAR + 114h Port 1: ABAR + 194h Port 2: ABAR + 214h (if port available; see Section 1.3) Port 3: ABAR + 294h (if port available; see Section 1.3) Port 4: ABAR + 314h Port 5: ABAR + 394h	Attribute:	R/W, RO
Default Value:	00000000h	Size:	32 bits

This register enables and disables the reporting of the corresponding interrupt to system software. When a bit is set (1) and the corresponding interrupt condition is active, then an interrupt is generated. Interrupt sources that are disabled (0) are still reflected in the status registers.

Bit	Description
31	Cold Presence Detect Enable (CPDE) — RO. Cold Presence Detect is not supported.
30	Task File Error Enable (TFEE) — R/W. When set, and GHC.IE and PxTFD.STS.ERR (due to a reception of the error register from a received FIS) are set, the PCH will generate an interrupt.
29	Host Bus Fatal Error Enable (HBFE) — R/W. When set, and GHC.IE and PxS.HBFS are set, the PCH will generate an interrupt.
28	Host Bus Data Error Enable (HBDE) — R/W. When set, and GHC.IE and PxS.HBDS are set, the PCH will generate an interrupt.
27	Host Bus Data Error Enable (HBDE) — R/W. When set, GHC.IE is set, and PxIS.HBDS is set, the PCH will generate an interrupt.
26	Interface Non-fatal Error Enable (INFE) — R/W. When set, GHC.IE is set, and PxIS.INFS is set, the PCH will generate an interrupt.
25	Reserved
24	Overflow Error Enable (OFE) — R/W. When set, and GHC.IE and PxS.OFS are set, the PCH will generate an interrupt.
23	Incorrect Port Multiplier Enable (IPME) — R/W. When set, and GHC.IE and PxIS.IPMS are set, the PCH will generate an interrupt. NOTE: FIS based Port Multipliers only supported on SATA ports 4 and 5 by PCH
22	PhyRdy Change Interrupt Enable (PRCE) — R/W. When set, and GHC.IE is set, and PxIS.PRCS is set, the PCH shall generate an interrupt.
21:8	Reserved
7	Device Interlock Enable (DIE) — R/W. When set, and PxIS.DIS is set, the PCH will generate an interrupt. For systems that do not support an mechanical presence switch, this bit shall be a read-only 0.
6	Port Change Interrupt Enable (PCE) — R/W. When set, and GHC.IE and PxS.PCS are set, the PCH will generate an interrupt.
5	Descriptor Processed Interrupt Enable (DPE) — R/W. When set, and GHC.IE and PxS.DPS are set, the PCH will generate an interrupt.
4	Unknown FIS Interrupt Enable (UFIE) — R/W. When set, and GHC.IE is set and an unknown FIS is received, the PCH will generate this interrupt.
3	Set Device Bits FIS Interrupt Enable (SDBE) — R/W. When set, and GHC.IE and PxS.SDBS are set, the PCH will generate an interrupt.
2	DMA Setup FIS Interrupt Enable (DSE) — R/W. When set, and GHC.IE and PxS.DSS are set, the PCH will generate an interrupt.
1	PIO Setup FIS Interrupt Enable (PSE) — R/W. When set, and GHC.IE and PxS.PSS are set, the PCH will generate an interrupt.
0	Device to Host Register FIS Interrupt Enable (DHRE) — R/W. When set, and GHC.IE and PxS.DHRS are set, the PCH will generate an interrupt.



14.4.2.7 PxCMD—Port [5:0] Command Register (D31:F2)

Address Offset: Port 0: ABAR + 118h Attribute: R/W, RO, R/WO
 Port 1: ABAR + 198h
 Port 2: ABAR + 218h (if port available; see Section 1.3)
 Port 3: ABAR + 298h (if port available; see Section 1.3)
 Port 4: ABAR + 318h
 Port 5: ABAR + 398h
 Default Value: 0000w00wh Size: 32 bits
 where w = 00?0b (for?, see bit description)
 Function Level Reset: No (Bit 21, 19 and 18 only)

Bit	Description														
31:28	<p>Interface Communication Control (ICC) — R/W. This is a four bit field that can be used to control reset and power states of the interface. Writes to this field will cause actions on the interface, either as primitives or an OOB sequence, and the resulting status of the interface will be reported in the PxSSTS register (Address offset Port 0: ABAR+124h, Port 1: ABAR+1A4h, Port 2: ABAR+224h, Port 3: ABAR+2A4h, Port 4: ABAR+224h, Port 5: ABAR+2A4h).</p> <table border="1" style="width: 100%; border-collapse: collapse;"> <thead> <tr> <th style="text-align: left;">Value</th> <th style="text-align: left;">Definition</th> </tr> </thead> <tbody> <tr> <td>Fh–7h</td> <td>Reserved</td> </tr> <tr> <td>6h</td> <td>Slumber: This will cause the PCH to request a transition of the interface to the slumber state. The SATA device may reject the request and the interface will remain in its current state</td> </tr> <tr> <td>5h–3h</td> <td>Reserved</td> </tr> <tr> <td>2h</td> <td>Partial: This will cause the PCH to request a transition of the interface to the partial state. The SATA device may reject the request and the interface will remain in its current state.</td> </tr> <tr> <td>1h</td> <td>Active: This will cause the PCH to request a transition of the interface into the active</td> </tr> <tr> <td>0h</td> <td>No-Op / Idle: When software reads this value, it indicates the PCH is not in the process of changing the interface state or sending a device reset, and a new link command may be issued.</td> </tr> </tbody> </table> <p>When system software writes a non-reserved value other than No-Op (0h), the PCH will perform the action and update this field back to Idle (0h). If software writes to this field to change the state to a state the link is already in (such as, interface is in the active state and a request is made to go to the active state), the PCH will take no action and return this field to Idle. NOTE: When the ALPE bit (bit 26) is set, then this register should not be set to 02h or 06h.</p>	Value	Definition	Fh–7h	Reserved	6h	Slumber: This will cause the PCH to request a transition of the interface to the slumber state. The SATA device may reject the request and the interface will remain in its current state	5h–3h	Reserved	2h	Partial: This will cause the PCH to request a transition of the interface to the partial state. The SATA device may reject the request and the interface will remain in its current state.	1h	Active: This will cause the PCH to request a transition of the interface into the active	0h	No-Op / Idle: When software reads this value, it indicates the PCH is not in the process of changing the interface state or sending a device reset, and a new link command may be issued.
Value	Definition														
Fh–7h	Reserved														
6h	Slumber: This will cause the PCH to request a transition of the interface to the slumber state. The SATA device may reject the request and the interface will remain in its current state														
5h–3h	Reserved														
2h	Partial: This will cause the PCH to request a transition of the interface to the partial state. The SATA device may reject the request and the interface will remain in its current state.														
1h	Active: This will cause the PCH to request a transition of the interface into the active														
0h	No-Op / Idle: When software reads this value, it indicates the PCH is not in the process of changing the interface state or sending a device reset, and a new link command may be issued.														
27	<p>Aggressive Slumber / Partial (ASP) — R/W. When set to 1, and the ALPE bit (bit 26) is set, the PCH shall aggressively enter the slumber state when it clears the PxCI register and the PxSACT register is cleared. When cleared, and the ALPE bit is set, the PCH will aggressively enter the partial state when it clears the PxCI register and the PxSACT register is cleared. If CAP.SALP is cleared to 0, software shall treat this bit as reserved.</p>														
26	<p>Aggressive Link Power Management Enable (ALPE) — R/W. When set to 1, the PCH will aggressively enter a lower link power state (partial or slumber) based upon the setting of the ASP bit (bit 27).</p>														



Bit	Description
25	Drive LED on ATAPI Enable (DLAE) — R/W. When set to 1, the PCH will drive the LED pin active for ATAPI commands (PxCLB[CHz.A] set) in addition to ATA commands. When cleared, the PCH will only drive the LED pin active for ATA commands. See Section 5.16.11 for details on the activity LED.
24	Device is ATAPI (ATAPI) — R/W. When set to 1, the connected device is an ATAPI device. This bit is used by the PCH to control whether or not to generate the desktop LED when commands are active. See Section 5.16.11 for details on the activity LED.
23	Automatic Partial Slumber Transitions Enabled (APSTE) — R/W. 0 = This port will not perform Automatic Partial to Slumber Transitions. 1 = The HBA may perform Automatic Partial to Slumber Transitions. NOTE: Software should only set this bit to '1' if CAP2.APST is set to '1'.
22	SATA Initialization Field — R/WO BIOS must write a 0 to this field. This field is not reset by FLR.
21	External SATA Port (ESP) — R/WO. 0 = This port supports internal SATA devices only. 1 = This port will be used with an external SATA device and hot plug is supported. When set, CAP.SXS must also be set. This bit is not reset by Function Level Reset.
20	Reserved
19	Mechanical Switch Attached to Port (MPSP) — R/WO. If set to 1, the PCH supports a mechanical presence switch attached to this port. The PCH takes no action on the state of this bit – it is for system software only. For example, if this bit is cleared, and an mechanical presence switch toggles, the PCH still treats it as a proper mechanical presence switch event. NOTE: This bit is not reset on a Controller reset or by a Function Level Reset.
18	Hot Plug Capable Port (HPCP) — R/WO. 0 = Port is not capable of Hot-Plug. 1 = Port is Hot-Plug capable. This indicates whether the platform exposes this port to a device which can be Hot-Plugged. SATA by definition is hot-pluggable, but not all platforms are constructed to allow the device to be removed (it may be screwed into the chassis, for example). This bit can be used by system software to indicate a feature such as “eject device” to the end-user. The PCH takes no action on the state of this bit — it is for system software only. For example, if this bit is cleared, and a Hot-Plug event occurs, the PCH still treats it as a proper Hot-Plug event. NOTE: This bit is not reset on a Controller reset or by a Function Level Reset.
17:16	Reserved
15	Controller Running (CR) — RO. When this bit is set, the DMA engines for a port are running.
14	FIS Receive Running (FR) — RO. When set, the FIS Receive DMA engine for the port is running.
13	Mechanical Presence Switch State (MPSS) — RO. The MPSS bit reports the state of a mechanical presence switch attached to this port. If CAP.SMPS is set to 1 and the mechanical presence switch is closed then this bit is cleared to 0. If CAP.SMPS is set to 1 and the mechanical presence switch is open then this bit is set to 1. If CAP.SMPS is set to '0' then this bit is cleared to 0. Software should only use this bit if both CAP.SMPS and PxCMD.MPSP are set to 1.



Bit	Description
12:8	<p>Current Command Slot (CCS) — RO. Indicates the current command slot the PCH is processing. This field is valid when the ST bit is set in this register, and is constantly updated by the PCH. This field can be updated as soon as the PCH recognizes an active command slot, or at some point soon after when it begins processing the command.</p> <p>This field is used by software to determine the current command issue location of the PCH. In queued mode, software shall not use this field, as its value does not represent the current command being executed. Software shall only use PxCI and PxSACT when running queued commands.</p>
7:5	Reserved
4	<p>FIS Receive Enable (FRE) — R/W. When set, the PCH may post received FISes into the FIS receive area pointed to by PxFB (ABAR+108h/188h/208h/288h) and PxFBU (ABAR+10Ch/18Ch/20Ch/28Ch). When cleared, received FISes are not accepted by the PCH, except for the first D2H (device-to-host) register FIS after the initialization sequence.</p> <p>System software must not set this bit until PxFB (PxFBU) have been programmed with a valid pointer to the FIS receive area, and if software wishes to move the base, this bit must first be cleared, and software must wait for the FR bit (bit 14) in this register to be cleared.</p>
3	<p>Command List Override (CLO) — R/W. Setting this bit to 1 causes PxTFD.STS.BSY and PxTFD.STS.DRQ to be cleared to 0. This allows a software reset to be transmitted to the device regardless of whether the BSY and DRQ bits are still set in the PxTFD.STS register. The Controller sets this bit to 0 when PxTFD.STS.BSY and PxTFD.STS.DRQ have been cleared to 0. A write to this register with a value of 0 shall have no effect.</p> <p>This bit shall only be set to 1 immediately prior to setting the PxCMD.ST bit to 1 from a previous value of 0. Setting this bit to 1 at any other time is not supported and will result in indeterminate behavior. Software must wait for CLO to be cleared to 0 before setting PxCMD.ST to 1.</p>
2	Power On Device (POD) — RO. Cold presence detect not supported. Defaults to 1.
1	<p>Spin-Up Device (SUD) — R/W / RO</p> <p>This bit is R/W and defaults to 0 for systems that support staggered spin-up (R/W when CAP.SSS (ABAR+00h:bit 27) is 1). Bit is RO 1 for systems that do not support staggered spin-up (when CAP.SSS is 0).</p> <p>0 = No action. 1 = On an edge detect from 0 to 1, the PCH starts a COMRESET initialization sequence to the device.</p> <p>Clearing this bit to 0 does not cause any OOB signal to be sent on the interface. When this bit is cleared to 0 and PxSCTL.DET=0h, the Controller will enter listen mode.</p>
0	<p>Start (ST) — R/W. When set, the PCH may process the command list. When cleared, the PCH may not process the command list. Whenever this bit is changed from a 0 to a 1, the PCH starts processing the command list at entry 0. Whenever this bit is changed from a 1 to a 0, the PxCI register is cleared by the PCH upon the PCH putting the controller into an idle state.</p> <p>Refer to section 10.3 of the Serial ATA AHCI Specification for important restrictions on when ST can be set to 1 and cleared to 0.</p>



14.4.2.8 PxTFD—Port [5:0] Task File Data Register (D31:F2)

Address Offset: Port 0: ABAR + 120h Attribute: RO
 Port 1: ABAR + 1A0h
 Port 2: ABAR + 220h (if port available; see [Section 1.3](#))
 Port 3: ABAR + 2A0h (if port available; see [Section 1.3](#))
 Port 4: ABAR + 320h
 Port 5: ABAR + 3A0h
 Default Value: 0000007Fh Size: 32 bits

This is a 32-bit register that copies specific fields of the task file when FISes are received. The FISes that contain this information are: D2H Register FIS, PIO Setup FIS and Set Device Bits FIS

Bit	Description		
31:16	Reserved		
15:8	Error (ERR) — RO. Contains the latest copy of the task file error register.		
7:0	Status (STS) — RO. Contains the latest copy of the task file status register. Fields of note in this register that affect AHCI.		
	Bit Field Definition		
	7	BSY	Indicates the interface is busy
	6:4	N/A	Not applicable
	3	DRQ	Indicates a data transfer is requested
	2:1	N/A	Not applicable
0	ERR	Indicates an error during the transfer	

14.4.2.9 PxSIG—Port [5:0] Signature Register (D31:F2)

Address Offset: Port 0: ABAR + 124h Attribute: RO
 Port 1: ABAR + 1A4h
 Port 2: ABAR + 224h (if port available; see [Section 1.3](#))
 Port 3: ABAR + 2A4h (if port available; see [Section 1.3](#))
 Port 4: ABAR + 324h
 Port 5: ABAR + 3A4h
 Default Value: FFFFFFFFh Size: 32 bits

This is a 32-bit register which contains the initial signature of an attached device when the first D2H Register FIS is received from that device. It is updated once after a reset sequence.

Bit	Description	
31:0	Signature (SIG) — RO. Contains the signature received from a device on the first D2H register FIS. The bit order is as follows:	
	Bit Field	
	31:24	LBA High Register
	23:16	LBA Mid Register
	15:8	LBA Low Register
7:0	Sector Count Register	



14.4.2.10 PxSSTS—Port [5:0] Serial ATA Status Register (D31:F2)

Address Offset: Port 0: ABAR + 128h Attribute: RO
 Port 1: ABAR + 1A8h
 Port 2: ABAR + 228h (if port available; see [Section 1.3](#))
 Port 3: ABAR + 2A8h (if port available; see [Section 1.3](#))
 Port 4: ABAR + 328h
 Port 5: ABAR + 3A8h
 Default Value: 00000000h Size: 32 bits

This is a 32-bit register that conveys the current state of the interface and host. The PCH updates it continuously and asynchronously. When the PCH transmits a COMRESET to the device, this register is updated to its reset values.

Bit	Description										
31:12	Reserved										
11:8	<p>Interface Power Management (IPM) — RO. Indicates the current interface state:</p> <table border="1"> <thead> <tr> <th>Value</th> <th>Description</th> </tr> </thead> <tbody> <tr> <td>0h</td> <td>Device not present or communication not established</td> </tr> <tr> <td>1h</td> <td>Interface in active state</td> </tr> <tr> <td>2h</td> <td>Interface in PARTIAL power management state</td> </tr> <tr> <td>6h</td> <td>Interface in SLUMBER power management state</td> </tr> </tbody> </table> <p>All other values reserved.</p>	Value	Description	0h	Device not present or communication not established	1h	Interface in active state	2h	Interface in PARTIAL power management state	6h	Interface in SLUMBER power management state
Value	Description										
0h	Device not present or communication not established										
1h	Interface in active state										
2h	Interface in PARTIAL power management state										
6h	Interface in SLUMBER power management state										
7:4	<p>Current Interface Speed (SPD) — RO. Indicates the negotiated interface communication speed.</p> <table border="1"> <thead> <tr> <th>Value</th> <th>Description</th> </tr> </thead> <tbody> <tr> <td>0h</td> <td>Device not present or communication not established</td> </tr> <tr> <td>1h</td> <td>Generation 1 communication rate negotiated</td> </tr> <tr> <td>2h</td> <td>Generation 2 communication rate negotiated</td> </tr> <tr> <td>3h</td> <td>Generation 3 communication rate negotiated</td> </tr> </tbody> </table> <p>All other values reserved. The PCH supports Gen 1 communication rates (1.5 Gb/s), Gen 2 rates (3.0 Gb/s) and Gen 3 rates (6.0 Gb/s) (supported speeds are determined by SKU; see Section 1.3)</p>	Value	Description	0h	Device not present or communication not established	1h	Generation 1 communication rate negotiated	2h	Generation 2 communication rate negotiated	3h	Generation 3 communication rate negotiated
Value	Description										
0h	Device not present or communication not established										
1h	Generation 1 communication rate negotiated										
2h	Generation 2 communication rate negotiated										
3h	Generation 3 communication rate negotiated										
3:0	<p>Device Detection (DET) — RO. Indicates the interface device detection and Phy state:</p> <table border="1"> <thead> <tr> <th>Value</th> <th>Description</th> </tr> </thead> <tbody> <tr> <td>0h</td> <td>No device detected and Phy communication not established</td> </tr> <tr> <td>1h</td> <td>Device presence detected but Phy communication not established</td> </tr> <tr> <td>3h</td> <td>Device presence detected and Phy communication established</td> </tr> <tr> <td>4h</td> <td>Phy in offline mode as a result of the interface being disabled or running in a BIST loopback mode</td> </tr> </tbody> </table> <p>All other values reserved.</p>	Value	Description	0h	No device detected and Phy communication not established	1h	Device presence detected but Phy communication not established	3h	Device presence detected and Phy communication established	4h	Phy in offline mode as a result of the interface being disabled or running in a BIST loopback mode
Value	Description										
0h	No device detected and Phy communication not established										
1h	Device presence detected but Phy communication not established										
3h	Device presence detected and Phy communication established										
4h	Phy in offline mode as a result of the interface being disabled or running in a BIST loopback mode										



14.4.2.11 PxSCTL — Port [5:0] Serial ATA Control Register (D31:F2)

Address Offset: Port 0: ABAR + 12Ch Attribute: R/W, RO
 Port 1: ABAR + 1ACh
 Port 2: ABAR + 22Ch (if port available; see [Section 1.3](#))
 Port 3: ABAR + 2ACh (if port available; see [Section 1.3](#))
 Port 4: ABAR + 32Ch
 Port 5: ABAR + 3ACh
 Default Value: 00000004h Size: 32 bits

This is a 32-bit read-write register by which software controls SATA capabilities. Writes to the SControl register result in an action being taken by the PCH or the interface. Reads from the register return the last value written to it.

Bit	Description										
31:20	Reserved										
19:16	Port Multiplier Port (PMP) — R/W. This field is not used by AHCI										
15:12	Select Power Management (SPM) — R/W. This field is not used by AHCI										
11:8	<p>Interface Power Management Transitions Allowed (IPM) — R/W. Indicates which power states the PCH is allowed to transition to:</p> <table border="1"> <thead> <tr> <th>Value</th> <th>Description</th> </tr> </thead> <tbody> <tr> <td>0h</td> <td>No interface restrictions</td> </tr> <tr> <td>1h</td> <td>Transitions to the PARTIAL state disabled</td> </tr> <tr> <td>2h</td> <td>Transitions to the SLUMBER state disabled</td> </tr> <tr> <td>3h</td> <td>Transitions to both PARTIAL and SLUMBER states disabled</td> </tr> </tbody> </table> <p>All other values reserved</p>	Value	Description	0h	No interface restrictions	1h	Transitions to the PARTIAL state disabled	2h	Transitions to the SLUMBER state disabled	3h	Transitions to both PARTIAL and SLUMBER states disabled
Value	Description										
0h	No interface restrictions										
1h	Transitions to the PARTIAL state disabled										
2h	Transitions to the SLUMBER state disabled										
3h	Transitions to both PARTIAL and SLUMBER states disabled										
7:4	<p>Speed Allowed (SPD) — R/W. Indicates the highest allowable speed of the interface. This speed is limited by the CAP.ISS (ABAR+00h:bit 23:20) field.</p> <table border="1"> <thead> <tr> <th>Value</th> <th>Description</th> </tr> </thead> <tbody> <tr> <td>0h</td> <td>No speed negotiation restrictions</td> </tr> <tr> <td>1h</td> <td>Limit speed negotiation to Generation 1 communication rate</td> </tr> <tr> <td>2h</td> <td>Limit speed negotiation to Generation 2 communication rate</td> </tr> <tr> <td>3h</td> <td>Limit speed negotiation to Generation 3 communication rate</td> </tr> </tbody> </table> <p>The PCH Supports Gen 1 communication rates (1.5 Gb/s), Gen 2 rates (3.0 Gb/s) and Gen 3 rates (6.0 Gb/s) (supported speeds are determined by SKU; see Section 1.3)</p> <p>If software changes SPD after port has been enabled, software is required to perform a port reset using DET=1h. This field shall remain 1h until set to another value by software.</p>	Value	Description	0h	No speed negotiation restrictions	1h	Limit speed negotiation to Generation 1 communication rate	2h	Limit speed negotiation to Generation 2 communication rate	3h	Limit speed negotiation to Generation 3 communication rate
Value	Description										
0h	No speed negotiation restrictions										
1h	Limit speed negotiation to Generation 1 communication rate										
2h	Limit speed negotiation to Generation 2 communication rate										
3h	Limit speed negotiation to Generation 3 communication rate										

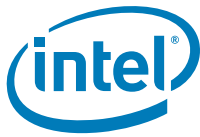

Bit	Description								
3:0	<p>Device Detection Initialization (DET) — R/W. Controls the PCH’s device detection and interface initialization.</p> <table border="1"> <thead> <tr> <th>Value</th> <th>Description</th> </tr> </thead> <tbody> <tr> <td>0h</td> <td>No device detection or initialization action requested</td> </tr> <tr> <td>1h</td> <td>Perform interface communication initialization sequence to establish communication. This is functionally equivalent to a hard reset and results in the interface being reset and communications re-initialized</td> </tr> <tr> <td>4h</td> <td>Disable the Serial ATA interface and put Phy in offline mode</td> </tr> </tbody> </table> <p>All other values reserved.</p> <p>When this field is written to a 1h, the PCH initiates COMRESET and starts the initialization process. When the initialization is complete, this field shall remain 1h until set to another value by software.</p> <p>This field may only be changed to 1h or 4h when PxCMD.ST is 0. Changing this field while the PCH is running results in undefined behavior.</p> <p>NOTE: It is permissible to implement any of the Serial ATA defined behaviors for transmission of COMRESET when DET=1h.</p>	Value	Description	0h	No device detection or initialization action requested	1h	Perform interface communication initialization sequence to establish communication. This is functionally equivalent to a hard reset and results in the interface being reset and communications re-initialized	4h	Disable the Serial ATA interface and put Phy in offline mode
Value	Description								
0h	No device detection or initialization action requested								
1h	Perform interface communication initialization sequence to establish communication. This is functionally equivalent to a hard reset and results in the interface being reset and communications re-initialized								
4h	Disable the Serial ATA interface and put Phy in offline mode								

14.4.2.12 PxSERR—Port [5:0] Serial ATA Error Register (D31:F2)

Address Offset: Port 0: ABAR + 130h Attribute: R/WC
 Port 1: ABAR + 1B0h
 Port 2: ABAR + 230h (if port available; see [Section 1.3](#))
 Port 3: ABAR + 2B0h (if port available; see [Section 1.3](#))
 Port 4: ABAR + 330h
 Port 5: ABAR + 3B0h

Default Value: 00000000h Size: 32 bits

Bits 26:16 of this register contain diagnostic error information for use by diagnostic software in validating correct operation or isolating failure modes. Bits 11:0 contain error information used by host software in determining the appropriate response to the error condition. If one or more of bits 11:8 of this register are set, the controller will stop the current transfer.

Bit	Description
31:27	Reserved
26	Exchanged (X) — R/WC. When set to 1, this bit indicates that a change in device presence has been detected since the last time this bit was cleared. This bit shall always be set to 1 anytime a COMINIT signal is received. This bit is reflected in the POIS.PCS bit.
25	Unrecognized FIS Type (F) — R/WC. Indicates that one or more FISs were received by the Transport layer with good CRC, but had a type field that was not recognized.
24	Transport state transition error (T) — R/WC. Indicates that an error has occurred in the transition from one state to another within the Transport layer since the last time this bit was cleared.
23	Link Sequence Error (S): Indicates that one or more Link state machine error conditions was encountered. The Link Layer state machine defines the conditions under which the link layer detects an erroneous transition.



Bit	Description
22	Handshake (H) — R/WC. Indicates that one or more R_ERR handshake response was received in response to frame transmission. Such errors may be the result of a CRC error detected by the recipient, a disparity or 8b/10b decoding error, or other error condition leading to a negative handshake on a transmitted frame.
21	CRC Error (C) — R/WC. Indicates that one or more CRC errors occurred with the Link Layer.
20	Disparity Error (D) — R/WC. This field is not used by AHCI.
19	10b to 8b Decode Error (B) — R/WC. Indicates that one or more 10b to 8b decoding errors occurred.
18	Comm Wake (W) — R/WC. Indicates that a Comm Wake signal was detected by the Phy.
17	Phy Internal Error (I) — R/WC. Indicates that the Phy detected some internal error.
16	PhyRdy Change (N) — R/WC. When set to 1, this bit indicates that the internal PhyRdy signal changed state since the last time this bit was cleared. In the PCH, this bit will be set when PhyRdy changes from a 0 -> 1 or a 1 -> 0. The state of this bit is then reflected in the PxIS.PRCs interrupt status bit and an interrupt will be generated if enabled. Software clears this bit by writing a 1 to it.
15:12	Reserved
11	Internal Error (E) — R/WC. The SATA controller failed due to a master or target abort when attempting to access system memory.
10	Protocol Error (P) — R/WC. A violation of the Serial ATA protocol was detected. NOTE: The PCH does not set this bit for all protocol violations that may occur on the SATA link.
9	Persistent Communication or Data Integrity Error (C) — R/WC. A communication error that was not recovered occurred that is expected to be persistent. Persistent communications errors may arise from faulty interconnect with the device, from a device that has been removed or has failed, or a number of other causes.
8	Transient Data Integrity Error (T) — R/WC. A data integrity error occurred that was not recovered by the interface.
7:2	Reserved
1	Recovered Communications Error (M) — R/WC. Communications between the device and host was temporarily lost but was re-established. This can arise from a device temporarily being removed, from a temporary loss of Phy synchronization, or from other causes and may be derived from the PhyNRdy signal between the Phy and Link layers.
0	Recovered Data Integrity Error (I) — R/WC. A data integrity error occurred that was recovered by the interface through a retry operation or other recovery action.

**14.4.2.13 PxSACT—Port [5:0] Serial ATA Active Register (D31:F2)**

Address Offset: Port 0: ABAR + 134h Attribute: R/W
 Port 1: ABAR + 1B4h
 Port 2: ABAR + 234h (if port available; see [Section 1.3](#))
 Port 3: ABAR + 2B4h (if port available; see [Section 1.3](#))
 Port 4: ABAR + 334h
 Port 5: ABAR + 3B4h
 Default Value: 00000000h Size: 32 bits

Bit	Description
31:0	Device Status (DS) — R/W. System software sets this bit for SATA queuing operations prior to setting the PxCI.CI bit in the same command slot entry. This field is cleared using the Set Device Bits FIS. This field is also cleared when PxCMD.ST (ABAR+118h/198h/218h/298h:bit 0) is cleared by software, and as a result of a COMRESET or SRST.

14.4.2.14 PxCI—Port [5:0] Command Issue Register (D31:F2)

Address Offset: Port 0: ABAR + 138h Attribute: R/W
 Port 1: ABAR + 1B8h
 Port 2: ABAR + 238h (if port available; see [Section 1.3](#))
 Port 3: ABAR + 2B8h (if port available; see [Section 1.3](#))
 Port 4: ABAR + 338h
 Port 5: ABAR + 3B8h
 Default Value: 00000000h Size: 32 bits

Bit	Description
31:0	Commands Issued (CI) — R/W. This field is set by software to indicate to the PCH that a command has been built-in system memory for a command slot and may be sent to the device. When the PCH receives a FIS which clears the BSY and DRQ bits for the command, it clears the corresponding bit in this register for that command slot. Bits in this field shall only be set to 1 by software when PxCMD.ST is set to 1. This field is also cleared when PxCMD.ST (ABAR+118h/198h/218h/298h:bit 0) is cleared by software.

§ §



15 SATA Controller Registers (D31:F5)

15.1 PCI Configuration Registers (SATA-D31:F5)

Note: Address locations that are not shown should be treated as Reserved.

All of the SATA registers are in the core well. None of the registers can be locked.

Table 15-1. SATA Controller PCI Register Address Map (SATA-D31:F5) (Sheet 1 of 2)

Offset	Mnemonic	Register Name	Default	Attribute
00h-01h	VID	Vendor Identification	8086h	RO
02h-03h	DID	Device Identification	See register description	RO
04h-05h	PCICMD	PCI Command	0000h	R/W, RO
06h-07h	PCISTS	PCI Status	02B0h	R/WC, RO
08h	RID	Revision Identification	See register description	RO
09h	PI	Programming Interface	See register description	See register description
0Ah	SCC	Sub Class Code	See register description	See register description
0Bh	BCC	Base Class Code	01h	RO
0Dh	PMLT	Primary Master Latency Timer	00h	RO
10h-13h	PCMD_BAR	Primary Command Block Base Address	00000001h	R/W, RO
14h-17h	PCNL_BAR	Primary Control Block Base Address	00000001h	R/W, RO
18h-1Bh	SCMD_BAR	Secondary Command Block Base Address	00000001h	R/W, RO
1Ch-1Fh	SCNL_BAR	Secondary Control Block Base Address	00000001h	R/W, RO
20h-23h	BAR	Legacy Bus Master Base Address	00000001h	R/W, RO
24h-27h	SIDPBA	Serial ATA Index / Data Pair Base Address	00000000h	See register description
2Ch-2Dh	SVID	Subsystem Vendor Identification	0000h	R/WO
2Eh-2Fh	SID	Subsystem Identification	0000h	R/WO
34h	CAP	Capabilities Pointer	80h	RO
3Ch	INT_LN	Interrupt Line	00h	R/W
3Dh	INT_PN	Interrupt Pin	See register description	RO
40h-41h	IDE_TIM	Primary IDE Timing Register	0000h	R/W
42h-43h	IDE_TIM	Secondary IDE Timing Registers	0000h	R/W

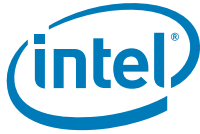

Table 15-1. SATA Controller PCI Register Address Map (SATA–D31:F5) (Sheet 2 of 2)

Offset	Mnemonic	Register Name	Default	Attribute
70h–71h	PID	PCI Power Management Capability ID	See register description	RO
72h–73h	PC	PCI Power Management Capabilities	4003h	RO
74h–75h	PMCS	PCI Power Management Control and Status	0008h	R/W, RO, R/WC
90h–91h	MAP	Address Map	0000h	R/W
92h–93h	PCS	Port Control and Status	0000h	R/W, RO, R/WC
A8h–ABh	SATACR0	SATA Capability Register 0	0010B012h	RO, R/WO
ACh–AFh	SATACR1	SATA Capability Register 1	00000048h	RO
B0h–B1h	FLRCID	FLR Capability ID	0009h	RO
B2h–B3h	FLRCLV	FLR Capability Length and Value	2006h	RO
B4h–B5h	FLRCTRL	FLR Control	0000h	R/W, RO
C0h	ATC	APM Trapping Control	00h	R/W
C4h	ATS	ATM Trapping Status	00h	R/WC

NOTE: The PCH SATA controller is not arbitrated as a PCI device; therefore, it does not need a master latency timer.

15.1.1 VID—Vendor Identification Register (SATA–D31:F5)

Offset Address:	00h–01h	Attribute:	RO
Default Value:	8086h	Size:	16 bit
Lockable:	No	Power Well:	Core

Bit	Description
15:0	Vendor ID — RO. This is a 16-bit value assigned to Intel. Intel VID = 8086h

15.1.2 DID—Device Identification Register (SATA–D31:F5)

Offset Address:	02h–03h	Attribute:	RO
Default Value:	See bit description	Size:	16 bit
Lockable:	No	Power Well:	Core

Bit	Description
15:0	Device ID — RO. This is a 16-bit value assigned to the PCH SATA controller. NOTE: The value of this field will change dependent upon the value of the MAP Register. See Section and Section 15.1.25



15.1.3 PCICMD—PCI Command Register (SATA–D31:F5)

Address Offset: 04h–05h
Default Value: 0000h

Attribute: RO, R/W
Size: 16 bits

Bit	Description
15:11	Reserved
10	Interrupt Disable — R/W. This disables pin-based INTx# interrupts. This bit has no effect on MSI operation. 0 = Internal INTx# messages are generated if there is an interrupt and MSI is not enabled. 1 = Internal INTx# messages will not be generated.
9	Fast Back to Back Enable (FBE) — RO. Hardwired to 0.
8	SERR# Enable (SERR_EN) — RO. Hardwired to 0.
7	Wait Cycle Control (WCC) — RO. Hardwired to 0.
6	Parity Error Response (PER) — R/W. 0 = Disabled. SATA controller will not generate PERR# when a data parity error is detected. 1 = Enabled. SATA controller will generate PERR# when a data parity error is detected.
5	VGA Palette Snoop (VPS) — RO. Hardwired to 0.
4	Postable Memory Write Enable (PMWE) — RO. Hardwired to 0.
3	Special Cycle Enable (SCE) — RO. Hardwired to 0.
2	Bus Master Enable (BME) — R/W. This bit controls the PCH ability to act as a PCI master for IDE Bus Master transfers. This bit does not impact the generation of completions for split transaction commands.
1	Memory Space Enable (MSE) — RO. This controller does not support AHCI; therefore, no memory space is required.
0	I/O Space Enable (IOSE) — R/W. This bit controls access to the I/O space registers. 0 = Disables access to the Legacy or Native IDE ports (both Primary and Secondary) as well as the Bus Master I/O registers. 1 = Enable. Note that the Base Address register for the Bus Master registers should be programmed before this bit is set.



15.1.4 PCISTS — PCI Status Register (SATA–D31:F5)

Address Offset: 06h–07h Attribute: R/WC, RO
 Default Value: 02B0h Size: 16 bits

Note: For the writable bits, software must write a 1 to clear bits that are set. Writing a 0 to the bit has no effect.

Bit	Description
15	Detected Parity Error (DPE) — R/WC. 0 = No parity error detected by SATA controller. 1 = SATA controller detects a parity error on its interface.
14	Signaled System Error (SSE) — RO. Hardwired to 0.
13	Received Master Abort (RMA) — R/WC. 0 = Master abort Not generated. 1 = SATA controller, as a master, generated a master abort.
12	Reserved
11	Signaled Target Abort (STA) — RO. Hardwired to 0.
10:9	DEVSEL# Timing Status (DEV_STS) — RO. 01 = Hardwired; Controls the device select time for the SATA controller’s PCI interface.
8	Data Parity Error Detected (DPED) — R/WC. For PCH, this bit can only be set on read completions received from SiBUS where there is a parity error. 1 = SATA controller, as a master, either detects a parity error or sees the parity error line asserted, and the parity error response bit (bit 6 of the command register) is set.
7	Fast Back to Back Capable (FB2BC) — RO. Hardwired to 1.
6	User Definable Features (UDF) — RO. Hardwired to 0.
5	66MHz Capable (66MHZ_CAP) — RO. Hardwired to 1.
4	Capabilities List (CAP_LIST) — RO. This bit indicates the presence of a capabilities list. The minimum requirement for the capabilities list must be PCI power management for the SATA controller.
3	Interrupt Status (INTS) — RO. Reflects the state of INTx# messages, IRQ14 or IRQ15. 0 = Interrupt is cleared (independent of the state of Interrupt Disable bit in the command register [offset 04h]). 1 = Interrupt is to be asserted
2:0	Reserved

15.1.5 RID—Revision Identification Register (SATA–D31:F5)

Offset Address: 08h Attribute: RO
 Default Value: See bit description Size: 8 bits

Bit	Description
7:0	Revision ID — RO. See the <i>Intel® 6 Series Chipset and Intel® C200 Series Chipset Specification Update</i> for the value of the RID Register.

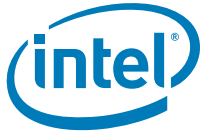

15.1.9 PMLT—Primary Master Latency Timer Register (SATA-D31:F5)

Address Offset: 0Dh Attribute: RO
Default Value: 00h Size: 8 bits

Bit	Description
7:0	Master Latency Timer Count (MLTC) — RO. 00h = Hardwired. The SATA controller is implemented internally, and is not arbitrated as a PCI device, so it does not need a Master Latency Timer.

15.1.10 PCMD_BAR—Primary Command Block Base Address Register (SATA-D31:F5)

Address Offset: 10h–13h Attribute: R/W, RO
Default Value: 00000001h Size: 32 bits

Bit	Description
31:16	Reserved
15:3	Base Address — R/W. This field provides the base address of the I/O space (8 consecutive I/O locations).
2:1	Reserved
0	Resource Type Indicator (RTE) — RO. Hardwired to 1 to indicate a request for I/O space.

NOTE: This 8-byte I/O space is used in native mode for the Primary Controller's Command Block.

15.1.11 PCNL_BAR—Primary Control Block Base Address Register (SATA-D31:F5)

Address Offset: 14h–17h Attribute: R/W, RO
Default Value: 00000001h Size: 32 bits

Bit	Description
31:16	Reserved
15:2	Base Address — R/W. This field provides the base address of the I/O space (4 consecutive I/O locations).
1	Reserved
0	Resource Type Indicator (RTE) — RO. Hardwired to 1 to indicate a request for I/O space.

NOTE: This 4-byte I/O space is used in native mode for the Primary Controller's Command Block.



15.1.12 SCMD_BAR—Secondary Command Block Base Address Register (SATA D31:F5)

Address Offset: 18h–1Bh Attribute: R/W, RO
 Default Value: 00000001h Size: 32 bits

Bit	Description
31:16	Reserved
15:3	Base Address — R/W. This field provides the base address of the I/O space (8 consecutive I/O locations).
2:1	Reserved
0	Resource Type Indicator (RTE) — RO. Hardwired to 1 to indicate a request for I/O space.

NOTE: This 8-byte I/O space is used in native mode for the Secondary Controller’s Command Block.

15.1.13 SCNL_BAR—Secondary Control Block Base Address Register (SATA D31:F5)

Address Offset: 1Ch–1Fh Attribute: R/W, RO
 Default Value: 00000001h Size: 32 bits

Bit	Description
31:16	Reserved
15:2	Base Address — R/W. This field provides the base address of the I/O space (4 consecutive I/O locations).
1	Reserved
0	Resource Type Indicator (RTE) — RO. Hardwired to 1 to indicate a request for I/O space.

NOTE: This 4-byte I/O space is used in native mode for the Secondary Controller’s Command Block.



15.1.14 BAR—Legacy Bus Master Base Address Register (SATA-D31:F5)

Address Offset: 20h–23h Attribute: R/W, RO
Default Value: 00000001h Size: 32 bits

The Bus Master IDE interface function uses Base Address register 5 to request a 16-byte I/O space to provide a software interface to the Bus Master functions. Only 12 bytes are actually used (6 bytes for primary, 6 bytes for secondary). Only bits [15:4] are used to decode the address.

Bit	Description
31:16	Reserved
15:5	Base Address — R/W. This field provides the base address of the I/O space (16 consecutive I/O locations).
4	Base Address 4 (BA4) — R/W. When SCC is 01h, this bit will be R/W resulting in requesting 16B of I/O space.
3:1	Reserved
0	Resource Type Indicator (RTE) — RO. Hardwired to 1 to indicate a request for I/O space.

15.1.15 SIDPBA—SATA Index/Data Pair Base Address Register (SATA-D31:F5)

Address Offset: 24h–27h Attribute: R/W, RO
Default Value: 00000000h Size: 32 bits

When SCC is 01h

When the programming interface is IDE, the register represents an I/O BAR allocating 16B of I/O space for the I/O mapped registers defined in [Section 15.3](#). Note that although 16B of locations are allocated, some maybe reserved.

Bit	Description
31:16	Reserved
15:4	Base Address (BA) — R/W. Base address of register I/O space
3:1	Reserved
0	Resource Type Indicator (RTE) — RO. Hardwired to 1 to indicate a request for I/O space.



15.1.16 SVID—Subsystem Vendor Identification Register (SATA–D31:F5)

Address Offset: 2Ch–2Dh Attribute: R/WO
 Default Value: 0000h Size: 16 bits
 Lockable: No Power Well: Core
 Function Level Reset: No

Bit	Description
15:0	Subsystem Vendor ID (SVID) — R/WO. Value is written by BIOS. No hardware action taken on this value.

15.1.17 SID—Subsystem Identification Register (SATA–D31:F5)

Address Offset: 2Eh–2Fh Attribute: R/WO
 Default Value: 0000h Size: 16 bits
 Lockable: No Power Well: Core

Bit	Description
15:0	Subsystem ID (SID) — R/WO. Value is written by BIOS. No hardware action taken on this value.

15.1.18 CAP—Capabilities Pointer Register (SATA–D31:F5)

Address Offset: 34h Attribute: RO
 Default Value: 70h Size: 8 bits

Bit	Description
7:0	Capabilities Pointer (CAP_PTR) — RO. Indicates that the first capability pointer offset is 70h if the Sub Class Code (SCC) (Dev 31:F2:0Ah) is configured as IDE mode (value of 01).

15.1.19 INT_LN—Interrupt Line Register (SATA–D31:F5)

Address Offset: 3Ch Attribute: R/W
 Default Value: 00h Size: 8 bits
 Function Level Reset: No

Bit	Description
7:0	Interrupt Line — R/W. This field is used to communicate to software the interrupt line that the interrupt pin is connected to. These bits are not reset by FLR.

15.1.20 INT_PN—Interrupt Pin Register (SATA–D31:F5)

Address Offset: 3Dh Attribute: RO
 Default Value: See Register Description Size: 8 bits

Bit	Description
7:0	Interrupt Pin — RO. This reflects the value of D31IP.SIP1 (Chipset Config Registers:Offset 3100h:bits 11:8).



15.1.21 IDE_TIM—IDE Timing Register (SATA–D31:F5)

Address Offset: Primary: 40h–41h Attribute: R/W
 Secondary: 42h–43h
 Default Value: 0000h Size: 16 bits

Bit	Description
15	<p>IDE Decode Enable (IDE) — R/W. Individually enable/disable the Primary or Secondary decode. 0 = Disable. 1 = Enables the PCH to decode the associated Command Blocks (1F0–1F7h for primary, 170–177h for secondary) and Control Block (3F6h for primary and 376h for secondary). This bit effects the IDE decode ranges for both legacy and native-Mode decoding.</p> <p>NOTE: This bit affects SATA operation in both combined and non-combined ATA modes. See Section 5.16 for more on ATA modes of operation.</p>
14:0	Reserved

15.1.22 PID—PCI Power Management Capability Identification Register (SATA–D31:F5)

Address Offset: 70h–71h Attribute: RO
 Default Value: B001h Size: 16 bits

Bits	Description
15:8	Next Capability (NEXT) — RO. When SCC is 01h, this field will be B0h indicating the next item is FLR Capability Pointer in the list.
7:0	Capability ID (CID) — RO. Indicates that this pointer is a PCI power management.

15.1.23 PC—PCI Power Management Capabilities Register (SATA–D31:F5)

Address Offset: 72h–73h Attribute: RO
 Default Value: 4003h Size: 16 bits

Bits	Description
15:11	PME Support (PME_SUP) — RO. By default with SCC = 01h, the default value of 00000 indicates no PME support in IDE mode.
10	D2 Support (D2_SUP) — RO. Hardwired to 0. The D2 state is not supported
9	D1 Support (D1_SUP) — RO. Hardwired to 0. The D1 state is not supported
8:6	Auxiliary Current (AUX_CUR) — RO. PME# from D3 _{COLD} state is not supported, therefore this field is 000b.
5	Device Specific Initialization (DSI) — RO. Hardwired to 0 to indicate that no device-specific initialization is required.
4	Reserved
3	PME Clock (PME_CLK) — RO. Hardwired to 0 to indicate that PCI clock is not required to generate PME#.
2:0	Version (VER) — RO. Hardwired to 011 to indicates support for Revision 1.2 of the PCI Power Management Specification.



15.1.24 PMCS—PCI Power Management Control and Status Register (SATA–D31:F5)

Address Offset: 74h–75h Attribute: RO, R/W, R/WC
 Default Value: 0008h Size: 16 bits
 Function Level Reset: No (Bits 8 and 15 only)

Bits	Description
15	<p>PME Status (PMES) — R/WC. Bit is set when a PME event is to be requested, and if this bit and PMEE is set, a PME# will be generated from the SATA controller.</p> <p>NOTE: When SCC=01h this bit will be RO 0. Software is advised to clear PMEE together with PMES prior to changing SCC through MAP.SMS.</p> <p>This bit is not reset by Function Level Reset.</p>
14:9	Reserved
8	<p>PME Enable (PMEE) — R/W. When SCC is not 01h, this bit R/W. When set, the SATA controller generates PME# form D3_{HOT} on a wake event.</p> <p>Note: When SCC=01h this bit will be RO 0. Software is advised to clear PMEE together with PMES prior to changing SCC through MAP.SMS.</p> <p>This bit is not reset by Function Level Reset.</p>
7:4	Reserved
3	<p>No Soft Reset (NSFRST) — RO. These bits are used to indicate whether devices transitioning from D3_{HOT} state to D0 state will perform an internal reset.</p> <p>0 = Device transitioning from D3_{HOT} state to D0 state perform an internal reset. 1 = Device transitioning from D3_{HOT} state to D0 state do not perform an internal reset.</p> <p>Configuration content is preserved. Upon transition from the D3_{HOT} state to D0 state initialized state, no additional operating system intervention is required to preserve configuration context beyond writing to the PowerState bits.</p> <p>Regardless of this bit, the controller transition from D3_{HOT} state to D0 state by a system or bus segment reset will return to the state D0 uninitialized with only PME context preserved if PME is supported and enabled.</p>
2	Reserved
1:0	<p>Power State (PS) — R/W. These bits are used both to determine the current power state of the SATA controller and to set a new power state.</p> <p>00 = D0 state 11 = D3_{HOT} state</p> <p>When in the D3_{HOT} state, the controller's configuration space is available, but the I/O and memory spaces are not. Additionally, interrupts are blocked.</p>



15.1.25 MAP—Address Map Register (SATA–D31:F5)

Address Offset: 90h–91h Attribute: R/W, R/WO, RO
Default Value: 0000h Size: bits
Function Level Reset: No (Bits 9:8 only)

Bits	Description
15:8	Reserved
7:6	SATA Mode Select (SMS) — R/W. Software programs these bits to control the mode in which the SATA Controller should operate. 00b = IDE Mode All other combinations are reserved.
5:2	Reserved
1:0	Map Value (MV) — Reserved



15.1.26 PCS—Port Control and Status Register (SATA–D31:F5)

Address Offset:	92h–93h	Attribute:	R/W, RO
Default Value:	0000h	Size:	16 bits
Function Level Reset:	No		

By default, the SATA ports are set to the disabled state (bits [5:0] = 0). When enabled by software, the ports can transition between the on, partial, and slumber states and can detect devices. When disabled, the port is in the “off” state and cannot detect any devices.

If an AHCI-aware or RAID enabled operating system is being booted then system BIOS shall insure that all supported SATA ports are enabled prior to passing control to the OS. Once the AHCI aware OS is booted it becomes the enabling/disabling policy owner for the individual SATA ports. This is accomplished by manipulating a port’s PxSCTL and PxCMD fields. Because an AHCI or RAID aware OS will typically not have knowledge of the PxE bits and because the PxE bits act as master on/off switches for the ports, pre-boot software must insure that these bits are set to 1 prior to booting the OS, regardless as to whether or not a device is currently on the port.

Bits	Description
15:10	Reserved
9	Port 5 Present (P5P) — RO. The status of this bit may change at any time. This bit is cleared when the port is disabled using P1E. This bit is not cleared upon surprise removal of a device. 0 = No device detected. 1 = The presence of a device on Port 1 has been detected.
8	Port 4 Present (P4P) — RO. The status of this bit may change at any time. This bit is cleared when the port is disabled using P0E. This bit is not cleared upon surprise removal of a device. 0 = No device detected. 1 = The presence of a device on Port 0 has been detected.
7:2	Reserved
1	Port 5 Enabled (P5E) — R/W. 0 = Disabled. The port is in the ‘off’ state and cannot detect any devices. 1 = Enabled. The port can transition between the on, partial, and slumber states and can detect devices. This bit is read-only 0 when MAP.SPD[1]= 1.
0	Port 4 Enabled (P4E) — R/W. 0 = Disabled. The port is in the ‘off’ state and cannot detect any devices. 1 = Enabled. The port can transition between the on, partial, and slumber states and can detect devices. This bit is read-only 0 when MAP.SPD[0]= 1.



15.1.27 SATACR0— SATA Capability Register 0 (SATA–D31:F5)

Address Offset: A8h–ABh Attribute: RO, R/WO
 Default Value: 0010B012h Size: 32 bits
 Function Level Reset: No (Bits 15:8 only)

Note: When SCC is 01h this register is read-only 0.

Bit	Description
31:24	Reserved
23:20	Major Revision (MAJREV) — RO. Major revision number of the SATA Capability Pointer implemented.
19:16	Minor Revision (MINREV) — RO. Minor revision number of the SATA Capability Pointer implemented.
15:8	Next Capability Pointer (NEXT) — R/WO. Points to the next capability structure.
7:0	Capability ID (CAP) — RO. The value of 12h has been assigned by the PCI SIG to designate the SATA capability pointer.

15.1.28 SATACR1— SATA Capability Register 1 (SATA–D31:F5)

Address Offset: ACh–AFh Attribute: RO
 Default Value: 00000048h Size: 32 bits

When SCC is 01h this register is read-only 0.

Bit	Description
31:16	Reserved
15:4	BAR Offset (BAROFST) — RO. Indicates the offset into the BAR where the index/Data pair are located (in DWord granularity). The index and Data I/O registers are located at offset 10h within the I/O space defined by LBAR (BAR4). A value of 004h indicates offset 10h.
3:0	BAR Location (BARLOC) — RO. Indicates the absolute PCI Configuration Register address of the BAR containing the Index/Data pair (in DWord granularity). The Index and Data I/O registers reside within the space defined by LBAR (BAR4) in the SATA controller. a value of 8h indicates and offset of 20h, which is LBAR (BAR4).

15.1.29 FLRCID— FLR Capability ID Register (SATA–D31:F5)

Address Offset: B0h–B1h Attribute: RO
 Default Value: 0009h Size: 16 bits

Bit	Description
15:8	Next Capability Pointer — RO. A value of 00h indicates the final item in the Capability List.
7:0	Capability ID — RO. The value of this field depends on the FLRCSSEL bit. If FLRCSSEL = 0, this field is 13h If FLRCSSEL = 1, this field is 09h, indicating vendor specific capability.



15.1.30 FLRCLV— FLR Capability Length and Value Register (SATA–D31:F5)

Address Offset: B2h–B3h Attribute: RO, R/WO
 Default Value: 2006h Size: 16 bits
 Function Level Reset: No (Bits 9:8 only)

When FLRCSSEL = 0, this register is defined as follows:

Bit	Description
15:10	Reserved
9	FLR Capability — R/WO. This field indicates support for Function Level Reset.
8	TXP Capability — R/WO. This field indicates support for the Transactions Pending (TXP) bit. TXP must be supported if FLR is supported.
7:0	Capability Length — RO. This field indicates the number of bytes of the Vendor Specific capability as required by the PCI specification. It has the value of 06h for FLR Capability.

When FLRCSSEL = 1, this register is defined as follows:

Bit	Description
15:12	Vendor Specific Capability ID — RO. A value of 02h identifies this capability as a Function Level Reset.
11:8	Capability Version — RO. This field indicates the version of the FLR capability.
7:0	Capability Length — RO. This field indicates the number of bytes of the Vendor Specific capability as required by the PCI specification. It has the value of 06h for FLR Capability.

15.1.31 FLRCTRL— FLR Control Register (SATA–D31:F5)

Address Offset: B4h–B5h Attribute: R/W, RO
 Default Value: 0000h Size: 16 bits

Bit	Description
15:9	Reserved
8	Transactions Pending (TXP) — RO. 0 = Completions for all Non-Posted requests have been received by the controller. 1 = Controller has issued Non-Posted request which has not been completed.
7:1	Reserved
0	Initiate FLR — R/W. Used to initiate FLR transition. A write of 1 indicates FLR transition.



15.2 Bus Master IDE I/O Registers (D31:F5)

The bus master IDE function uses 16 bytes of I/O space, allocated using the BAR register, located in Device 31:Function 2 Configuration space, offset 20h. All bus master IDE I/O space registers can be accessed as byte, word, or DWord quantities. Reading reserved bits returns an indeterminate, inconsistent value, and writes to reserved bits have no effect (but should not be attempted). These registers are only used for legacy operation. Software must not use these registers when running AHCI. The description of the I/O registers is shown in [Table 15-2](#).

Table 15-2. Bus Master IDE I/O Register Address Map

BAR+ Offset	Mnemonic	Register	Default	Attribute
00	BMICP	Command Register Primary	00h	R/W
01	—	Reserved	—	RO
02	BMISP	Bus Master IDE Status Register Primary	00h	R/W, R/WC, RO
03	—	Reserved	—	RO
04–07	BMIDP	Bus Master IDE Descriptor Table Pointer Primary	xxxxxxxxh	R/W
08	BMICS	Command Register Secondary	00h	R/W
09	—	Reserved	—	RO
0Ah	BMISS	Bus Master IDE Status Register Secondary	00h	R/W, R/WC, RO
0Bh	—	Reserved	—	RO
0Ch–0Fh	BMIDS	Bus Master IDE Descriptor Table Pointer Secondary	xxxxxxxxh	R/W

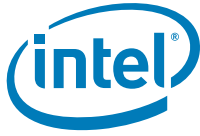

15.2.1 BMIC[P,S]—Bus Master IDE Command Register (D31:F5)

Address Offset: Primary: BAR + 00h Attribute: R/W
 Secondary: BAR + 08h
 Default Value: 00h Size: 8 bits

Bit	Description
7:4	Reserved
3	Read / Write Control (R/WC) — R/W. This bit sets the direction of the bus master transfer: This bit must NOT be changed when the bus master function is active. 0 = Memory reads 1 = Memory writes
2:1	Reserved
0	Start/Stop Bus Master (START) — R/W. 0 = All state information is lost when this bit is cleared. Master mode operation cannot be stopped and then resumed. If this bit is reset while bus master operation is still active (that is, the Bus Master IDE Active bit (D31:F5:BAR + 02h, bit 0) of the Bus Master IDE Status register for that IDE channel is set) and the drive has not yet finished its data transfer (the Interrupt bit in the Bus Master IDE Status register for that IDE channel is not set), the bus master command is said to be aborted and data transferred from the drive may be discarded instead of being written to system memory. 1 = Enables bus master operation of the controller. Bus master operation does not actually start unless the Bus Master Enable bit (D31:F5:04h, bit 2) in PCI configuration space is also set. Bus master operation begins when this bit is detected changing from 0 to 1. The controller will transfer data between the IDE device and memory only when this bit is set. Master operation can be halted by writing a 0 to this bit. NOTE: This bit is intended to be cleared by software after the data transfer is completed, as indicated by either the Bus Master IDE Active bit being cleared or the Interrupt bit of the Bus Master IDE Status register for that IDE channel being set, or both. Hardware does not clear this bit automatically. If this bit is cleared to 0 prior to the DMA data transfer being initiated by the drive in a device to memory data transfer, then the PCH will not send DMAT to terminate the data transfer. SW intervention (such as, sending SRST) is required to reset the interface in this condition.



15.2.2 BMIS[P,S]—Bus Master IDE Status Register (D31:F5)

Address Offset: Primary: BAR + 02h Attribute: R/W, R/WC, RO
 Secondary: BAR + 0Ah
 Default Value: 00h Size: 8 bits

Bit	Description
7	PRD Interrupt Status (PRDIS) — R/WC. 0 = Software clears this bit by writing a 1 to it. 1 = This bit is set when the host controller execution of a PRD that has its PRD_INT bit set.
6	Reserved
5	Drive 0 DMA Capable — R/W. 0 = Not Capable 1 = Capable. Set by device dependent code (BIOS or device driver) to indicate that drive 0 for this channel is capable of DMA transfers, and that the controller has been initialized for optimum performance. The PCH does not use this bit. It is intended for systems that do not attach BMIDE to the PCI bus.
4:3	Reserved
2	Interrupt — R/WC. 0 = Software clears this bit by writing a 1 to it. 1 = Set when a device FIS is received with the 'I' bit set, provided that software has not disabled interrupts using the IEN bit of the Device Control Register (see chapter 5 of the <i>Serial ATA Specification</i> , Revision 1.0a).
1	Error — R/WC. 0 = Software clears this bit by writing a 1 to it. 1 = This bit is set when the controller encounters a target abort or master abort when transferring data on PCI.
0	Bus Master IDE Active (ACT) — RO. 0 = This bit is cleared by the PCH when the last transfer for a region is performed, where EOT for that region is set in the region descriptor. It is also cleared by the PCH when the Start Bus Master bit (D31:F5:BAR+ 00h, bit 0) is cleared in the Command register. When this bit is read as a 0, all data transferred from the drive during the previous bus master command is visible in system memory, unless the bus master command was aborted. 1 = Set by the PCH when the Start bit is written to the Command register.

15.2.3 BMID[P,S]—Bus Master IDE Descriptor Table Pointer Register (D31:F5)

Address Offset: Primary: BAR + 04h–07h Attribute: R/W
 Secondary: BAR + 0Ch–0Fh
 Default Value: All bits undefined Size: 32 bits

Bit	Description
31:2	Address of Descriptor Table (ADDR) — R/W. The bits in this field correspond to bits [31:2] of the memory location of the Physical Region Descriptor (PRD). The Descriptor Table must be DWord-aligned. The Descriptor Table must not cross a 64-K boundary in memory.
1:0	Reserved



15.3 Serial ATA Index/Data Pair Superset Registers

All of these I/O registers are in the core well. They are exposed only when SCC is 01h (that is, IDE programming interface) and the controller is not in combined mode. These are Index/Data Pair registers that are used to access the SerialATA superset registers (SerialATA Status, SerialATA Control and SerialATA Error). The I/O space for these registers is allocated through SIDPBA. Locations with offset from 08h to 0Fh are reserved for future expansion. Software-write operations to the reserved locations shall have no effect while software-read operations to the reserved locations shall return 0.

15.3.1 SINDX—SATA Index Register (D31:F5)

Address Offset: SIDPBA + 00h Attribute: R/W
 Default Value: 00000000h Size: 32 bits

Note: These are Index/Data Pair Registers that are used to access the SSTS, SCTL, and SERR. The I/O space for these registers is allocated through SIDPBA.

Bit	Description
31:16	Reserved
15:8	Port Index (PIDX) — R/W. This Index field is used to specify the port of the SATA controller at which the port-specific SSTS, SCTL, and SERR registers are located. 00h = Primary Master (Port 4) 02h = Secondary Master (Port 5) All other values are Reserved.
7:0	Register Index (RIDX) — R/W. This Index field is used to specify one out of three registers currently being indexed into. 00h = SSTS 01h = SCTL 02h = SERR All other values are Reserved

15.3.2 SDATA—SATA Index Data Register (D31:F5)

Address Offset: SIDPBA + 04h Attribute: R/W
 Default Value: All bits undefined Size: 32 bits

Note: These are Index/Data Pair Registers that are used to access the SSTS, SCTL, and SERR. The I/O space for these registers is allocated through SIDPBA.

Bit	Description
31:0	Data (DATA) — R/W. This Data register is a “window” through which data is read or written to the memory mapped registers. A read or write to this Data register triggers a corresponding read or write to the memory mapped register pointed to by the Index register. The Index register must be setup prior to the read or write to this Data register. Note that a physical register is not actually implemented as the data is actually stored in the memory mapped registers. Since this is not a physical register, the “default” value is the same as the default value of the register pointed to by Index.



15.3.2.1 PxSSTS—Serial ATA Status Register (D31:F5)

Address Offset: Attribute: RO
 Default Value: 00000000h Size: 32 bits

SDATA when SINDX.RIDX is 00h. This is a 32-bit register that conveys the current state of the interface and host. The PCH updates it continuously and asynchronously. When the PCH transmits a COMRESET to the device, this register is updated to its reset values.

Bit	Description										
31:12	Reserved										
11:8	<p>Interface Power Management (IPM) — RO. Indicates the current interface state:</p> <table border="1"> <thead> <tr> <th>Value</th> <th>Description</th> </tr> </thead> <tbody> <tr> <td>0h</td> <td>Device not present or communication not established</td> </tr> <tr> <td>1h</td> <td>Interface in active state</td> </tr> <tr> <td>2h</td> <td>Interface in PARTIAL power management state</td> </tr> <tr> <td>6h</td> <td>Interface in SLUMBER power management state</td> </tr> </tbody> </table> <p>All other values reserved.</p>	Value	Description	0h	Device not present or communication not established	1h	Interface in active state	2h	Interface in PARTIAL power management state	6h	Interface in SLUMBER power management state
Value	Description										
0h	Device not present or communication not established										
1h	Interface in active state										
2h	Interface in PARTIAL power management state										
6h	Interface in SLUMBER power management state										
7:4	<p>Current Interface Speed (SPD) — RO. Indicates the negotiated interface communication speed.</p> <table border="1"> <thead> <tr> <th>Value</th> <th>Description</th> </tr> </thead> <tbody> <tr> <td>0h</td> <td>Device not present or communication not established</td> </tr> <tr> <td>1h</td> <td>Generation 1 communication rate negotiated</td> </tr> <tr> <td>2h</td> <td>Generation 2 communication rate negotiated</td> </tr> </tbody> </table> <p>All other values reserved.</p> <p>The PCH Supports Gen 1 communication rates (1.5 Gb/s), Gen 2 rates (3.0 Gb/s)</p>	Value	Description	0h	Device not present or communication not established	1h	Generation 1 communication rate negotiated	2h	Generation 2 communication rate negotiated		
Value	Description										
0h	Device not present or communication not established										
1h	Generation 1 communication rate negotiated										
2h	Generation 2 communication rate negotiated										
3:0	<p>Device Detection (DET) — RO. Indicates the interface device detection and Phy state:</p> <table border="1"> <thead> <tr> <th>Value</th> <th>Description</th> </tr> </thead> <tbody> <tr> <td>0h</td> <td>No device detected and Phy communication not established</td> </tr> <tr> <td>1h</td> <td>Device presence detected but Phy communication not established</td> </tr> <tr> <td>3h</td> <td>Device presence detected and Phy communication established</td> </tr> <tr> <td>4h</td> <td>Phy in offline mode as a result of the interface being disabled or running in a BIST loopback mode</td> </tr> </tbody> </table> <p>All other values reserved.</p>	Value	Description	0h	No device detected and Phy communication not established	1h	Device presence detected but Phy communication not established	3h	Device presence detected and Phy communication established	4h	Phy in offline mode as a result of the interface being disabled or running in a BIST loopback mode
Value	Description										
0h	No device detected and Phy communication not established										
1h	Device presence detected but Phy communication not established										
3h	Device presence detected and Phy communication established										
4h	Phy in offline mode as a result of the interface being disabled or running in a BIST loopback mode										



15.3.2.3 PxSERR—Serial ATA Error Register (D31:F5)

Address Offset: Attribute: R/WC
 Default Value: 00000000h Size: 32 bits

SDATA when SINDx.RIDX is 02h.

Bits 26:16 of this register contains diagnostic error information for use by diagnostic software in validating correct operation or isolating failure modes. Bits 11:0 contain error information used by host software in determining the appropriate response to the error condition. If one or more of bits 11:8 of this register are set, the controller will stop the current transfer.

Bit	Description
31:27	Reserved
26	Exchanged (X) — R/WC. When set to 1, this bit indicates that a change in device presence has been detected since the last time this bit was cleared. This bit shall always be set to 1 anytime a COMINIT signal is received. This bit is reflected in the POIS.PCS bit.
25	Unrecognized FIS Type (F) — R/WC. Indicates that one or more FISs were received by the Transport layer with good CRC, but had a type field that was not recognized.
24	Transport state transition error (T) — R/WC. Indicates that an error has occurred in the transition from one state to another within the Transport layer since the last time this bit was cleared.
23	Link Sequence Error (S) — R/WC. Indicates that one or more Link state machine error conditions was encountered. The Link Layer state machine defines the conditions under which the link layer detects an erroneous transition.
22	Handshake (H) — R/WC. Indicates that one or more R_ERR handshake response was received in response to frame transmission. Such errors may be the result of a CRC error detected by the recipient, a disparity or 8b/10b decoding error, or other error condition leading to a negative handshake on a transmitted frame.
21	CRC Error (C) — R/WC. Indicates that one or more CRC errors occurred with the Link Layer.
20	Disparity Error (D) — R/WC. This field is not used by AHCI.
19	10b to 8b Decode Error (B) — R/WC. Indicates that one or more 10b to 8b decoding errors occurred.
18	Comm Wake (W) — R/WC. Indicates that a Comm Wake signal was detected by the Phy.
17	Phy Internal Error (I) — R/WC. Indicates that the Phy detected some internal error.
16	PhyRdy Change (N) — R/WC. When set to 1, this bit indicates that the internal PhyRdy signal changed state since the last time this bit was cleared. In the PCH, this bit will be set when PhyRdy changes from a 0 -> 1 or a 1 -> 0. The state of this bit is then reflected in the PxIS.PRCs interrupt status bit and an interrupt will be generated if enabled. Software clears this bit by writing a 1 to it.
15:12	Reserved
11	Internal Error (E) — R/WC. The SATA controller failed due to a master or target abort when attempting to access system memory.
10	Protocol Error (P) — R/WC. A violation of the Serial ATA protocol was detected. NOTE: The PCH does not set this bit for all protocol violations that may occur on the SATA link.

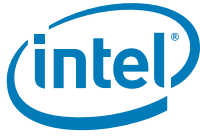

Bit	Description
9	Persistent Communication or Data Integrity Error (C) — R/WC. A communication error that was not recovered occurred that is expected to be persistent. Persistent communications errors may arise from faulty interconnect with the device, from a device that has been removed or has failed, or a number of other causes.
8	Transient Data Integrity Error (T) — R/WC. A data integrity error occurred that was not recovered by the interface.
7:2	Reserved
1	Recovered Communications Error (M) — R/WC. Communications between the device and host was temporarily lost but was re-established. This can arise from a device temporarily being removed, from a temporary loss of Phy synchronization, or from other causes and may be derived from the PhyNRdy signal between the Phy and Link layers.
0	Recovered Data Integrity Error (I) — R/WC. A data integrity error occurred that was recovered by the interface through a retry operation or other recovery action.

§ §



16 EHCI Controller Registers (D29:F0, D26:F0)

16.1 USB EHCI Configuration Registers (USB EHCI—D29:F0, D26:F0)

Note: Prior to BIOS initialization of the PCH USB subsystem, the EHCI controllers will appear as Function 7. After BIOS initialization, the EHCI controllers will be Function 0.

Note: Register address locations that are not shown in [Table 16-1](#) should be treated as Reserved (see [Section 9.2](#) for details).

Table 16-1. USB EHCI PCI Register Address Map (USB EHCI—D29:F0, D26:F0) (Sheet 1 of 2)

Offset M	nemonic	Register Name	Default Value	Attribute
00h–01h	VID	Vendor Identification	8086h	RO
02h–03h	DID	Device Identification	See register description	RO
04h–05h	PCICMD	PCI Command	0000h	R/W, RO
06h–07h	PCISTS	PCI Status	0290h	R/WC, RO
08h	RID	Revision Identification	See register description	RO
09h	PI	Programming Interface	20h	RO
0Ah	SCC	Sub Class Code	03h	RO
0Bh	BCC	Base Class Code	0Ch	RO
0Dh	PMLT	Primary Master Latency Timer	00h	RO
0Eh	HEADTYP	Header Type	80h	RO
10h–13h	MEM_BASE	Memory Base Address	00000000h	R/W, RO
2Ch–2Dh	SVID	USB EHCI Subsystem Vendor Identification	XXXXh	R/W
2Eh–2Fh	SID	USB EHCI Subsystem Identification	XXXXh	R/W
34h	CAP_PTR	Capabilities Pointer	50h	RO
3Ch	INT_LN	Interrupt Line	00h	R/W
3Dh	INT_PN	Interrupt Pin	See register description	RO
50h	PWR_CAPID	PCI Power Management Capability ID	01h	RO
51h	NXT_PTR1	Next Item Pointer	58h	R/W
52h–53h	PWR_CAP	Power Management Capabilities	C9C2h	R/W
54h–55h	PWR_CNTL_STS	Power Management Control/Status	0000h	R/W, R/WC, RO
58h	DEBUG_CAPID	Debug Port Capability ID	0Ah	RO



Table 16-1. USB EHCI PCI Register Address Map (USB EHCI—D29:F0, D26:F0) (Sheet 2 of 2)

Offset	Mnemonic	Register Name	Default Value	Attribute
59h	NXT_PTR2	Next Item Pointer #2	98h	RO
5Ah–5Bh	DEBUG_BASE	Debug Port Base Offset	20A0h	RO
60h	USB_RELNUM	USB Release Number	20h	RO
61h	FL_ADJ	Frame Length Adjustment	20h	R/W
62h–63h	PWAKE_CAP	Port Wake Capabilities	01FFh	R/W
64h–67h	—	Reserved	—	—
68h–6Bh	LEG_EXT_CAP	USB EHCI Legacy Support Extended Capability	00000001h	R/W, RO
6Ch–6Fh	LEG_EXT_CS	USB EHCI Legacy Extended Support Control/Status	00000000h	R/W, R/WC, RO
70h–73h	SPECIAL_SMI	Intel Specific USB 2.0 SMI	00000000h	R/W, R/WC
74h–7Fh	—	Reserved	—	—
80h	ACCESS_CNTL	Access Control	00h	R/W
84h–87h	EHCIIR1	EHCI Initialization Register 1	83088E01h	R/W
88h–8Bh	EHCIIR2	EHCI Initialization Register 2	04000010h	R/W
98h	FLR_CID	FLR Capability ID	09h	RO
99h	FLR_NEXT	FLR Next Capability Pointer	00h	RO
9Ah–9Bh	FLR_CLV	FLR Capability Length and Version	2006h	RO, R/WO
9Ch	FLR_CTRL	FLR Control	00h	R/W
9Dh	FLR_STAT	FLR Status	00h	RO
F4h–F7h	EHCIIR3	EHCI Initialization Register 3	00408588h	R/W
FCh–FFh	EHCIIR4	EHCI Initialization Register 4	20591708h	R/W

Note: All configuration registers in this section are in the core well and reset by a core well reset and the D3-to-D0 warm reset, except as noted.

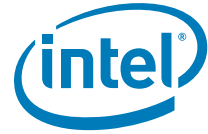

16.1.1 VID—Vendor Identification Register (USB EHCI—D29:F0, D26:F0)

Offset Address: 00h–01h Attribute: RO
 Default Value: 8086h Size: 16 bits

Bit	Description
15:0	Vendor ID — RO. This is a 16-bit value assigned to Intel.

16.1.2 DID—Device Identification Register (USB EHCI—D29:F0, D26:F0)

Offset Address: 02h–03h Attribute: RO
 Default Value: See bit description Size: 16 bits

Bit	Description
15:0	Device ID — RO. This is a 16-bit value assigned to the PCH USB EHCI controller. See the <i>Intel® 6 Series Chipset and Intel® C200 Series Chipset Specification Update</i> for the value of the DID Register.

16.1.3 PCICMD—PCI Command Register (USB EHCI—D29:F0, D26:F0)

Address Offset: 04h–05h Attribute: R/W, RO
 Default Value: 0000h Size: 16 bits

Bit D	escription
15:11	Reserved
10	Interrupt Disable — R/W. 0 = The function is capable of generating interrupts. 1 = The function can not generate its interrupt to the interrupt controller. Note that the corresponding Interrupt Status bit (D29:F0, D26:F0:06h, bit 3) is not affected by the interrupt enable.
9	Fast Back to Back Enable (FBE) — RO. Hardwired to 0.
8	SERR# Enable (SERR_EN) — R/W. 0 = Disables EHC's capability to generate an SERR#. 1 = The Enhanced Host controller (EHC) is capable of generating (internally) SERR# in the following cases: <ul style="list-style-type: none"> • When it receive a completion status other than "successful" for one of its DMA initiated memory reads on DMI (and subsequently on its internal interface). • When it detects an address or command parity error and the Parity Error Response bit is set. • When it detects a data parity error (when the data is going into the EHC) and the Parity Error Response bit is set.
7	Wait Cycle Control (WCC) — RO. Hardwired to 0.



Bit	Description
6	<p>Parity Error Response (PER) — R/W. 0 = The EHC is not checking for correct parity (on its internal interface). 1 = The EHC is checking for correct parity (on its internal interface) and halt operation when bad parity is detected during the data phase.</p> <p>NOTE: If the EHC detects bad parity on the address or command phases when the bit is set to 1, the host controller does not take the cycle. It halts the host controller (if currently not halted) and sets the Host System Error bit in the USBSTS register. This applies to both requests and completions from the system interface.</p> <p>This bit must be set in order for the parity errors to generate SERR#.</p>
5	VGA Palette Snoop (VPS) — RO. Hardwired to 0.
4	Postable Memory Write Enable (PMWE) — RO. Hardwired to 0.
3	Special Cycle Enable (SCE) — RO. Hardwired to 0.
2	<p>Bus Master Enable (BME) — R/W. 0 = Disables this functionality. 1 = Enables the PCH to act as a master on the PCI bus for USB transfers.</p>
1	<p>Memory Space Enable (MSE) — R/W. This bit controls access to the USB 2.0 Memory Space registers. 0 = Disables this functionality. 1 = Enables accesses to the USB 2.0 registers. The Base Address register (D29:F0, D26:F0:10h) for USB 2.0 should be programmed before this bit is set.</p>
0	I/O Space Enable (IOSE) — RO. Hardwired to 0.



16.1.4 PCISTS—PCI Status Register (USB EHCI—D29:F0, D26:F0)

Address Offset: 06h–07h
Default Value: 0290h

Attribute: R/WC, RO
Size: 16 bits

Note: For the writable bits, software must write a 1 to clear bits that are set. Writing a 0 to the bit has no effect.

Bit D	Description
15	Detected Parity Error (DPE) — R/WC. 0 = No parity error detected. 1 = This bit is set by the PCH when a parity error is seen by the EHCI controller, regardless of the setting of bit 6 or bit 8 in the Command register or any other conditions.
14	Signaled System Error (SSE) — R/WC. 0 = No SERR# signaled by the PCH. 1 = This bit is set by the PCH when it signals SERR# (internally). The SER_EN bit (bit 8 of the Command Register) must be 1 for this bit to be set.
13	Received Master Abort (RMA) — R/WC. 0 = No master abort received by EHC on a memory access. 1 = This bit is set when EHC, as a master, receives a master abort status on a memory access. This is treated as a Host Error and halts the DMA engines. This event can optionally generate an SERR# by setting the SERR# Enable bit.
12	Received Target Abort (RTA) — R/WC. 0 = No target abort received by EHC on memory access. 1 = This bit is set when EHC, as a master, receives a target abort status on a memory access. This is treated as a Host Error and halts the DMA engines. This event can optionally generate an SERR# by setting the SERR# Enable bit (D29:F0, D26:F0:04h, bit 8).
11	Signaled Target Abort (STA) — RO. This bit is used to indicate when the EHCI function responds to a cycle with a target abort. There is no reason for this to happen, so this bit is hardwired to 0.
10:9	DEVSEL# Timing Status (DEVT_STS) — RO. This 2-bit field defines the timing for DEVSEL# assertion.
8	Master Data Parity Error Detected (DPED) — R/WC. 0 = No data parity error detected on USB2.0 read completion packet. 1 = This bit is set by the PCH when a data parity error is detected on a USB 2.0 read completion packet on the internal interface to the EHCI host controller and bit 6 of the Command register is set to 1.
7	Fast Back to Back Capable (FB2BC) — RO. Hardwired to 1.
6	User Definable Features (UDF) — RO. Hardwired to 0.
5	66 MHz Capable (66 MHz_CAP) — RO. Hardwired to 0.
4	Capabilities List (CAP_LIST) — RO. Hardwired to 1 indicating that offset 34h contains a valid capabilities pointer.
3	Interrupt Status — RO. This bit reflects the state of this function's interrupt at the input of the enable/disable logic. 0 = This bit will be 0 when the interrupt is deasserted. 1 = This bit is a 1 when the interrupt is asserted. The value reported in this bit is independent of the value in the Interrupt Enable bit.
2:0	Reserved



16.1.5 RID—Revision Identification Register (USB EHCI—D29:F0, D26:F0)

Offset Address: 08h Attribute: RO
 Default Value: See bit description Size: 8 bits

Bit	Description
7:0	Revision ID — RO. See the <i>Intel® 6 Series Chipset and Intel® C200 Series Chipset Specification Update</i> for the value of the RID Register.

16.1.6 PI—Programming Interface Register (USB EHCI—D29:F0, D26:F0)

Address Offset: 09h Attribute: RO
 Default Value: 20h Size: 8 bits

Bit De	scription
7:0	Programming Interface — RO. A value of 20h indicates that this USB 2.0 host controller conforms to the EHCI Specification.

16.1.7 SCC—Sub Class Code Register (USB EHCI—D29:F0, D26:F0)

Address Offset: 0Ah Attribute: RO
 Default Value: 03h Size: 8 bits

Bit De	scription
7:0	Sub Class Code (SCC) — RO. 03h = Universal serial bus host controller.

16.1.8 BCC—Base Class Code Register (USB EHCI—D29:F0, D26:F0)

Address Offset: 0Bh Attribute: RO
 Default Value: 0Ch Size: 8 bits

Bit De	scription
7:0	Base Class Code (BCC) — RO. 0Ch = Serial bus controller.

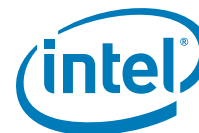

16.1.9 PMLT—Primary Master Latency Timer Register (USB EHCI—D29:F0, D26:F0)

Address Offset: 0Dh Attribute: RO
Default Value: 00h Size: 8 bits

Bit D	Description
7:0	Master Latency Timer Count (MLTC) — RO. Hardwired to 00h. Because the EHCI controller is internally implemented with arbitration on an interface (and not PCI), it does not need a master latency timer.

16.1.10 HEADTYP—Header Type Register (USB EHCI—D29:F0, D26:F0)

Address Offset: 0Eh Attribute: RO
Default Value: 80h Size: 8 bits

Bit	Description
7	Multi-Function Device — RO. When set to '1' indicates this is a multifunction device: 0 = Single-function device 1 = Multi-function device.
6:0	Configuration Layout. Hardwired to 00h, which indicates the standard PCI configuration layout.

16.1.11 MEM_BASE—Memory Base Address Register (USB EHCI—D29:F0, D26:F0)

Address Offset: 10h–13h Attribute: R/W, RO
Default Value: 00000000h Size: 32 bits

Bit D	Description
31:10	Base Address — R/W. Bits [31:10] correspond to memory address signals [31:10], respectively. This gives 1-KB of locatable memory space aligned to 1-KB boundaries.
9:4	Reserved
3	Prefetchable — RO. Hardwired to 0 indicating that this range should not be prefetched.
2:1	Type — RO. Hardwired to 00b indicating that this range can be mapped anywhere within 32-bit address space.
0	Resource Type Indicator (RTE) — RO. Hardwired to 0 indicating that the base address field in this register maps to memory space.



16.1.12 SVID—USB EHCI Subsystem Vendor ID Register (USB EHCI—D29:F0, D26:F0)

Address Offset: 2Ch–2Dh Attribute: R/W
 Default Value: XXXXh Size: 16 bits
 Reset: None

Bit De	scription
15:0	<p>Subsystem Vendor ID (SVID) — R/W. This register, in combination with the USB 2.0 Subsystem ID register, enables the operating system to distinguish each subsystem from the others.</p> <p>NOTE: Writes to this register are enabled when the WRT_RDONLY bit (D29:F0, D26:F0:80h, bit 0) is set to 1.</p>

16.1.13 SID—USB EHCI Subsystem ID Register (USB EHCI—D29:F0, D26:F0)

Address Offset: 2Eh–2Fh Attribute: R/W
 Default Value: XXXXh Size: 16 bits
 Reset: None

Bit De	scription
15:0	<p>Subsystem ID (SID) — R/W. BIOS sets the value in this register to identify the Subsystem ID. This register, in combination with the Subsystem Vendor ID register, enables the operating system to distinguish each subsystem from other(s).</p> <p>NOTE: Writes to this register are enabled when the WRT_RDONLY bit (D29:F0, D26:F0:80h, bit 0) is set to 1.</p>

16.1.14 CAP_PTR—Capabilities Pointer Register (USB EHCI—D29:F0, D26:F0)

Address Offset: 34h Attribute: RO
 Default Value: 50h Size: 8 bits

Bit De	scription
7:0	<p>Capabilities Pointer (CAP_PTR) — RO. This register points to the starting offset of the USB 2.0 capabilities ranges.</p>

16.1.15 INT_LN—Interrupt Line Register (USB EHCI—D29:F0, D26:F0)

Address Offset: 3Ch Attribute: R/W
 Default Value: 00h Size: 8 bits
 Function Level Reset: No

Bit De	scription
7:0	<p>Interrupt Line (INT_LN) — R/W. This data is not used by the PCH. It is used as a scratchpad register to communicate to software the interrupt line that the interrupt pin is connected to.</p>

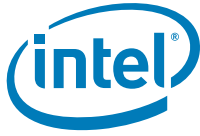

16.1.19 PWR_CAP—Power Management Capabilities Register (USB EHCI—D29:F0, D26:F0)

Address Offset: 52h-53h
Default Value: C9C2h

Attribute: R/W, RO
Size: 16 bits

Bit	Description
15:11	PME Support (PME_SUP) — R/W. This 5-bit field indicates the power states in which the function may assert PME#. The PCH EHC does not support the D1 or D2 states. For all other states, the PCH EHC is capable of generating PME#. Software should never need to modify this field.
10	D2 Support (D2_SUP) — RO. 0 = D2 State is not supported
9	D1 Support (D1_SUP) — RO. 0 = D1 State is not supported
8:6	Auxiliary Current (AUX_CUR) — R/W. The PCH EHC reports 375 mA maximum suspend well current required when in the D3 _{COLD} state.
5	Device Specific Initialization (DSI) — RO. The PCH reports 0, indicating that no device-specific initialization is required.
4	Reserved
3	PME Clock (PME_CLK) — RO. The PCH reports 0, indicating that no PCI clock is required to generate PME#.
2:0	Version (VER) — RO. The PCH reports 010b, indicating that it complies with Revision 1.1 of the PCI Power Management Specification.

NOTES:

1. Normally, this register is read-only to report capabilities to the power management software. To report different power management capabilities, depending on the system in which the PCH is used, bits 15:11 and 8:6 in this register are writable when the WRT_RDONLY bit (D29:F0, D26:F0:80h, bit 0) is set. The value written to this register does not affect the hardware other than changing the value returned during a read.
2. Reset: core well, but not D3-to-D0 warm reset.



16.1.20 PWR_CNTL_STS—Power Management Control/Status Register (USB EHCI—D29:F0, D26:F0)

Address Offset: 54h–55h Attribute: R/W, R/WC, RO
 Default Value: 0000h Size: 16 bits
 Function Level Reset: No (Bits 8 and 15 only)

Bit	Description
15	<p>PME Status — R/WC. 0 = Writing a 1 to this bit will clear it and cause the internal PME to deassert (if enabled). 1 = This bit is set when the PCH EHC would normally assert the PME# signal independent of the state of the PME_En bit.</p> <p>NOTE: This bit must be explicitly cleared by the operating system each time the operating system is loaded. This bit is not reset by Function Level Reset.</p>
14:13	Data Scale — RO. Hardwired to 00b indicating it does not support the associated Data register.
12:9	Data Select — RO. Hardwired to 0000b indicating it does not support the associated Data register.
8	<p>PME Enable — R/W. 0 = Disable. 1 = Enables the PCH EHC to generate an internal PME signal when PME_Status is 1.</p> <p>NOTE: This bit must be explicitly cleared by the operating system each time it is initially loaded. This bit is not reset by Function Level Reset.</p>
7:2	Reserved
1:0	<p>Power State — R/W. This 2-bit field is used both to determine the current power state of EHC function and to set a new power state. The definition of the field values are: 00 = D0 state 11 = D3_{HOT} state</p> <p>If software attempts to write a value of 10b or 01b in to this field, the write operation must complete normally; however, the data is discarded and no state change occurs. When in the D3_{HOT} state, the PCH must not accept accesses to the EHC memory range; but the configuration space must still be accessible. When not in the D0 state, the generation of the interrupt output is blocked. Specifically, the PIRQH is not asserted by the PCH when not in the D0 state.</p> <p>When software changes this value from the D3_{HOT} state to the D0 state, an internal warm (soft) reset is generated, and software must re-initialize the function.</p>

NOTE: Reset (bits 15, 8): suspend well, and not D3-to-D0 warm reset nor core well reset.

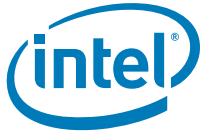

16.1.21 DEBUG_CAPID—Debug Port Capability ID Register (USB EHCI—D29:F0, D26:F0)

Address Offset: 58h	Attribute: RO
Default Value: 0Ah	Size: 8 bits

Bit	Description
7:0	Debug Port Capability ID — RO. Hardwired to 0Ah indicating that this is the start of a Debug Port Capability structure.

16.1.22 NXT_PTR2—Next Item Pointer #2 Register (USB EHCI—D29:F0, D26:F0)

Address Offset: 59h	Attribute: RO
Default Value: 98h	Size: 8 bits
Function Level Reset: No	

Bit	Description
7:0	Next Item Pointer 2 Capability — RO. This register points to the next capability in the Function Level Reset capability structure.

16.1.23 DEBUG_BASE—Debug Port Base Offset Register (USB EHCI—D29:F0, D26:F0)

Address Offset: 5Ah-5Bh	Attribute: RO
Default Value: 20A0h	Size: 16 bits

Bit	Description
15:13	BAR Number — RO. Hardwired to 001b to indicate the memory BAR begins at offset 10h in the EHCI configuration space.
12:0	Debug Port Offset — RO. Hardwired to 0A0h to indicate that the Debug Port registers begin at offset A0h in the EHCI memory range.

16.1.24 USB_RELNUM—USB Release Number Register (USB EHCI—D29:F0, D26:F0)

Address Offset: 60h	Attribute: RO
Default Value: 20h	Size: 8 bits

Bit	Description
7:0	USB Release Number — RO. A value of 20h indicates that this controller follows <i>Universal Serial Bus (USB) Specification, Revision 2.0</i> .



16.1.25 FL_ADJ—Frame Length Adjustment Register (USB EHCI—D29:F0, D26:F0)

Address Offset: 61h Attribute: R/W
 Default Value: 20h Size: 8 bits
 Function Level Reset: No

This feature is used to adjust any offset from the clock source that generates the clock that drives the SOF counter. When a new value is written into these six bits, the length of the frame is adjusted. Its initial programmed value is system dependent based on the accuracy of hardware USB clock and is initialized by system BIOS. This register should only be modified when the HChalted bit (D29:F0, D26:F0:CAPLENGTH + 24h, bit 12) in the USB2.0_STS register is a 1. Changing value of this register while the host controller is operating yields undefined results. It should not be reprogrammed by USB system software unless the default or BIOS programmed values are incorrect, or the system is restoring the register while returning from a suspended state.

These bits in suspend well and not reset by a D3-to-D0 warm rest or a core well reset.

Bit D	Description	
7:6	Reserved — RO. These bits are reserved for future use and should read as 00b.	
5:0	Frame Length Timing Value — R/W. Each decimal value change to this register corresponds to 16 high-speed bit times. The SOF cycle time (number of SOF counter clock periods to generate a SOF micro-frame length) is equal to 59488 + value in this field. The default value is decimal 32 (20h) that gives a SOF cycle time of 60000.	
	Frame Length (# 480 MHz Clocks) (decimal)	Frame Length Timing Value (this register) (decimal)
	59488	0
	59504	1
	59520	2
	—	—
	59984	31
	60000	32
—	—	
—	—	



16.1.26 PWAKE_CAP—Port Wake Capability Register (USB EHCI—D29:F0, D26:F0)

Address Offset: 62–63h Attribute: R/W
Default Value: 01FFh Size: 16 bits
Default Value: 07FFh
Function Level Reset: No

This register is in the suspend power well. The intended use of this register is to establish a policy about which ports are to be used for wake events. Bit positions 1–8(D29) or 1–6(D26) in the mask correspond to a physical port implemented on the current EHCI controller. A 1 in a bit position indicates that a device connected below the port can be enabled as a wake-up device and the port may be enabled for disconnect/connect or overcurrent events as wake-up events. This is an information-only mask register. The bits in this register **do not** affect the actual operation of the EHCI host controller. The system-specific policy can be established by BIOS initializing this register to a system-specific value. System software uses the information in this register when enabling devices and ports for remote wake-up.

These bits are not reset by a D3-to-D0 warm rest or a core well reset.

Bit D	Description
15:9 (D29) 15:7 (D26)	Reserved.
8:1 (D29) 6:1 (D26)	Port Wake Up Capability Mask — R/W. Bit positions 1 through 8 (Device 29) or 1 through 6 (Device 26) correspond to a physical port implemented on this host controller. For example, bit position 1 corresponds to port 1, bit position 2 corresponds to port 2, etc.
0	Port Wake Implemented — R/W. A 1 in this bit indicates that this register is implemented to software.

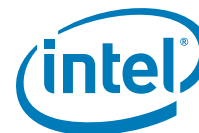

16.1.27 LEG_EXT_CAP—USB EHCI Legacy Support Extended Capability Register (USB EHCI—D29:F0, D26:F0)

Address Offset: 68–6Bh Attribute: R/W, RO
 Default Value: 00000001h Size: 32 bits
 Power Well: Suspend
 Function Level Reset: No

Note: These bits are not reset by a D3-to-D0 warm rest or a core well reset.

Bit D	Description
31:25	Reserved — RO. Hardwired to 00h
24	HC OS Owned Semaphore — R/W. System software sets this bit to request ownership of the EHCI controller. Ownership is obtained when this bit reads as 1 and the HC BIOS Owned Semaphore bit reads as clear.
23:17	Reserved — RO. Hardwired to 00h
16	HC BIOS Owned Semaphore — R/W. The BIOS sets this bit to establish ownership of the EHCI controller. System BIOS will clear this bit in response to a request for ownership of the EHCI controller by system software.
15:8	Next EHCI Capability Pointer — RO. Hardwired to 00h to indicate that there are no EHCI Extended Capability structures in this device.
7:0	Capability ID — RO. Hardwired to 01h to indicate that this EHCI Extended Capability is the Legacy Support Capability.



16.1.28 LEG_EXT_CS—USB EHCI Legacy Support Extended Control / Status Register (USB EHCI—D29:F0, D26:F0)

Address Offset: 6C–6Fh Attribute: R/W, R/WC, RO
 Default Value: 00000000h Size: 32 bits
 Power Well: Suspend
 Function Level Reset: No

Note: These bits are not reset by a D3-to-D0 warm rest or a core well reset.

Bit Description	Description
31	SMI on BAR — R/WC. Software clears this bit by writing a 1 to it. 0 = Base Address Register (BAR) not written. 1 = This bit is set to 1 when the Base Address Register (BAR) is written.
30	SMI on PCI Command — R/WC. Software clears this bit by writing a 1 to it. 0 = PCI Command (PCICMD) Register Not written. 1 = This bit is set to 1 when the PCI Command (PCICMD) Register is written.
29	SMI on OS Ownership Change — R/WC. Software clears this bit by writing a 1 to it. 0 = No HC OS Owned Semaphore bit change. 1 = This bit is set to 1 when the HC OS Owned Semaphore bit in the LEG_EXT_CAP register (D29:F0, D26:F0:68h, bit 24) transitions from 1 to 0 or 0 to 1.
28:22	Reserved.
21	SMI on Async Advance — RO. This bit is a shadow bit of the Interrupt on Async Advance bit (D29:F0, D26:F0:CAPLENGTH + 24h, bit 5) in the USB2.0_STS register. NOTE: To clear this bit system software must write a 1 to the Interrupt on Async Advance bit in the USB2.0_STS register.
20	SMI on Host System Error — RO. This bit is a shadow bit of Host System Error bit in the USB2.0_STS register (D29:F0, D26:F0:CAPLENGTH + 24h, bit 4). NOTE: To clear this bit system software must write a 1 to the Host System Error bit in the USB2.0_STS register.
19	SMI on Frame List Rollover — RO. This bit is a shadow bit of Frame List Rollover bit (D29:F0, D26:F0:CAPLENGTH + 24h, bit 3) in the USB2.0_STS register. NOTE: To clear this bit system software must write a 1 to the Frame List Rollover bit in the USB2.0_STS register.
18	SMI on Port Change Detect — RO. This bit is a shadow bit of Port Change Detect bit (D29:F0, D26:F0:CAPLENGTH + 24h, bit 2) in the USB2.0_STS register. NOTE: To clear this bit system software must write a 1 to the Port Change Detect bit in the USB2.0_STS register.
17	SMI on USB Error — RO. This bit is a shadow bit of USB Error Interrupt (USBERRINT) bit (D29:F0, D26:F0:CAPLENGTH + 24h, bit 1) in the USB2.0_STS register. NOTE: To clear this bit system software must write a 1 to the USB Error Interrupt bit in the USB2.0_STS register.
16	SMI on USB Complete — RO. This bit is a shadow bit of USB Interrupt (USBINT) bit (D29:F0, D26:F0:CAPLENGTH + 24h, bit 0) in the USB2.0_STS register. NOTE: To clear this bit system software must write a 1 to the USB Interrupt bit in the USB2.0_STS register.



Bit D	Description
15	SMI on BAR Enable — R/W. 0 = Disable. 1 = Enable. When this bit is 1 and SMI on BAR (D29:F0, D26:F0:6Ch, bit 31) is 1, then the host controller will issue an SMI.
14	SMI on PCI Command Enable — R/W. 0 = Disable. 1 = Enable. When this bit is 1 and SMI on PCI Command (D29:F0, D26:F0:6Ch, bit 30) is 1, then the host controller will issue an SMI.
13	SMI on OS Ownership Enable — R/W. 0 = Disable. 1 = Enable. When this bit is a 1 AND the OS Ownership Change bit (D29:F0, D26:F0:6Ch, bit 29) is 1, the host controller will issue an SMI.
12:6	Reserved
5	SMI on Async Advance Enable — R/W. 0 = Disable. 1 = Enable. When this bit is a 1, and the SMI on Async Advance bit (D29:F0, D26:F0:6Ch, bit 21) is a 1, the host controller will issue an SMI immediately.
4	SMI on Host System Error Enable — R/W. 0 = Disable. 1 = Enable. When this bit is a 1, and the SMI on Host System Error (D29:F0, D26:F0:6Ch, bit 20) is a 1, the host controller will issue an SMI.
3	SMI on Frame List Rollover Enable — R/W. 0 = Disable. 1 = Enable. When this bit is a 1, and the SMI on Frame List Rollover bit (D29:F0, D26:F0:6Ch, bit 19) is a 1, the host controller will issue an SMI.
2	SMI on Port Change Enable — R/W. 0 = Disable. 1 = Enable. When this bit is a 1, and the SMI on Port Change Detect bit (D29:F0, D26:F0:6Ch, bit 18) is a 1, the host controller will issue an SMI.
1	SMI on USB Error Enable — R/W. 0 = Disable. 1 = Enable. When this bit is a 1, and the SMI on USB Error bit (D29:F0, D26:F0:6Ch, bit 17) is a 1, the host controller will issue an SMI immediately.
0	SMI on USB Complete Enable — R/W. 0 = Disable. 1 = Enable. When this bit is a 1, and the SMI on USB Complete bit (D29:F0, D26:F0:6Ch, bit 16) is a 1, the host controller will issue an SMI immediately.



16.1.29 SPECIAL_SMI—Intel Specific USB 2.0 SMI Register (USB EHCI—D29:F0, D26:F0)

Address Offset: 70h–73h Attribute: R/W, R/WC
 Default Value: 00000000h Size: 32 bits
 Power Well: Suspend
 Function Level Reset: No

Note: These bits are not reset by a D3-to-D0 warm rest or a core well reset.

Bit D	Description
31:25	Reserved.
24:22	SMI on PortOwner — R/WC. Software clears these bits by writing a 1 to it. 0 = No Port Owner bit change. 1 = Bits 24:22 correspond to the Port Owner bits for ports 0 (22) through 3 (24). These bits are set to 1 when the associated Port Owner bits transition from 0 to 1 or 1 to 0.
21	SMI on PMCSR — R/WC. Software clears these bits by writing a 1 to it. 0 = Power State bits Not modified. 1 = Software modified the Power State bits in the Power Management Control/Status (PMCSR) register (D29:F0, D26:F0:54h).
20	SMI on Async — R/WC. Software clears these bits by writing a 1 to it. 0 = No Async Schedule Enable bit change 1 = Async Schedule Enable bit transitioned from 1 to 0 or 0 to 1.
19	SMI on Periodic — R/WC. Software clears this bit by writing a 1 it. 0 = No Periodic Schedule Enable bit change. 1 = Periodic Schedule Enable bit transitions from 1 to 0 or 0 to 1.
18	SMI on CF — R/WC. Software clears this bit by writing a 1 it. 0 = No Configure Flag (CF) change. 1 = Configure Flag (CF) transitions from 1 to 0 or 0 to 1.
17	SMI on HCHalted — R/WC. Software clears this bit by writing a 1 it. 0 = HCHalted did Not transition to 1 (as a result of the Run/Stop bit being cleared). 1 = HCHalted transitions to 1 (as a result of the Run/Stop bit being cleared).
16	SMI on HCRreset — R/WC. Software clears this bit by writing a 1 it. 0 = HCRESET did Not transitioned to 1. 1 = HCRESET transitioned to 1.
15:14	Reserved
13:6	SMI on PortOwner Enable — R/W. 0 = Disable. 1 = Enable. When any of these bits are 1 and the corresponding SMI on PortOwner bits are 1, then the host controller will issue an SMI. Unused ports should have their corresponding bits cleared.
5	SMI on PMSCR Enable — R/W. 0 = Disable. 1 = Enable. When this bit is 1 and SMI on PMSCR is 1, then the host controller will issue an SMI.
4	SMI on Async Enable — R/W. 0 = Disable. 1 = Enable. When this bit is 1 and SMI on Async is 1, then the host controller will issue an SMI



Bit De	escription
3	SMI on Periodic Enable — R/W. 0 = Disable. 1 = Enable. When this bit is 1 and SMI on Periodic is 1, then the host controller will issue an SMI.
2	SMI on CF Enable — R/W. 0 = Disable. 1 = Enable. When this bit is 1 and SMI on CF is 1, then the host controller will issue an SMI.
1	SMI on HCHalted Enable — R/W. 0 = Disable. 1 = Enable. When this bit is a 1 and SMI on HCHalted is 1, then the host controller will issue an SMI.
0	SMI on HCRreset Enable — R/W. 0 = Disable. 1 = Enable. When this bit is a 1 and SMI on HCRreset is 1, then host controller will issue an SMI.

16.1.30 ACCESS_CNTL—Access Control Register (USB EHCI—D29:F0, D26:F0)

Address Offset: 80h Attribute: R/W
 Default Value: 00h Size: 8 bits
 Function Level Reset: No

Bit D	escription
7:1	Reserved
0	WRT_RDONLY — R/W. When set to 1, this bit enables a select group of normally read-only registers in the EHC function to be written by software. Registers that may only be written when this mode is entered are noted in the summary tables and detailed description as "Read/Write-Special". The registers fall into two categories: 1. System-configured parameters 2. Status bits



16.1.35 FLR_CLV—Function Level Reset Capability Length and Version Register (USB EHCI—D29:F0, D26:F0)

Address Offset: 9Ah–9Bh Attribute: R/WO, RO
 Default Value: 2006h Size: 16 bits
 Function Level Reset: No

When FLRCSSEL = 0, this register is defined as follows:

Bit De	scription
15:10	Reserved
9	FLR Capability — R/WO. 1 = Support for Function Level Reset (FLR).
8	TXP Capability — R/WO. 1 = Support for Transactions Pending (TXP) bit. TXP must be supported if FLR is supported.
7:0	Capability Length — RO. This field indicates the # of bytes of this vendor specific capability as required by the PCI specification. It has the value of 06h for the FLR capability.

When FLRCSSEL = 1, this register is defined as follows:

Bit De	scription
15:12	Vendor Specific Capability ID — RO. A value of 2h in this field identifies this capability as Function Level Reset.
11:8	Capability Version — RO. This field indicates the version of the FLR capability.
7:0	Capability Length — RO. This field indicates the # of bytes of this vendor specific capability as required by the PCI specification. It has the value of 06h for the FLR capability.

16.1.36 FLR_CTRL—Function Level Reset Control Register (USB EHCI—D29:F0, D26:F0)

Address Offset: 9Ch Attribute: R/W
 Default Value: 00h Size: 8 bits
 Function Level Reset: No

Bit De	scription
7:1	Reserved
0	Initiate FLR — R/W. This bit is used to initiate FLR transition. A write of 1 initiates FLR transition. Since hardware must not respond to any cycles until FLR completion, the value read by software from this bit is always 0.



16.1.37 FLR_STS—Function Level Reset Status Register (USB EHCI—D29:F0, D26:F0)

Address Offset: 9Dh Attribute: RO
 Default Value: 00h Size: 8 bits
 Function Level Reset: No

Bit D	Description
7:1	Reserved
0	Transactions Pending (TXP) — RO. 0 = Completions for all non-posted requests have been received. 1 = Controller has issued non-posted requests which have not been completed.

16.1.38 EHCIIR3—EHCI Initialization Register 3 (USB EHCI—D29:F0, D26:F0)

Offset Address: F4h–F7h Attribute: R/W
 Default Value: 00408588h Size: 32-bit

Bit D	Description
31	EHCIIR3 Write Enable — R/W. 0 = Writes to the EHCIIR3 register are disabled 1 = If set, the values of the EHCIIR3 register may be modified
30:24	Reserved
23:22	EHCI Initialization Register 3 Field 1 — R/W. BIOS must program this field to 10b.
21:0	Reserved

16.1.39 EHCIIR4—EHCI Initialization Register 4 (USB EHCI—D29:F0, D26:F0)

Offset Address: FCh–FFh Attribute: R/W
 Default Value: 20591708h Size: 32-bit

Bit D	Description
31:18	Reserved
17	EHCI Initialization Register 4 Field 2 — R/W. BIOS must set this bit to 1.
16	Reserved
15	EHCI Initialization Register 4 Field 1 — R/W. BIOS must set this bit to 1.
14:0	Reserved



16.2 Memory-Mapped I/O Registers

The EHCI memory-mapped I/O space is composed of two sets of registers—Capability Registers and Operational Registers.

Note: The PCH EHCI controller will not accept memory transactions (neither reads nor writes) as a target that are locked transactions. The locked transactions should not be forwarded to PCI as the address space is known to be allocated to USB.

Note: When the EHCI function is in the D3 PCI power state, accesses to the USB 2.0 memory range are ignored and result a master abort. Similarly, if the Memory Space Enable (MSE) bit (D29:F0, D26:F0:04h, bit 1) is not set in the Command register in configuration space, the memory range will not be decoded by the PCH enhanced host controller (EHC). If the MSE bit is not set, the PCH must default to allowing any memory accesses for the range specified in the BAR to go to PCI. This is because the range may not be valid and, therefore, the cycle must be made available to any other targets that may be currently using that range.

16.2.1 Host Controller Capability Registers

These registers specify the limits, restrictions and capabilities of the host controller implementation. Within the host controller capability registers, only the structural parameters register is writable. These registers are implemented in the suspend well and is only reset by the standard suspend-well hardware reset, not by HCRESET or the D3-to-D0 reset.

Note: Note that the EHCI controller does not support as a target memory transactions that are locked transactions. Attempting to access the EHCI controller Memory-Mapped I/O space using locked memory transactions will result in undefined behavior.

Note: Note that when the USB2 function is in the D3 PCI power state, accesses to the USB2 memory range are ignored and will result in a master abort. Similarly, if the Memory Space Enable (MSE) bit is not set in the Command register in configuration space, the memory range will not be decoded by the Enhanced Host Controller (EHC). If the MSE bit is not set, the EHC will not claim any memory accesses for the range specified in the BAR.

Table 16-2. Enhanced Host Controller Capability Registers

MEM_BASE + Offset	Mnemonic	Register De	fault	Attribute
00h	CAPLENGTH	Capabilities Registers Length	20h	RO
02h-03h	HCIVERSION	Host Controller Interface Version Number	0100h	RO
04h-07h	HCSPARAMS	Host Controller Structural Parameters	00204208h (D29:F0) 00203206 (D26:F0)	R/W (special), RO
08h-0Bh	HCCPARAMS	Host Controller Capability Parameters	00006881h	RO

NOTE: “Read/Write Special” means that the register is normally read-only, but may be written when the WRT_RDONLY bit is set. Because these registers are expected to be programmed by BIOS during initialization, their contents must not get modified by HCRESET or D3-to-D0 internal reset.



16.2.1.1 CAPLENGTH—Capability Registers Length Register

Offset: MEM_BASE + 00h Attribute: RO
 Default Value: 20h Size: 8 bits

Bit D	Description
7:0	Capability Register Length Value — RO. This register is used as an offset to add to the Memory Base Register (D29:F0, D26:F0:10h) to find the beginning of the Operational Register Space. This field is hardwired to 20h indicating that the Operation Registers begin at offset 20h.

16.2.1.2 HCIVERSION—Host Controller Interface Version Number Register

Offset: MEM_BASE + 02h-03h Attribute: RO
 Default Value: 0100h Size: 16 bits

Bit D	Description
15:0	Host Controller Interface Version Number — RO. This is a two-byte register containing a BCD encoding of the version number of interface that this host controller interface conforms.

16.2.1.3 HCSPARAMS—Host Controller Structural Parameters Register

Offset: MEM_BASE + 04h-07h Attribute: R/W, RO
 Default Value: 00204208h (D29:F0) Size: 32 bits
 00203206h (D26:F0)

Function Level Reset: No

Note: This register is reset by a suspend well reset and not a D3-to-D0 reset or HCRESET.

Bit D	Description
31:24	Reserved
23:20	Debug Port Number (DP_N) — RO. Hardwired to 2h indicating that the Debug Port is on the second lowest numbered port on the EHCI. EHCI#1: Port 1 EHCI#2: Port 9
19:16	Reserved
15:12	Number of Companion Controllers (N_CC) — R/W. This field indicates the number of companion controllers associated with this USB EHCI host controller. BIOS must program this field to 0b to indicate companion host controllers are not supported. Port-ownership hand-off is not supported. Only high-speed devices are supported on the host controller root ports.
11:8	Number of Ports per Companion Controller (N_PCC) — RO. This field indicates the number of ports supported per companion host controller. This field is 0h indication no other companion controller support.
7:4	Reserved. These bits are reserved and default to 0.
3:0	N_PORTS — R/W. This field specifies the number of physical downstream ports implemented on this host controller. The value of this field determines how many port registers are addressable in the Operational Register Space. Valid values are in the range of 1h to Fh. A 0 in this field is undefined. For Integrated USB 2.0 Rate Matching Hub Enabled: Each EHCI reports 2 ports by default. Port 0 assigned to the RMH and port 1 assigned as the debug port. When the KVM/USB-R feature is enabled it will show up as Port2 on the EHCI, and BIOS would need to update this field to 3h.

NOTE: This register is writable when the WRT_RDONLY bit is set.



16.2.1.4 HCCPARAMS—Host Controller Capability Parameters Register

Offset: MEM_BASE + 08h-0Bh Attribute: RO
 Default Value: 00006881h Size: 32 bits

Bit De	scription
31:18	Reserved
17	Asynchronous Schedule Update Capability (ASUC) — R/W. There is no functionality associated with this bit.
16	Periodic Schedule Update Capability (PSUC) — RO. This field is hardwired to 0b to indicate that the EHC hardware supports the Periodic Schedule Update Event Flag in the USB2.0_CMD register.
15:8	EHCI Extended Capabilities Pointer (EECP) — RO. This field is hardwired to 68h, indicating that the EHCI capabilities list exists and begins at offset 68h in the PCI configuration space.
7:4	Isochronous Scheduling Threshold — RO. This field indicates, relative to the current position of the executing host controller, where software can reliably update the isochronous schedule. When bit 7 is 0, the value of the least significant 3 bits indicates the number of micro-frames a host controller hold a set of isochronous data structures (one or more) before flushing the state. When bit 7 is a 1, then host software assumes the host controller may cache an isochronous data structure for an entire frame. Refer to the EHCI specification for details on how software uses this information for scheduling isochronous transfers. This field is hardwired to 8h.
3	Reserved
2	Asynchronous Schedule Park Capability — RO. This bit is hardwired to 0 indicating that the host controller does not support this optional feature
1	Programmable Frame List Flag — RO. 0 = System software must use a frame list length of 1024 elements with this host controller. The USB2.0_CMD register (D29:F0, D26:F0:CAPLENGTH + 20h, bits 3:2) <i>Frame List Size</i> field is a read-only register and must be set to 0. 1 = System software can specify and use a smaller frame list and configure the host controller using the USB2.0_CMD register <i>Frame List Size</i> field. The frame list must always be aligned on a 4K page boundary. This requirement ensures that the frame list is always physically contiguous.
0	64-bit Addressing Capability — RO. This field documents the addressing range capability of this implementation. The value of this field determines whether software should use the 32-bit or 64-bit data structures. This bit is hardwired to 1. NOTE: The PCH supports 64 bit addressing only.



16.2.2 Host Controller Operational Registers

This section defines the enhanced host controller operational registers. These registers are located after the capabilities registers. The operational register base must be DWord-aligned and is calculated by adding the value in the first capabilities register (CAPLENGTH) to the base address of the enhanced host controller register address space (MEM_BASE). Since CAPLENGTH is always 20h, Table 16-3 already accounts for this offset. All registers are 32 bits in length.

Table 16-3. Enhanced Host Controller Operational Register Address Map

MEM_BASE + Offset	Mnemonic	Register Name	Default	Special Notes	Attribute
20h–23h	USB2.0_CMD	USB 2.0 Command	00080000h		R/W, RO
24h–27h	USB2.0_STS	USB 2.0 Status	00001000h		R/WC, RO
28h–2Bh	USB2.0_INTR	USB 2.0 Interrupt Enable	00000000h		R/W
2Ch–2Fh	FRINDEX	USB 2.0 Frame Index	00000000h		R/W
30h–33h	CTRLDSSEGMENT	Control Data Structure Segment	00000000h		R/W, RO
34h–37h	PERODICLISTBASE	Period Frame List Base Address	00000000h		R/W
38h–3Bh	ASYNCLISTADDR	Current Asynchronous List Address	00000000h		R/W
3Ch–5Fh	—	Reserved	0h		RO
60h–63h	CONFIGFLAG	Configure Flag	00000000h	Suspend	R/W
64h–67h	PORT0SC	Port 0 Status and Control	00003000h	Suspend	R/W, R/WC, RO
68h–6Bh	PORT1SC	Port 1 Status and Control	00003000h	Suspend	R/W, R/WC, RO
6Ch–6Fh	PORT2SC	Port 2 Status and Control	00003000h	Suspend	R/W, R/WC, RO
70h–73h	PORT3SC	Port 3 Status and Control	00003000h	Suspend	R/W, R/WC, RO
74h–77h	PORT4SC	Port 4 Status and Control	00003000h	Suspend	R/W, R/WC, RO
78h–7Bh	PORT5SC	Port 5 Status and Control	00003000h	Suspend	R/W, R/WC, RO
74h–77h (D29 Only)	PORT6SC	Port 6 Status and Control	00003000h	Suspend	R/W, R/WC, RO
78h–7Bh (D29 Only)	PORT7SC	Port 7 Status and Control	00003000h	Suspend	R/W, R/WC, RO
7Ch–9Fh	—	Reserved	Undefined		RO
A0h–B3h	—	Debug Port Registers	Undefined		See register description
B4h–3FFh	—	Reserved	Undefined		RO

Note: Software must read and write these registers using only DWord accesses. These registers are divided into two sets. The first set at offsets MEM_BASE + 00:3Bh are implemented in the core power well. Unless otherwise noted, the core well registers are reset by the assertion of any of the following:

- Core well hardware reset
- HCRESET
- D3-to-D0 reset



The second set at offsets MEM_BASE + 60h to the end of the implemented register space are implemented in the Suspend power well. Unless otherwise noted, the suspend well registers are reset by the assertion of either of the following:

- Suspend well hardware reset
- HCRESET

16.2.2.1 USB2.0_CMD—USB 2.0 Command Register

Offset: MEM_BASE + 20–23h Attribute: R/W, RO
 Default Value: 00080000h Size: 32 bits

Bit De	scription																		
31:24	Reserved																		
23:16	<p>Interrupt Threshold Control — R/W. System software uses this field to select the maximum rate at which the host controller will issue interrupts. The only valid values are defined below. If software writes an invalid value to this register, the results are undefined.</p> <table border="1"> <thead> <tr> <th>Value</th> <th>Maximum Interrupt Interval</th> </tr> </thead> <tbody> <tr> <td>00h</td> <td>Reserved</td> </tr> <tr> <td>01h</td> <td>1 micro-frame</td> </tr> <tr> <td>02h</td> <td>2 micro-frames</td> </tr> <tr> <td>04h</td> <td>4 micro-frames</td> </tr> <tr> <td>08h</td> <td>8 micro-frames (default, equates to 1 ms)</td> </tr> <tr> <td>10h</td> <td>16 micro-frames (2 ms)</td> </tr> <tr> <td>20h</td> <td>32 micro-frames (4 ms)</td> </tr> <tr> <td>40h</td> <td>64 micro-frames (8 ms)</td> </tr> </tbody> </table>	Value	Maximum Interrupt Interval	00h	Reserved	01h	1 micro-frame	02h	2 micro-frames	04h	4 micro-frames	08h	8 micro-frames (default, equates to 1 ms)	10h	16 micro-frames (2 ms)	20h	32 micro-frames (4 ms)	40h	64 micro-frames (8 ms)
Value	Maximum Interrupt Interval																		
00h	Reserved																		
01h	1 micro-frame																		
02h	2 micro-frames																		
04h	4 micro-frames																		
08h	8 micro-frames (default, equates to 1 ms)																		
10h	16 micro-frames (2 ms)																		
20h	32 micro-frames (4 ms)																		
40h	64 micro-frames (8 ms)																		
15:14	Reserved																		
13	Asynch Schedule Update (ASC) — R/W. There is no functionality associated with this bit.																		
12	<p>Periodic Schedule Prefetch Enable — R/W. This bit is used by software to enable the host controller to prefetch the periodic schedule even in C0. 0 = Pre-fetch based pause enabled only when not in C0. 1 = Pre-fetch based pause enable in C0.</p> <p>Once software has written a 1b to this bit to enable periodic schedule prefetching, it must disable prefetching by writing a 0b to this bit whenever periodic schedule updates are about to begin. Software should continue to dynamically disable and re-enable the prefetcher surrounding any updates to the periodic scheduler (that is, until the host controller has been reset using a HCRESET).</p>																		
11:8	Unimplemented Asynchronous Park Mode Bits — RO. Hardwired to 000b indicating the host controller does not support this optional feature.																		
7	Light Host Controller Reset — RO. Hardwired to 0. The PCH does not implement this optional reset.																		



Bit D	Description
6	<p>Interrupt on Async Advance Doorbell — R/W. This bit is used as a doorbell by software to tell the host controller to issue an interrupt the next time it advances asynchronous schedule.</p> <p>0 = The host controller sets this bit to a 0 after it has set the Interrupt on Async Advance status bit (D29:F0, D26:F0:CAPLENGTH + 24h, bit 5) in the USB2.0_STS register to a 1.</p> <p>1 = Software must write a 1 to this bit to ring the doorbell. When the host controller has evicted all appropriate cached schedule state, it sets the Interrupt on Async Advance status bit in the USB2.0_STS register. If the <i>Interrupt on Async Advance Enable</i> bit in the USB2.0_INTR register (D29:F0, D26:F0:CAPLENGTH + 28h, bit 5) is a 1 then the host controller will assert an interrupt at the next interrupt threshold. See the EHCI specification for operational details.</p> <p>NOTE: Software should not write a 1 to this bit when the asynchronous schedule is inactive. Doing so will yield undefined results.</p>
5	<p>Asynchronous Schedule Enable — R/W. This bit controls whether the host controller skips processing the Asynchronous Schedule.</p> <p>0 = Do not process the Asynchronous Schedule</p> <p>1 = Use the ASYNCLISTADDR register to access the Asynchronous Schedule.</p>
4	<p>Periodic Schedule Enable — R/W. This bit controls whether the host controller skips processing the Periodic Schedule.</p> <p>0 = Do not process the Periodic Schedule</p> <p>1 = Use the PERIODICLISTBASE register to access the Periodic Schedule.</p>
3:2	<p>Frame List Size — RO. The PCH hardwires this field to 00b because it only supports the 1024-element frame list size.</p>
1	<p>Host Controller Reset (HCRESET) — R/W. This control bit used by software to reset the host controller. The effects of this on root hub registers are similar to a Chip Hardware Reset (that is, RSMRST# assertion and PWROK deassertion on the PCH). When software writes a 1 to this bit, the host controller resets its internal pipelines, timers, counters, state machines, etc. to their initial value. Any transaction currently in progress on USB is immediately terminated. A USB reset is not driven on downstream ports.</p> <p>NOTE: PCI configuration registers and Host controller capability registers are not effected by this reset.</p> <p>All operational registers, including port registers and port state machines are set to their initial values. Port ownership reverts to the companion host controller(s), with the side effects described in the EHCI specification. Software must re-initialize the host controller in order to return the host controller to an operational state.</p> <p>This bit is set to 0 by the host controller when the reset process is complete. Software cannot terminate the reset process early by writing a 0 to this register.</p> <p>Software should not set this bit to a 1 when the HCHalted bit (D29:F0, D26:F0:CAPLENGTH + 24h, bit 12) in the USB2.0_STS register is a 0. Attempting to reset an actively running host controller will result in undefined behavior. This reset may be used to leave EHCI port test modes.</p>

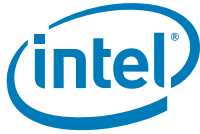

Bit De	scription															
0	<p>Run/Stop (RS) — R/W. 0 = Stop (default) 1 = Run. When set to a 1, the Host controller proceeds with execution of the schedule. The Host controller continues execution as long as this bit is set. When this bit is set to 0, the Host controller completes the current transaction on the USB and then halts. The HCHalted bit in the USB2.0_STS register indicates when the Host controller has finished the transaction and has entered the stopped state.</p> <p>Software should not write a 1 to this field unless the host controller is in the Halted state (that is, HCHalted in the USBSTS register is a 1). The Halted bit is cleared immediately when the Run bit is set.</p> <p>The following table explains how the different combinations of Run and Halted should be interpreted:</p> <table border="1" style="margin-left: 40px;"> <thead> <tr> <th>Run/Stop</th> <th>Halted</th> <th>Interpretation</th> </tr> </thead> <tbody> <tr> <td style="text-align: center;">0b</td> <td style="text-align: center;">0b</td> <td>In the process of halting</td> </tr> <tr> <td style="text-align: center;">0b</td> <td style="text-align: center;">1b</td> <td>Halted</td> </tr> <tr> <td style="text-align: center;">1b</td> <td style="text-align: center;">0b</td> <td>Running</td> </tr> <tr> <td style="text-align: center;">1b</td> <td style="text-align: center;">1b</td> <td>Invalid – the HCHalted bit clears immediately</td> </tr> </tbody> </table> <p>Memory read cycles initiated by the EHC that receive any status other than Successful will result in this bit being cleared.</p>	Run/Stop	Halted	Interpretation	0b	0b	In the process of halting	0b	1b	Halted	1b	0b	Running	1b	1b	Invalid – the HCHalted bit clears immediately
Run/Stop	Halted	Interpretation														
0b	0b	In the process of halting														
0b	1b	Halted														
1b	0b	Running														
1b	1b	Invalid – the HCHalted bit clears immediately														

NOTE: The Command Register indicates the command to be executed by the serial bus host controller. Writing to the register causes a command to be executed.



16.2.2.2 USB2.0_STS—USB 2.0 Status Register

Offset: MEM_BASE + 24h–27h Attribute: R/WC, RO
 Default Value: 00001000h Size: 32 bits

This register indicates pending interrupts and various states of the Host controller. The status resulting from a transaction on the serial bus is not indicated in this register. See the Interrupts description in section 4 of the EHCI specification for additional information concerning USB 2.0 interrupt conditions.

Note: For the writable bits, software must write a 1 to clear bits that are set. Writing a 0 has no effect.

Bit	Description
31:16	Reserved
15	<p>Asynchronous Schedule Status — RO. This bit reports the current real status of the Asynchronous Schedule. 0 = Disabled. (Default) 1 = Enabled.</p> <p>NOTE: The Host controller is not required to <i>immediately</i> disable or enable the Asynchronous Schedule when software transitions the <i>Asynchronous Schedule Enable</i> bit (D29:F0, D26:F0:CAPLENGTH + 20h, bit 5) in the USB2.0_CMD register. When this bit and the <i>Asynchronous Schedule Enable</i> bit are the same value, the Asynchronous Schedule is either enabled (1) or disabled (0).</p>
14	<p>Periodic Schedule Status — RO. This bit reports the current real status of the Periodic Schedule. 0 = Disabled. (Default) 1 = Enabled.</p> <p>NOTE: The Host controller is not required to <i>immediately</i> disable or enable the Periodic Schedule when software transitions the <i>Periodic Schedule Enable</i> bit (D29:F0, D26:F0:CAPLENGTH + 20h, bit 4) in the USB2.0_CMD register. When this bit and the <i>Periodic Schedule Enable</i> bit are the same value, the Periodic Schedule is either enabled (1) or disabled (0).</p>
13	<p>Reclamation — RO. This read-only status bit is used to detect an empty asynchronous schedule. The operational model and valid transitions for this bit are described in Section 4 of the EHCI Specification.</p>
12	<p>HCHalted — RO. 0 = This bit is a 0 when the Run/Stop bit is a 1. 1 = The Host controller sets this bit to 1 after it has stopped executing as a result of the Run/Stop bit being set to 0, either by software or by the Host controller hardware (such as, internal error). (Default)</p>
11:6	Reserved
5	<p>Interrupt on Async Advance — R/WC. System software can force the host controller to issue an interrupt the next time the host controller advances the asynchronous schedule by writing a 1 to the <i>Interrupt on Async Advance Doorbell</i> bit (D29:F0, D26:F0:CAPLENGTH + 20h, bit 6) in the USB2.0_CMD register. This bit indicates the assertion of that interrupt source.</p>



Bit	Description
4	<p>Host System Error — R/WC.</p> <p>0 = No serious error occurred during a host system access involving the Host controller module</p> <p>1 = The Host controller sets this bit to 1 when a serious error occurs during a host system access involving the Host controller module. A hardware interrupt is generated to the system. Memory read cycles initiated by the EHC that receive any status other than Successful will result in this bit being set.</p> <p>When this error occurs, the Host controller clears the Run/Stop bit in the USB2.0_CMDregister (D29:F0, D26:F0:CAPLENGTH + 20h, bit 0) to prevent further execution of the scheduled TDs. A hardware interrupt is generated to the system (if enabled in the Interrupt Enable Register).</p>
3	<p>Frame List Rollover — R/WC.</p> <p>0 = No <i>Frame List Index</i> rollover from its maximum value to 0.</p> <p>1 = The Host controller sets this bit to a 1 when the <i>Frame List Index</i> rolls over from its maximum value to 0. Since the PCH only supports the 1024-entry Frame List Size, the <i>Frame List Index</i> rolls over every time FRNUM13 toggles.</p>
2	<p>Port Change Detect — R/WC. This bit is allowed to be maintained in the Auxiliary power well. Alternatively, it is also acceptable that on a D3 to D0 transition of the EHCI HC device, this bit is loaded with the OR of all of the PORTSC change bits (including: Force port resume, overcurrent change, enable/disable change and connect status change). Regardless of the implementation, when this bit is readable (that is, in the D0 state), it must provide a valid view of the Port Status registers.</p> <p>0 = No change bit transition from a 0 to 1 or No Force Port Resume bit transition from 0 to 1 as a result of a J-K transition detected on a suspended port.</p> <p>1 = The Host controller sets this bit to 1 when any port for which the <i>Port Owner</i> bit is set to 0 has a change bit transition from a 0 to 1 or a Force Port Resume bit transition from 0 to 1 as a result of a J-K transition detected on a suspended port.</p>
1	<p>USB Error Interrupt (USBERRINT) — R/WC.</p> <p>0 = No error condition.</p> <p>1 = The Host controller sets this bit to 1 when completion of a USB transaction results in an error condition (such as, error counter underflow). If the TD on which the error interrupt occurred also had its IOC bit set, both this bit and Bit 0 are set. See the EHCI specification for a list of the USB errors that will result in this interrupt being asserted.</p>
0	<p>USB Interrupt (USBINT) — R/WC.</p> <p>0 = No completion of a USB transaction whose Transfer Descriptor had its IOC bit set. No short packet is detected.</p> <p>1 = The Host controller sets this bit to 1 when the cause of an interrupt is a completion of a USB transaction whose Transfer Descriptor had its IOC bit set. The Host controller also sets this bit to 1 when a short packet is detected (actual number of bytes received was less than the expected number of bytes).</p>



16.2.2.3 USB2.0_INTR—USB 2.0 Interrupt Enable Register

Offset: MEM_BASE + 28h–2Bh Attribute: R/W
 Default Value: 00000000h Size: 32 bits

This register enables and disables reporting of the corresponding interrupt to the software. When a bit is set and the corresponding interrupt is active, an interrupt is generated to the host. Interrupt sources that are disabled in this register still appear in the USB2.0_STS Register to allow the software to poll for events. Each interrupt enable bit description indicates whether it is dependent on the interrupt threshold mechanism (see Section 4 of the EHCI specification), or not.

Bit D	Description
31:6	Reserved
5	Interrupt on Async Advance Enable — R/W. 0 = Disable. 1 = Enable. When this bit is a 1, and the Interrupt on Async Advance bit (D29:F0, D26:F0:CAPLENGTH + 24h, bit 5) in the USB2.0_STS register is a 1, the host controller will issue an interrupt at the next interrupt threshold. The interrupt is acknowledged by software clearing the Interrupt on Async Advance bit.
4	Host System Error Enable — R/W. 0 = Disable. 1 = Enable. When this bit is a 1, and the Host System Error Status bit (D29:F0, D26:F0:CAPLENGTH + 24h, bit 4) in the USB2.0_STS register is a 1, the host controller will issue an interrupt. The interrupt is acknowledged by software clearing the Host System Error bit.
3	Frame List Rollover Enable — R/W. 0 = Disable. 1 = Enable. When this bit is a 1, and the Frame List Rollover bit (D29:F0, D26:F0:CAPLENGTH + 24h, bit 3) in the USB2.0_STS register is a 1, the host controller will issue an interrupt. The interrupt is acknowledged by software clearing the Frame List Rollover bit.
2	Port Change Interrupt Enable — R/W. 0 = Disable. 1 = Enable. When this bit is a 1, and the Port Change Detect bit (D29:F0, D26:F0:CAPLENGTH + 24h, bit 2) in the USB2.0_STS register is a 1, the host controller will issue an interrupt. The interrupt is acknowledged by software clearing the Port Change Detect bit.
1	USB Error Interrupt Enable — R/W. 0 = Disable. 1 = Enable. When this bit is a 1, and the USBERRINT bit (D29:F0, D26:F0:CAPLENGTH + 24h, bit 1) in the USB2.0_STS register is a 1, the host controller will issue an interrupt at the next interrupt threshold. The interrupt is acknowledged by software by clearing the USBERRINT bit in the USB2.0_STS register.
0	USB Interrupt Enable — R/W. 0 = Disable. 1 = Enable. When this bit is a 1, and the USBINT bit (D29:F0, D26:F0:CAPLENGTH + 24h, bit 0) in the USB2.0_STS register is a 1, the host controller will issue an interrupt at the next interrupt threshold. The interrupt is acknowledged by software by clearing the USBINT bit in the USB2.0_STS register.

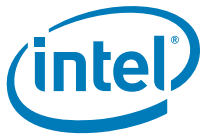

16.2.2.4 FRINDEX—Frame Index Register

Offset: MEM_BASE + 2Ch–2Fh Attribute: R/W
 Default Value: 00000000h Size: 32 bits

The SOF frame number value for the bus SOF token is derived or alternatively managed from this register. Refer to Section 4 of the EHCI specification for a detailed explanation of the SOF value management requirements on the host controller. The value of FRINDEX must be within 125 μ s (1 micro-frame) ahead of the SOF token value. The SOF value may be implemented as an 11-bit shadow register. For this discussion, this shadow register is 11 bits and is named SOFV. SOFV updates every 8 micro-frames (1 millisecond). An example implementation to achieve this behavior is to increment SOFV each time the FRINDEX[2:0] increments from 0 to 1.

Software must use the value of FRINDEX to derive the current micro-frame number, both for high-speed isochronous scheduling purposes and to provide the **get** micro-frame number function required to client drivers. Therefore, the value of FRINDEX and the value of SOFV must be kept consistent if chip is reset or software writes to FRINDEX. Writes to FRINDEX must also **write-through** FRINDEX[13:3] to SOFV[10:0]. In order to keep the update as simple as possible, software should never write a FRINDEX value where the three least significant bits are 111b or 000b.

Note: This register is used by the host controller to index into the periodic frame list. The register updates every 125 microseconds (once each micro-frame). Bits [12:3] are used to select a particular entry in the Periodic Frame List during periodic schedule execution. The number of bits used for the index is fixed at 10 for the PCH since it only supports 1024-entry frame lists. This register must be written as a DWord. Word and byte writes produce undefined results. This register cannot be written unless the Host controller is in the Halted state as indicated by the *HCHalted* bit (D29:F0, D26:F0:CAPLENGTH + 24h, bit 12). A write to this register while the Run/Stop bit (D29:F0, D26:F0:CAPLENGTH + 20h, bit 0) is set to a 1 (USB2.0_CMD register) produces undefined results. Writes to this register also effect the SOF value. See Section 4 of the EHCI specification for details.

Bit De	scription
31:14	Reserved
13:0	Frame List Current Index/Frame Number — R/W. The value in this register increments at the end of each time frame (such as, micro-frame). Bits [12:3] are used for the Frame List current index. This means that each location of the frame list is accessed 8 times (frames or micro-frames) before moving to the next index.



16.2.2.5 CTRLDSSEGMENT—Control Data Structure Segment Register

Offset: MEM_BASE + 30h–33h Attribute: R/W, RO
 Default Value: 00000000h Size: 32 bits

This 32-bit register corresponds to the most significant address bits [63:32] for all EHCI data structures. Since the PCH hardwires the 64-bit Addressing Capability field in HCCPARAMS to 1, this register is used with the link pointers to construct 64-bit addresses to EHCI control data structures. This register is concatenated with the link pointer from either the PERIODICLISTBASE, ASYNCLISTADDR, or any control data structure link field to construct a 64-bit address. This register allows the host software to locate all control data structures within the same 4 GB memory segment.

Bit D	Description
31:12	Upper Address[63:44] — RO. Hardwired to 0s. The PCH EHC is only capable of generating addresses up to 16 terabytes (44 bits of address).
11:0	Upper Address[43:32] — R/W. This 12-bit field corresponds to address bits 43:32 when forming a control data structure address.

16.2.2.6 PERIODICLISTBASE—Periodic Frame List Base Address Register

Offset: MEM_BASE + 34h–37h Attribute: R/W
 Default Value: 00000000h Size: 32 bits

This 32-bit register contains the beginning address of the Periodic Frame List in the system memory. Since the PCH host controller operates in 64-bit mode (as indicated by the 1 in the 64-bit Addressing Capability field in the HCCSPARAMS register) (offset 08h, bit 0), then the most significant 32 bits of every control data structure address comes from the CTRLDSSEGMENT register. HCD loads this register prior to starting the schedule execution by the host controller. The memory structure referenced by this physical memory pointer is assumed to be 4-Kbyte aligned. The contents of this register are combined with the Frame Index Register (FRINDEX) to enable the Host controller to step through the Periodic Frame List in sequence.

Bit	Description
31:12	Base Address (Low) — R/W. These bits correspond to memory address signals [31:12], respectively.
11:0	Reserved



16.2.2.7 ASYNCLISTADDR—Current Asynchronous List Address Register

Offset: MEM_BASE + 38h–3Bh Attribute: R/W
 Default Value: 00000000h Size: 32 bits

This 32-bit register contains the address of the next asynchronous queue head to be executed. Since the PCH host controller operates in 64-bit mode (as indicated by a 1 in 64-bit Addressing Capability field in the HCCPARAMS register) (offset 08h, bit 0), then the most significant 32 bits of every control data structure address comes from the CTRLDSSEGMENT register (offset 08h). Bits [4:0] of this register cannot be modified by system software and will always return 0s when read. The memory structure referenced by this physical memory pointer is assumed to be 32-byte aligned.

Bit	Description
31:5	Link Pointer Low (LPL) — R/W. These bits correspond to memory address signals [31:5], respectively. This field may only reference a Queue Head (QH).
4:0	Reserved

16.2.2.8 CONFIGFLAG—Configure Flag Register

Offset: MEM_BASE + 60h–63h Attribute: R/W
 Default Value: 00000000h Size: 32 bits

This register is in the suspend power well. It is only reset by hardware when the suspend power is initially applied or in response to a host controller reset.

Bit De	scription
31:1	Reserved
0	Configure Flag (CF) — R/W. Host software sets this bit as the last action in its process of configuring the Host controller. This bit controls the default port-routing control logic. Bit values and side-effects are listed below. See Chapter 4 of the EHCI specification for operation details. 0 = Compatibility debug only (default). 1 = Port routing control logic default-routes all ports to this host controller.



16.2.2.9 PORTSC—Port N Status and Control Register

Offset: Port 0 RMH: MEM_BASE + 64h–67h
 Port 1 Debug Port: MEM_BASE + 68–6Bh
 Port 2 USB redirect (if enabled): MEM_BASE + 6C–6Fh

Attribute: R/W, R/WC, RO
 Default Value: 00003000h Size: 32 bits

Note: This register is associated with the upstream ports of the EHCI controller and does not represent downstream hub ports. USB Hub class commands must be used to determine RMH port status and enable test modes. See Chapter 11 of the USB Specification, Revision 2.0 for more details. Rate Matching Hub wake capabilities can be configured by the RMHWKCTL Register (RCBA+35B0h) located in the Chipset Configuration chapter.

A host controller must implement one or more port registers. Software uses the N_Port information from the Structural Parameters Register to determine how many ports need to be serviced. All ports have the structure defined below. Software must not write to unreported Port Status and Control Registers.

This register is in the suspend power well. It is only reset by hardware when the suspend power is initially applied or in response to a host controller reset. The initial conditions of a port are:

- No device connected
- Port disabled.

When a device is attached, the port state transitions to the attached state and system software will process this as with any status change notification. Refer to Section 4 of the EHCI specification for operational requirements for how change events interact with port suspend mode.

Bit D	Description
31:23	Reserved
22	Wake on Overcurrent Enable (WKOC_E) — R/W. 0 = Disable. (Default) 1 = Enable. Writing this bit to a 1 enables the setting of the PME Status bit in the Power Management Control/Status Register (offset 54, bit 15) when the overcurrent Active bit (bit 4 of this register) is set.
21	Wake on Disconnect Enable (WKDSCNNT_E) — R/W. 0 = Disable. (Default) 1 = Enable. Writing this bit to a 1 enables the setting of the PME Status bit in the Power Management Control/Status Register (offset 54, bit 15) when the Current Connect Status changes from connected to disconnected (that is, bit 0 of this register changes from 1 to 0).
20	Wake on Connect Enable (WKCNNNT_E) — R/W. 0 = Disable. (Default) 1 = Enable. Writing this bit to a 1 enables the setting of the PME Status bit in the Power Management Control/Status Register (offset 54, bit 15) when the Current Connect Status changes from disconnected to connected (that is, bit 0 of this register changes from 0 to 1).

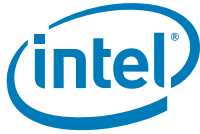

Bit De	scription														
19:16	<p>Port Test Control — R/W. When this field is 0s, the port is NOT operating in a test mode. A non-zero value indicates that it is operating in test mode and the specific test mode is indicated by the specific value. The encoding of the test mode bits are (0110b - 1111b are reserved):</p> <table border="1"> <thead> <tr> <th>Value</th> <th>Maximum Interrupt Interval</th> </tr> </thead> <tbody> <tr> <td>0000b</td> <td>Test mode not enabled (default)</td> </tr> <tr> <td>0001b</td> <td>Test J_STATE</td> </tr> <tr> <td>0010b</td> <td>Test K_STATE</td> </tr> <tr> <td>0011b</td> <td>Test SE0_NAK</td> </tr> <tr> <td>0100b</td> <td>Test Packet</td> </tr> <tr> <td>0101b</td> <td>FORCE_ENABLE</td> </tr> </tbody> </table> <p>Refer to the USB Specification Revision 2.0, Chapter 7 for details on each test mode.</p>	Value	Maximum Interrupt Interval	0000b	Test mode not enabled (default)	0001b	Test J_STATE	0010b	Test K_STATE	0011b	Test SE0_NAK	0100b	Test Packet	0101b	FORCE_ENABLE
Value	Maximum Interrupt Interval														
0000b	Test mode not enabled (default)														
0001b	Test J_STATE														
0010b	Test K_STATE														
0011b	Test SE0_NAK														
0100b	Test Packet														
0101b	FORCE_ENABLE														
15:14	Reserved														
13	<p>Port Owner — R/W. This bit unconditionally goes to a 0 when the Configured Flag bit in the USB2.0_CMD register makes a 0 to 1 transition.</p> <p>System software uses this field to release ownership of the port to a selected host controller (in the event that the attached device is not a high-speed device). Software writes a 1 to this bit when the attached device is not a high-speed device. A 1 in this bit means that a companion host controller owns and controls the port. See Section 4 of the EHCI Specification for operational details.</p>														
12	<p>Port Power (PP) — RO. Read-only with a value of 1. This indicates that the port does have power.</p>														
11:10	<p>Line Status— RO. These bits reflect the current logical levels of the D+ (bit 11) and D- (bit 10) signal lines. These bits are used for detection of low-speed USB devices prior to the port reset and enable sequence. This field is valid only when the port enable bit is 0 and the current connect status bit is set to a 1.</p> <p>00 = SE0 10 = J-state 01 = K-state 11 = Undefined</p>														
9	Reserved														



Bit D	escription														
19:16	<p>Port Test Control — R/W. When this field is 0s, the port is NOT operating in a test mode. A non-zero value indicates that it is operating in test mode and the specific test mode is indicated by the specific value. The encoding of the test mode bits are (0110b – 1111b are reserved):</p> <table border="1" data-bbox="487 441 1055 714"> <thead> <tr> <th>Value</th> <th>Maximum Interrupt Interval</th> </tr> </thead> <tbody> <tr> <td>0000b</td> <td>Test mode not enabled (default)</td> </tr> <tr> <td>0001b</td> <td>Test J_STATE</td> </tr> <tr> <td>0010b</td> <td>Test K_STATE</td> </tr> <tr> <td>0011b</td> <td>Test SE0_NAK</td> </tr> <tr> <td>0100b</td> <td>Test Packet</td> </tr> <tr> <td>0101b</td> <td>FORCE_ENABLE</td> </tr> </tbody> </table> <p>Refer to the USB Specification Revision 2.0, Chapter 7 for details on each test mode.</p>	Value	Maximum Interrupt Interval	0000b	Test mode not enabled (default)	0001b	Test J_STATE	0010b	Test K_STATE	0011b	Test SE0_NAK	0100b	Test Packet	0101b	FORCE_ENABLE
Value	Maximum Interrupt Interval														
0000b	Test mode not enabled (default)														
0001b	Test J_STATE														
0010b	Test K_STATE														
0011b	Test SE0_NAK														
0100b	Test Packet														
0101b	FORCE_ENABLE														
15:14	Reserved														
13	<p>Port Owner — R/W. This bit unconditionally goes to a 0 when the Configured Flag bit in the USB2.0_CMD register makes a 0 to 1 transition.</p> <p>System software uses this field to release ownership of the port to a selected host controller (in the event that the attached device is not a high-speed device). Software writes a 1 to this bit when the attached device is not a high-speed device. A 1 in this bit means that a companion host controller owns and controls the port. See Section 4 of the EHCI Specification for operational details.</p>														
12	<p>Port Power (PP) — RO. Read-only with a value of 1. This indicates that the port does have power.</p>														
11:10	<p>Line Status— RO. These bits reflect the current logical levels of the D+ (bit 11) and D- (bit 10) signal lines. These bits are used for detection of low-speed USB devices prior to the port reset and enable sequence. This field is valid only when the port enable bit is 0 and the current connect status bit is set to a 1.</p> <p>00 = SE0 10 = J-state 01 = K-state 11 = Undefined</p>														
9	Reserved														



Bit Description	Description												
8	<p>Port Reset — R/W. When software writes a 1 to this bit (from a 0), the bus reset sequence as defined in the USB Specification, Revision 2.0 is started. Software writes a 0 to this bit to terminate the bus reset sequence. Software must keep this bit at a 1 long enough to ensure the reset sequence completes as specified in the USB Specification, Revision 2.0.</p> <p>1 = Port is in Reset. 0 = Port is not in Reset.</p> <p>NOTE: When software writes a 0 to this bit, there may be a delay before the bit status changes to a 0. The bit status will not read as a 0 until after the reset has completed. If the port is in high-speed mode after reset is complete, the host controller will automatically enable this port (such as, set the <i>Port Enable</i> bit to a 1). A host controller must terminate the reset and stabilize the state of the port within 2 milliseconds of software transitioning this bit from 0 to 1.</p> <p>For example: if the port detects that the attached device is high-speed during reset, then the host controller must have the port in the enabled state within 2 ms of software writing this bit to a 0. The <i>HCHalted</i> bit (D29:F0, D26:F0:CAPLENGTH + 24h, bit 12) in the <i>USB2.0_STS</i> register should be a 0 before software attempts to use this bit. The host controller may hold <i>Port Reset</i> asserted to a 1 when the <i>HCHalted</i> bit is a 1. This bit is 0 if <i>Port Power</i> is 0</p> <p>NOTE: System software should not attempt to reset a port if the <i>HCHalted</i> bit in the <i>USB2.0_STS</i> register is a 1. Doing so will result in undefined behavior.</p>												
7	<p>Suspend — R/W.</p> <p>0 = Port not in suspend state.(Default) 1 = Port in suspend state.</p> <p>Port Enabled Bit and Suspend bit of this register define the port states as follows:</p> <table border="1" data-bbox="479 1119 954 1266"> <thead> <tr> <th>Port Enabled</th> <th>Suspend</th> <th>Port State</th> </tr> </thead> <tbody> <tr> <td>0</td> <td>X</td> <td>Disabled</td> </tr> <tr> <td>1</td> <td>0</td> <td>Enabled</td> </tr> <tr> <td>1</td> <td>1</td> <td>Suspend</td> </tr> </tbody> </table> <p>When in suspend state, downstream propagation of data is blocked on this port, except for port reset. Note that the bit status does not change until the port is suspended and that there may be a delay in suspending a port depending on the activity on the port. The host controller will unconditionally set this bit to a 0 when software sets the <i>Force Port Resume</i> bit to a 0 (from a 1). A write of 0 to this bit is ignored by the host controller.</p> <p>If host software sets this bit to a 1 when the port is not enabled (that is, <i>Port enabled</i> bit is a 0), the results are undefined.</p>	Port Enabled	Suspend	Port State	0	X	Disabled	1	0	Enabled	1	1	Suspend
Port Enabled	Suspend	Port State											
0	X	Disabled											
1	0	Enabled											
1	1	Suspend											



Bit D	Description
6	<p>Force Port Resume — R/W.</p> <p>0 = No resume (K-state) detected/driven on port. (Default) 1 = Resume detected/driven on port. Software sets this bit to a 1 to drive resume signaling. The Host controller sets this bit to a 1 if a J-to-K transition is detected while the port is in the Suspend state. When this bit transitions to a 1 because a J-to-K transition is detected, the Port Change Detect bit (D29:F0, D26:F0:CAPLENGTH + 24h, bit 2) in the USB2.0_STS register is also set to a 1. If software sets this bit to a 1, the host controller must not set the Port Change Detect bit.</p> <p>NOTE: When the EHCI controller owns the port, the resume sequence follows the defined sequence documented in the USB Specification, Revision 2.0. The resume signaling (Full-speed 'K') is driven on the port as long as this bit remains a 1. Software must appropriately time the Resume and set this bit to a 0 when the appropriate amount of time has elapsed. Writing a 0 (from 1) causes the port to return to high-speed mode (forcing the bus below the port into a high-speed idle). This bit will remain a 1 until the port has switched to the high-speed idle.</p>
5	<p>Overcurrent Change — R/WC. The functionality of this bit is not dependent upon the port owner. Software clears this bit by writing a 1 to it.</p> <p>0 = No change. (Default) 1 = There is a change to Overcurrent Active.</p>
4	<p>Overcurrent Active — RO.</p> <p>0 = This port does not have an overcurrent condition. (Default) 1 = This port currently has an overcurrent condition. This bit will automatically transition from 1 to 0 when the over current condition is removed. The PCH automatically disables the port when the overcurrent active bit is 1.</p>
3	<p>Port Enable/Disable Change — R/WC. For the root hub, this bit gets set to a 1 only when a port is disabled due to the appropriate conditions existing at the EOF2 point (See Chapter 11 of the USB Specification for the definition of a port error). This bit is not set due to the Disabled-to-Enabled transition, nor due to a disconnect. Software clears this bit by writing a 1 to it.</p> <p>0 = No change in status. (Default). 1 = Port enabled/disabled status has changed.</p>
2	<p>Port Enabled/Disabled — R/W. Ports can only be enabled by the host controller as a part of the reset and enable. Software cannot enable a port by writing a 1 to this bit. Ports can be disabled by either a fault condition (disconnect event or other fault condition) or by host software. Note that the bit status does not change until the port state actually changes. There may be a delay in disabling or enabling a port due to other host controller and bus events.</p> <p>0 = Disable 1 = Enable (Default)</p>
1	<p>Connect Status Change — R/WC. This bit indicates a change has occurred in the port's Current Connect Status. Software sets this bit to 0 by writing a 1 to it.</p> <p>0 = No change (Default). 1 = Change in Current Connect Status. The host controller sets this bit for all changes to the port device connect status, even if system software has not cleared an existing connect status change. For example, the insertion status changes twice before system software has cleared the changed condition, hub hardware will be "setting" an already-set bit (that is, the bit will remain set).</p>
0	<p>Current Connect Status — RO. This value reflects the current state of the port, and may not correspond directly to the event that caused the Connect Status Change bit (Bit 1) to be set.</p> <p>0 = No device is present. (Default) 1 = Device is present on port.</p>



16.2.3 USB 2.0-Based Debug Port Registers

The Debug port's registers are located in the same memory area, defined by the Base Address Register (MEM_BASE), as the standard EHCI registers. The base offset for the debug port registers (A0h) is declared in the Debug Port Base Offset Capability Register at Configuration offset 5Ah (D29:F0, D26:F0:offset 5Ah). The specific EHCI port that supports this debug capability (Port 1 for D29:F0 and Port 9 for D26:F0) is indicated by a 4-bit field (bits 20–23) in the HCSPARAMS register of the EHCI controller. The address map of the Debug Port registers is shown in Table 16-4.

Table 16-4. Debug Port Register Address Map

MEM_BASE + Offset	Mnemonic	Register Name	Default	Attribute
A0–A3h	CNTL_STS	Control/Status	00000000h	R/W, R/WC, RO
A4–A7h	USBPID	USB PIDs	00000000h	R/W, RO
A8–AFh	DATABUF[7:0]	Data Buffer (Bytes 7:0)	00000000 00000000h	R/W
B0–B3h	CONFIG	Configuration	00007F01h	R/W

NOTES:

1. All of these registers are implemented in the core well and reset by PLTRST#, EHC HCRESET, and a EHC D3-to-D0 transition.
2. The hardware associated with this register provides no checks to ensure that software programs the interface correctly. How the hardware behaves when programmed improperly is undefined.



16.2.3.1 CNTL_STS—Control/Status Register

Offset: MEM_BASE + A0h Attribute: R/W, R/WC, RO
 Default Value: 00000000h Size: 32 bits

Bit	Description
31	Reserved
30	OWNER_CNT — R/W. 0 = Ownership of the debug port is NOT forced to the EHCI controller (Default) 1 = Ownership of the debug port is forced to the EHCI controller (that is, immediately taken away from the companion Classic USB Host controller) If the port was already owned by the EHCI controller, then setting this bit has no effect. This bit overrides all of the ownership-related bits in the standard EHCI registers.
29	Reserved
28	ENABLED_CNT — R/W. 0 = Software can clear this by writing a 0 to it. The hardware clears this bit for the same conditions where the Port Enable/Disable Change bit (in the PORTSC register) is set. (Default) 1 = Debug port is enabled for operation. Software can directly set this bit if the port is already enabled in the associated PORTSC register (this is enforced by the hardware).
27:17	Reserved
16	DONE_STS — R/WC. Software can clear this by writing a 1 to it. 0 = Request Not complete 1 = Set by hardware to indicate that the request is complete.
15:12	LINK_ID_STS — RO. This field identifies the link interface. 0h = Hardwired. Indicates that it is a USB Debug Port.
11	Reserved
10	IN_USE_CNT — R/W. Set by software to indicate that the port is in use. Cleared by software to indicate that the port is free and may be used by other software. This bit is cleared after reset. (This bit has no affect on hardware.)
9:7	EXCEPTION_STS — RO. This field indicates the exception when the ERROR_GOOD#_STS bit is set. This field should be ignored if the ERROR_GOOD#_STS bit is 0. 000 =No Error. (Default) Note: This should not be seen since this field should only be checked if there is an error. 001 =Transaction error: Indicates the USB 2.0 transaction had an error (CRC, bad PID, timeout, etc.) 010 =Hardware error. Request was attempted (or in progress) when port was suspended or reset. All Other combinations are reserved
6	ERROR_GOOD#_STS — RO. 0 = Hardware clears this bit to 0 after the proper completion of a read or write. (Default) 1 = Error has occurred. Details on the nature of the error are provided in the Exception field.

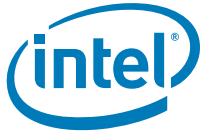

Bit	Description
5	GO_CNT — R/W. 0 = Hardware clears this bit when hardware sets the DONE_STS bit. (Default) 1 = Causes hardware to perform a read or write request. NOTE: Writing a 1 to this bit when it is already set may result in undefined behavior.
4	WRITE_READ#_CNT — R/W. Software clears this bit to indicate that the current request is a read. Software sets this bit to indicate that the current request is a write. 0 = Read (Default) 1 = Write
3:0	DATA_LEN_CNT — R/W. This field is used to indicate the size of the data to be transferred. default = 0h. For write operations, this field is set by software to indicate to the hardware how many bytes of data in Data Buffer are to be transferred to the console. A value of 0h indicates that a zero-length packet should be sent. A value of 1–8 indicates 1–8 bytes are to be transferred. Values 9–Fh are invalid and how hardware behaves if used is undefined. For read operations, this field is set by hardware to indicate to software how many bytes in Data Buffer are valid in response to a read operation. A value of 0h indicates that a zero length packet was returned and the state of Data Buffer is not defined. A value of 1–8 indicates 1–8 bytes were received. Hardware is not allowed to return values 9–Fh. The transferring of data always starts with byte 0 in the data area and moves toward byte 7 until the transfer size is reached.

NOTES:

1. Software should do Read-Modify-Write operations to this register to preserve the contents of bits not being modified. This include Reserved bits.
2. To preserve the usage of RESERVED bits in the future, software should always write the same value read from the bit until it is defined. Reserved bits will always return 0 when read.



16.2.3.2 USBPID—USB PIDs Register

Offset: MEM_BASE + A4h–A7h Attribute: R/W, RO
 Default Value: 00000000h Size: 32 bits

This Dword register is used to communicate PID information between the USB debug driver and the USB debug port. The debug port uses some of these fields to generate USB packets, and uses other fields to return PID information to the USB debug driver.

Bit	Description
31:24	Reserved
23:16	RECEIVED_PID_STS[23:16] — RO. Hardware updates this field with the received PID for transactions in either direction. When the controller is writing data, this field is updated with the handshake PID that is received from the device. When the host controller is reading data, this field is updated with the data packet PID (if the device sent data), or the handshake PID (if the device NAKs the request). This field is valid when the hardware clears the GO_DONE#_CNT bit.
15:8	SEND_PID_CNT[15:8] — R/W. Hardware sends this PID to begin the data packet when sending data to USB (that is, WRITE_READ#_CNT is asserted). Software typically sets this field to either DATA0 or DATA1 PID values.
7:0	TOKEN_PID_CNT[7:0] — R/W. Hardware sends this PID as the Token PID for each USB transaction. Software typically sets this field to either IN, OUT, or SETUP PID values.

16.2.3.3 DATABUF[7:0]—Data Buffer Bytes[7:0] Register

Offset: MEM_BASE + A8h–AFh Attribute: R/W
 Default Value: 0000000000000000h Size: 64 bits

This register can be accessed as 8 separate 8-bit registers or 2 separate 32-bit register.

Bit	Description
63:0	DATABUFFER[63:0] — R/W. This field is the 8 bytes of the data buffer. Bits 7:0 correspond to least significant byte (byte 0). Bits 63:56 correspond to the most significant byte (byte 7). The bytes in the Data Buffer must be written with data before software initiates a write request. For a read request, the Data Buffer contains valid data when DONE_STS bit (offset A0, bit 16) is cleared by the hardware, ERROR_GOOD#_STS (offset A0, bit 6) is cleared by the hardware, and the DATA_LENGTH_CNT field (offset A0, bits 3:0) indicates the number of bytes that are valid.

16.2.3.4 CONFIG—Configuration Register

Offset: MEM_BASE + B0–B3h Attribute: R/W
 Default Value: 00007F01h Size: 32 bits

Bit	Description
31:15	Reserved
14:8	USB_ADDRESS_CNF — R/W. This 7-bit field identifies the USB device address used by the controller for all Token PID generation. (Default = 7Fh)
7:4	Reserved
3:0	USB_ENDPOINT_CNF — R/W. This 4-bit field identifies the endpoint used by the controller for all Token PID generation. (Default = 1h)



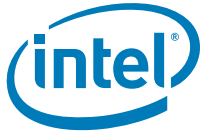



17 Integrated Intel® High Definition Audio Controller Registers

17.1 Intel® High Definition Audio Controller Registers (D27:F0)

The Intel® High Definition Audio controller resides in PCI Device 27, Function 0 on bus 0. This function contains a set of DMA engines that are used to move samples of digitally encoded data between system memory and external codecs.

Note: All registers in this function (including memory-mapped registers) must be addressable in byte, word, and DWord quantities. The software must always make register accesses on natural boundaries (that is, DWord accesses must be on DWord boundaries; word accesses on word boundaries, and so on). Register access crossing the DWord boundary are ignored. In addition, the memory-mapped register space must not be accessed with the LOCK semantic exclusive-access mechanism. If software attempts exclusive-access mechanisms to the Intel® High Definition Audio memory-mapped space, the results are undefined.

Note: Users interested in providing feedback on the Intel® High Definition Audio specification or planning to implement the Intel® High Definition Audio specification into a future product will need to execute the *Intel® High Definition Audio Specification Developer's Agreement*. For more information, contact nextgenaudio@intel.com.

17.1.1 Intel® High Definition Audio PCI Configuration Space (Intel® High Definition Audio— D27:F0)

Note: Address locations that are not shown should be treated as Reserved.

Table 17-1. Intel® High Definition Audio PCI Register Address Map (Intel® High Definition Audio D27:F0) (Sheet 1 of 3)

Offset	Mnemonic	Register Name	Default	Attribute
00h–01h	VID	Vendor Identification	8086h	RO
02h–03h	DID	Device Identification	See register description	RO
04h–05h	PCICMD	PCI Command	0000h	R/W, RO
06h–07h	PCISTS	PCI Status	0010h	R/WC, RO
08h	RID	Revision Identification	See register description	RO
09h	PI	Programming Interface	00h	RO
0Ah	SCC	Sub Class Code	03h	RO
0Bh	BCC	Base Class Code	04h	RO
0Ch	CLS	Cache Line Size	00h	R/W
0Dh	LT	Latency Timer	00h	RO
0Eh	HEADTYP	Header Type	00h	RO

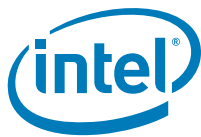

Table 17-1. Intel® High Definition Audio PCI Register Address Map (Intel® High Definition Audio D27:F0) (Sheet 2 of 3)

Offset	Mnemonic	Register Name	Default	Attribute
10h–13h	HDBARL	Intel® High Definition Audio Lower Base Address (Memory)	00000004h	R/W, RO
14h–17h	HDBARU	Intel® High Definition Audio Upper Base Address (Memory)	00000000h	R/W
2Ch–2Dh	SVID	Subsystem Vendor Identification	0000h	R/WO
2Eh–2Fh	SID	Subsystem Identification	0000h	R/WO
34h	CAPPTR	Capability List Pointer	50h	RO
3Ch	INTLN	Interrupt Line	00h	R/W
3Dh	INTPN	Interrupt Pin	See Register Description	RO
40h	HDCTL	Intel® High Definition Audio Control	01h	R/W, RO
43h	HDINIT1	Intel® High Definition Audio Initialization Register 1	07h	RO
4Ch	DCKCTL	Docking Control (Mobile Only)	00h	R/W, RO
4Dh	DCKSTS	Docking Status (Mobile Only)	80h	R/WO, RO
50h–51h	PID	PCI Power Management Capability ID	6001h	R/WO, RO
52h–53h	PC	Power Management Capabilities	C842h	RO
54h–57h	PCS	Power Management Control and Status	00000000h	R/W, RO, R/WC
60h–61h	MID	MSI Capability ID	7005h	RO
62h–63h	MMC	MSI Message Control	0080h	R/W, RO
64h–67h	MMLA	MSI Message Lower Address	00000000h	R/W, RO
68h–6Bh	MMUA	MSI Message Upper Address	00000000h	R/W
6Ch–6Dh	MMD	MSI Message Data	0000h	R/W
70h–71h	PXID	PCI Express* Capability Identifiers	0010h	RO
72h–73h	PXC	PCI Express Capabilities	0091h	RO
74h–77h	DEVCAP	Device Capabilities	10000000h	RO, R/WO
78h–79h	DEVC	Device Control	0800h	R/W, RO
7Ah–7Bh	DEVS	Device Status	0010h	RO
100h–103h	VCCAP	Virtual Channel Enhanced Capability Header	13010002h	R/WO
104h–107h	PVCCAP1	Port VC Capability Register 1	00000001h	RO
108h–10Bh	PVCCAP2	Port VC Capability Register 2	00000000h	RO
10Ch–10D	PVCCTL	Port VC Control	0000h	RO
10Eh–10Fh	PVCSTS	Port VC Status	0000h	RO
110h–113h	VC0CAP	VC0 Resource Capability	00000000h	RO
114h–117h	VC0CTL	VC0 Resource Control	800000FFh	R/W, RO
11Ah–11Bh	VC0STS	VC0 Resource Status	0000h	RO
11Ch–11Fh	VCiCAP	VCi Resource Capability	00000000h	RO

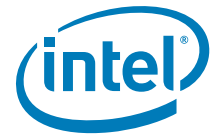

Table 17-1. Intel® High Definition Audio PCI Register Address Map (Intel® High Definition Audio D27:F0) (Sheet 3 of 3)

Offset	Mnemonic	Register Name	Default	Attribute
120h–123h	VCICTL	VCi Resource Control	00000000h	R/W, RO
126h–127h	VCISTS	VCi Resource Status	0000h	RO
130h–133h	RCCAP	Root Complex Link Declaration Enhanced Capability Header	00010005h	RO
134h–137h	ESD	Element Self Description	0F000100h	RO
140h–143h	L1DESC	Link 1 Description	00000001h	RO
148h–14Bh	L1ADDL	Link 1 Lower Address	See Register Description	RO
14Ch–14Fh	L1ADDU	Link 1 Upper Address	00000000h	RO

17.1.1.1 VID—Vendor Identification Register (Intel® High Definition Audio Controller—D27:F0)

Offset: 00h–01h Attribute: RO
 Default Value: 8086h Size: 16 bits

Bit	Description
15:0	Vendor ID — RO. This is a 16-bit value assigned to Intel. Intel VID = 8086h

17.1.1.2 DID—Device Identification Register (Intel® High Definition Audio Controller—D27:F0)

Offset Address: 02h–03h Attribute: RO
 Default Value: See bit description Size: 16 bits

Bit	Description
15:0	Device ID — RO. This is a 16-bit value assigned to the PCH’s Intel® High Definition Audio controller. See the <i>Intel® 6 Series Chipset and Intel® C200 Series Chipset Specification Update</i> for the value of the DID Register.



17.1.1.3 PCICMD—PCI Command Register (Intel® High Definition Audio Controller—D27:F0)

Offset Address: 04h–05h
Default Value: 0000h

Attribute: R/W, RO
Size: 16 bits

Bit	Description
15:11	Reserved
10	Interrupt Disable (ID) — R/W. 0= The INTx# signals may be asserted. 1= The Intel® High Definition Audio controller's INTx# signal will be deasserted. NOTE: This bit does not affect the generation of MSIs.
9	Fast Back to Back Enable (FBE) — RO. Hardwired to 0.
8	SERR# Enable (SERR_EN) — R/W. SERR# is not generated by the PCH Intel® High Definition Audio Controller.
7	Wait Cycle Control (WCC) — RO. Hardwired to 0.
6	Parity Error Response (PER) — R/W. PER functionality not implemented.
5	VGA Palette Snoop (VPS) — RO. Hardwired to 0.
4	Memory Write and Invalidate Enable (MWIE) — RO. Hardwired to 0.
3	Special Cycle Enable (SCE) — RO. Hardwired to 0.
2	Bus Master Enable (BME) — R/W. Controls standard PCI Express* bus mastering capabilities for Memory and I/O, reads and writes. Note that this bit also controls MSI generation since MSI's are essentially Memory writes. 0 = Disable 1 = Enable
1	Memory Space Enable (MSE) — R/W. Enables memory space addresses to the Intel® High Definition Audio controller. 0 = Disable 1 = Enable
0	I/O Space Enable (IOSE)—RO. Hardwired to 0 since the Intel® High Definition Audio controller does not implement I/O space.



17.1.1.4 PCISTS—PCI Status Register (Intel® High Definition Audio Controller—D27:F0)

Offset Address: 06h–07h Attribute: RO, R/WC
 Default Value: 0010h Size: 16 bits

Bit	Description
15	Detected Parity Error (DPE) — RO. Hardwired to 0.
14	SERR# Status (SERRS) — RO. Hardwired to 0.
13	Received Master Abort (RMA) — R/WC. Software clears this bit by writing a 1 to it. 0 = No master abort received. 1 = The Intel® High Definition Audio controller sets this bit when, as a bus master, it receives a master abort. When set, the Intel® High Definition Audio controller clears the run bit for the channel that received the abort.
12	Received Target Abort (RTA) — RO. Hardwired to 0.
11	Signaled Target Abort (STA) — RO. Hardwired to 0.
10:9	DEVSEL# Timing Status (DEV_STS) — RO. Hardwired to 0.
8	Data Parity Error Detected (DPED) — RO. Hardwired to 0.
7	Fast Back to Back Capable (FB2BC) — RO. Hardwired to 0.
6	Reserved
5	66 MHz Capable (66MHZ_CAP) — RO. Hardwired to 0.
4	Capabilities List (CAP_LIST) — RO. Hardwired to 1. Indicates that the controller contains a capabilities pointer list. The first item is pointed to by looking at configuration offset 34h.
3	Interrupt Status (IS) — RO. 0 = This bit is 0 after the interrupt is cleared. 1 = This bit is 1 when the INTx# is asserted. Note that this bit is not set by an MSI.
2:0	Reserved

17.1.1.5 RID—Revision Identification Register (Intel® High Definition Audio Controller—D27:F0)

Offset: 08h Attribute: RO
 Default Value: See bit description Size: 8 Bits

Bit	Description
7:0	Revision ID — RO. See the <i>Intel® 6 Series Chipset and Intel® C200 Series Chipset Specification Update</i> for the value of the RID Register.

17.1.1.6 PI—Programming Interface Register (Intel® High Definition Audio Controller—D27:F0)

Offset: 09h Attribute: RO
 Default Value: 00h Size: 8 bits

Bit	Description
7:0	Programming Interface — RO.

**17.1.1.7 SCC—Sub Class Code Register
(Intel® High Definition Audio Controller—D27:F0)**

Address Offset: 0Ah Attribute: RO
Default Value: 03h Size: 8 bits

Bit	Description
7:0	Sub Class Code (SCC) — RO. 03h = Audio Device

**17.1.1.8 BCC—Base Class Code Register
(Intel® High Definition Audio Controller—D27:F0)**

Address Offset: 0Bh Attribute: RO
Default Value: 04h Size: 8 bits

Bit	Description
7:0	Base Class Code (BCC) — RO. 04h = Multimedia device

**17.1.1.9 CLS—Cache Line Size Register
(Intel® High Definition Audio Controller—D27:F0)**

Address Offset: 0Ch Attribute: R/W
Default Value: 00h Size: 8 bits

Bit	Description
7:0	Cache Line Size — R/W. Implemented as R/W register, but has no functional impact to the PCH

**17.1.1.10 LT—Latency Timer Register
(Intel® High Definition Audio Controller—D27:F0)**

Address Offset: 0Dh Attribute: RO
Default Value: 00h Size: 8 bits

Bit	Description
7:0	Latency Timer — RO. Hardwired to 00

**17.1.1.11 HEADTYP—Header Type Register
(Intel® High Definition Audio Controller—D27:F0)**

Address Offset: 0Eh Attribute: RO
Default Value: 00h Size: 8 bits

Bit	Description
7:0	Header Type — RO. Hardwired to 00.



17.1.1.12 HDBARL—Intel® High Definition Audio Lower Base Address Register (Intel® High Definition Audio—D27:F0)

Address Offset: 10h–13h Attribute: R/W, RO
 Default Value: 00000004h Size: 32 bits

Bit	Description
31:14	Lower Base Address (LBA) — R/W. Base address for the Intel® High Definition Audio controller's memory mapped configuration registers. 16 Kbytes are requested by hardwiring bits 13:4 to 0s.
13:4	Reserved
3	Prefetchable (PREF) — RO. Hardwired to 0 to indicate that this BAR is NOT prefetchable
2:1	Address Range (ADDRNG) — RO. Hardwired to 10b, indicating that this BAR can be located anywhere in 64-bit address space.
0	Space Type (SPTYP) — RO. Hardwired to 0. Indicates this BAR is located in memory space.

17.1.1.13 HDBARU—Intel® High Definition Audio Upper Base Address Register (Intel® High Definition Audio Controller—D27:F0)

Address Offset: 14h–17h Attribute: R/W
 Default Value: 00000000h Size: 32 bits

Bit	Description
31:0	Upper Base Address (UBA) — R/W. Upper 32 bits of the Base address for the Intel® High Definition Audio controller's memory mapped configuration registers.

17.1.1.14 SVID—Subsystem Vendor Identification Register (Intel® High Definition Audio Controller—D27:F0)

Address Offset: 2Ch–2Dh Attribute: R/WO
 Default Value: 0000h Size: 16 bits
 Function Level Reset: No

The SVID register, in combination with the Subsystem ID register (D27:F0:2Eh), enable the operating environment to distinguish one audio subsystem from the other(s).

This register is implemented as write-once register. Once a value is written to it, the value can be read back. Any subsequent writes will have no effect.

This register is not affected by the D3_{HOT} to D0 transition.

Bit	Description
15:0	Subsystem Vendor ID — R/WO.

**17.1.1.15 SID—Subsystem Identification Register (Intel® High Definition Audio Controller—D27:F0)**

Address Offset:	2Eh–2Fh	Attribute:	R/WO
Default Value:	0000h	Size:	16 bits
Function Level Reset:	No		

The SID register, in combination with the Subsystem Vendor ID register (D27:F0:2Ch) make it possible for the operating environment to distinguish one audio subsystem from the other(s).

This register is implemented as write-once register. Once a value is written to it, the value can be read back. Any subsequent writes will have no effect.

This register is not affected by the D3_{HOT} to D0 transition.

Bit	Description
15:0	Subsystem ID — R/WO.

17.1.1.16 CAPPTR—Capabilities Pointer Register (Intel® High Definition Audio Controller—D27:F0)

Address Offset:	34h	Attribute:	RO
Default Value:	50h	Size:	8 bits

This register indicates the offset for the capability pointer.

Bit	Description
7:0	Capabilities Pointer (CAP_PTR) — RO. This field indicates that the first capability pointer offset is offset 50h (Power Management Capability).

17.1.1.17 INTLN—Interrupt Line Register (Intel® High Definition Audio Controller—D27:F0)

Address Offset:	3Ch	Attribute:	R/W
Default Value:	00h	Size:	8 bits
Function Level Reset:	No		

Bit	Description
7:0	Interrupt Line (INT_LN) — R/W. This data is not used by the PCH. It is used to communicate to software the interrupt line that the interrupt pin is connected to.

17.1.1.18 INTPN—Interrupt Pin Register (Intel® High Definition Audio Controller—D27:F0)

Address Offset:	3Dh	Attribute:	RO
Default Value:	See Description	Size:	8 bits

Bit	Description
7:4	Reserved
3:0	Interrupt Pin (IP) — RO. This reflects the value of D27IP.ZIP (Chipset Config Registers:Offset 3110h:bits 3:0).



17.1.1.22 DCKSTS—Docking Status Register (Mobile Only) (Intel® High Definition Audio Controller—D27:F0)

Address Offset: 4Dh Attribute: R/WO, RO
Default Value: 80h Size: 8 bits
Function Level Reset: No

Bit	Description
7	Docking Supported (DS) — R/WO: A 1 indicates that PCH supports HD Audio Docking. The DCKCTL.DA bit is only writable when this DS bit is 1. ACPI BIOS software should only branch to the docking routine when this DS bit is 1. BIOS may clear this bit to 0 to prohibit the ACPI BIOS software from attempting to run the docking routines. Note that this bit is reset to its default value only on a PLTRST#, but not on a CRST# or D3hot-to-D0 transition.
6:1	Reserved
0	Dock Mated (DM) — RO: This bit effectively communicates to software that an Intel® HD Audio docked codec is physically and electrically attached. Controller hardware sets this bit to 1 after the docking sequence triggered by writing a 1 to the Dock Attach (GCTL.DA) bit is completed (HDA_DOCK_RST# deassertion). This bit indicates to software that the docked codec(s) may be discovered using the STATESTS register and then enumerated. Controller hardware sets this bit to 0 after the undocking sequence triggered by writing a 0 to the Dock Attach (GCTL.DA) bit is completed (HDA_DOCK_EN# deasserted). This bit indicates to software that the docked codec(s) may be physically undocked.

17.1.1.23 PID—PCI Power Management Capability ID Register (Intel® High Definition Audio Controller—D27:F0)

Address Offset: 50h–51h Attribute: R/WO, RO
Default Value: 6001h Size: 16 bits
Function Level Reset: No (Bits 7:0 only)

Bit	Description
15:8	Next Capability (Next) — R/WO. Points to the next capability structure (MSI).
7:0	Cap ID (CAP) — RO. Hardwired to 01h. Indicates that this pointer is a PCI power management capability. These bits are not reset by Function Level Reset.



17.1.1.24 PC—Power Management Capabilities Register (Intel® High Definition Audio Controller—D27:F0)

Address Offset: 52h–53h Attribute: RO
 Default Value: C842h Size: 16 bits

Bit	Description
15:11	PME Support — RO. Hardwired to 11001b. Indicates PME# can be generated from D3 and D0 states.
10	D2 Support — RO. Hardwired to 0. Indicates that D2 state is not supported.
9	D1 Support —RO. Hardwired to 0. Indicates that D1 state is not supported.
8:6	Aux Current — RO. Hardwired to 001b. Reports 55 mA maximum suspend well current required when in the D3 _{COLD} state.
5	Device Specific Initialization (DSI) — RO. Hardwired to 0. Indicates that no device specific initialization is required.
4	Reserved
3	PME Clock (PMEC) — RO. Does not apply. Hardwired to 0.
2:0	Version — RO. Hardwired to 010b. Indicates support for version 1.1 of the PCI Power Management Specification.

17.1.1.25 PCS—Power Management Control and Status Register (Intel® High Definition Audio Controller—D27:F0)

Address Offset: 54h–57h Attribute: RO, R/W, R/WC
 Default Value: 00000000h Size: 32 bits
 Function Level Reset: No

Bit	Description
31:24	Data — RO. Does not apply. Hardwired to 0.
23	Bus Power/Clock Control Enable — RO. Does not apply. Hardwired to 0.
22	B2/B3 Support — RO. Does not apply. Hardwired to 0.
21:16	Reserved
15	PME Status (PMES) — R/WC. 0 = Software clears the bit by writing a 1 to it. 1 = This bit is set when the Intel® High Definition Audio controller would normally assert the PME# signal independent of the state of the PME_EN bit (bit 8 in this register). This bit is in the resume well and is cleared by a power-on reset. Software must not make assumptions about the reset state of this bit and must set it appropriately.
14:9	Reserved
8	PME Enable (PMEE) — R/W. 0 = Disable 1 = When set and if corresponding PMES also set, the Intel® High Definition Audio controller sets the PME_B0_STS bit in the GPE0_STS register (PMBASE +28h). This bit is in the resume well and is cleared on a power-on reset. Software must not make assumptions about the reset state of this bit and must set it appropriately.
7:2	Reserved



Bit	Description
1:0	<p>Power State (PS) — R/W. This field is used both to determine the current power state of the Intel® High Definition Audio controller and to set a new power state.</p> <p>00 = D0 state 11 = D3_{HOT} state Others = reserved</p> <p>NOTES:</p> <ol style="list-style-type: none"> 1. If software attempts to write a value of 01b or 10b in to this field, the write operation must complete normally; however, the data is discarded and no state change occurs. 2. When in the D3_{HOT} states, the Intel® High Definition Audio controller's configuration space is available, but the IO and memory space are not. Additionally, interrupts are blocked. 3. When software changes this value from D3_{HOT} state to the D0 state, an internal warm (soft) reset is generated, and software must re-initialize the function.

17.1.1.26 MID—MSI Capability ID Register (Intel® High Definition Audio Controller—D27:F0)

Address Offset: 60h–61h Attribute: RO
 Default Value: 7005h Size: 16 bits

Bit	Description
15:8	Next Capability (Next) — RO. Hardwired to 70h. Points to the PCI Express* capability structure.
7:0	Cap ID (CAP) — RO. Hardwired to 05h. Indicates that this pointer is a MSI capability.

17.1.1.27 MMC—MSI Message Control Register (Intel® High Definition Audio Controller—D27:F0)

Address Offset: 62h–63h Attribute: RO, R/W
 Default Value: 0080h Size: 16 bits

Bit	Description
15:8	Reserved
7	64b Address Capability (64ADD) — RO. Hardwired to 1. Indicates the ability to generate a 64-bit message address.
6:4	Multiple Message Enable (MME) — RO. Normally this is a R/W register. However since only 1 message is supported, these bits are hardwired to 000 = 1 message.
3:1	Multiple Message Capable (MMC) — RO. Hardwired to 0 indicating request for 1 message.
0	MSI Enable (ME) — R/W. 0 = an MSI may not be generated 1 = an MSI will be generated instead of an INTx signal.



17.1.1.32 PXC—PCI Express* Capabilities Register (Intel® High Definition Audio Controller—D27:F0)

Address Offset: 72h–73h Attribute: RO
Default Value: 0091h Size: 16 bits

Bit	Description
15:14	Reserved
13:9	Interrupt Message Number (IMN) — RO. Hardwired to 0.
8	Slot Implemented (SI) — RO. Hardwired to 0.
7:4	Device/Port Type (DPT) — RO. Hardwired to 1001b. Indicates that this is a Root Complex Integrated endpoint device.
3:0	Capability Version (CV) — RO. Hardwired to 0001b. Indicates version #1 PCI Express capability

17.1.1.33 DEVCAP—Device Capabilities Register (Intel® High Definition Audio Controller—D27:F0)

Address Offset: 74h–77h Attribute: R/WO, RO
Default Value: 10000000h Size: 32 bits
Function Level Reset: No

Bit	Description
31:29	Reserved
28	Function Level Reset (FLR) — R/WO. A 1 indicates that the PCH HD Audio Controller supports the Function Level Reset Capability.
27:26	Captured Slot Power Limit Scale (SPLS) — RO. Hardwired to 0.
25:18	Captured Slot Power Limit Value (SPLV) — RO. Hardwired to 0.
17:15	Reserved
14	Power Indicator Present — RO. Hardwired to 0.
13	Attention Indicator Present — RO. Hardwired to 0.
12	Attention Button Present — RO. Hardwired to 0.
11:9	Endpoint L1 Acceptable Latency — R/WO.
8:6	Endpoint L0s Acceptable Latency — R/WO.
5	Extended Tag Field Support — RO. Hardwired to 0. Indicates 5-bit tag field support
4:3	Phantom Functions Supported — RO. Hardwired to 0. Indicates that phantom functions not supported.
2:0	Max Payload Size Supported — RO. Hardwired to 0. Indicates 128-B maximum payload size capability.



17.1.1.34 DEVC—Device Control Register (Intel® High Definition Audio Controller—D27:F0)

Address Offset: 78h–79h Attribute: R/W, RO
 Default Value: 0800h Size: 16 bits
 Function Level Reset: No (Bit 11 Only)

Bit	Description
15	Initiate FLR (IF) — R/W. This bit is used to initiate FLR transition. 1 = A write of 1 initiates FLR transition. Since hardware does not respond to any cycles until FLR completion, the read value by software from this bit is 0.
14:12	Max Read Request Size — RO. Hardwired to 0 enabling 128B maximum read request size.
11	No Snoop Enable (NSNPEN) — R/W. 0 = The Intel® High Definition Audio controller will not set the No Snoop bit. In this case, isochronous transfers will not use VC1 (VCi) even if it is enabled since VC1 is never snooped. Isochronous transfers will use VC0. 1 = The Intel® High Definition Audio controller is permitted to set the No Snoop bit in the Requester Attributes of a bus master transaction. In this case, VC0 or VC1 may be used for isochronous transfers. NOTE: This bit is not reset on D3 _{HOT} to D0 transition; however, it is reset by PLTRST#. This bit is not reset by Function Level Reset.
10	Auxiliary Power Enable — RO. Hardwired to 0, indicating that Intel® High Definition Audio device does not draw AUX power
9	Phantom Function Enable — RO. Hardwired to 0 disabling phantom functions.
8	Extended Tag Field Enable — RO. Hardwired to 0 enabling 5-bit tag.
7:5	Max Payload Size — RO. Hardwired to 0 indicating 128B.
4	Enable Relaxed Ordering — RO. Hardwired to 0 disabling relaxed ordering.
3	Unsupported Request Reporting Enable — R/W. Not implemented.
2	Fatal Error Reporting Enable — R/W. Not implemented.
1	Non-Fatal Error Reporting Enable — R/W. Not implemented.
0	Correctable Error Reporting Enable — R/W. Not implemented.

**17.1.1.35 DEVS—Device Status Register (Intel® High Definition Audio Controller—D27:F0)**

Address Offset: 7Ah–7Bh Attribute: RO
 Default Value: 0010h Size: 16 bits

Bit	Description
15:6	Reserved
5	Transactions Pending — RO. 0 = Indicates that completions for all non-posted requests have been received 1 = Indicates that Intel® High Definition Audio controller has issued non-posted requests which have not been completed.
4	AUX Power Detected — RO. Hardwired to 1 indicating the device is connected to resume power
3	Unsupported Request Detected — RO. Not implemented. Hardwired to 0.
2	Fatal Error Detected — RO. Not implemented. Hardwired to 0.
1	Non-Fatal Error Detected — RO. Not implemented. Hardwired to 0.
0	Correctable Error Detected — RO. Not implemented. Hardwired to 0.

17.1.1.36 VCCAP—Virtual Channel Enhanced Capability Header (Intel® High Definition Audio Controller—D27:F0)

Address Offset: 100h–103h Attribute: R/WO
 Default Value: 13010002h Size: 32 bits

Bit	Description
31:20	Next Capability Offset — R/WO. Points to the next capability header. 130h = Root Complex Link Declaration Enhanced Capability Header 000h = Root Complex Link Declaration Enhanced Capability Header is not supported.
19:16	Capability Version — R/WO. 0h =PCI Express Virtual channel capability and the Root Complex Topology Capability structure are not supported. 1h =PCI Express Virtual channel capability and the Root Complex Topology Capability structure are supported.
15:0	PCI Express* Extended Capability — R/WO. 0000h =PCI Express Virtual channel capability and the Root Complex Topology Capability structure are not supported. 0002h =PCI Express Virtual channel capability and the Root Complex Topology Capability structure are supported.



17.1.1.37 PVCCAP1—Port VC Capability Register 1 (Intel® High Definition Audio Controller—D27:F0)

Address Offset: 104h–107h Attribute: RO
 Default Value: 00000001h Size: 32 bits

Bit	Description
31:12	Reserved
11:10	Port Arbitration Table Entry Size — RO. Hardwired to 0 since this is an endpoint device.
9:8	Reference Clock — RO. Hardwired to 0 since this is an endpoint device.
7	Reserved
6:4	Low Priority Extended VC Count — RO. Hardwired to 0. Indicates that only VC0 belongs to the low priority VC group.
3	Reserved
2:0	Extended VC Count — RO. Hardwired to 001b. Indicates that 1 extended VC (in addition to VC0) is supported by the Intel® High Definition Audio controller.

17.1.1.38 PVCCAP2 — Port VC Capability Register 2 (Intel® High Definition Audio Controller—D27:F0)

Address Offset: 108h–10Bh Attribute: RO
 Default Value: 00000000h Size: 32 bits

Bit	Description
31:24	VC Arbitration Table Offset — RO. Hardwired to 0 indicating that a VC arbitration table is not present.
23:8	Reserved
7:0	VC Arbitration Capability — RO. Hardwired to 0. These bits are not applicable since the Intel® High Definition Audio controller reports a 0 in the Low Priority Extended VC Count bits in the PVCCAP1 register.

17.1.1.39 PVCCTL — Port VC Control Register (Intel® High Definition Audio Controller—D27:F0)

Address Offset: 10Ch–10Dh Attribute: RO
 Default Value: 0000h Size: 16 bits

Bit	Description
15:4	Reserved
3:1	VC Arbitration Select — RO. Hardwired to 0. Normally these bits are R/W. However, these bits are not applicable since the Intel® High Definition Audio controller reports a 0 in the Low Priority Extended VC Count bits in the PVCCAP1 register.
0	Load VC Arbitration Table — RO. Hardwired to 0 since an arbitration table is not present.



17.1.1.40 PVCSTS—Port VC Status Register (Intel® High Definition Audio Controller—D27:F0)

Address Offset: 10Eh–10Fh Attribute: RO
Default Value: 0000h Size: 16 bits

Bit	Description
15:1	Reserved
0	VC Arbitration Table Status — RO. Hardwired to 0 since an arbitration table is not present.

17.1.1.41 VC0CAP—VC0 Resource Capability Register (Intel® High Definition Audio Controller—D27:F0)

Address Offset: 110h–113h Attribute: RO
Default Value: 00000000h Size: 32 bits

Bit	Description
31:24	Port Arbitration Table Offset — RO. Hardwired to 0 since this field is not valid for endpoint devices
23	Reserved
22:16	Maximum Time Slots — RO. Hardwired to 0 since this field is not valid for endpoint devices.
15	Reject Snoop Transactions — RO. Hardwired to 0 since this field is not valid for endpoint devices.
14	Advanced Packet Switching — RO. Hardwired to 0 since this field is not valid for endpoint devices.
13:8	Reserved
7:0	Port Arbitration Capability — RO. Hardwired to 0 since this field is not valid for endpoint devices.

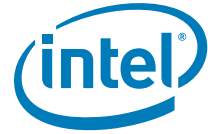

17.1.1.42 VC0CTL—VC0 Resource Control Register (Intel® High Definition Audio Controller—D27:F0)

Address Offset: 114h–117h Attribute: R/W, RO
 Default Value: 800000FFh Size: 32 bits
 Function Level Reset: No

Bit	Description
31	VC0 Enable — RO. Hardwired to 1 for VC0.
30:27	Reserved
26:24	VC0 ID — RO. Hardwired to 0 since the first VC is always assigned as VC0.
23:20	Reserved
19:17	Port Arbitration Select — RO. Hardwired to 0 since this field is not valid for endpoint devices.
16	Load Port Arbitration Table — RO. Hardwired to 0 since this field is not valid for endpoint devices.
15:8	Reserved
7:0	TC/VC0 Map — R/W, RO. Bit 0 is hardwired to 1 since TC0 is always mapped VC0. Bits [7:1] are implemented as R/W bits.

17.1.1.43 VC0STS—VC0 Resource Status Register (Intel® High Definition Audio Controller—D27:F0)

Address Offset: 11Ah–11Bh Attribute: RO
 Default Value: 0000h Size: 16 bits

Bit	Description
15:2	Reserved
1	VC0 Negotiation Pending — RO. Hardwired to 0 since this bit does not apply to the integrated Intel® High Definition Audio device.
0	Port Arbitration Table Status — RO. Hardwired to 0 since this field is not valid for endpoint devices.



17.1.1.44 VCI_{CAP}—VCI Resource Capability Register (Intel® High Definition Audio Controller—D27:F0)

Address Offset: 11Ch–11Fh Attribute: RO
 Default Value: 00000000h Size: 32 bits

Bit	Description
31:24	Port Arbitration Table Offset — RO. Hardwired to 0 since this field is not valid for endpoint devices.
23	Reserved
22:16	Maximum Time Slots — RO. Hardwired to 0 since this field is not valid for endpoint devices.
15	Reject Snoop Transactions — RO. Hardwired to 0 since this field is not valid for endpoint devices.
14	Advanced Packet Switching — RO. Hardwired to 0 since this field is not valid for endpoint devices.
13:8	Reserved
7:0	Port Arbitration Capability — RO. Hardwired to 0 since this field is not valid for endpoint devices.

17.1.1.45 VCI_{CTL}—VCI Resource Control Register (Intel® High Definition Audio Controller—D27:F0)

Address Offset: 120h–123h Attribute: R/W, RO
 Default Value: 00000000h Size: 32 bits
 Function Level Reset: No

Bit	Description
31	VCI Enable — R/W. 0 = VCI is disabled 1 = VCI is enabled NOTE: This bit is not reset on D3 _{HOT} to D0 transition; however, it is reset by PLTRST#.
30:27	Reserved
26:24	VCI ID — R/W. This field assigns a VC ID to the VCI resource. This field is not used by the PCH hardware, but it is R/W to avoid confusing software.
23:20	Reserved
19:17	Port Arbitration Select — RO. Hardwired to 0 since this field is not valid for endpoint devices.
16	Load Port Arbitration Table — RO. Hardwired to 0 since this field is not valid for endpoint devices.
15:8	Reserved
7:0	TC/VCI Map — R/W, RO. This field indicates the TCs that are mapped to the VCI resource. Bit 0 is hardwired to 0 indicating that it cannot be mapped to VCI. Bits [7:1] are implemented as R/W bits. This field is not used by the PCH hardware, but it is R/W to avoid confusing software.



17.1.1.46 VCISTS—VCI Resource Status Register (Intel® High Definition Audio Controller—D27:F0)

Address Offset: 126h–127h Attribute: RO
 Default Value: 0000h Size: 16 bits

Bit	Description
15:2	Reserved
1	VCI Negotiation Pending — RO. Does not apply. Hardwired to 0.
0	Port Arbitration Table Status — RO. Hardwired to 0 since this field is not valid for endpoint devices.

17.1.1.47 RCCAP—Root Complex Link Declaration Enhanced Capability Header Register (Intel® High Definition Audio Controller—D27:F0)

Address Offset: 130h–133h Attribute: RO
 Default Value: 00010005h Size: 32 bits

Bit	Description
31:20	Next Capability Offset — RO. Hardwired to 0 indicating this is the last capability.
19:16	Capability Version — RO. Hardwired to 1h.
15:0	PCI Express* Extended Capability ID — RO. Hardwired to 0005h.

17.1.1.48 ESD—Element Self Description Register (Intel® High Definition Audio Controller—D27:F0)

Address Offset: 134h–137h Attribute: RO
 Default Value: 0F000100h Size: 32 bits

Bit	Description
31:24	Port Number — RO. Hardwired to 0Fh indicating that the Intel® High Definition Audio controller is assigned as Port #15d.
23:16	Component ID — RO. This field returns the value of the ESD.CID field of the chip configuration section. ESD.CID is programmed by BIOS.
15:8	Number of Link Entries — RO. The Intel® High Definition Audio only connects to one device, the PCH egress port. Therefore, this field reports a value of 1h.
7:4	Reserved
3:0	Element Type (ELTYP) — RO. The Intel® High Definition Audio controller is an integrated Root Complex Device. Therefore, the field reports a value of 0h.



17.1.1.49 L1DESC—Link 1 Description Register (Intel® High Definition Audio Controller—D27:F0)

Address Offset: 140h–143h Attribute: RO
Default Value: 00000001h Size: 32 bits

Bit	Description
31:24	Target Port Number — RO. The Intel® High Definition Audio controller targets the PCH's Port 0.
23:16	Target Component ID — RO. This field returns the value of the ESD.CID field of the chip configuration section. ESD.CID is programmed by BIOS.
15:2	Reserved
1	Link Type — RO. Hardwired to 0 indicating Type 0.
0	Link Valid — RO. Hardwired to 1.

17.1.1.50 L1ADDL—Link 1 Lower Address Register (Intel® High Definition Audio Controller—D27:F0)

Address Offset: 148h–14Bh Attribute: RO
Default Value: See Register Description Size: 32 bits

Bit	Description
31:14	Link 1 Lower Address — RO. Hardwired to match the RCBA register value in the PCI-LPC bridge (D31:F0:F0h).
13:0	Reserved

17.1.1.51 L1ADDU—Link 1 Upper Address Register (Intel® High Definition Audio Controller—D27:F0)

Address Offset: 14Ch–14Fh Attribute: RO
Default Value: 00000000h Size: 32 bits

Bit	Description
31:0	Link 1 Upper Address — RO. Hardwired to 00000000h.



17.1.2 Intel® High Definition Audio Memory Mapped Configuration Registers (Intel® High Definition Audio D27:F0)

The base memory location for these memory mapped configuration registers is specified in the HDBAR register (D27:F0:offset 10h and D27:F0:offset 14h). The individual registers are then accessible at HDBAR + Offset as indicated in Table 17-2.

These memory mapped registers must be accessed in byte, word, or DWord quantities.

Note: Address locations that are not shown should be treated as Reserved.

Table 17-2. Intel® High Definition Audio Memory Mapped Configuration Registers Address Map (Intel® High Definition Audio D27:F0) (Sheet 1 of 4)

HDBAR + Offset	Mnemonic	Register Name	Default	Attribute
00h-01h	GCAP	Global Capabilities	4401h	RO, R/WO
02h	VMIN	Minor Version	00h	RO
03h	VMAJ	Major Version	01h	RO
04h-05h	OUTPAY	Output Payload Capability	003Ch	RO
06h-07h	INPAY	Input Payload Capability	001Dh	RO
08h-0Bh	GCTL	Global Control	00000000h	R/W
0Ch-0Dh	WAKEEN	Wake Enable	0000h	R/W
0Eh-0Fh	STATESTS	State Change Status	0000h	R/WC
10h-11h	GSTS	Global Status	0000h	R/WC
18h-19h	OUTSTRMPAY	Output Stream Payload Capability	0030h	RO
1Ah-1Bh	INSTRMPAY	Input Stream Payload Capability	0018h	RO
1Ch-1Fh	—	Reserved	00000000h	RO
20h-23h	INTCTL	Interrupt Control	00000000h	R/W
24h-27h	INTSTS	Interrupt Status	00000000h	RO
30h-33h	WALCLK	Wall Clock Counter	00000000h	RO
38h-3Bh	SSYNC	Stream Synchronization	00000000h	R/W
40h-43h	CORBLCASE	CORB Lower Base Address	00000000h	R/W, RO
44h-47h	CORBUBASE	CORB Upper Base Address	00000000h	R/W
48h-49h	CORBWP	CORB Write Pointer	0000h	R/W
4Ah-4Bh	CORBRP	CORB Read Pointer	0000h	R/W, RO
4Ch	CORBCTL	CORB Control	00h	R/W
4Dh	CORBST	CORB Status	00h	R/WC
4Eh	CORBSIZE	CORB Size	42h	RO
50h-53h	RIRBLBASE	RIRB Lower Base Address	00000000h	R/W, RO
54h-57h	RIRBUBASE	RIRB Upper Base Address	00000000h	R/W
58h-59h	RIRBWP	RIRB Write Pointer	0000h	R/W, RO
5Ah-5Bh	RINTCNT	Response Interrupt Count	0000h	R/W
5Ch	RIRBCTL	RIRB Control	00h	R/W



Table 17-2. Intel® High Definition Audio Memory Mapped Configuration Registers Address Map (Intel® High Definition Audio D27:F0) (Sheet 2 of 4)

HDBAR + Offset	Mnemonic	Register Name	Default	Attribute
5Dh	RIRBSTS	RIRB Status	00h	R/WC
5Eh	RIRBSIZE	RIRB Size	42h	RO
60h-63h	IC	Immediate Command	00000000h	R/W
64h-67h	IR	Immediate Response	00000000h	RO
68h-69h	ICS	Immediate Command Status	0000h	R/W, R/WC
70h-73h	DPLBASE	DMA Position Lower Base Address	00000000h	R/W, RO
74h-77h	DPUBASE	DMA Position Upper Base Address	00000000h	R/W
80h-82h	ISD0CTL	Input Stream Descriptor Control	040000h	R/W, RO
83h	ISD0STS	ISD0 Status	00h	R/WC, RO
84h-87h	ISD0LPIB	ISD0 Link Position in Buffer	00000000h	RO
88h-8Bh	ISD0CBL	ISD0 Cyclic Buffer Length	00000000h	R/W
8Ch-8Dh	ISD0LVI	ISD0 Last Valid Index	0000h	R/W
8Eh-8F	ISD0FIFOW	ISD0 FIFO Watermark	0004h	R/W
90h-91h	ISD0FIFOS	ISD0 FIFO Size	0000h	R/W
92h-93h	ISD0FMT	ISD0 Format	0000h	R/W
98h-9Bh	ISD0BDPL	ISD0 Buffer Descriptor List Pointer – Lower Base Address	00000000h	R/W, RO
9Ch-9Fh	ISD0BDPU	ISD0 Buffer Description List Pointer – Upper Base Address	00000000h	R/W
A0h-A2h	ISD1CTL	Input Stream Descriptor 1 (ISD1) Control	040000h	R/W, RO
A3h	ISD1STS	ISD1 Status	00h	R/WC, RO
A4h-A7h	ISD1LPIB	ISD1 Link Position in Buffer	00000000h	RO
A8h-ABh	ISD1CBL	ISD1 Cyclic Buffer Length	00000000h	R/W
ACH-ADh	ISD1LVI	ISD1 Last Valid Index	0000h	R/W
Aeh-AFh	ISD1FIFOW	ISD1 FIFO Watermark	0004h	R/W
B0h-B1h	ISD1FIFOS	ISD1 FIFO Size	0000h	R/W
B2h-B3h	ISD1FMT	ISD1 Format	0000h	R/W
B8h-BBh	ISD1BDPL	ISD1 Buffer Descriptor List Pointer – Lower Base Address	00000000h	R/W, RO
BCh-BFh	ISD1BDPU	ISD1 Buffer Description List Pointer – Upper Base Address	00000000h	R/W
C0h-C2h	ISD2CTL	Input Stream Descriptor 2 (ISD2) Control	040000h	R/W, RO
C3h	ISD2STS	ISD2 Status	00h	R/WC, RO
C4h-C7h	ISD2LPIB	ISD2 Link Position in Buffer	00000000h	RO
C8h-CBh	ISD2CBL	ISD2 Cyclic Buffer Length	00000000h	R/W
CCh-CDh	ISD2LVI	ISD2 Last Valid Index	0000h	R/W



Table 17-2. Intel® High Definition Audio Memory Mapped Configuration Registers Address Map (Intel® High Definition Audio D27:F0) (Sheet 3 of 4)

HDBAR + Offset	Mnemonic	Register Name	Default	Attribute
CEh–CFh	ISD1FIFOW	ISD1 FIFO Watermark	0004h	R/W
D0h–D1h	ISD2FIFOS	ISD2 FIFO Size	0000h	R/W
D2h–D3h	ISD2FMT	ISD2 Format	0000h	R/W
D8h–DBh	ISD2BDPL	ISD2 Buffer Descriptor List Pointer – Lower Base Address	00000000h	R/W, RO
DCh–DFh	ISD2BDPU	ISD2 Buffer Description List Pointer – Upper Base Address	00000000h	R/W
E0h–E2h	ISD3CTL	Input Stream Descriptor 3 (ISD3) Control	040000h	R/W, RO
E3h	ISD3STS	ISD3 Status	00h	R/WC, RO
E4h–E7h	ISD3LPiB	ISD3 Link Position in Buffer	00000000h	RO
E8h–EBh	ISD3CBL	ISD3 Cyclic Buffer Length	00000000h	R/W
ECh–EDh	ISD3LVI	ISD3 Last Valid Index	0000h	R/W
EEh–EFh	ISD3FIFOW	ISD3 FIFO Watermark	0004h	R/W
F0h–F1h	ISD3FIFOS	ISD3 FIFO Size	0000h	R/W
F2h–F3h	ISD3FMT	ISD3 Format	0000h	R/W
F8h–FBh	ISD3BDPL	ISD3 Buffer Descriptor List Pointer – Lower Base Address	00000000h	R/W, RO
FCh–FFh	ISD3BDPU	ISD3 Buffer Description List Pointer – Upper Base Address	00000000h	R/W
100h–102h	OSD0CTL	Output Stream Descriptor 0 (OSD0) Control	040000h	R/W, RO
103h	OSD0STS	OSD0 Status	00h	R/WC, RO
104h–107h	OSD0LPiB	OSD0 Link Position in Buffer	00000000h	RO
108h–10Bh	OSD0CBL	OSD0 Cyclic Buffer Length	00000000h	R/W
10Ch–10Dh	OSD0LVI	OSD0 Last Valid Index	0000h	R/W
10Eh–10Fh	OSD0FIFOW	OSD0 FIFO Watermark	0004h	R/W
110h–111h	OSD0FIFOS	OSD0 FIFO Size	0000h	R/W
112–113h	OSD0FMT	OSD0 Format	0000h	R/W
118h–11Bh	OSD0BDPL	OSD0 Buffer Descriptor List Pointer – Lower Base Address	00000000h	R/W, RO
11Ch–11Fh	OSD0BDPU	OSD0 Buffer Description List Pointer – Upper Base Address	00000000h	R/W
120h–122h	OSD1CTL	Output Stream Descriptor 1 (OSD1) Control	040000h	R/W, RO
123h	OSD1STS	OSD1 Status	00h	R/WC, RO
124h–127h	OSD1LPiB	OSD1 Link Position in Buffer	00000000h	RO
128h–12Bh	OSD1CBL	OSD1 Cyclic Buffer Length	00000000h	R/W
12Ch–12Dh	OSD1LVI	OSD1 Last Valid Index	0000h	R/W



Table 17-2. Intel® High Definition Audio Memory Mapped Configuration Registers Address Map (Intel® High Definition Audio D27:F0) (Sheet 4 of 4)

HDBAR + Offset	Mnemonic	Register Name	Default	Attribute
12Eh-12Fh	OSD1FIFOW	OSD1 FIFO Watermark	0004h	R/W
130h-131h	OSD1FIFOS	OSD1 FIFO Size	0000h	R/W
132h-133h	OSD1FMT	OSD1 Format	0000h	R/W
138h-13Bh	OSD1BDPL	OSD1 Buffer Descriptor List Pointer – Lower Base Address	00000000h	R/W, RO
13Ch-13Fh	OSD1BDPU	OSD1 Buffer Description List Pointer – Upper Base Address	00000000h	R/W
140h-142h	OSD2CTL	Output Stream Descriptor 2 (OSD2) Control	040000h	R/W, RO
143h	OSD2STS	OSD2 Status	00h	R/WC, RO
144h-147h	OSD2LPB	OSD2 Link Position in Buffer	00000000h	RO
148h-14Bh	OSD2CBL	OSD2 Cyclic Buffer Length	00000000h	R/W
14Ch-14Dh	OSD2LVI	OSD2 Last Valid Index	0000h	R/W
14Eh-14Fh	OSD2FIFOW	OSD2 FIFO Watermark	0004h	R/W
150h-151h	OSD2FIFOS	OSD2 FIFO Size	0000h	R/W
152h-153h	OSD2FMT	OSD2 Format	0000h	R/W
158h-15Bh	OSD2BDPL	OSD2 Buffer Descriptor List Pointer – Lower Base Address	00000000h	R/W, RO
15Ch-15Fh	OSD2BDPU	OSD2 Buffer Description List Pointer – Upper Base Address	00000000h	R/W
160h-162h	OSD3CTL	Output Stream Descriptor 3 (OSD3) Control	040000h	R/W, RO
163h	OSD3STS	OSD3 Status	00h	R/WC, RO
164h-167h	OSD3LPB	OSD3 Link Position in Buffer	00000000h	RO
168h-16Bh	OSD3CBL	OSD3 Cyclic Buffer Length	00000000h	R/W
16Ch-16Dh	OSD3LVI	OSD3 Last Valid Index	0000h	R/W
16Eh-16Fh	OSD3FIFOW	OSD3 FIFO Watermark	0004h	R/W
170h-171h	OSD3FIFOS	OSD3 FIFO Size	0000h	R/W
172h-173h	OSD3FMT	OSD3 Format	0000h	R/W
178h-17Bh	OSD3BDPL	OSD3 Buffer Descriptor List Pointer – Lower Base Address	00000000h	R/W, RO
17Ch-17Fh	OSD3BDPU	OSD3 Buffer Description List Pointer – Upper Base Address	00000000h	R/W



17.1.2.1 GCAP—Global Capabilities Register (Intel® High Definition Audio Controller—D27:F0)

Memory Address: HDBAR + 00h Attribute: RO, R/WO
Default Value: 4401h Size: 16 bits

Bit	Description
15:12	Number of Output Stream Supported — R/WO. 0100b indicates that the PCH's Intel® High Definition Audio controller supports 4 output streams.
11:8	Number of Input Stream Supported — R/WO. 0100b indicates that the PCH's Intel® High Definition Audio controller supports 4 input streams.
7:3	Number of Bidirectional Stream Supported — RO. Hardwired to 0 indicating that the PCH's Intel® High Definition Audio controller supports 0 bidirectional stream.
2:1	Number of Serial Data Out Signals — RO. Hardwired to 0 indicating that the PCH's Intel® High Definition Audio controller supports 1 serial data output signal.
0	64-bit Address Supported — R/WO. 1b indicates that the PCH's Intel® High Definition Audio controller supports 64-bit addressing for BDL addresses, data buffer addressees, and command buffer addresses.

17.1.2.2 VMIN—Minor Version Register (Intel® High Definition Audio Controller—D27:F0)

Memory Address: HDBAR + 02h Attribute: RO
Default Value: 00h Size: 8 bits

Bit	Description
7:0	Minor Version — RO. Hardwired to 0 indicating that the PCH supports minor revision number 00h of the Intel® High Definition Audio specification.

17.1.2.3 VMAJ—Major Version Register (Intel® High Definition Audio Controller—D27:F0)

Memory Address: HDBAR + 03h Attribute: RO
Default Value: 01h Size: 8 bits

Bit	Description
7:0	Major Version — RO. Hardwired to 01h indicating that the PCH supports major revision number 1 of the Intel® High Definition Audio specification.

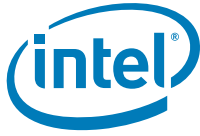

17.1.2.4 **OUTPUTPAY—Output Payload Capability Register (Intel® High Definition Audio Controller—D27:F0)**

Memory Address:HDBAR + 04h Attribute: RO
Default Value: 003Ch Size: 16 bits

Bit	Description
15:7	Reserved
6:0	Output Payload Capability — RO. Hardwired to 3Ch indicating 60 word payload. This field indicates the total output payload available on the link. This does not include bandwidth used for command and control. This measurement is in 16-bit word quantities per 48 MHz frame. The default link clock of 24.000 MHz (the data is double pumped) provides 1000 bits per frame, or 62.5 words in total. 40 bits are used for command and control, leaving 60 words available for data payload. 00h = 0 word 01h = 1 word payload. FFh = 256 word payload.

17.1.2.5 **INPAY—Input Payload Capability Register (Intel® High Definition Audio Controller—D27:F0)**

Memory Address:HDBAR + 06h Attribute: RO
Default Value: 001Dh Size: 16 bits

Bit	Description
15:7	Reserved
6:0	Input Payload Capability — RO. Hardwired to 1Dh indicating 29 word payload. This field indicates the total output payload available on the link. This does not include bandwidth used for response. This measurement is in 16-bit word quantities per 48 MHz frame. The default link clock of 24.000 MHz provides 500 bits per frame, or 31.25 words in total. 36 bits are used for response, leaving 29 words available for data payload. 00h = 0 word 01h = 1 word payload. FFh = 256 word payload.



17.1.2.6 GCTL—Global Control Register (Intel® High Definition Audio Controller—D27:F0)

Memory Address: HDBAR + 08h
 Default Value: 00000000h

Attribute: R/W
 Size: 32 bits

Bit De	scription
31:9	Reserved
8	<p>Accept Unsolicited Response Enable — R/W.</p> <p>0 = Unsolicited responses from the codecs are not accepted. 1 = Unsolicited response from the codecs are accepted by the controller and placed into the Response Input Ring Buffer.</p>
7:2	Reserved
1	<p>Flush Control — R/W. Writing a 1 to this bit initiates a flush. When the flush completion is received by the controller, hardware sets the Flush Status bit and clears this Flush Control bit. Before a flush cycle is initiated, the DMA Position Buffer must be programmed with a valid memory address by software, but the DMA Position Buffer bit 0 needs not be set to enable the position reporting mechanism. Also, all streams must be stopped (the associated RUN bit must be 0). When the flush is initiated, the controller will flush the pipelines to memory to ensure that the hardware is ready to transition to a D3 state. Setting this bit is not a critical step in the power state transition if the content of the FIFOs is not critical.</p>
0	<p>Controller Reset # — R/W.</p> <p>0 = Writing a 0 causes the Intel® High Definition Audio controller to be reset. All state machines, FIFOs, and non-resume well memory mapped configuration registers (not PCI configuration registers) in the controller will be reset. The Intel® High Definition Audio link RESET# signal will be asserted, and all other link signals will be driven to their default values. After the hardware has completed sequencing into the reset state, it will report a 0 in this bit. Software must read a 0 from this bit to verify the controller is in reset.</p> <p>1 = Writing a 1 causes the controller to exit its reset state and deassert the Intel® High Definition Audio link RESET# signal. Software is responsible for setting/clearing this bit such that the minimum Intel® High Definition Audio link RESET# signal assertion pulse width specification is met. When the controller hardware is ready to begin operation, it will report a 1 in this bit. Software must read a 1 from this bit before accessing any controller registers. This bit defaults to a 0 after Hardware reset, therefore, software needs to write a 1 to this bit to begin operation.</p> <p>NOTES:</p> <ol style="list-style-type: none"> 1. The CORB/RIRB RUN bits and all stream RUN bits must be verified cleared to 0 before writing a 0 to this bit in order to assure a clean re-start. 2. When setting or clearing this bit, software must ensure that minimum link timing requirements (minimum RESET# assertion time, etc.) are met. 3. When this bit is 0 indicating that the controller is in reset, writes to all Intel High Definition Audio memory mapped registers are ignored as if the device is not present. The only exception is this register itself. The Global Control register is write-able as a DWord, Word, or Byte even when CRST# (this bit) is 0 if the byte enable for the byte containing the CRST# bit (Byte Enable 0) is active. If Byte Enable 0 is not active, writes to the Global Control register will be ignored when CRST# is 0. When CRST# is 0, reads to Intel High Definition Audio memory mapped registers will return their default value except for registers that are not reset with PLTRST# or on a D3_{HOT} to D0 transition.



17.1.2.7 WAKEEN—Wake Enable Register (Intel® High Definition Audio Controller—D27:F0)

Memory Address: HDBAR + 0Ch Attribute: R/W
Default Value: 0000h Size: 16 bits
Function Level Reset: No

Bit	Description
15:4	Reserved
3:0	<p>SDIN Wake Enable Flags — R/W. These bits control which SDI signal(s) may generate a wake event. A 1b in the bit mask indicates that the associated SDIN signal is enabled to generate a wake.</p> <p>Bit 0 is used for SDI[0] Bit 1 is used for SDI[1] Bit 2 is used for SDI[2] Bit 3 is used for SDI[3]</p> <p>NOTE: These bits are in the resume well and only cleared on a power on reset. Software must not make assumptions about the reset state of these bits and must set them appropriately.</p>

17.1.2.8 STATESTS—State Change Status Register (Intel® High Definition Audio Controller—D27:F0)

Memory Address: HDBAR + 0Eh Attribute: R/WC
Default Value: 0000h Size: 16 bits
Function Level Reset: No

Bit	Description
15:4	Reserved
3:0	<p>SDIN State Change Status Flags — R/WC. Flag bits that indicate which SDI signal(s) received a state change event. The bits are cleared by writing 1s to them.</p> <p>Bit 0 = SDI[0] Bit 1 = SDI[1] Bit 2 = SDI[2] Bit 3 = SDI[3]</p> <p>These bits are in the resume well and only cleared on a power on reset. Software must not make assumptions about the reset state of these bits and must set them appropriately.</p>



17.1.2.9 GSTS—Global Status Register (Intel® High Definition Audio Controller—D27:F0)

Memory Address:HDBAR + 10h Attribute: R/WC
 Default Value: 0000h Size: 16 bits

Bit	Description
15:2	Reserved
1	Flush Status — R/WC. This bit is set to 1 by hardware to indicate that the flush cycle initiated when the Flush Control bit (HDBAR + 08h, bit 1) was set has completed. Software must write a 1 to clear this bit before the next time the Flush Control bit is set to clear the bit.
0	Reserved

17.1.2.10 OUTSTRMPAY—Output Stream Payload Capability (Intel® High Definition Audio Controller—D27:F0)

Memory Address:HDBAR + 18h Attribute: RO
 Default Value: 0030h Size: 16 bits

Bit	Description
15:8	Reserved
7:0	Output Stream Payload Capability (OUTSTRMPAY) — RO: Indicates maximum number of words per frame for any single output stream. This measurement is in 16 bit word quantities per 48 kHz frame. 48 Words (96B) is the maximum supported, therefore a value of 30h is reported in this register. Software must ensure that a format which would cause more words per frame than indicated is not programmed into the Output Stream Descriptor register. 00h = 0 words 01h = 1 word payload ... FFh = 255h word payload

17.1.2.11 INSTRMPAY—Input Stream Payload Capability (Intel® High Definition Audio Controller—D27:F0)

Memory Address:HDBAR + 1Ah Attribute: RO
 Default Value: 0018h Size: 16 bits

Bit	Description
15:8	Reserved
7:0	Input Stream Payload Capability (INSTRMPAY) — RO. Indicates maximum number of words per frame for any single input stream. This measurement is in 16 bit word quantities per 48 kHz frame. 24 Words (48B) is the maximum supported, therefore a value of 18h is reported in this register. Software must ensure that a format which would cause more words per frame than indicated is not programmed into the Input Stream Descriptor register. 00h = 0 words 01h = 1 word payload ... FFh = 255h word payload



17.1.2.12 INTCTL—Interrupt Control Register (Intel® High Definition Audio Controller—D27:F0)

Memory Address: HDBAR + 20h
 Default Value: 00000000h

Attribute: R/W
 Size: 32 bits

Bit	Description
31	<p>Global Interrupt Enable (GIE) — R/W. Global bit to enable device interrupt generation.</p> <p>1 = When set to 1, the Intel High Definition Audio function is enabled to generate an interrupt. This control is in addition to any bits in the bus specific address space, such as the Interrupt Enable bit in the PCI configuration space.</p> <p>NOTE: This bit is not affected by the D3_{HOT} to D0 transition.</p>
30	<p>Controller Interrupt Enable (CIE) — R/W. Enables the general interrupt for controller functions.</p> <p>1 = When set to 1, the controller generates an interrupt when the corresponding status bit gets set due to a Response Interrupt, a Response Buffer Overrun, and State Change events.</p> <p>NOTE: This bit is not affected by the D3_{HOT} to D0 transition.</p>
29:8	Reserved
7:0	<p>Stream Interrupt Enable (SIE) — R/W. When set to 1, the individual streams are enabled to generate an interrupt when the corresponding status bits get set.</p> <p>A stream interrupt will be caused as a result of a buffer with IOC = 1 in the BDL entry being completed, or as a result of a FIFO error (underrun or overrun) occurring. Control over the generation of each of these sources is in the associated Stream Descriptor.</p> <p>The streams are numbered and the SIE bits assigned sequentially, based on their order in the register set.</p> <ul style="list-style-type: none"> Bit 0 = input stream 1 Bit 1 = input stream 2 Bit 2 = input stream 3 Bit 3 = input stream 4 Bit 4 = output stream 1 Bit 5 = output stream 2 Bit 6 = output stream 3 Bit 7 = output stream 4



17.1.2.13 INTSTS—Interrupt Status Register (Intel® High Definition Audio Controller—D27:F0)

Memory Address: HDBAR + 24h
Default Value: 00000000h

Attribute: RO
Size: 32 bits

Bit	Description
31	<p>Global Interrupt Status (GIS) — RO. This bit is an OR of all the interrupt status bits in this register.</p> <p>NOTE: This bit is not affected by the D_{3HOT} to D₀ transition.</p>
30	<p>Controller Interrupt Status (CIS) — RO. Status of general controller interrupt. 1 = Interrupt condition occurred due to a Response Interrupt, a Response Buffer Overrun Interrupt, or a SDIN State Change event. The exact cause can be determined by interrogating other registers. This bit is an OR of all of the stated interrupt status bits for this register.</p> <p>NOTES:</p> <ol style="list-style-type: none"> This bit is set regardless of the state of the corresponding interrupt enable bit, but a hardware interrupt will not be generated unless the corresponding enable bit is set. This bit is not affected by the D_{3HOT} to D₀ transition.
29:8	Reserved
7:0	<p>Stream Interrupt Status (SIS) — RO.</p> <p>1 = Interrupt condition occurred on the corresponding stream. This bit is an OR of all of the stream's interrupt status bits.</p> <p>NOTE: These bits are set regardless of the state of the corresponding interrupt enable bits.</p> <p>The streams are numbered and the SIE bits assigned sequentially, based on their order in the register set.</p> <p>Bit 0 = input stream 1 Bit 1 = input stream 2 Bit 2 = input stream 3 Bit 3 = input stream 4 Bit 4 = output stream 1 Bit 5 = output stream 2 Bit 6 = output stream 3 Bit 7 = output stream 4</p>

17.1.2.14 WALCLK—Wall Clock Counter Register (Intel® High Definition Audio Controller—D27:F0)

Memory Address: HDBAR + 30h
Default Value: 00000000h

Attribute: RO
Size: 32 bits

Bit	Description
31:0	<p>Wall Clock Counter — RO. A 32-bit counter that is incremented on each link Bit Clock period and rolls over from FFFF FFFFh to 0000 0000h. This counter will roll over to 0 with a period of approximately 179 seconds.</p> <p>This counter is enabled while the Bit Clock bit is set to 1. Software uses this counter to synchronize between multiple controllers. Will be reset on controller reset.</p>



17.1.2.15 SSYNC—Stream Synchronization Register (Intel® High Definition Audio Controller—D27:F0)

Memory Address: HDBAR + 38h Attribute: R/W
 Default Value: 00000000h Size: 32 bits

Bit	Description
31:8	Reserved
7:0	<p>Stream Synchronization (SSYNC) — R/W. When set to 1, these bits block data from being sent on or received from the link. Each bit controls the associated stream descriptor (that is, bit 0 corresponds to the first stream descriptor, etc.)</p> <p>To synchronously start a set of DMA engines, these bits are first set to 1. The RUN bits for the associated stream descriptors are then set to 1 to start the DMA engines. When all streams are ready (FIFORDY = 1), the associated SSYNC bits can all be set to 0 at the same time, and transmission or reception of bits to or from the link will begin together at the start of the next full link frame.</p> <p>To synchronously stop the streams, first these bits are set, and then the individual RUN bits in the stream descriptor are cleared by software.</p> <p>If synchronization is not desired, these bits may be left as 0, and the stream will simply begin running normally when the stream’s RUN bit is set.</p> <p>The streams are numbered and the SIE bits assigned sequentially, based on their order in the register set.</p> <p>Bit 0 = input stream 1 Bit 1 = input stream 2 Bit 2 = input stream 3 Bit 3 = input stream 4 Bit 4 = output stream 1 Bit 5 = output stream 2 Bit 6 = output stream 3 Bit 7 = output stream 4</p>

17.1.2.16 CORBLBASE—CORB Lower Base Address Register (Intel® High Definition Audio Controller—D27:F0)

Memory Address: HDBAR + 40h Attribute: R/W, RO
 Default Value: 00000000h Size: 32 bits

Bit	Description
31:7	<p>CORB Lower Base Address — R/W. Lower address of the Command Output Ring Buffer, allowing the CORB base address to be assigned on any 128-B boundary. This register field must not be written when the DMA engine is running or the DMA transfer may be corrupted.</p>
6:0	<p>CORB Lower Base Unimplemented Bits — RO. Hardwired to 0. This required the CORB to be allocated with 128B granularity to allow for cache line fetch optimizations.</p>

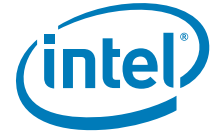

17.1.2.17 CORBUBASE—CORB Upper Base Address Register (Intel® High Definition Audio Controller—D27:F0)

Memory Address: HDBAR + 44h Attribute: R/W
 Default Value: 00000000h Size: 32 bits

Bit	Description
31:0	CORB Upper Base Address — R/W. Upper 32 bits of the address of the Command Output Ring buffer. This register field must not be written when the DMA engine is running or the DMA transfer may be corrupted.

17.1.2.18 CORBWP—CORB Write Pointer Register (Intel® High Definition Audio Controller—D27:F0)

Memory Address: HDBAR + 48h Attribute: R/W
 Default Value: 0000h Size: 16 bits

Bit	Description
15:8	Reserved
7:0	CORB Write Pointer — R/W. Software writes the last valid CORB entry offset into this field in DWord granularity. The DMA engine fetches commands from the CORB until the Read pointer matches the Write pointer. Supports 256 CORB entries (256x4B = 1KB). This register field may be written when the DMA engine is running.

17.1.2.19 CORBRP—CORB Read Pointer Register (Intel® High Definition Audio Controller—D27:F0)

Memory Address: HDBAR + 4Ah Attribute: R/W, RO
 Default Value: 0000h Size: 16 bits

Bit	Description
15	CORB Read Pointer Reset — R/W. Software writes a 1 to this bit to reset the CORB Read Pointer to 0 and clear any residual prefetched commands in the CORB hardware buffer within the Intel High Definition Audio controller. The hardware will physically update this bit to 1 when the CORB Pointer reset is complete. Software must read a 1 to verify that the reset completed correctly. Software must clear this bit back to 0 and read back the 0 to verify that the clear completed correctly. The CORB DMA engine must be stopped prior to resetting the Read Pointer or else DMA transfer may be corrupted.
14:8	Reserved
7:0	CORB Read Pointer (CORBRP) — RO. Software reads this field to determine how many commands it can write to the CORB without over-running. The value read indicates the CORB Read Pointer offset in DWord granularity. The offset entry read from this field has been successfully fetched by the DMA controller and may be over-written by software. Supports 256 CORB entries (256 x 4B=1KB). This field may be read while the DMA engine is running.

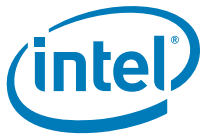

17.1.2.20 CORBCTL—CORB Control Register (Intel® High Definition Audio Controller—D27:F0)

Memory Address:HDBAR + 4Ch Attribute: R/W
 Default Value: 00h Size: 8 bits

Bit	Description
7:2	Reserved
1	Enable CORB DMA Engine — R/W. 0 = DMA stop 1 = DMA run After software writes a 0 to this bit, the hardware may not stop immediately. The hardware will physically update the bit to 0 when the DMA engine is truly stopped. Software must read a 0 from this bit to verify that the DMA engine is truly stopped.
0	CORB Memory Error Interrupt Enable — R/W. If this bit is set, the controller will generate an interrupt if the CMEI status bit (HDBAR + 4Dh: bit 0) is set.

17.1.2.21 CORBST—CORB Status Register (Intel® High Definition Audio Controller—D27:F0)

Memory Address:HDBAR + 4Dh Attribute: R/WC
 Default Value: 00h Size: 8 bits

Bit	Description
7:1	Reserved
0	CORB Memory Error Indication (CMEI) — R/WC. 1 = Controller detected an error in the path way between the controller and memory. This may be an ECC bit error or any other type of detectable data error which renders the command data fetched invalid. Software can clear this bit by writing a 1 to it. However, this type of error leaves the audio subsystem in an un-viable state and typically requires a controller reset by writing a 0 to the Controller Reset # bit (HDBAR + 08h: bit 0).

17.1.2.22 CORBSIZE—CORB Size Register (Intel® High Definition Audio Controller—D27:F0)

Memory Address:HDBAR + 4Eh Attribute: RO
 Default Value: 42h Size: 8 bits

Bit	Description
7:4	CORB Size Capability — RO. Hardwired to 0100b indicating that the PCH only supports a CORB size of 256 CORB entries (1024B)
3:2	Reserved
1:0	CORB Size — RO. Hardwired to 10b which sets the CORB size to 256 entries (1024B)



17.1.2.23 RIRBLBASE—RIRB Lower Base Address Register (Intel® High Definition Audio Controller—D27:F0)

Memory Address: HDBAR + 50h Attribute: R/W, RO
Default Value: 00000000h Size: 32 bits

Bit	Description
31:7	RIRB Lower Base Address — R/W. Lower address of the Response Input Ring Buffer, allowing the RIRB base address to be assigned on any 128-B boundary. This register field must not be written when the DMA engine is running or the DMA transfer may be corrupted.
6:0	RIRB Lower Base Unimplemented Bits — RO. Hardwired to 0. This required the RIRB to be allocated with 128-B granularity to allow for cache line fetch optimizations.

17.1.2.24 RIRBUBASE—RIRB Upper Base Address Register (Intel® High Definition Audio Controller—D27:F0)

Memory Address: HDBAR + 54h Attribute: R/W
Default Value: 00000000h Size: 32 bits

Bit	Description
31:0	RIRB Upper Base Address — R/W. Upper 32 bits of the address of the Response Input Ring Buffer. This register field must not be written when the DMA engine is running or the DMA transfer may be corrupted.

17.1.2.25 RIRBWP—RIRB Write Pointer Register (Intel® High Definition Audio Controller—D27:F0)

Memory Address: HDBAR + 58h Attribute: R/W, RO
Default Value: 0000h Size: 16 bits

Bit	Description
15	RIRB Write Pointer Reset — R/W. Software writes a 1 to this bit to reset the RIRB Write Pointer to 0. The RIRB DMA engine must be stopped prior to resetting the Write Pointer or else DMA transfer may be corrupted. This bit is always read as 0.
14:8	Reserved
7:0	RIRB Write Pointer (RIRBWP) — RO. Indicates the last valid RIRB entry written by the DMA controller. Software reads this field to determine how many responses it can read from the RIRB. The value read indicates the RIRB Write Pointer offset in 2 DWord RIRB entry units (since each RIRB entry is 2 DWords long). Supports up to 256 RIRB entries (256 x 8 B = 2 KB). This register field may be written when the DMA engine is running.



17.1.2.26 RINTCNT—Response Interrupt Count Register (Intel® High Definition Audio Controller—D27:F0)

Memory Address:HDBAR + 5Ah Attribute: R/W
 Default Value: 0000h Size: 16 bits

Bit	Description
15:8	Reserved
7:0	<p>N Response Interrupt Count — R/W. 0000 0001b = 1 response sent to RIRB 1111 1111b = 255 responses sent to RIRB 0000 0000b = 256 responses sent to RIRB</p> <p>The DMA engine should be stopped when changing this field or else an interrupt may be lost.</p> <p>Note that each response occupies 2 DWords in the RIRB. This is compared to the total number of responses that have been returned, as opposed to the number of frames in which there were responses. If more than one codecs responds in one frame, then the count is increased by the number of responses received in the frame.</p>

17.1.2.27 RIRBCTL—RIRB Control Register (Intel® High Definition Audio Controller—D27:F0)

Memory Address:HDBAR + 5Ch Attribute: R/W
 Default Value: 00h Size: 8 bits

Bit	Description
7:3	Reserved
2	<p>Response Overrun Interrupt Control — R/W. If this bit is set, the hardware will generate an interrupt when the Response Overrun Interrupt Status bit (HDBAR + 5Dh: bit 2) is set.</p>
1	<p>Enable RIRB DMA Engine — R/W. 0 = DMA stop 1 = DMA run</p> <p>After software writes a 0 to this bit, the hardware may not stop immediately. The hardware will physically update the bit to 0 when the DMA engine is truly stopped. Software must read a 0 from this bit to verify that the DMA engine is truly stopped.</p>
0	<p>Response Interrupt Control — R/W. 0 = Disable Interrupt 1 = Generate an interrupt after N number of responses are sent to the RIRB buffer OR when an empty Response slot is encountered on all SDI[x] inputs (whichever occurs first). The N counter is reset when the interrupt is generated.</p>

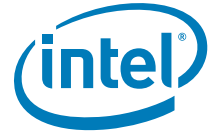

17.1.2.28 RIRBSTS—RIRB Status Register (Intel® High Definition Audio Controller—D27:F0)

Memory Address: HDBAR + 5Dh Attribute: R/WC
 Default Value: 00h Size: 8 bits

Bit	Description
7:3	Reserved
2	<p>Response Overrun Interrupt Status — R/WC. 1 = Software sets this bit to 1 when the RIRB DMA engine is not able to write the incoming responses to memory before additional incoming responses overrun the internal FIFO. When the overrun occurs, the hardware will drop the responses which overrun the buffer. An interrupt may be generated if the Response Overrun Interrupt Control bit is set. Note that this status bit is set even if an interrupt is not enabled for this event. Software clears this bit by writing a 1 to it.</p>
1	Reserved
0	<p>Response Interrupt — R/WC. 1 = Hardware sets this bit to 1 when an interrupt has been generated after N number of Responses are sent to the RIRB buffer OR when an empty Response slot is encountered on all SDI[x] inputs (whichever occurs first). Note that this status bit is set even if an interrupt is not enabled for this event. Software clears this bit by writing a 1 to it.</p>

17.1.2.29 RIRBSIZE—RIRB Size Register (Intel® High Definition Audio Controller—D27:F0)

Memory Address: HDBAR + 5Eh Attribute: RO
 Default Value: 42h Size: 8 bits

Bit	Description
7:4	RIRB Size Capability — RO. Hardwired to 0100b indicating that the PCH only supports a RIRB size of 256 RIRB entries (2048B).
3:2	Reserved
1:0	RIRB Size — RO. Hardwired to 10b which sets the CORB size to 256 entries (2048B).

17.1.2.30 IC—Immediate Command Register (Intel® High Definition Audio Controller—D27:F0)

Memory Address: HDBAR + 60h Attribute: R/W
 Default Value: 00000000h Size: 32 bits

Bit	Description
31:0	Immediate Command Write — R/W. The command to be sent to the codec using the Immediate Command mechanism is written to this register. The command stored in this register is sent out over the link during the next available frame after a 1 is written to the ICB bit (HDBAR + 68h: bit 0).



17.1.2.31 IR—Immediate Response Register (Intel® High Definition Audio Controller—D27:F0)

Memory Address:HDBAR + 64h
Default Value: 00000000h

Attribute: RO
Size: 32 bits

Bit	Description
31:0	Immediate Response Read (IRR) — RO. This register contains the response received from a codec resulting from a command sent using the Immediate Command mechanism. If multiple codecs responded in the same time, there is no assurance as to which response will be latched. Therefore, broadcast-type commands must not be issued using the Immediate Command mechanism.

17.1.2.32 ICS—Immediate Command Status Register (Intel® High Definition Audio Controller—D27:F0)

Memory Address:HDBAR + 68h
Default Value: 0000h

Attribute: R/W, R/WC
Size: 16 bits

Bit	Description
15:2	Reserved
1	Immediate Result Valid (IRV) — R/WC. 1 = Set to 1 by hardware when a new response is latched into the Immediate Response register (HDBAR + 64). This is a status flag indicating that software may read the response from the Immediate Response register. Software must clear this bit by writing a 1 to it before issuing a new command so that the software may determine when a new response has arrived.
0	Immediate Command Busy (ICB) — R/W. When this bit is read as 0, it indicates that a new command may be issued using the Immediate Command mechanism. When this bit transitions from a 0 to a 1 (using software writing a 1), the controller issues the command currently stored in the Immediate Command register to the codec over the link. When the corresponding response is latched into the Immediate Response register, the controller hardware sets the IRV flag and clears the ICB bit back to 0. Software may write this bit to a 0 if the bit fails to return to 0 after a reasonable time out period. NOTE: An Immediate Command must not be issued while the CORB/RIRB mechanism is operating, otherwise the responses conflict. This must be enforced by software.

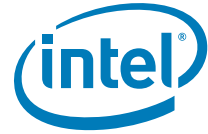

17.1.2.33 DPLBASE—DMA Position Lower Base Address Register (Intel® High Definition Audio Controller—D27:F0)

Memory Address: HDBAR + 70h Attribute: R/W, RO
 Default Value: 00000000h Size: 32 bits

Bit	Description
31:7	DMA Position Lower Base Address — R/W. Lower 32 bits of the DMA Position Buffer Base Address. This register field must not be written when any DMA engine is running or the DMA transfer may be corrupted. This same address is used by the Flush Control and must be programmed with a valid value before the Flush Control bit (HDBAR+08h:bit 1) is set.
6:1	DMA Position Lower Base Unimplemented bits — RO. Hardwired to 0 to force the 128-byte buffer alignment for cache line write optimizations.
0	DMA Position Buffer Enable — R/W. 1 = Controller will write the DMA positions of each of the DMA engines to the buffer in the main memory periodically (typically once per frame). Software can use this value to know what data in memory is valid data.

17.1.2.34 DPUBASE—DMA Position Upper Base Address Register (Intel® High Definition Audio Controller—D27:F0)

Memory Address: HDBAR + 74h Attribute: R/W
 Default Value: 00000000h Size: 32 bits

Bit	Description
31:0	DMA Position Upper Base Address — R/W. Upper 32 bits of the DMA Position Buffer Base Address. This register field must not be written when any DMA engine is running or the DMA transfer may be corrupted.



17.1.2.35 SDCTL—Stream Descriptor Control Register (Intel® High Definition Audio Controller—D27:F0)

Memory Address: Input Stream[0]: HDBAR + 80h Attribute: R/W, RO
 Input Stream[1]: HDBAR + A0h
 Input Stream[2]: HDBAR + C0h
 Input Stream[3]: HDBAR + E0h
 Output Stream[0]: HDBAR + 100h
 Output Stream[1]: HDBAR + 120h
 Output Stream[2]: HDBAR + 140h
 Output Stream[3]: HDBAR + 160h
 Default Value: 040000h Size: 24 bits

Bit	Description
23:20	<p>Stream Number — R/W. This value reflect the Tag associated with the data being transferred on the link.</p> <p>When data controlled by this descriptor is sent out over the link, it will have its stream number encoded on the SYNC signal.</p> <p>When an input stream is detected on any of the SDI signals that match this value, the data samples are loaded into FIFO associated with this descriptor.</p> <p>Note that while a single SDI input may contain data from more than one stream number, two different SDI inputs may not be configured with the same stream number.</p> <p>0000 = Reserved 0001 = Stream 1 1110 = Stream 14 1111 = Stream 15</p>
19	<p>Bidirectional Direction Control — RO. This bit is only meaningful for bidirectional streams; therefore, this bit is hardwired to 0.</p>
18	<p>Traffic Priority — RO. Hardwired to 1 indicating that all streams will use VC1 if it is enabled through the PCI Express* registers.</p>
17:16	<p>Stripe Control — RO. This bit is only meaningful for input streams; therefore, this bit is hardwired to 0.</p>
15:5	Reserved
4	<p>Descriptor Error Interrupt Enable — R/W. 0 = Disable 1 = An interrupt is generated when the Descriptor Error Status bit is set.</p>
3	<p>FIFO Error Interrupt Enable — R/W. This bit controls whether the occurrence of a FIFO error (overflow for input or underflow for output) will cause an interrupt or not. If this bit is not set, bit 3 in the Status register will be set, but the interrupt will not occur. Either way, the samples will be dropped.</p>
2	<p>Interrupt on Completion Enable — R/W. This bit controls whether or not an interrupt occurs when a buffer completes with the IOC bit set in its descriptor. If this bit is not set, bit 2 in the Status register will be set, but the interrupt will not occur.</p>
1	<p>Stream Run (RUN) — R/W. 0 = DMA engine associated with this input stream will be disabled. The hardware will report a 0 in this bit when the DMA engine is actually stopped. Software must read a 0 from this bit before modifying related control registers or restarting the DMA engine. 1 = DMA engine associated with this input stream will be enabled to transfer data from the FIFO to the main memory. The SSYNC bit must also be cleared in order for the DMA engine to run. For output streams, the cadence generator is reset whenever the RUN bit is set.</p>



Bit	Description
0	<p>Stream Reset (SRST) — R/W.</p> <p>0 = Writing a 0 causes the corresponding stream to exit reset. When the stream hardware is ready to begin operation, it will report a 0 in this bit. Software must read a 0 from this bit before accessing any of the stream registers.</p> <p>1 = Writing a 1 causes the corresponding stream to be reset. The Stream Descriptor registers (except the SRST bit itself) and FIFOs for the corresponding stream are reset. After the stream hardware has completed sequencing into the reset state, it will report a 1 in this bit. Software must read a 1 from this bit to verify that the stream is in reset. The RUN bit must be cleared before SRST is asserted.</p>

17.1.2.36 SDSTS—Stream Descriptor Status Register (Intel® High Definition Audio Controller—D27:F0)

Memory Address:	Input Stream[0]: HDBAR + 83h Input Stream[1]: HDBAR + A3h Input Stream[2]: HDBAR + C3h Input Stream[3]: HDBAR + E3h Output Stream[0]: HDBAR + 103h Output Stream[1]: HDBAR + 123h Output Stream[2]: HDBAR + 143h Output Stream[3]: HDBAR + 163h	Attribute:	R/WC, RO
Default Value:	00h	Size:	8 bits

Bit	Description
7:6	Reserved
5	<p>FIFO Ready (FIFORDY) — RO. For output streams, the controller hardware will set this bit to 1 while the output DMA FIFO contains enough data to maintain the stream on the link. This bit defaults to 0 on reset because the FIFO is cleared on a reset.</p> <p>For input streams, the controller hardware will set this bit to 1 when a valid descriptor is loaded and the engine is ready for the RUN bit to be set.</p>
4	<p>Descriptor Error — R/WC.</p> <p>1 = A serious error occurred during the fetch of a descriptor. This could be a result of a Master Abort, a parity or ECC error on the bus, or any other error which renders the current Buffer Descriptor or Buffer Descriptor list useless. This error is treated as a fatal stream error, as the stream cannot continue running. The RUN bit will be cleared and the stream will stopped.</p> <p>Software may attempt to restart the stream engine after addressing the cause of the error and writing a 1 to this bit to clear it.</p>
3	<p>FIFO Error — R/WC.</p> <p>1 = FIFO error occurred. This bit is set even if an interrupt is not enabled. The bit is cleared by writing a 1 to it.</p> <p>For an input stream, this indicates a FIFO overrun occurring while the RUN bit is set. When this happens, the FIFO pointers do not increment and the incoming data is not written into the FIFO, thereby being lost.</p> <p>For an output stream, this indicates a FIFO underrun when there are still buffers to send. The hardware should not transmit anything on the link for the associated stream if there is not valid data to send.</p>
2	<p>Buffer Completion Interrupt Status — R/WC.</p> <p>This bit is set to 1 by the hardware after the last sample of a buffer has been processed, AND if the Interrupt on Completion bit is set in the command byte of the buffer descriptor. It remains active until software clears it by writing a 1 to it.</p>
1:0	Reserved



17.1.2.37 SDLPB—Stream Descriptor Link Position in Buffer Register (Intel® High Definition Audio Controller—D27:F0)

Memory Address: Input Stream[0]: HDBAR + 84h Attribute: RO
 Input Stream[1]: HDBAR + A4h
 Input Stream[2]: HDBAR + C4h
 Input Stream[3]: HDBAR + E4h
 Output Stream[0]: HDBAR + 104h
 Output Stream[1]: HDBAR + 124h
 Output Stream[2]: HDBAR + 144h
 Output Stream[3]: HDBAR + 164h

Default Value: 00000000h Size: 32 bits

Bit	Description
31:0	Link Position in Buffer — RO. Indicates the number of bytes that have been received off the link. This register will count from 0 to the value in the Cyclic Buffer Length register and then wrap to 0.

17.1.2.38 SDCBL—Stream Descriptor Cyclic Buffer Length Register (Intel® High Definition Audio Controller—D27:F0)

Memory Address: Input Stream[0]: HDBAR + 88h Attribute: R/W
 Input Stream[1]: HDBAR + A8h
 Input Stream[2]: HDBAR + C8h
 Input Stream[3]: HDBAR + E8h
 Output Stream[0]: HDBAR + 108h
 Output Stream[1]: HDBAR + 128h
 Output Stream[2]: HDBAR + 148h
 Output Stream[3]: HDBAR + 168h

Default Value: 00000000h Size: 32 bits

Bit	Description
31:0	Cyclic Buffer Length — R/W. Indicates the number of bytes in the complete cyclic buffer. This register represents an integer number of samples. Link Position in Buffer will be reset when it reaches this value. Software may only write to this register after Global Reset, Controller Reset, or Stream Reset has occurred. This value should be only modified when the RUN bit is 0. Once the RUN bit has been set to enable the engine, software must not write to this register until after the next reset is asserted, or transfer may be corrupted.

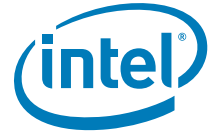

17.1.2.43 SDFMT—Stream Descriptor Format Register (Intel® High Definition Audio Controller—D27:F0)

Memory Address: Input Stream[0]: HDBAR + 92h Attribute: R/W
 Input Stream[1]: HDBAR + B2h
 Input Stream[2]: HDBAR + D2h
 Input Stream[3]: HDBAR + F2h
 Output Stream[0]: HDBAR + 112h
 Output Stream[1]: HDBAR + 132h
 Output Stream[2]: HDBAR + 152h
 Output Stream[3]: HDBAR + 172h

Default Value: 0000h Size: 16 bits

Bit	Description
15	Reserved
14	Sample Base Rate — R/W 0 = 48 kHz 1 = 44.1 kHz
13:11	Sample Base Rate Multiple — R/W 000 = 48 kHz, 44.1 kHz or less 001 = x2 (96 kHz, 88.2 kHz, 32 kHz) 010 = x3 (144 kHz) 011 = x4 (192 kHz, 176.4 kHz) Others = Reserved.
10:8	Sample Base Rate Divisor — R/W. 000 = Divide by 1(48 kHz, 44.1 kHz) 001 = Divide by 2 (24 kHz, 22.05 kHz) 010 = Divide by 3 (16 kHz, 32 kHz) 011 = Divide by 4 (11.025 kHz) 100 = Divide by 5 (9.6 kHz) 101 = Divide by 6 (8 kHz) 110 = Divide by 7 111 = Divide by 8 (6 kHz)
7	Reserved
6:4	Bits per Sample (BITS) — R/W. 000 = 8 bits. The data will be packed in memory in 8-bit containers on 16-bit boundaries 001 = 16 bits. The data will be packed in memory in 16-bit containers on 16-bit boundaries 010 = 20 bits. The data will be packed in memory in 32-bit containers on 32-bit boundaries 011 = 24 bits. The data will be packed in memory in 32-bit containers on 32-bit boundaries 100 = 32 bits. The data will be packed in memory in 32-bit containers on 32-bit boundaries Others = Reserved.
3:0	Number of Channels (CHAN) — R/W. Indicates number of channels in each frame of the stream. 0000 =1 0001 =2 1111 =16

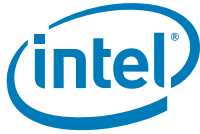

17.1.2.44 SDBDPL—Stream Descriptor Buffer Descriptor List Pointer Lower Base Address Register (Intel® High Definition Audio Controller—D27:F0)

Memory Address: Input Stream[0]: HDBAR + 98h Attribute: R/W,RO
 Input Stream[1]: HDBAR + B8h
 Input Stream[2]: HDBAR + D8h
 Input Stream[3]: HDBAR + F8h
 Output Stream[0]: HDBAR + 118h
 Output Stream[1]: HDBAR + 138h
 Output Stream[2]: HDBAR + 158h
 Output Stream[3]: HDBAR + 178h

Default Value: 00000000h Size: 32 bits

Bit	Description
31:7	Buffer Descriptor List Pointer Lower Base Address — R/W. Lower address of the Buffer Descriptor List. This value should only be modified when the RUN bit is 0, or DMA transfer may be corrupted.
6:0	Hardwired to 0 forcing alignment on 128-B boundaries.

17.1.2.45 SDBDPU—Stream Descriptor Buffer Descriptor List Pointer Upper Base Address Register (Intel® High Definition Audio Controller—D27:F0)

Memory Address: Input Stream[0]: HDBAR + 9Ch Attribute: R/W
 Input Stream[1]: HDBAR + BCh
 Input Stream[2]: HDBAR + DCh
 Input Stream[3]: HDBAR + FCh
 Output Stream[0]: HDBAR + 11Ch
 Output Stream[1]: HDBAR + 13Ch
 Output Stream[2]: HDBAR + 15Ch
 Output Stream[3]: HDBAR + 17Ch

Default Value: 00000000h Size: 32 bits

Bit	Description
31:0	Buffer Descriptor List Pointer Upper Base Address — R/W. Upper 32-bit address of the Buffer Descriptor List. This value should only be modified when the RUN bit is 0, or DMA transfer may be corrupted.



17.2 Integrated Digital Display Audio Registers and Verb IDs

The integrated digital display ports providing audio support provide the necessary registers and interfaces for software, per the Intel High Definition Audio Specification.

17.2.1 Configuration Default Register

The **Configuration Default** is a 32-bit register required in each Pin Widget. It is used by software as an aid in determining the configuration of jacks and devices attached to the codec. At the time the codec is first powered on, this register is internally loaded with default values indicating the typical system use of this particular pin/jack. After this initial loading, it is completely codec opaque, and its state, including any software writes into the register, must be preserved across reset events. Its state need not be preserved across power level changes.

Command Options

Table 17-3. Configuration Default

	Verb ID	Payload(8 Bits)	Response Bits (32 Bits)
Get	F1Ch	0	Config bits [31:0]
Set 1	71Ch	Config bits [7:0]	0
Set 2	71Dh	Config bits [15:8]	0
Set 3	71Eh	Config bits [23:16]	0
Set 4	71Fh	Config bits [31:24]	0

Data Structure

The Configuration Default register is defined as shown in [Table 17-4](#).

Table 17-4. Configuration Data Structure

Bits	Description
31:30	Port Connectivity
29:24	Location
23:20	Default Device
19:16	Connection Type
15:12	Color
11:8	Misc
7:4	Default Association
3:0	Sequence

Port Connectivity[1:0] indicates the external connectivity of the Pin Complex. Software can use this value to know what Pin Complexes are connected to jacks, internal devices, or not connected at all. The encodings of the Port Connectivity field are defined in [Table 17-5](#).

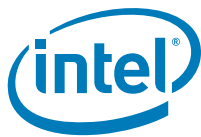

Location[5:0] indicates the physical location of the jack or device to which the pin complex is connected. This allows software to indicate, for instance, that the device is the “Front Panel Headphone Jack” as opposed to rear panel connections. The encodings of the Default Device field are defined in [Table 17-6](#).

The Location field is divided into two pieces, the upper bits [5:4] and the lower bits [3:0]. The upper bits [5:4] provide a gross location, such as “External” (on the primary system chassis, accessible to the user), “Internal” (on the motherboard, not accessible without opening the box), on a separate chassis (such as a mobile box), or other.

The lower bits [3:0] provide a geometric location, such as “Front,” “Left,” etc., or provide special encodings to indicate locations such as mobile lid mounted microphones. An “x” in [Table 17-6](#) indicates a combination that software should support. While all combinations are permitted, they are not all likely or expected.

Default Device[3:0] indicates the intended use of the jack or device. This can indicate either the label on the jack or the device that is hardwired to the port, as with integrated speakers and the like. The encodings of the Default Device field are defined in [Table 17-7](#).

Connection Type[3:0] indicates the type of physical connection, such as a 1/8-inch stereo jack or an optical digital connector, etc. Software can use this information to provide helpful user interface descriptions to the user or to modify reported codec capabilities based on the capabilities of the physical transport external to the codec. The encodings of the Connection Type field are defined in [Table 17-8](#).

Color[3:0] indicates the color of the physical jack for use by software. Encodings for the Color field are defined in [Table 17-9](#).

Misc[3:0] is a bit field used to indicate other information about the jack. Currently, only bit 0 is defined. If bit 0 is set, it indicates that the jack has no presence detect capability, so even if a Pin Complex indicates that the codec hardware supports the presence detect functionality on the jack, the external circuitry is not capable of supporting the functionality. The bit definitions for the Misc field are in [Table 17-10](#).

Default Association and **Sequence** are used together by software to group Pin Complexes (and therefore jacks) together into functional blocks to support multichannel operation. Software may assume that all jacks with the same association number are intended to be grouped together, for instance to provide six channel analog output. The Default Association can also be used by software to prioritize resource allocation in constrained situations. Lower Default Association values would be higher in priority for resources such as processing nodes or Input and Output Converters. Note that this is the default association only, and software can override this value if required, in particular if the user provides additional information about the particular system configuration. A value of 0000b is reserved and should not be used. Software may interpret this value to indicate that the Pin Configuration data has not been properly initialized. A value of 1111b is a special value indicating that the Association has the lowest priority. Multiple different Pin Complexes may share this value, and each is intended to be exposed as independent devices.

Sequence indicates the order of the jacks in the association group. The lowest numbered jack in the association group should be assigned the lowest numbered channels in the stream, etc. The numbers need not be sequential within the group, only the order matters. Sequence numbers within a set of Default Associations must be unique.



Table 17-5. Port Connectivity

Value	Value
00b	The Port Complex is connected to a jack
01b	No physical connection for port
10b	A fixed function device (integrated speaker, integrated mic etc) is attached
11b	Both a jack and an internal device attached

Table 17-6. Location

		Bits 5:4			
		00b External of Primary Chassis	01b Internal	10b Separate Chassis	11b Other
Bits 3:0	0h	X	X	X	X
	1h:Rear	X		X	
	2h:Front	X		X	
	3h:Left	X		X	
	4h:Right	X		X	
	5h:Top	X		X	
	6h:Bottom	X		X	X
	7h:Special	X (Rear Panel)	X (Riser)		X (Mobile Lid- Inside)
	8h:Special	X (Drive bay)	X (Digital Display)		X (Mobile Lid- Outside)
	9h:Special		X (ATAPI)		
Ah-Fh:Reserved					

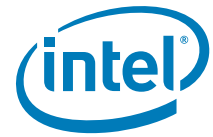

Table 17-7. Default Device

Default Device	Encoding
Line Out	0h
Speaker	1h
HP Out	2h
CD	3h
S/PDIF* Out	4h
Digital Other Side	5h
Modem Line side	6h
Modem Hand Set Side	7h
Line In	8h
AUX	9h
Mic In	Ah
Telephony	Bh
S/PDIF In	Ch
Digital Other In	Dh
Reserved	Eh
Other	Fh

Table 17-8. Connection Type

Connection Type	Encoding
Unknown	0h
1/8" Stereo/Mono	1h
1/4" Stereo/Mono	2h
ATAPI Internal	3h
RCA	4h
Optical	5h
Other Digital	6h
Other Analog	7h
Multichannel Analog (DIN)	8h
XLR/Professional	9h
RJ-11 (modem)	Ah
Combination	Bh
Other	Fh

**Table 17-9. Color**

Color	Encoding
Unknown	0h
Black	1h
Grey	2h
Blue	3h
Green	4h
Red	5h
Orange	6h
Yellow	7h
Purple	8h
Pink	9h
Reserved	A–Dh
White	Eh
Other	Fh

Table 17-10. Misc

Misc	Bit
Reserved	3
Reserved	2
Reserved	1

Config Default register needs to be programmed in BIOS to enable or disable the audio on the port. More details of the register and other audio registers' programming can be found in High Definition Audio Specification 1.0a at www.intel.com/standards.

§ §





18 SMBus Controller Registers (D31:F3)

18.1 PCI Configuration Registers (SMBus—D31:F3)

Table 18-1. SMBus Controller PCI Register Address Map (SMBus—D31:F3)

Offset	Mnemonic	Register Name	Default	Attribute
00h–01h	VID	Vendor Identification	8086	RO
02h–03h	DID	Device Identification	See register description	RO
04h–05h	PCICMD	PCI Command	0000h	R/W, RO
06h–07h	PCISTS	PCI Status	0280h	RO
08h	RID	Revision Identification	See register description	RO
09h	PI	Programming Interface	00h	RO
0Ah	SCC	Sub Class Code	05h	RO
0Bh	BCC	Base Class Code	0Ch	RO
10h	SMBMBAR0	Memory Base Address Register 0 (Bit 31:0)	00000004h	R/W, RO
14h	SMBMBAR1	Memory Based Address Register 1 (Bit 63:32)	00000000h	R/W
20h–23h	SMB_BASE	SMBus Base Address	00000001h	R/W, RO
2Ch–2Dh	SVID	Subsystem Vendor Identification	0000h	RO
2Eh–2Fh	SID	Subsystem Identification	0000h	R/WO
3Ch	INT_LN	Interrupt Line	00h	R/W
3Dh	INT_PN	Interrupt Pin	See register description	RO
40h	HOSTC	Host Configuration	00h	R/W

NOTE: Registers that are not shown should be treated as Reserved (See Section 9.2 for details).

18.1.1 VID—Vendor Identification Register (SMBus—D31:F3)

Address: 00h–01h

Attribute: RO

Default Value: 8086h

Size: 16 bits

Bit	Description
15:0	Vendor ID — RO. This is a 16-bit value assigned to Intel



18.1.2 DID—Device Identification Register (SMBus—D31:F3)

Address: 02h-03h Attribute: RO
Default Value: See bit description Size: 16 bits

Bit	Description
15:0	Device ID — RO. This is a 16-bit value assigned to the PCH SMBus controller. See the <i>Intel® 6 Series Chipset and Intel® C200 Series Chipset Specification Update</i> for the value of the DID Register.

18.1.3 PCICMD—PCI Command Register (SMBus—D31:F3)

Address: 04h-05h Attributes: RO, R/W
Default Value: 0000h Size: 16 bits

Bit	Description
15:11	Reserved
10	Interrupt Disable — R/W. 0 = Enable 1 = Disables SMBus to assert its PIRQB# signal.
9	Fast Back to Back Enable (FBE) — RO. Hardwired to 0.
8	SERR# Enable (SERR_EN) — R/W. 0 = Enables SERR# generation. 1 = Disables SERR# generation.
7	Wait Cycle Control (WCC) — RO. Hardwired to 0.
6	Parity Error Response (PER) — R/W. 0 = Disable 1 = Sets Detected Parity Error bit (D31:F3:06, bit 15) when a parity error is detected.
5	VGA Palette Snoop (VPS) — RO. Hardwired to 0.
4	Postable Memory Write Enable (PMWE) — RO. Hardwired to 0.
3	Special Cycle Enable (SCE) — RO. Hardwired to 0.
2	Bus Master Enable (BME) — RO. Hardwired to 0.
1	Memory Space Enable (MSE) — R/W. 0 = Disables memory mapped config space. 1 = Enables memory mapped config space.
0	I/O Space Enable (IOSE) — R/W. 0 = Disable 1 = Enables access to the SMBus I/O space registers as defined by the Base Address Register.



18.1.10 SMBMBAR1—D31_F3_SMBus Memory Base Address 1 Register (SMBus—D31:F3)

Address Offset: 14h–17h Attributes: R/W
 Default Value: 00000000h Size: 32 bits

Bit	Description
31:0	Base Address — R/W. Provides bits 63:32 system memory base address for the PCH SMB logic.

18.1.11 SMB_BASE—SMBus Base Address Register (SMBus—D31:F3)

Address Offset: 20–23h Attribute: R/W, RO
 Default Value: 00000001h Size: 32-bits

Bit	Description
31:16	Reserved — RO
15:5	Base Address — R/W. This field provides the 32-byte system I/O base address for the PCH's SMB logic.
4:1	Reserved — RO
0	IO Space Indicator — RO. Hardwired to 1 indicating that the SMB logic is I/O mapped.

18.1.12 SVID—Subsystem Vendor Identification Register (SMBus—D31:F2/F4)

Address Offset: 2Ch–2Dh Attribute: RO
 Default Value: 0000h Size: 16 bits
 Lockable: No Power Well: Core

Bit	Description
15:0	Subsystem Vendor ID (SVID) — RO. The SVID register, in combination with the Subsystem ID (SID) register, enables the operating system (OS) to distinguish subsystems from each other. The value returned by reads to this register is the same as that which was written by BIOS into the IDE SVID register. NOTE: Software can write to this register only once per core well reset. Writes should be done as a single 16-bit cycle.



18.1.13 SID—Subsystem Identification Register (SMBus—D31:F2/F4)

Address Offset: 2Eh-2Fh Attribute: R/WO
Default Value: 0000h Size: 16 bits
Lockable: No Power Well: Core

Bit	Description
15:0	Subsystem ID (SID) — R/WO. The SID register, in combination with the SVID register, enables the operating system (OS) to distinguish subsystems from each other. The value returned by reads to this register is the same as that which was written by BIOS into the IDE SID register. NOTE: Software can write to this register only once per core well reset. Writes should be done as a single 16-bit cycle.

18.1.14 INT_LN—Interrupt Line Register (SMBus—D31:F3)

Address Offset: 3Ch Attributes: R/W
Default Value: 00h Size: 8 bits

Bit	Description
7:0	Interrupt Line (INT_LN) — R/W. This data is not used by the PCH. It is to communicate to software the interrupt line that the interrupt pin is connected to PIRQB#.

18.1.15 INT_PN—Interrupt Pin Register (SMBus—D31:F3)

Address Offset: 3Dh Attributes: RO
Default Value: See description Size: 8 bits

Bit	Description
7:0	Interrupt PIN (INT_PN) — RO. This reflects the value of D31IP.SMIP in chipset configuration space.



18.2 SMBus I/O and Memory Mapped I/O Registers

The SMBus registers (see Table 18-2) can be accessed through I/O BAR or Memory BAR registers in PCI configuration space. The offsets are the same for both I/O and Memory Mapped I/O registers.

Table 18-2. SMBus I/O and Memory Mapped I/O Register Address Map

SMB_BASE + Offset	Mnemonic	Register Name	Default	Attribute
00h	HST_STS	Host Status	00h	R/WC, RO
02h	HST_CNT	Host Control	00h	R/W, WO
03h	HST_CMD	Host Command	00h	R/W
04h	XMIT_SLVA	Transmit Slave Address	00h	R/W
05h	HST_D0	Host Data 0	00h	R/W
06h	HST_D1	Host Data 1	00h	R/W
07h	HOST_BLOCK_DB	Host Block Data Byte	00h	R/W
08h	PEC	Packet Error Check	00h	R/W
09h	RCV_SLVA	Receive Slave Address	44h	R/W
0Ah–0Bh	SLV_DATA	Receive Slave Data	0000h	RO
0Ch	AUX_STS	Auxiliary Status	00h	R/WC, RO
0Dh	AUX_CTL	Auxiliary Control	00h	R/W
0Eh	SMLINK_PIN_CTL	SMLink Pin Control (TCO Compatible Mode)	See register description	R/W, RO
0Fh	SMBus_PIN_CTL	SMBus Pin Control	See register description	R/W, RO
10h	SLV_STS	Slave Status	00h	R/WC
11h	SLV_CMD	Slave Command	00h	R/W
14h	NOTIFY_DADDR	Notify Device Address	00h	RO
16h	NOTIFY_DLOW	Notify Data Low Byte	00h	RO
17h	NOTIFY_DHIGH	Notify Data High Byte	00h	RO



18.2.1 HST_STS—Host Status Register (SMBus—D31:F3)

Register Offset: SMB_BASE + 00h Attribute: R/WC, RO
 Default Value: 00h Size: 8-bits

All status bits are set by hardware and cleared by the software writing a one to the particular bit position. Writing a 0 to any bit position has no effect.

Bit	Description
7	<p>Byte Done Status (DS) — R/WC. 0 = Software can clear this by writing a 1 to it. 1 = Host controller received a byte (for Block Read commands) or if it has completed transmission of a byte (for Block Write commands) when the 32-byte buffer is not being used. Note that this bit will be set, even on the last byte of the transfer. This bit is not set when transmission is due to the LAN interface heartbeat. This bit has no meaning for block transfers when the 32-byte buffer is enabled.</p> <p>NOTE: When the last byte of a block message is received, the host controller will set this bit. However, it will not immediately set the INTR bit (bit 1 in this register). When the interrupt handler clears the DS bit, the message is considered complete, and the host controller will then set the INTR bit (and generate another interrupt). Thus, for a block message of n bytes, the PCH will generate n+1 interrupts. The interrupt handler needs to be implemented to handle these cases. When not using the 32 Byte Buffer, hardware will drive the SMBCLK signal low when the DS bit is set until SW clears the bit. This includes the last byte of a transfer. Software must clear the DS bit before it can clear the BUSY bit.</p>
6	<p>INUSE_STS — R/W. This bit is used as semaphore among various independent software threads that may need to use the PCH's SMBus logic, and has no other effect on hardware. 0 = After a full PCI reset, a read to this bit returns a 0. 1 = After the first read, subsequent reads will return a 1. A write of a 1 to this bit will reset the next read value to 0. Writing a 0 to this bit has no effect. Software can poll this bit until it reads a 0, and will then own the usage of the host controller.</p>
5	<p>SMBALERT_STS — R/WC. 0 = Interrupt or SMI# was not generated by SMBALERT#. Software clears this bit by writing a 1 to it. 1 = The source of the interrupt or SMI# was the SMBALERT# signal. This bit is only cleared by software writing a 1 to the bit position or by RSMRST# going low. If the signal is programmed as a GPIO, then this bit will never be set.</p>
4	<p>FAILED — R/WC. 0 = Software clears this bit by writing a 1 to it. 1 = The source of the interrupt or SMI# was a failed bus transaction. This bit is set in response to the KILL bit being set to terminate the host transaction.</p>
3	<p>BUS_ERR — R/WC. 0 = Software clears this bit by writing a 1 to it. 1 = The source of the interrupt of SMI# was a transaction collision.</p>
2	<p>DEV_ERR — R/WC. 0 = Software clears this bit by writing a 1 to it. The PCH will then deassert the interrupt or SMI#. 1 = The source of the interrupt or SMI# was due to one of the following:</p> <ul style="list-style-type: none"> • Invalid Command Field, • Unclaimed Cycle (host initiated), • Host Device Time-out Error.

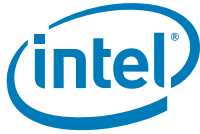

Bit	Description
1	<p>INTR — R/WC. This bit can only be set by termination of a command. INTR is not dependent on the INTREN bit (offset SMB_BASE + 02h, bit 0) of the Host controller register (offset 02h). It is only dependent on the termination of the command. If the INTREN bit is not set, then the INTR bit will be set, although the interrupt will not be generated. Software can poll the INTR bit in this non-interrupt case.</p> <p>0 = Software clears this bit by writing a 1 to it. The PCH then deasserts the interrupt or SMI#.</p> <p>1 = The source of the interrupt or SMI# was the successful completion of its last command.</p>
0	<p>HOST_BUSY — R/WC.</p> <p>0 = Cleared by the PCH when the current transaction is completed.</p> <p>1 = Indicates that the PCH is running a command from the host interface. No SMB registers should be accessed while this bit is set, except the BLOCK DATA BYTE Register. The BLOCK DATA BYTE Register can be accessed when this bit is set only when the SMB_CMD bits in the Host Control Register are programmed for Block command or I²C Read command. This is necessary in order to check the DONE_STS bit.</p>

18.2.2 HST_CNT—Host Control Register (SMBus—D31:F3)

Register Offset: SMB_BASE + 02h Attribute: R/W, WO
 Default Value: 00h Size: 8-bits

Note: A read to this register will clear the byte pointer of the 32-byte buffer.

Bit	Description
7	<p>PEC_EN — R/W.</p> <p>0 = SMBus host controller does not perform the transaction with the PEC phase appended.</p> <p>1 = Causes the host controller to perform the SMBus transaction with the Packet Error Checking phase appended. For writes, the value of the PEC byte is transferred from the PEC Register. For reads, the PEC byte is loaded in to the PEC Register. This bit must be written prior to the write in which the START bit is set.</p>
6	<p>START — WO.</p> <p>0 = This bit will always return 0 on reads. The HOST_BUSY bit in the Host Status register (offset 00h) can be used to identify when the PCH has finished the command.</p> <p>1 = Writing a 1 to this bit initiates the command described in the SMB_CMD field. All registers should be setup prior to writing a 1 to this bit position.</p>
5	<p>LAST_BYTE — WO. This bit is used for Block Read commands.</p> <p>1 = Software sets this bit to indicate that the next byte will be the last byte to be received for the block. This causes the PCH to send a NACK (instead of an ACK) after receiving the last byte.</p> <p>NOTE: Once the SECOND_TO_STS bit in TCO2_STS register (D31:F0, TCOBASE+6h, bit 1) is set, the LAST_BYTE bit also gets set. While the SECOND_TO_STS bit is set, the LAST_BYTE bit cannot be cleared. This prevents the PCH from running some of the SMBus commands (Block Read/Write, I²C Read, Block I²C Write).</p>



Bit	Description
4:2	<p>SMB_CMD — R/W. The bit encoding below indicates which command the PCH is to perform. If enabled, the PCH will generate an interrupt or SMI# when the command has completed. If the value is for a non-supported or reserved command, the PCH will set the device error (DEV_ERR) status bit (offset SMB_BASE + 00h, bit 2) and generate an interrupt when the START bit is set. The PCH will perform no command, and will not operate until DEV_ERR is cleared.</p> <p>000 = Quick: The slave address and read/write value (bit 0) are stored in the transmit slave address register.</p> <p>001 = Byte: This command uses the transmit slave address and command registers. Bit 0 of the slave address register determines if this is a read or write command.</p> <p>010 = Byte Data: This command uses the transmit slave address, command, and DATA0 registers. Bit 0 of the slave address register determines if this is a read or write command. If it is a read, the DATA0 register will contain the read data.</p> <p>011 = Word Data: This command uses the transmit slave address, command, DATA0 and DATA1 registers. Bit 0 of the slave address register determines if this is a read or write command. If it is a read, after the command completes, the DATA0 and DATA1 registers will contain the read data.</p> <p>100 = Process Call: This command uses the transmit slave address, command, DATA0 and DATA1 registers. Bit 0 of the slave address register determines if this is a read or write command. After the command completes, the DATA0 and DATA1 registers will contain the read data.</p> <p>101 = Block: This command uses the transmit slave address, command, DATA0 registers, and the Block Data Byte register. For block write, the count is stored in the DATA0 register and indicates how many bytes of data will be transferred. For block reads, the count is received and stored in the DATA0 register. Bit 0 of the slave address register selects if this is a read or write command. For writes, data is retrieved from the first n (where n is equal to the specified count) addresses of the SRAM array. For reads, the data is stored in the Block Data Byte register.</p> <p>110 = I²C Read: This command uses the transmit slave address, command, DATA0, DATA1 registers, and the Block Data Byte register. The read data is stored in the Block Data Byte register. The PCH continues reading data until the NAK is received.</p> <p>111 = Block Process: This command uses the transmit slave address, command, DATA0 and the Block Data Byte register. For block write, the count is stored in the DATA0 register and indicates how many bytes of data will be transferred. For block read, the count is received and stored in the DATA0 register. Bit 0 of the slave address register always indicate a write command. For writes, data is retrieved from the first m (where m is equal to the specified count) addresses of the SRAM array. For reads, the data is stored in the Block Data Byte register.</p> <p>NOTE: E32B bit in the Auxiliary Control register must be set for this command to work.</p>
1	<p>KILL — R/W.</p> <p>0 = Normal SMBus host controller functionality.</p> <p>1 = Kills the current host transaction taking place, sets the FAILED status bit, and asserts the interrupt (or SMI#). This bit, once set, must be cleared by software to allow the SMBus host controller to function normally.</p>
0	<p>INTREN — R/W.</p> <p>0 = Disable.</p> <p>1 = Enable the generation of an interrupt or SMI# upon the completion of the command.</p>



18.2.3 HST_CMD—Host Command Register (SMBus—D31:F3)

Register Offset: SMB_BASE + 03h Attribute: R/W
Default Value: 00h Size: 8 bits

Bit	Description
7:0	This 8-bit field is transmitted by the host controller in the command field of the SMBus protocol during the execution of any command.

18.2.4 XMIT_SLVA—Transmit Slave Address Register (SMBus—D31:F3)

Register Offset: SMB_BASE + 04h Attribute: R/W
Default Value: 00h Size: 8 bits

This register is transmitted by the host controller in the slave address field of the SMBus protocol.

Bit	Description
7:1	Address — R/W. This field provides a 7-bit address of the targeted slave.
0	RW — R/W. Direction of the host transfer. 0 = Write 1 = Read

18.2.5 HST_D0—Host Data 0 Register (SMBus—D31:F3)

Register Offset: SMB_BASE + 05h Attribute: R/W
Default Value: 00h Size: 8 bits

Bit	Description
7:0	Data0/Count — R/W. This field contains the 8-bit data sent in the DATA0 field of the SMBus protocol. For block write commands, this register reflects the number of bytes to transfer. This register should be programmed to a value between 1 and 32 for block counts. A count of 0 or a count above 32 will result in unpredictable behavior. The host controller does not check or log invalid block counts.

18.2.6 HST_D1—Host Data 1 Register (SMBus—D31:F3)

Register Offset: SMB_BASE + 06h Attribute: R/W
Default Value: 00h Size: 8 bits

Bit	Description
7:0	Data1 — R/W. This 8-bit register is transmitted in the DATA1 field of the SMBus protocol during the execution of any command.



18.2.7 Host_BLOCK_DB—Host Block Data Byte Register (SMBus—D31:F3)

Register Offset: SMB_BASE + 07h Attribute: R/W
 Default Value: 00h Size: 8 bits

Bit	Description
7:0	<p>Block Data (BDTA) — R/W. This is either a register, or a pointer into a 32-byte block array, depending upon whether the E32B bit is set in the Auxiliary Control register. When the E32B bit (offset SMB_BASE + 0Dh, bit 1) is cleared, this is a register containing a byte of data to be sent on a block write or read from on a block read. When the E32B bit is set, reads and writes to this register are used to access the 32-byte block data storage array. An internal index pointer is used to address the array, which is reset to 0 by reading the HCTL register (offset 02h). The index pointer then increments automatically upon each access to this register. The transfer of block data into (read) or out of (write) this storage array during an SMBus transaction always starts at index address 0.</p> <p>When the E2B bit is set, for writes, software will write up to 32-bytes to this register as part of the setup for the command. After the Host controller has sent the Address, Command, and Byte Count fields, it will send the bytes in the SRAM pointed to by this register.</p> <p>When the E2B bit is cleared for writes, software will place a single byte in this register. After the host controller has sent the address, command, and byte count fields, it will send the byte in this register. If there is more data to send, software will write the next series of bytes to the SRAM pointed to by this register and clear the DONE_STS bit. The controller will then send the next byte. During the time between the last byte being transmitted to the next byte being transmitted, the controller will insert wait-states on the interface.</p> <p>When the E2B bit is set for reads, after receiving the byte count into the Data0 register, the first series of data bytes go into the SRAM pointed to by this register. If the byte count has been exhausted or the 32-byte SRAM has been filled, the controller will generate an SMI# or interrupt (depending on configuration) and set the DONE_STS bit. Software will then read the data. During the time between when the last byte is read from the SRAM to when the DONE_STS bit is cleared, the controller will insert wait-states on the interface.</p>

18.2.8 PEC—Packet Error Check (PEC) Register (SMBus—D31:F3)

Register Offset: SMB_BASE + 08h Attribute: R/W
 Default Value: 00h Size: 8 bits

Bit	Description
7:0	<p>PEC_DATA — R/W. This 8-bit register is written with the 8-bit CRC value that is used as the SMBus PEC data prior to a write transaction. For read transactions, the PEC data is loaded from the SMBus into this register and is then read by software. Software must ensure that the INUSE_STS bit is properly maintained to avoid having this field overwritten by a write transaction following a read transaction.</p>

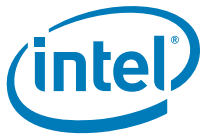

18.2.9 RCV_SLVA—Receive Slave Address Register (SMBus—D31:F3)

Register Offset: SMB_BASE + 09h Attribute: R/W
Default Value: 44h Size: 8 bits
Lockable: No Power Well: Resume

Bit	Description
7	Reserved
6:0	SLAVE_ADDR — R/W. This field is the slave address that the PCH decodes for read and write cycles. the default is not 0, so the SMBus Slave Interface can respond even before the processor comes up (or if the processor is dead). This register is cleared by RSMRST#, but not by PLTRST#.

18.2.10 SLV_DATA—Receive Slave Data Register (SMBus—D31:F3)

Register Offset: SMB_BASE + 0Ah–0Bh Attribute: RO
Default Value: 0000h Size: 16 bits
Lockable: No Power Well: Resume

This register contains the 16-bit data value written by the external SMBus master. The processor can then read the value from this register. This register is reset by RSMRST#, but not PLTRST#.

Bit	Description
15:8	Data Message Byte 1 (DATA_MSG1) — RO. See Section 5.20.7 for a discussion of this field.
7:0	Data Message Byte 0 (DATA_MSG0) — RO. See Section 5.20.7 for a discussion of this field.

18.2.11 AUX_STS—Auxiliary Status Register (SMBus—D31:F3)

Register Offset: SMB_BASE + 0Ch Attribute: R/WC, RO
Default Value: 00h Size: 8 bits
Lockable: No Power Well: Resume

Bit	Description
7:2	Reserved
1	SMBus TCO Mode (STCO) — RO. This bit reflects the strap setting of TCO compatible mode versus Advanced TCO mode. 0 = The PCH is in the compatible TCO mode. 1 = The PCH is in the advanced TCO mode.
0	CRC Error (CRCE) — R/WC. 0 = Software clears this bit by writing a 1 to it. 1 = This bit is set if a received message contained a CRC error. When this bit is set, the DERR bit of the host status register will also be set. This bit will be set by the controller if a software abort occurs in the middle of the CRC portion of the cycle or an abort happens after the PCH has received the final data bit transmitted by an external slave.



18.2.12 AUX_CTL—Auxiliary Control Register (SMBus—D31:F3)

Register Offset: SMB_BASE + 0Dh Attribute: R/W
 Default Value: 00h Size: 8 bits
 Lockable: No Power Well: Resume

Bit	Description
7:2	Reserved
1	Enable 32-Byte Buffer (E32B) — R/W. 0 = Disable. 1 = Enable. When set, the Host Block Data register is a pointer into a 32-byte buffer, as opposed to a single register. This enables the block commands to transfer or receive up to 32-bytes before the PCH generates an interrupt.
0	Automatically Append CRC (AAC) — R/W. 0 = The PCH will Not automatically append the CRC. 1 = The PCH will automatically append the CRC. This bit must not be changed during SMBus transactions or undetermined behavior will result. It should be programmed only once during the lifetime of the function.

18.2.13 SMLINK_PIN_CTL—SMLink Pin Control Register (SMBus—D31:F3)

Register Offset: SMB_BASE + 0Eh Attribute: R/W, RO
 Default Value: See below Size: 8 bits

Note: This register is in the resume well and is reset by RSMRST#.

This register is only applicable in the TCO compatible mode.

Bit	Description
7:3	Reserved
2	SMLINK_CLK_CTL — R/W. 0 = The PCH will drive the SMLink0 pin low, independent of what the other SMLink logic would otherwise indicate for the SMLink0 pin. 1 = The SMLink0 pin is not overdriven low. The other SMLink logic controls the state of the pin. (Default)
1	SMLINK1_CUR_STS — RO. This read-only bit has a default value that is dependent on an external signal level. This pin returns the value on the SMLink1 pin. This allows software to read the current state of the pin. 0 = Low 1 = High
0	SMLINK0_CUR_STS — RO. This read-only bit has a default value that is dependent on an external signal level. This pin returns the value on the SMLink0 pin. This allows software to read the current state of the pin. 0 = Low 1 = High



18.2.14 SMBus_PIN_CTL—SMBus Pin Control Register (SMBus—D31:F3)

Register Offset: SMB_BASE + 0Fh Attribute: R/W, RO
 Default Value: See below Size: 8 bits

Note: This register is in the resume well and is reset by RSMRST#.

Bit	Description
7:3	Reserved
2	SMBCLK_CTL — R/W. 1 = The SMBCLK pin is not overdriven low. The other SMBus logic controls the state of the pin. 0 = The PCH drives the SMBCLK pin low, independent of what the other SMB logic would otherwise indicate for the SMBCLK pin. (Default)
1	SMBDATA_CUR_STS — RO. This read-only bit has a default value that is dependent on an external signal level. This pin returns the value on the SMBDATA pin. This allows software to read the current state of the pin. 0 = Low 1 = High
0	SMBCLK_CUR_STS — RO. This read-only bit has a default value that is dependent on an external signal level. This pin returns the value on the SMBCLK pin. This allows software to read the current state of the pin. 0 = Low 1 = High

18.2.15 SLV_STS—Slave Status Register (SMBus—D31:F3)

Register Offset: SMB_BASE + 10h Attribute: R/WC
 Default Value: 00h Size: 8 bits

Note: This register is in the resume well and is reset by RSMRST#.

All bits in this register are implemented in the 64 kHz clock domain. Therefore, software must poll this register until a write takes effect before assuming that a write has completed internally.

Bit	Description
7:1	Reserved
0	HOST_NOTIFY_STS — R/WC. The PCH sets this bit to a 1 when it has completely received a successful Host Notify Command on the SMBus pins. Software reads this bit to determine that the source of the interrupt or SMI# was the reception of the Host Notify Command. Software clears this bit after reading any information needed from the Notify address and data registers by writing a 1 to this bit. Note that the PCH will allow the Notify Address and Data registers to be over-written once this bit has been cleared. When this bit is 1, the PCH will NACK the first byte (host address) of any new "Host Notify" commands on the SMBus pins. Writing a 0 to this bit has no effect.



18.2.16 SLV_CMD—Slave Command Register (SMBus—D31:F3)

Register Offset: SMB_BASE + 11h Attribute: R/W
 Default Value: 00h Size: 8 bits

Note: This register is in the resume well and is reset by RSMRST#.

Bit	Description
7:2	Reserved
2	<p>SMBALERT_DIS — R/W.</p> <p>0 = Allows the generation of the interrupt or SMI#.</p> <p>1 = Software sets this bit to block the generation of the interrupt or SMI# due to the SMBALERT# source. This bit is logically inverted and ANDed with the SMBALERT_STS bit (offset SMB_BASE + 00h, bit 5). The resulting signal is distributed to the SMI# and/or interrupt generation logic. This bit does not effect the wake logic.</p>
1	<p>HOST_NOTIFY_WKEN — R/W. Software sets this bit to 1 to enable the reception of a Host Notify command as a wake event. When enabled this event is "OR'd" in with the other SMBus wake events and is reflected in the SMB_WAK_STS bit of the General Purpose Event 0 Status register.</p> <p>0 = Disable 1 = Enable</p>
0	<p>HOST_NOTIFY_INTREN — R/W. Software sets this bit to 1 to enable the generation of interrupt or SMI# when HOST_NOTIFY_STS (offset SMB_BASE + 10h, bit 0) is 1. This enable does not affect the setting of the HOST_NOTIFY_STS bit. When the interrupt is generated, either PIRQB# or SMI# is generated, depending on the value of the SMB_SMI_EN bit (D31:F3:40h, bit 1). If the HOST_NOTIFY_STS bit is set when this bit is written to a 1, then the interrupt (or SMI#) will be generated. The interrupt (or SMI#) is logically generated by AND'ing the STS and INTREN bits.</p> <p>0 = Disable 1 = Enable</p>

18.2.17 NOTIFY_DADDR—Notify Device Address Register (SMBus—D31:F3)

Register Offset: SMB_BASE + 14h Attribute: RO
 Default Value: 00h Size: 8 bits

Note: This register is in the resume well and is reset by RSMRST#.

Bit	Description
7:1	<p>DEVICE_ADDRESS — RO. This field contains the 7-bit device address received during the Host Notify protocol of the SMBus 2.0 Specification. Software should only consider this field valid when the HOST_NOTIFY_STS bit (D31:F3:SMB_BASE +10, bit 0) is set to 1.</p>
0	Reserved



18.2.18 NOTIFY_DLOW—Notify Data Low Byte Register (SMBus—D31:F3)

Register Offset: SMB_BASE + 16h Attribute: RO
Default Value: 00h Size: 8 bits

Note: This register is in the resume well and is reset by RSMRST#.

Bit	Description
7:0	DATA_LOW_BYTE — RO. This field contains the first (low) byte of data received during the Host Notify protocol of the SMBus 2.0 specification. Software should only consider this field valid when the HOST_NOTIFY_STS bit (D31:F3:SMB_BASE +10, bit 0) is set to 1.

18.2.19 NOTIFY_DHIGH—Notify Data High Byte Register (SMBus—D31:F3)

Register Offset: SMB_BASE + 17h Attribute: RO
Default Value: 00h Size: 8 bits

Note: This register is in the resume well and is reset by RSMRST#.

Bit	Description
7:0	DATA_HIGH_BYTE — RO. This field contains the second (high) byte of data received during the Host Notify protocol of the SMBus 2.0 specification. Software should only consider this field valid when the HOST_NOTIFY_STS bit (D31:F3:SMB_BASE +10, bit 0) is set to 1.

§ §



19 PCI Express* Configuration Registers

19.1 PCI Express* Configuration Registers (PCI Express*—D28:F0/F1/F2/F3/F4/F5/F6/F7)

Note: This section assumes the default PCI Express Function Number-to-Root Port mapping is used. Function numbers for a given root port are assignable through the Root Port Function Number and Hide for PCI Express Root Ports register (RCBA+0404h).

Note: Register address locations that are not shown in Table 19-1, should be treated as Reserved.

Table 19-1. PCI Express* Configuration Registers Address Map (PCI Express*—D28:F0/F1/F2/F3/F4/F5/F6/F7) (Sheet 1 of 3)

Offset	Mnemonic	Register Name	Function 0-7 Default	Attribute
00h-01h	VID	Vendor Identification	8086h	RO
02h-03h	DID	Device Identification	See register description	RO
04h-05h	PCICMD	PCI Command	0000h	R/W, RO
06h-07h	PCISTS	PCI Status	0010h	R/WC, RO
08h	RID	Revision Identification	See register description	RO
09h	PI	Programming Interface	00h	RO
0Ah	SCC	Sub Class Code	04h	RO
0Bh	BCC	Base Class Code	06h	RO
0Ch	CLS	Cache Line Size	00h	R/W
0Dh	PLT	Primary Latency Timer	00h	RO
0Eh	HEADTYP	Header Type	81h	RO
18h-1Ah	BNUM	Bus Number	000000h	R/W
1Bh	SLT	Secondary Latency Timer	00h	RO
1Ch-1Dh	IOBL	I/O Base and Limit	0000h	R/W, RO
1Eh-1Fh	SSTS	Secondary Status Register	0000h	R/WC
20h-23h	MBL	Memory Base and Limit	00000000h	R/W
24h-27h	PMBL	Prefetchable Memory Base and Limit	00010001h	R/W, RO
28h-2Bh	PMBU32	Prefetchable Memory Base Upper 32 Bits	00000000h	R/W
2Ch-2Fh	PMLU32	Prefetchable Memory Limit Upper 32 Bits	00000000h	R/W
34h	CAPP	Capabilities List Pointer	40h	RO
3Ch-3Dh	INTR	Interrupt Information	See bit description	R/W, RO

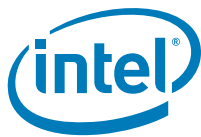

Table 19-1. PCI Express* Configuration Registers Address Map (PCI Express*—D28:F0/F1/F2/F3/F4/F5/F6/F7) (Sheet 2 of 3)

Offset	Mnemonic	Register Name	Function 0-7 Default	Attribute
3Eh-3Fh	BCTRL	Bridge Control Register	0000h	R/W
40h-41h	CLIST	Capabilities List	8010h	RO
42h-43h	XCAP	PCI Express* Capabilities	0041h	R/WO, RO
44h-47h	DCAP	Device Capabilities	00000FE0h	RO
48h-49h	DCTL	Device Control	0000h	R/W, RO
4Ah-4Bh	DSTS	Device Status	0010h	R/WC, RO
4Ch-4Fh	LCAP	Link Capabilities	See bit description	RO, R/WO
50h-51h	LCTL	Link Control	0000h	R/W, RO
52h-53h	LSTS	Link Status	See bit description	RO
54h-57h	SLCAP	Slot Capabilities Register	00000060h	R/WO, RO
58h-59h	SLCTL	Slot Control	0000h	R/W, RO
5Ah-5Bh	SLSTS	Slot Status	0000h	R/WC, RO
5Ch-5Dh	RCTL	Root Control	0000h	R/W
60h-63h	RSTS	Root Status	00000000h	R/WC, RO
64h-67h	DCAP2	Device Capabilities 2 Register	00000016h	RO
68h-69h	DCTL2	Device Control 2 Register	0000h	R/W, RO
70h-71h	LCTL2	Link Control 2 Register	0001h	R/W
72h-73h	LSTS2	Link Status 2 Register	0000h	R/W
80h-81h	MID	Message Signaled Interrupt Identifiers	9005h	RO
82h-83h	MC	Message Signaled Interrupt Message Control	0000h	R/W, RO
84h-87h	MA	Message Signaled Interrupt Message Address	00000000h	R/W
88h-89h	MD	Message Signaled Interrupt Message Data	0000h	R/W
90h-91h	SVCAP	Subsystem Vendor Capability	A00Dh	RO
94h-97h	SVID	Subsystem Vendor Identification	00000000h	R/WO
A0h-A1h	PMCAP	Power Management Capability	0001h	RO
A2h-A3h	PMC	PCI Power Management Capability	C802h	RO
A4h-A7h	PMCS	PCI Power Management Control and Status	00000000h	R/W, RO
D4h-D7h	MPC2	Miscellaneous Port Configuration 2	00000000h	R/W, RO
D8h-DBh	MPC	Miscellaneous Port Configuration	08110000h	R/W
DCh-DFh	SMSCS	SMI/SCI Status	00000000h	R/WC
E1h	RPDCGEN	Rort Port Dynamic Clock Gating Enable	00h	R/W



19.1.3 PCICMD—PCI Command Register (PCI Express*—D28:F0/F1/F2/F3/F4/F5/F6/F7/F6/F7)

Address Offset: 04h–05h
Default Value: 0000h

Attribute: R/W, RO
Size: 16 bits

Bit	Description
15:11	Reserved
10	<p>Interrupt Disable — R/W. This disables pin-based INTx# interrupts on enabled Hot-Plug and power management events. This bit has no effect on MSI operation.</p> <p>0 = Internal INTx# messages are generated if there is an interrupt for Hot-Plug or power management and MSI is not enabled.</p> <p>1 = Internal INTx# messages will not be generated.</p> <p>This bit does not affect interrupt forwarding from devices connected to the root port. Assert_INTx and Deassert_INTx messages will still be forwarded to the internal interrupt controllers if this bit is set.</p>
9	Fast Back to Back Enable (FBE) — Reserved per the <i>PCI Express* Base Specification</i> .
8	<p>SERR# Enable (SEE) — R/W.</p> <p>0 = Disable.</p> <p>1 = Enables the root port to generate an SERR# message when PSTS.SSE is set.</p>
7	Wait Cycle Control (WCC) — Reserved per the <i>PCI Express Base Specification</i> .
6	<p>Parity Error Response (PER) — R/W.</p> <p>0 = Disable.</p> <p>1 = Indicates that the device is capable of reporting parity errors as a master on the backbone.</p>
5	VGA Palette Snoop (VPS) — Reserved per the <i>PCI Express* Base Specification</i> .
4	Postable Memory Write Enable (PMWE) — Reserved per the <i>PCI Express* Base Specification</i> .
3	Special Cycle Enable (SCE) — Reserved per the <i>PCI Express* Base Specification</i> .
2	<p>Bus Master Enable (BME) — R/W.</p> <p>0 = Disable. Memory and I/O requests received at a Root Port must be handled as Unsupported Requests.</p> <p>1 = Enable. Allows the root port to forward Memory and I/O Read/Write cycles onto the backbone from a PCI Express* device.</p> <p>NOTE: This bit does not affect forwarding of completions in either upstream or downstream direction nor controls forwarding of requests other than memory or I/O</p>
1	<p>Memory Space Enable (MSE) — R/W.</p> <p>0 = Disable. Memory cycles within the range specified by the memory base and limit registers are master aborted on the backbone.</p> <p>1 = Enable. Allows memory cycles within the range specified by the memory base and limit registers can be forwarded to the PCI Express device.</p>
0	<p>I/O Space Enable (IOSE) — R/W. This bit controls access to the I/O space registers.</p> <p>0 = Disable. I/O cycles within the range specified by the I/O base and limit registers are master aborted on the backbone.</p> <p>1 = Enable. Allows I/O cycles within the range specified by the I/O base and limit registers can be forwarded to the PCI Express device.</p>



19.1.4 PCISTS—PCI Status Register (PCI Express*—D28:F0/F1/F2/F3/F4/F5/F6/F7/F6/F7)

Address Offset: 06h-07h
Default Value: 0010h

Attribute: R/WC, RO
Size: 16 bits

Bit	Description
15	Detected Parity Error (DPE) — R/WC. 0 = No parity error detected. 1 = Set when the root port receives a command or data from the backbone with a parity error. This is set even if PCIMD.PER (D28:F0/F1/F2/F3:04, bit 6) is not set.
14	Signaled System Error (SSE) — R/WC. 0 = No system error signaled. 1 = Set when the root port signals a system error to the internal SERR# logic.
13	Received Master Abort (RMA) — R/WC. 0 = Root port has not received a completion with unsupported request status from the backbone. 1 = Set when the root port receives a completion with unsupported request status from the backbone.
12	Received Target Abort (RTA) — R/WC. 0 = Root port has not received a completion with completer abort from the backbone. 1 = Set when the root port receives a completion with completer abort from the backbone.
11	Signaled Target Abort (STA) — R/WC. 0 = No target abort received. 1 = Set whenever the root port forwards a target abort received from the downstream device onto the backbone.
10:9	DEVSEL# Timing Status (DEV_STS) — Reserved per the <i>PCI Express* Base Specification</i> .
8	Master Data Parity Error Detected (DPED) — R/WC. 0 = No data parity error received. 1 = Set when the root port receives a completion with a data parity error on the backbone and PCIMD.PER (D28:F0/F1/F2/F3:04, bit 6) is set.
7	Fast Back to Back Capable (FB2BC) — Reserved per the <i>PCI Express* Base Specification</i> .
6	Reserved
5	66 MHz Capable — Reserved per the <i>PCI Express* Base Specification</i> .
4	Capabilities List — RO. Hardwired to 1. Indicates the presence of a capabilities list.
3	Interrupt Status — RO. Indicates status of Hot-Plug and power management interrupts on the root port that result in INTx# message generation. 0 = Interrupt is deasserted. 1 = Interrupt is asserted. This bit is not set if MSI is enabled. If MSI is not enabled, this bit is set regardless of the state of PCICMD.Interrupt Disable bit (D28:F0/F1/F2/F3/F4/F5/F6/F7/F6/F7:04h:bit 10).
2:0	Reserved



19.1.12 BNUM—Bus Number Register (PCI Express*—D28:F0/F1/F2/F3/F4/F5/F6/F7/F6/F7)

Address Offset: 18–1Ah Attribute: R/W
Default Value: 000000h Size: 24 bits

Bit	Description
23:16	Subordinate Bus Number (SBBN) — R/W. Indicates the highest PCI bus number below the bridge.
15:8	Secondary Bus Number (SCBN) — R/W. Indicates the bus number the port.
7:0	Primary Bus Number (PBN) — R/W. Indicates the bus number of the backbone.

19.1.13 SLT—Secondary Latency Timer Register (PCI Express*—D28:F0/F1/F2/F3/F4/F5/F6/F7/F6/F7)

Address Offset: 1Bh Attribute: RO
Default Value: 00h Size: 8 bits

Bit	Description
7:0	Secondary Latency Timer — Reserved for a Root Port per the <i>PCI Express* Base Specification</i> .

19.1.14 IOBL—I/O Base and Limit Register (PCI Express*—D28:F0/F1/F2/F3/F4/F5/F6/F7/F6/F7)

Address Offset: 1Ch–1Dh Attribute: R/W, RO
Default Value: 0000h Size: 16 bits

Bit	Description
15:12	I/O Limit Address (IOLA) — R/W. I/O Base bits corresponding to address lines 15:12 for 4-KB alignment. Bits 11:0 are assumed to be padded to FFFh.
11:8	I/O Limit Address Capability (IOLC) — RO. Indicates that the bridge does not support 32-bit I/O addressing.
7:4	I/O Base Address (IOBA) — R/W. I/O Base bits corresponding to address lines 15:12 for 4-KB alignment. Bits 11:0 are assumed to be padded to 000h.
3:0	I/O Base Address Capability (IOBC) — RO. Indicates that the bridge does not support 32-bit I/O addressing.



19.1.15 SSTS—Secondary Status Register (PCI Express*—D28:F0/F1/F2/F3/F4/F5/F6/F7/F6/F7)

Address Offset: 1Eh–1Fh
Default Value: 0000h

Attribute: R/WC
Size: 16 bits

Bit	Description
15	Detected Parity Error (DPE) — R/WC. 0 = No error. 1 = The port received a poisoned TLP.
14	Received System Error (RSE) — R/WC. 0 = No error. 1 = The port received an ERR_FATAL or ERR_NONFATAL message from the device.
13	Received Master Abort (RMA) — R/WC. 0 = Unsupported Request not received. 1 = The port received a completion with “Unsupported Request” status from the device.
12	Received Target Abort (RTA) — R/WC. 0 = Completion Abort not received. 1 = The port received a completion with “Completion Abort” status from the device.
11	Signaled Target Abort (STA) — R/WC. 0 = Completion Abort not sent. 1 = The port generated a completion with “Completion Abort” status to the device.
10:9	Secondary DEVSEL# Timing Status (SDTS): Reserved per <i>PCI Express* Base Specification</i> .
8	Data Parity Error Detected (DPD) — R/WC. 0 = Conditions below did not occur. 1 = Set when the BCTRL.PERE (D28:F0/F1/F2/F3/F4/F5:3E: bit 0) is set, and either of the following two conditions occurs: <ul style="list-style-type: none"> •Port receives completion marked poisoned. •Port poisons a write request to the secondary side.
7	Secondary Fast Back to Back Capable (SFBC): Reserved per <i>PCI Express* Base Specification</i> .
6	Reserved
5	Secondary 66 MHz Capable (SC66): Reserved per <i>PCI Express* Base Specification</i> .
4:0	Reserved

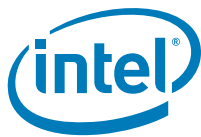

19.1.16 MBL—Memory Base and Limit Register (PCI Express*—D28:F0/F1/F2/F3/F4/F5/F6/F7/F6/F7)

Address Offset: 20h–23h Attribute: R/W
 Default Value: 00000000h Size: 32 bits

Accesses that are within the ranges specified in this register will be sent to the attached device if CMD.MSE (D28:F0/F1/F2/F3/F4/F5/F6/F7/F6/F7:04:bit 1) is set. Accesses from the attached device that are outside the ranges specified will be forwarded to the backbone if CMD.BME (D28:F0/F1/F2/F3/F4/F5/F6/F7/F6/F7:04:bit 2) is set. The comparison performed is $MB \geq AD[31:20] \leq ML$.

Bit	Description
31:20	Memory Limit (ML) — R/W. These bits are compared with bits 31:20 of the incoming address to determine the upper 1-MB aligned value of the range.
19:16	Reserved
15:4	Memory Base (MB) — R/W. These bits are compared with bits 31:20 of the incoming address to determine the lower 1-MB aligned value of the range.
3:0	Reserved

19.1.17 PMBL—Prefetchable Memory Base and Limit Register (PCI Express*—D28:F0/F1/F2/F3/F4/F5/F6/F7/F6/F7)

Address Offset: 24h–27h Attribute: R/W, RO
 Default Value: 00010001h Size: 32 bits

Accesses that are within the ranges specified in this register will be sent to the device if CMD.MSE (D28:F0/F1/F2/F3/F4/F5/F6/F7/F6/F7:04, bit 1) is set. Accesses from the device that are outside the ranges specified will be forwarded to the backbone if CMD.BME (D28:F0/F1/F2/F3/F4/F5/F6/F7/F6/F7:04, bit 2) is set. The comparison performed is $PMBU32:PMB \geq AD[63:32]:AD[31:20] \leq PMLU32:PML$.

Bit	Description
31:20	Prefetchable Memory Limit (PML) — R/W. These bits are compared with bits 31:20 of the incoming address to determine the upper 1-MB aligned value of the range.
19:16	64-bit Indicator (I64L) — RO. Indicates support for 64-bit addressing
15:4	Prefetchable Memory Base (PMB) — R/W. These bits are compared with bits 31:20 of the incoming address to determine the lower 1-MB aligned value of the range.
3:0	64-bit Indicator (I64B) — RO. Indicates support for 64-bit addressing



19.1.21 INTR—Interrupt Information Register (PCI Express*—D28:F0/F1/F2/F3/F4/F5/F6/F7/F6/F7)

Address Offset: 3Ch–3Dh Attribute: R/W, RO
Default Value: See bit description Size: 16 bits
Function Level Reset: No (Bits 7:0 only)

Bit	Description																		
15:8	<p>Interrupt Pin (IPIN) — RO. Indicates the interrupt pin driven by the root port. At reset, this register takes on the following values that reflect the reset state of the D28IP register in chipset config space:</p> <table border="1"><thead><tr><th>Port</th><th>Reset Value</th></tr></thead><tbody><tr><td>1</td><td>D28IP.P1IP</td></tr><tr><td>2</td><td>D28IP.P2IP</td></tr><tr><td>3</td><td>D28IP.P3IP</td></tr><tr><td>4</td><td>D28IP.P4IP</td></tr><tr><td>5</td><td>D28IP.P5IP</td></tr><tr><td>6</td><td>D28IP.P6IP</td></tr><tr><td>7</td><td>D28IP.P7IP</td></tr><tr><td>8</td><td>D28IP.P8IP</td></tr></tbody></table> <p>NOTE: The value that is programmed into D28IP is always reflected in this register.</p>	Port	Reset Value	1	D28IP.P1IP	2	D28IP.P2IP	3	D28IP.P3IP	4	D28IP.P4IP	5	D28IP.P5IP	6	D28IP.P6IP	7	D28IP.P7IP	8	D28IP.P8IP
Port	Reset Value																		
1	D28IP.P1IP																		
2	D28IP.P2IP																		
3	D28IP.P3IP																		
4	D28IP.P4IP																		
5	D28IP.P5IP																		
6	D28IP.P6IP																		
7	D28IP.P7IP																		
8	D28IP.P8IP																		
7:0	<p>Interrupt Line (ILINE) — R/W. Default = 00h. Software written value to indicate which interrupt line (vector) the interrupt is connected to. No hardware action is taken on this register. These bits are not reset by FLR.</p>																		



19.1.22 BCTRL—Bridge Control Register (PCI Express*—D28:F0/F1/F2/F3/F4/F5/F6/F7/F6/F7)

Address Offset: 3Eh–3Fh
Default Value: 0000h

Attribute: R/W
Size: 16 bits

Bit	Description
15:12	Reserved
11	Discard Timer SERR# Enable (DTSE): Reserved per <i>PCI Express* Base Specification</i> , Revision 1.0a
10	Discard Timer Status (DTS): Reserved per <i>PCI Express* Base Specification</i> , Revision 1.0a.
9	Secondary Discard Timer (SDT): Reserved per <i>PCI Express* Base Specification</i> , Revision 1.0a.
8	Primary Discard Timer (PDT): Reserved per <i>PCI Express* Base Specification</i> , Revision 1.0a.
7	Fast Back to Back Enable (FBE): Reserved per <i>PCI Express* Base Specification</i> , Revision 1.0a.
6	Secondary Bus Reset (SBR) — R/W. Triggers a hot reset on the PCI Express* port.
5	Master Abort Mode (MAM): Reserved per Express specification.
4	VGA 16-Bit Decode (V16) — R/W. 0 = VGA range is enabled. 1 = The I/O aliases of the VGA range (see BCTRL:VE definition below), are not enabled, and only the base I/O ranges can be decoded.
3	VGA Enable (VE) — R/W. 0 = The ranges below will not be claimed off the backbone by the root port. 1 = The following ranges will be claimed off the backbone by the root port: <ul style="list-style-type: none"> Memory ranges A0000h-BFFFFh I/O ranges 3B0h – 3BBh and 3C0h – 3DFh, and all aliases of bits 15:10 in any combination of 1s
2	ISA Enable (IE) — R/W. This bit only applies to I/O addresses that are enabled by the I/O Base and I/O Limit registers and are in the first 64 KB of PCI I/O space. 0 = The root port will not block any forwarding from the backbone as described below. 1 = The root port will block any forwarding from the backbone to the device of I/O transactions addressing the last 768 bytes in each 1-KB block (offsets 100h to 3FFh).
1	SERR# Enable (SE) — R/W. 0 = The messages described below are not forwarded to the backbone. 1 = ERR_COR, ERR_NONFATAL, and ERR_FATAL messages received are forwarded to the backbone.
0	Parity Error Response Enable (PERE) — R/W. When set, 0 = Poisoned write TLPs and completions indicating poisoned TLPs will not set the SSTS.DPD (D28:F0/F1/F2/F3/F4/F5/F6/F7:1E, bit 8). 1 = Poisoned write TLPs and completions indicating poisoned TLPs will set the SSTS.DPD (D28:F0/F1/F2/F3/F4/F5/F6/F7:1E, bit 8).



19.1.28 LCAP—Link Capabilities Register (PCI Express*—D28:F0/F1/F2/F3/F4/F5/F6/F7)

Address Offset: 4Ch–4Fh Attribute: R/WO, RO
 Default Value: See bit description Size: 32 bits

Bit	Description																											
31:24	<p>Port Number (PN) — RO. Indicates the port number for the root port. This value is different for each implemented port:</p> <table border="1"> <thead> <tr> <th>Function</th> <th>Port #</th> <th>Value of PN Field</th> </tr> </thead> <tbody> <tr> <td>D28:F0</td> <td>1</td> <td>01h</td> </tr> <tr> <td>D28:F1</td> <td>2</td> <td>02h</td> </tr> <tr> <td>D28:F2</td> <td>3</td> <td>03h</td> </tr> <tr> <td>D28:F3</td> <td>4</td> <td>04h</td> </tr> <tr> <td>D28:F4</td> <td>5</td> <td>05h</td> </tr> <tr> <td>D28:F5</td> <td>6</td> <td>06h</td> </tr> <tr> <td>D28:F6</td> <td>7</td> <td>07h</td> </tr> <tr> <td>D28:F7</td> <td>8</td> <td>08h</td> </tr> </tbody> </table>	Function	Port #	Value of PN Field	D28:F0	1	01h	D28:F1	2	02h	D28:F2	3	03h	D28:F3	4	04h	D28:F4	5	05h	D28:F5	6	06h	D28:F6	7	07h	D28:F7	8	08h
Function	Port #	Value of PN Field																										
D28:F0	1	01h																										
D28:F1	2	02h																										
D28:F2	3	03h																										
D28:F3	4	04h																										
D28:F4	5	05h																										
D28:F5	6	06h																										
D28:F6	7	07h																										
D28:F7	8	08h																										
23:21	Reserved																											
20	Link Active Reporting Capable (LARC) — RO. Hardwired to 1 to indicate that this port supports the optional capability of reporting the DL_Active state of the Data Link Control and Management State Machine.																											
19:18	Reserved																											
17:15	<p>L1 Exit Latency (EL1) — R/WO.</p> <p>000b = Less than 1us 001b = 1 us to less than 2 us 010b = 2 us to less than 4 us 011b = 4 us to less than 8 us 100b = 8 us to less than 16 us 101b = 16 us to less than 32 us 110b = 32 us to 64 us 111b = more than 64 us</p>																											
14:12	<p>L0s Exit Latency (ELO) — RO. Indicates as exit latency based upon common-clock configuration.</p> <table border="1"> <thead> <tr> <th>LCLT.CCC</th> <th>Value of ELO (these bits)</th> </tr> </thead> <tbody> <tr> <td>0</td> <td>MPC.UCEL (D28:F0/F1/F2/F3:D8h:bits20:18)</td> </tr> <tr> <td>1</td> <td>MPC.CCEL (D28:F0/F1/F2/F3:D8h:bits17:15)</td> </tr> </tbody> </table> <p>NOTE: LCLT.CCC is at D28:F0/F1/F2/F3/F4/F5/F6/F7:50h:bit 6</p>	LCLT.CCC	Value of ELO (these bits)	0	MPC.UCEL (D28:F0/F1/F2/F3:D8h:bits20:18)	1	MPC.CCEL (D28:F0/F1/F2/F3:D8h:bits17:15)																					
LCLT.CCC	Value of ELO (these bits)																											
0	MPC.UCEL (D28:F0/F1/F2/F3:D8h:bits20:18)																											
1	MPC.CCEL (D28:F0/F1/F2/F3:D8h:bits17:15)																											



Bit	Description																																												
11:10	<p>Active State Link PM Support (APMS) — R/WO. Indicates what level of active state link power management is supported on the root port.</p> <table border="1"> <thead> <tr> <th data-bbox="548 386 605 407">Bits</th> <th data-bbox="662 386 781 407">Definition</th> </tr> </thead> <tbody> <tr> <td data-bbox="548 426 589 447">00b</td> <td data-bbox="662 426 1019 447">Neither L0s nor L1 are supported</td> </tr> <tr> <td data-bbox="548 466 589 487">01b</td> <td data-bbox="662 466 883 487">L0s Entry Supported</td> </tr> <tr> <td data-bbox="548 506 589 527">10b</td> <td data-bbox="662 506 873 527">L1 Entry Supported</td> </tr> <tr> <td data-bbox="548 546 589 567">11b</td> <td data-bbox="662 546 1019 567">Both L0s and L1 Entry Supported</td> </tr> </tbody> </table>	Bits	Definition	00b	Neither L0s nor L1 are supported	01b	L0s Entry Supported	10b	L1 Entry Supported	11b	Both L0s and L1 Entry Supported																																		
Bits	Definition																																												
00b	Neither L0s nor L1 are supported																																												
01b	L0s Entry Supported																																												
10b	L1 Entry Supported																																												
11b	Both L0s and L1 Entry Supported																																												
9:4	<p>Maximum Link Width (MLW) — RO. For the root ports, several values can be taken, based upon the value of the chipset config register field RPC.PC1 (Chipset Config Registers:Offset 0224h:bits1:0) for Ports 1-4 and RPC.PC2 (Chipset Config Registers:Offset 0224h:bits1:0) for Ports 5 and 6</p> <table border="1"> <thead> <tr> <th colspan="4" data-bbox="699 730 927 751">Value of MLW Field</th> </tr> <tr> <th data-bbox="526 770 605 791">Port #</th> <th data-bbox="683 770 846 791">RPC.PC1=00b</th> <th colspan="2" data-bbox="927 770 1089 791">RPC.PC1=11b</th> </tr> </thead> <tbody> <tr> <td data-bbox="558 810 573 831">1</td> <td data-bbox="740 810 781 831">01h</td> <td colspan="2" data-bbox="984 810 1024 831">04h</td> </tr> <tr> <td data-bbox="558 850 573 871">2</td> <td data-bbox="740 850 781 871">01h</td> <td colspan="2" data-bbox="984 850 1024 871">01h</td> </tr> <tr> <td data-bbox="558 890 573 911">3</td> <td data-bbox="740 890 781 911">01h</td> <td colspan="2" data-bbox="984 890 1024 911">01h</td> </tr> <tr> <td data-bbox="558 930 573 951">4</td> <td data-bbox="740 930 781 951">01h</td> <td colspan="2" data-bbox="984 930 1024 951">01h</td> </tr> <tr> <th data-bbox="526 970 605 991">Port #</th> <th data-bbox="683 970 846 991">RPC.PC2=00b</th> <th colspan="2" data-bbox="927 970 1089 991">RPC.PC2=11b</th> </tr> <tr> <td data-bbox="558 1010 573 1031">5</td> <td data-bbox="740 1010 781 1031">01h</td> <td colspan="2" data-bbox="984 1010 1024 1031">04h</td> </tr> <tr> <td data-bbox="558 1050 573 1071">6</td> <td data-bbox="740 1050 781 1071">01h</td> <td colspan="2" data-bbox="984 1050 1024 1071">01h</td> </tr> <tr> <td data-bbox="558 1089 573 1110">7</td> <td data-bbox="740 1089 781 1110">01h</td> <td colspan="2" data-bbox="984 1089 1024 1110">01h</td> </tr> <tr> <td data-bbox="558 1129 573 1150">8</td> <td data-bbox="740 1129 781 1150">01h</td> <td colspan="2" data-bbox="984 1129 1024 1150">01h</td> </tr> </tbody> </table>	Value of MLW Field				Port #	RPC.PC1=00b	RPC.PC1=11b		1	01h	04h		2	01h	01h		3	01h	01h		4	01h	01h		Port #	RPC.PC2=00b	RPC.PC2=11b		5	01h	04h		6	01h	01h		7	01h	01h		8	01h	01h	
Value of MLW Field																																													
Port #	RPC.PC1=00b	RPC.PC1=11b																																											
1	01h	04h																																											
2	01h	01h																																											
3	01h	01h																																											
4	01h	01h																																											
Port #	RPC.PC2=00b	RPC.PC2=11b																																											
5	01h	04h																																											
6	01h	01h																																											
7	01h	01h																																											
8	01h	01h																																											
3:0	<p>Maximum Link Speed (MLS) — RO.</p> <p>0001b = indicates the link speed is 2.5 Gb/s 0010b = 5.0 Gb/s and 2.5Gb/s link speeds supported These bits report a value of 0001b if Gen2 disable bit 14 is set in the MPC register, else the value reported is 0010b</p>																																												



19.1.29 LCTL—Link Control Register (PCI Express*—D28:F0/F1/F2/F3/F4/F5/F6/F7)

Address Offset: 50h–51h
Default Value: 0000h

Attribute: R/W, RO
Size: 16 bits

Bit	Description
15:10	Reserved
9	Hardware Autonomous Width Disable – RO. Hardware never attempts to change the link width except when attempting to correct unreliable Link operation.
8	Reserved
7	Extended Synch (ES) – R/W. 0 = Extended synch disabled. 1 = Forces extended transmission of FTS ordered sets in FTS and extra TS2 at exit from L1 prior to entering L0.
6	Common Clock Configuration (CCC) – R/W. 0 = The PCH and device are not using a common reference clock. 1 = The PCH and device are operating with a distributed common reference clock.
5	Retrain Link (RL) – R/W. 0 = This bit always returns 0 when read. 1 = The root port will train its downstream link. NOTE: Software uses LSTS.LT (D28:F0/F1/F2/F3/F4/F5/F6/F7:52, bit 11) to check the status of training. NOTE: It is permitted to write 1b to this bit while simultaneously writing modified values to other fields in this register. If the LTSSM is not already in Recovery or Configuration, the resulting Link training must use the modified values. If the LTSSM is already in Recovery or Configuration, the modified values are not required to affect the Link training that is already in progress.
4	Link Disable (LD) – R/W. 0 = Link enabled. 1 = The root port will disable the link.
3	Read Completion Boundary Control (RCBC) – RO. Indicates the read completion boundary is 64 bytes.
2	Reserved
1:0	Active State Link PM Control (APMC) – R/W. Indicates whether the root port should enter L0s or L1 or both. 00 = Disabled 01 = L0s Entry Enabled 10 = L1 Entry Enabled 11 = L0s and L1 Entry Enabled



19.1.31 SLCAP—Slot Capabilities Register (PCI Express*—D28:F0/F1/F2/F3/F4/F5/F6/F7)

Address Offset: 54h-57h
Default Value: 00040060h

Attribute: R/WO, RO
Size: 32 bits

Bit	Description
31:19	Physical Slot Number (PSN) — R/WO. This is a value that is unique to the slot number. BIOS sets this field and it remains set until a platform reset.
18:17	Reserved
16:15	Slot Power Limit Scale (SLS) — R/WO. Specifies the scale used for the slot power limit value. BIOS sets this field and it remains set until a platform reset.
14:7	Slot Power Limit Value (SLV) — R/WO. Specifies the upper limit (in conjunction with SLS value), on the upper limit on power supplied by the slot. The two values together indicate the amount of power in watts allowed for the slot. BIOS sets this field and it remains set until a platform reset.
6	Hot Plug Capable (HPC) — R/WO. 1b = Indicates that Hot-Plug is supported.
5	Hot Plug Surprise (HPS) — R/WO. 1b = Indicates the device may be removed from the slot without prior notification.
4	Power Indicator Present (PIP) — RO. 0b = Indicates that a power indicator LED is not present for this slot.
3	Attention Indicator Present (AIP) — RO. 0b = Indicates that an attention indicator LED is not present for this slot.
2	MRL Sensor Present (MSP) — RO. 0b = Indicates that an MRL sensor is not present.
1	Power Controller Present (PCP) — RO. 0b = Indicates that a power controller is not implemented for this slot.
0	Attention Button Present (ABP) — RO. 0b = Indicates that an attention button is not implemented for this slot.



19.1.33 SLSTS—Slot Status Register (PCI Express*—D28:F0/F1/F2/F3/F4/F5/F6/F7)

Address Offset: 5Ah-5Bh
Default Value: 0000h

Attribute: R/WC, RO
Size: 16 bits

Bit	Description
15:9	Reserved
8	Link Active State Changed (LASC) — R/WC. 1 = This bit is set when the value reported in Data Link Layer Link Active field of the Link Status register (D28:F0/F1/F2/F3/F4/F5/F6/F7:52h:bit 13) is changed. In response to a Data Link Layer State Changed event, software must read Data Link Layer Link Active field of the Link Status register to determine if the link is active before initiating configuration cycles to the hot plugged device.
7	Reserved
6	Presence Detect State (PDS) — RO. If XCAP.SI (D28:F0/F1/F2/F3/F4/F5/F6/F7:42h:bit 8) is set (indicating that this root port spawns a slot), then this bit: 0 = Indicates the slot is empty. 1 = Indicates the slot has a device connected. Otherwise, if XCAP.SI is cleared, this bit is always set (1).
5	MRL Sensor State (MS) — Reserved as the MRL sensor is not implemented.
4	Reserved
3	Presence Detect Changed (PDC) — R/WC. 0 = No change in the PDS bit. 1 = The PDS bit changed states.
2	MRL Sensor Changed (MSC) — Reserved as the MRL sensor is not implemented.
1	Power Fault Detected (PFD) — Reserved as a power controller is not implemented.
0	Reserved



19.1.36 DCAP2—Device Capabilities 2 Register (PCI Express*—D28:F0/F1/F2/F3/F4/F5/F6/F7)

Address Offset: 64h–67h Attribute: RO
Default Value: 00000016h Size: 32 bits

Bit	Description
31:5	Reserved
4	Completion Timeout Disable Supported (CTDS) — RO. A value of 1b indicates support for the Completion Timeout Disable mechanism.
3:0	Completion Timeout Ranges Supported (CTRS) — RO. This field indicates device support for the optional Completion Timeout programmability mechanism. This mechanism allows system software to modify the Completion Timeout value. This field is hardwired to support 10 ms to 250 ms and 250 ms to 4 s.

19.1.37 DCTL2—Device Control 2 Register (PCI Express*—D28:F0/F1/F2/F3/F4/F5/F6/F7)

Address Offset: 68h–69h Attribute: RO, R/W
Default Value: 0000h Size: 16 bits

Bit	Description
15:5	Reserved
4	Completion Timeout Disable (CTD) — R/W. When set to 1b, this bit disables the Completion Timeout mechanism. If there are outstanding requests when the bit is cleared, it is permitted but not required for hardware to apply the completion timeout mechanism to the outstanding requests. If this is done, it is permitted to base the start time for each request on either the time this bit was cleared or the time each request was issued.
3:0	Completion Timeout Value (CTV) — R/W. This field allows system software to modify the Completion Timeout value. 0000b = Default range: 40–50 ms (specification range 50 us to 50 ms) 0101b = 40–50 ms (specification range is 16 ms to 55 ms) 0110b = 160–170 ms (specification range is 65 ms to 210 ms) 1001b = 400–500 ms (specification range is 260 ms to 900 ms) 1010b = 1.6–1.7 s (specification range is 1 s to 3.5 s) All other values are Reserved. NOTE: Software is permitted to change the value in this field at any time. For requests already pending when the Completion Timeout Value is changed, hardware is permitted to use either the new or the old value for the outstanding requests, and is permitted to base the start time for each request either on when this value was changed or on when each request was issued.



19.1.39 LSTS2—Link Status 2 Register (PCI Express*—D28:F0/F1/F2/F3/F4/F5/F6/F7)

Address Offset: 72h–73h Attribute: RO
Default Value: 0000h Size: 16 bits

Bit	Description
15:1	Reserved
0	<p>Current De-emphasis Level (CDL) — RO. When the Link is operating at 5 GT/s speed, this bit reflects the level of de-emphasis.</p> <p>Encodings: 0 = 6 dB 1 = 3.5 dB</p> <p>The value in this bit is undefined when the Link is operating at 2.5 GT/s speed.</p>

19.1.40 MID—Message Signaled Interrupt Identifiers Register (PCI Express*—D28:F0/F1/F2/F3/F4/F5/F6/F7)

Address Offset: 80h–81h Attribute: RO
Default Value: 9005h Size: 16 bits

Bit	Description
15:8	Next Pointer (NEXT) — RO. Indicates the location of the next pointer in the list.
7:0	Capability ID (CID) — RO. Capabilities ID indicates MSI.

19.1.41 MC—Message Signaled Interrupt Message Control Register (PCI Express*—D28:F0/F1/F2/F3/F4/F5/F6/F7)

Address Offset: 82–83h Attribute: R/W, RO
Default Value: 0000h Size: 16 bits

Bit	Description
15:8	Reserved
7	64 Bit Address Capable (C64) — RO. Capable of generating a 32-bit message only.
6:4	Multiple Message Enable (MME) — R/W. These bits are R/W for software compatibility, but only one message is ever sent by the root port.
3:1	Multiple Message Capable (MMC) — RO. Only one message is required.
0	<p>MSI Enable (MSIE) — R/W. 0 = MSI is disabled. 1 = MSI is enabled and traditional interrupt pins are not used to generate interrupts.</p> <p>NOTE: CMD.BME (D28:F0/F1/F2/F3/F4/F5/F6/F7:04h:bit 2) must be set for an MSI to be generated. If CMD.BME is cleared, and this bit is set, no interrupts (not even pin based) are generated.</p>



19.1.42 MA—Message Signaled Interrupt Message Address Register (PCI Express*—D28:F0/F1/F2/F3/F4/F5/F6/F7)

Address Offset: 84h–87h Attribute: R/W
 Default Value: 00000000h Size: 32 bits

Bit	Description
31:2	Address (ADDR) — R/W. Lower 32 bits of the system specified message address, always DW aligned.
1:0	Reserved

19.1.43 MD—Message Signaled Interrupt Message Data Register (PCI Express*—D28:F0/F1/F2/F3/F4/F5/F6/F7)

Address Offset: 88h–89h Attribute: R/W
 Default Value: 0000h Size: 16 bits

Bit	Description
15:0	Data (DATA) — R/W. This 16-bit field is programmed by system software if MSI is enabled. Its content is driven onto the lower word (PCI AD[15:0]) during the data phase of the MSI memory write transaction.

19.1.44 SVCAP—Subsystem Vendor Capability Register (PCI Express*—D28:F0/F1/F2/F3/F4/F5/F6/F7)

Address Offset: 90h–91h Attribute: RO
 Default Value: A00Dh Size: 16 bits

Bit	Description
15:8	Next Capability (NEXT) — RO. Indicates the location of the next pointer in the list.
7:0	Capability Identifier (CID) — RO. Value of 0Dh indicates this is a PCI bridge subsystem vendor capability.

19.1.45 SVID—Subsystem Vendor Identification Register (PCI Express*—D28:F0/F1/F2/F3/F4/F5/F6/F7)

Address Offset: 94h–97h Attribute: R/WO
 Default Value: 00000000h Size: 32 bits

Bit	Description
31:16	Subsystem Identifier (SID) — R/WO. Indicates the subsystem as identified by the vendor. This field is write once and is locked down until a bridge reset occurs (not the PCI bus reset).
15:0	Subsystem Vendor Identifier (SVID) — R/WO. Indicates the manufacturer of the subsystem. This field is write once and is locked down until a bridge reset occurs (not the PCI bus reset).



19.1.46 PMCAP—Power Management Capability Register (PCI Express*—D28:F0/F1/F2/F3/F4/F5/F6/F7)

Address Offset: A0h–A1h Attribute: RO
Default Value: 0001h Size: 16 bits

Bit	Description
15:8	Next Capability (NEXT) — RO. Indicates this is the last item in the list.
7:0	Capability Identifier (CID) — RO. Value of 01h indicates this is a PCI power management capability.

19.1.47 PMC—PCI Power Management Capabilities Register (PCI Express*—D28:F0/F1/F2/F3/F4/F5/F6/F7)

Address Offset: A2h–A3h Attribute: RO
Default Value: C802h Size: 16 bits

Bit	Description
15:11	PME_Support (PMES) — RO. Indicates PME# is supported for states D0, D3 _{HOT} and D3 _{COLD} . The root port does not generate PME#, but reporting that it does is necessary for some legacy operating systems to enable PME# in devices connected behind this root port.
10	D2_Support (D2S) — RO. The D2 state is not supported.
9	D1_Support (D1S) — RO. The D1 state is not supported.
8:6	Aux_Current (AC) — RO. Reports 375 mA maximum suspend well current required when in the D3 _{COLD} state.
5	Device Specific Initialization (DSI) — RO. 1 = Indicates that no device-specific initialization is required.
4	Reserved
3	PME_Clock (PMEC) — RO. 1 = Indicates that PCI clock is not required to generate PME#.
2:0	Version (VS) — RO. Indicates support for <i>Revision 1.1 of the PCI Power Management Specification</i> .



19.1.48 PMCS—PCI Power Management Control and Status Register (PCI Express*—D28:F0/F1/F2/F3/F4/F5/F6/F7)

Address Offset: A4h–A7h Attribute: R/W, RO
 Default Value: 00000000h Size: 32 bits

Bit	Description
31:24	Reserved
23	Bus Power / Clock Control Enable (BPCE) — Reserved per <i>PCI Express* Base Specification, Revision 1.0a</i> .
22	B2/B3 Support (B23S) — Reserved per <i>PCI Express* Base Specification, Revision 1.0a</i> .
21:16	Reserved
15	PME Status (PMES) — RO. 1 = Indicates a PME was received on the downstream link.
14:9	Reserved
8	PME Enable (PMEE) — R/W. 1 = Indicates PME is enabled. The root port takes no action on this bit, but it must be R/W for some legacy operating systems to enable PME# on devices connected to this root port. This bit is sticky and resides in the resume well. The reset for this bit is RSMRST# which is not asserted during a warm reset.
7:2	Reserved
1:0	Power State (PS) — R/W. This field is used both to determine the current power state of the root port and to set a new power state. The values are: 00 = D0 state 11 = D3 _{HOT} state NOTE: When in the D3 _{HOT} state, the controller's configuration space is available, but the I/O and memory spaces are not. Type 1 configuration cycles are also not accepted. Interrupts are not required to be blocked as software will disable interrupts prior to placing the port into D3 _{HOT} . If software attempts to write a '10' or '01' to these bits, the write will be ignored.



19.1.49 MPC2—Miscellaneous Port Configuration Register 2 (PCI Express*—D28:F0/F1/F2/F3/F4/F5/F6/F7)

Address Offset: D4h–D7h
Default Value: 00000000h

Attribute: R/W, RO
Size: 32 bits

Bit	Description
31:5	Reserved
4	ASPM Control Override Enable (ASPMCOEN) — R/W. 1 = Root port will use the values in the ASPM Control Override registers 0 = Root port will use the ASPM Registers in the Link Control register. NOTES: This register allows BIOS to control the root port ASPM settings instead of the OS.
3:2	ASPM Control Override (ASPMO) — R/W. Provides BIOS control of whether root port should enter L0s or L1 or both. 00 = Disabled 01 = L0s Entry Enabled 10 = L1 Entry Enabled 11 = L0s and L1 Entry Enabled.
1	EOI Forwarding Disable (EOIFD) — R/W. When set, EOI messages are not claimed on the backbone by this port and will not be forwarded across the PCIe link. 0 = Broadcast EOI messages that are sent on the backbone are claimed by this port and forwarded across the PCIe link. 1 = Broadcast EOI messages are not claimed on the backbone by this port and will not be forwarded across the PCIe Link.
0	L1 Completion Timeout Mode (LICTM) — R/W. 0 = PCI Express Specification Compliant. Completion timeout is disabled during software initiated L1, and enabled during ASPM initiate L1. 1 = Completion timeout is enabled during L1, regardless of how L1 entry was initiated.



Bit	Description																		
21	Flow Control During L1 Entry (FCDL1E) — R/W. 0 = No flow control update DLLPs sent during L1 Ack transmission. 1 = Flow control update DLLPs sent during L1 Ack transmission as required to meet the 30 μs periodic flow control update.																		
20:18	Unique Clock Exit Latency (UCEL) — R/W. This value represents the L0s Exit Latency for unique-clock configurations (LCTL.CCC = 0) (D28:F0/F1/F2/F3/F4/F5/F6/F7:Offset 50h:bit 6). It defaults to 512 ns to less than 1 μs, but may be overridden by BIOS.																		
17:15	Common Clock Exit Latency (CCEL) — R/W. This value represents the L0s Exit Latency for common-clock configurations (LCTL.CCC = 1) (D28:F0/F1/F2/F3/F4/F5/F6/F7:Offset 50h:bit 6). It defaults to 128 ns to less than 256 ns, but may be overridden by BIOS.																		
14	PCIe Gen2 Speed Disable 0 = PCIe supported data rate is defined as set through Supported Link Speed and Target Link Speed settings. 1 = PCIe supported data rate is limited to 2.5 GT/s (Gen1). Supported Link Speed register bits will reflect "0001b" when this bit is set. When this bit is changed, link retrain needs to be performed for the change to be effective.																		
13:8	Reserved																		
7	Port I/OxApic Enable (PAE) — R/W. 0 = Hole is disabled. 1 = A range is opened through the bridge for the following memory addresses: <table border="1" style="margin-left: 40px;"> <thead> <tr> <th>Port #</th> <th>Address</th> </tr> </thead> <tbody> <tr> <td>1</td> <td>FEC1_0000h – FEC1_7FFFh</td> </tr> <tr> <td>2</td> <td>FEC1_8000h – FEC1_FFFFh</td> </tr> <tr> <td>3</td> <td>FEC2_0000h – FEC2_7FFFh</td> </tr> <tr> <td>4</td> <td>FEC2_8000h – FEC2_FFFFh</td> </tr> <tr> <td>5</td> <td>FEC3_0000h – FEC3_7FFFh</td> </tr> <tr> <td>6</td> <td>FEC3_8000h – FEC3_FFFFh</td> </tr> <tr> <td>7</td> <td>FEC4_0000h – FEC4_7FFFh</td> </tr> <tr> <td>8</td> <td>FEC4_8000h – FEC4_FFFFh</td> </tr> </tbody> </table>	Port #	Address	1	FEC1_0000h – FEC1_7FFFh	2	FEC1_8000h – FEC1_FFFFh	3	FEC2_0000h – FEC2_7FFFh	4	FEC2_8000h – FEC2_FFFFh	5	FEC3_0000h – FEC3_7FFFh	6	FEC3_8000h – FEC3_FFFFh	7	FEC4_0000h – FEC4_7FFFh	8	FEC4_8000h – FEC4_FFFFh
Port #	Address																		
1	FEC1_0000h – FEC1_7FFFh																		
2	FEC1_8000h – FEC1_FFFFh																		
3	FEC2_0000h – FEC2_7FFFh																		
4	FEC2_8000h – FEC2_FFFFh																		
5	FEC3_0000h – FEC3_7FFFh																		
6	FEC3_8000h – FEC3_FFFFh																		
7	FEC4_0000h – FEC4_7FFFh																		
8	FEC4_8000h – FEC4_FFFFh																		
6:3	Reserved																		
2	Bridge Type (BT) — R/WO. This register can be used to modify the Base Class and Header Type fields from the default PCI-to-PCI bridge to a Host Bridge. Having the root port appear as a Host Bridge is useful in some server configurations. 0 = The root port bridge type is a PCI-to-PCI Bridge, Header Sub-Class = 04h, and Header Type = Type 1. 1 = The root port bridge type is a PCI-to-PCI Bridge, Header Sub-Class = 00h, and Header Type = Type 0.																		
1	Hot Plug SMI Enable (HPME) — R/W. 0 = SMI generation based on a Hot-Plug event is disabled. 1 = Enables the root port to generate SMI whenever a Hot-Plug event is detected.																		
0	Power Management SMI Enable (PMME) — R/W. 0 = SMI generation based on a power management event is disabled. 1 = Enables the root port to generate SMI whenever a power management event is detected.																		



19.1.55 UES—Uncorrectable Error Status Register (PCI Express*—D28:F0/F1/F2/F3/F4/F5/F6/F7)

Address Offset: 104h-107h Attribute: R/WC, RO
Default Value: 0000000000x0xxx0x0x0000000x0000b Size: 32 bits

This register maintains its state through a platform reset. It loses its state upon suspend.

Bit	Description
31:21	Reserved
20	Unsupported Request Error Status (URE) — R/WC. Indicates an unsupported request was received.
19	ECRC Error Status (EE) — RO. ECRC is not supported.
18	Malformed TLP Status (MT) — R/WC. Indicates a malformed TLP was received.
17	Receiver Overflow Status (RO) — R/WC. Indicates a receiver overflow occurred.
16	Unexpected Completion Status (UC) — R/WC. Indicates an unexpected completion was received.
15	Completion Abort Status (CA) — R/WC. Indicates a completer abort was received.
14	Completion Timeout Status (CT) — R/WC. Indicates a completion timed out. This bit is set if Completion Timeout is enabled and a completion is not returned within the time specified by the Completion TImeout Value
13	Flow Control Protocol Error Status (FCPE) — RO. Flow Control Protocol Errors not supported.
12	Poisoned TLP Status (PT) — R/WC. Indicates a poisoned TLP was received.
11:5	Reserved
4	Data Link Protocol Error Status (DLPE) — R/WC. Indicates a data link protocol error occurred.
3:1	Reserved
0	Training Error Status (TE) — RO. Training Errors not supported.



19.1.56 UEM—Uncorrectable Error Mask Register (PCI Express*—D28:F0/F1/F2/F3/F4/F5/F6/F7)

Address Offset: 108h–10Bh Attribute: R/WO, RO
 Default Value: 00000000h Size: 32 bits

When set, the corresponding error in the UES register is masked, and the logged error will cause no action. When cleared, the corresponding error is enabled.

Bit	Description
31:21	Reserved
20	Unsupported Request Error Mask (URE) — R/WO. 0 = The corresponding error in the UES register (D28:F0/F1/F2/F3/F4/F5/F6/F7:144) is enabled. 1 = The corresponding error in the UES register (D28:F0/F1/F2/F3/F4/F5/F6/F7:144) is masked.
19	ECRC Error Mask (EE) — RO. ECRC is not supported.
18	Malformed TLP Mask (MT) — R/WO. 0 = The corresponding error in the UES register (D28:F0/F1/F2/F3/F4/F5/F6/F7:144) is enabled. 1 = The corresponding error in the UES register (D28:F0/F1/F2/F3/F4/F5/F6/F7:144) is masked.
17	Receiver Overflow Mask (RO) — R/WO. 0 = The corresponding error in the UES register (D28:F0/F1/F2/F3/F4/F5/F6/F7:144) is enabled. 1 = The corresponding error in the UES register (D28:F0/F1/F2/F3/F4/F5/F6/F7:144) is masked.
16	Unexpected Completion Mask (UC) — R/WO. 0 = The corresponding error in the UES register (D28:F0/F1/F2/F3/F4/F5/F6/F7:144) is enabled. 1 = The corresponding error in the UES register (D28:F0/F1/F2/F3/F4/F5/F6/F7:144) is masked.
15	Completion Abort Mask (CA) — R/WO. 0 = The corresponding error in the UES register (D28:F0/F1/F2/F3/F4/F5/F6/F7:144) is enabled. 1 = The corresponding error in the UES register (D28:F0/F1/F2/F3/F4/F5/F6/F7:144) is masked.
14	Completion Timeout Mask (CT) — R/WO. 0 = The corresponding error in the UES register (D28:F0/F1/F2/F3/F4/F5/F6/F7:144) is enabled. 1 = The corresponding error in the UES register (D28:F0/F1/F2/F3/F4/F5/F6/F7:144) is masked.
13	Flow Control Protocol Error Mask (FCPE) — RO. Flow Control Protocol Errors not supported.
12	Poisoned TLP Mask (PT) — R/WO. 0 = The corresponding error in the UES register (D28:F0/F1/F2/F3/F4/F5/F6/F7:144) is enabled. 1 = The corresponding error in the UES register (D28:F0/F1/F2/F3/F4/F5/F6/F7:144) is masked.
11:5	Reserved



Bit	Description
4	Data Link Protocol Error Mask (DLPE) — R/WO. 0 = The corresponding error in the UES register (D28:F0/F1/F2/F3/F4/F5/F6/F7:144) is enabled. 1 = The corresponding error in the UES register (D28:F0/F1/F2/F3/F4/F5/F6/F7:144) is masked.
3:1	Reserved
0	Training Error Mask (TE) — RO. Training Errors not supported

19.1.57 UEV — Uncorrectable Error Severity Register (PCI Express*—D28:F0/F1/F2/F3/F4/F5/F6/F7)

Address Offset: 10Ch-10Fh
Default Value: 00060011h

Attribute: RO, R/W
Size: 32 bits

Bit	Description
31:21	Reserved
20	Unsupported Request Error Severity (URE) — R/W. 0 = Error considered non-fatal. (Default) 1 = Error is fatal.
19	ECRC Error Severity (EE) — RO. ECRC is not supported.
18	Malformed TLP Severity (MT) — R/W. 0 = Error considered non-fatal. 1 = Error is fatal. (Default)
17	Receiver Overflow Severity (RO) — R/W. 0 = Error considered non-fatal. 1 = Error is fatal. (Default)
16	Reserved
15	Completion Abort Severity (CA) — R/W. 0 = Error considered non-fatal. (Default) 1 = Error is fatal.
14	Reserved
13	Flow Control Protocol Error Severity (FCPE) — RO. Flow Control Protocol Errors not supported.
12	Poisoned TLP Severity (PT) — R/W. 0 = Error considered non-fatal. (Default) 1 = Error is fatal.
11:5	Reserved
4	Data Link Protocol Error Severity (DLPE) — R/W. 0 = Error considered non-fatal. 1 = Error is fatal. (Default)
3:1	Reserved
0	Training Error Severity (TE) — R/W. TE is not supported.



19.1.58 CES – Correctable Error Status Register (PCI Express*—D28:F0/F1/F2/F3/F4/F5/F6/F7)

Address Offset: 110h–113h Attribute: R/WC
 Default Value: 00000000h Size: 32 bits

Bit	Description
31:14	Reserved
13	Advisory Non-Fatal Error Status (ANFES) – R/WC. 0 = Advisory Non-Fatal Error did not occur. 1 = Advisory Non-Fatal Error did occur.
12	Replay Timer Timeout Status (RTT) – R/WC. Indicates the replay timer timed out.
11:9	Reserved
8	Replay Number Rollover Status (RNR) – R/WC. Indicates the replay number rolled over.
7	Bad DLLP Status (BD) – R/WC. Indicates a bad DLLP was received.
6	Bad TLP Status (BT) – R/WC. Indicates a bad TLP was received.
5:1	Reserved
0	Receiver Error Status (RE) – R/WC. Indicates a receiver error occurred.

19.1.59 CEM – Correctable Error Mask Register (PCI Express*—D28:F0/F1/F2/F3/F4/F5/F6/F7)

Address Offset: 114h–117h Attribute: R/WO
 Default Value: 00002000h Size: 32 bits

When set, the corresponding error in the CES register is masked, and the logged error will cause no action. When cleared, the corresponding error is enabled.

Bit	Description
31:14	Reserved
13	Advisory Non-Fatal Error Mask (ANFEM) – R/WO. 0 = Does not mask Advisory Non-Fatal errors. 1 = Masks Advisory Non-Fatal errors from (a) signaling ERR_COR to the device control register and (b) updating the Uncorrectable Error Status register. This register is set by default to enable compatibility with software that does not comprehend Role-Based Error Reporting. NOTE: The correctable error detected bit in device status register is set whenever the Advisory Non-Fatal error is detected, independent of this mask bit.
12	Replay Timer Timeout Mask (RTT) – R/WO. Mask for replay timer timeout.
11:9	Reserved
8	Replay Number Rollover Mask (RNR) – R/WO. Mask for replay number rollover.
7	Bad DLLP Mask (BD) – R/WO. Mask for bad DLLP reception.
6	Bad TLP Mask (BT) – R/WO. Mask for bad TLP reception.
5:1	Reserved
0	Receiver Error Mask (RE) – R/WO. Mask for receiver errors.



19.1.60 AECC — Advanced Error Capabilities and Control Register (PCI Express*—D28:F0/F1/F2/F3/F4/F5/F6/F7)

Address Offset: 118h-11Bh Attribute: RO
 Default Value: 00000000h Size: 32 bits

Bit	Description
31:9	Reserved
8	ECRC Check Enable (ECE) — RO. ECRC is not supported.
7	ECRC Check Capable (ECC) — RO. ECRC is not supported.
6	ECRC Generation Enable (EGE) — RO. ECRC is not supported.
5	ECRC Generation Capable (EGC) — RO. ECRC is not supported.
4:0	First Error Pointer (FEP) — RO. Identifies the bit position of the last error reported in the Uncorrectable Error Status Register.

19.1.61 RES — Root Error Status Register (PCI Express*—D28:F0/F1/F2/F3/F4/F5/F6/F7)

Address Offset: 130h-133h Attribute: R/WC, RO
 Default Value: 00000000h Size: 32 bits

Bit	Description
31:27	Advanced Error Interrupt Message Number (AEMN) — RO. There is only one error interrupt allocated.
26:7	Reserved
6	Fatal Error Messages Received (FEMR) — RO. Set when one or more Fatal Uncorrectable Error Messages have been received.
5	Non-Fatal Error Messages Received (NFEMR) — RO. Set when one or more Non-Fatal Uncorrectable error messages have been received
4	First Uncorrectable Fatal (FUF) — RO. Set when the first Uncorrectable Error message received is for a fatal error.
3	Multiple ERR_FATAL/NONFATAL Received (MENR) — RO. For the PCH, only one error will be captured.
2	ERR_FATAL/NONFATAL Received (ENR) — R/WC. 0 = No error message received. 1 = Either a fatal or a non-fatal error message is received.
1	Multiple ERR_COR Received (MCR) — RO. For the PCH, only one error will be captured.
0	ERR_COR Received (CR) — R/WC. 0 = No error message received. 1 = A correctable error message is received.

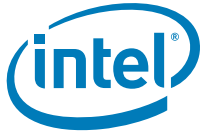



20 High Precision Event Timer Registers

The timer registers are memory-mapped in a non-indexed scheme. This allows the processor to directly access each register without having to use an index register. The timer register space is 1024 bytes. The registers are generally aligned on 64-bit boundaries to simplify implementation with IA64 processors. There are four possible memory address ranges beginning at 1) FED0_0000h, 2) FED0_1000h, 3) FED0_2000h, 4) FED0_3000h. The choice of address range will be selected by configuration bits in the High Precision Timer Configuration Register (Chipset Config Registers:Offset 3404h).

Behavioral Rules:

1. Software must not attempt to read or write across register boundaries. For example, a 32-bit access should be to offset x0h, x4h, x8h, or xCh. 32-bit accesses should not be to 01h, 02h, 03h, 05h, 06h, 07h, 09h, 0Ah, 0Bh, 0Dh, 0Eh, or 0Fh. Any accesses to these offsets will result in an unexpected behavior, and may result in a master abort. However, these accesses should not result in system hangs. 64-bit accesses can only be to x0h and must not cross 64-bit boundaries.
2. Software should not write to Read Only registers.
3. Software should not expect any particular or consistent value when reading reserved registers or bits.

20.1 Memory Mapped Registers

Table 20-1. Memory-Mapped Register Address Map (Sheet 1 of 2)

Offset	Mnemonic	Register	Default	Attribute
000h-007h	GCAP_ID	General Capabilities and Identification	0429B17F80 86A201h	RO
008h-00Fh	—	Reserved	—	—
010h-017h	GEN_CONF	General Configuration	0000000000 000000h	R/W
018h-01Fh	—	Reserved	—	—
020h-027h	GINTR_STA	General Interrupt Status	0000000000 000000h	R/WC
028h-0EFh	—	Reserved	—	—
0F0h-0F7h	MAIN_CNT	Main Counter Value	N/A	R/W
0F8h-0FFh	—	Reserved	—	—
100h-107h	TIM0_CONF	Timer 0 Configuration and Capabilities	N/A	R/W, RO
108h-10Fh	TIM0_COMP	Timer 0 Comparator Value	N/A	R/W
110h-11Fh	—	Reserved	—	—
120h-127h	TIM1_CONF	Timer 1 Configuration and Capabilities	N/A	R/W, RO



Table 20-1. Memory-Mapped Register Address Map (Sheet 2 of 2)

Offset	Mnemonic	Register	Default	Attribute
128h-12Fh	TIM1_COMP	Timer 1 Comparator Value	N/A	R/W
130h-13Fh	—	Reserved	—	—
140h-147h	TIM2_CONF	Timer 2 Configuration and Capabilities	N/A	R/W, RO
148h-14Fh	TIM2_COMP	Timer 2 Comparator Value	N/A	R/W
150h-15Fh	—	Reserved	—	—
160h-167h	TIM3_CONG	Timer 3 Configuration and Capabilities	N/A	R/W, RO
168h-16Fh	TIM3_COMP	Timer 3 Comparator Value	N/A	R/W
180h-187h	TIM4_CONG	Timer 4 Configuration and Capabilities	N/A	R/W, RO
188h-18Fh	TIM4_COMP	Timer 4 Comparator Value	N/A	R/W
190h-19Fh	—	Reserved	—	—
1A0h-1A7h	TIM5_CONG	Timer 5 Configuration and Capabilities	N/A	R/W, RO
1A8h-1AFh	TIM5_COMP	Timer 5 Comparator Value	N/A	R/W
1B0h-1BFh	—	Reserved	—	—
1C0h-1C7h	TIM6_CONG	Timer 6 Configuration and Capabilities	N/A	R/W, RO
1C8h-1CFh	TIM6_COMP	Timer 6 Comparator Value	N/A	R/W
1D0h-1DFh	—	Reserved	—	—
1E0h-1E7h	TIM7_CONG	Timer 7 Configuration and Capabilities	N/A	R/W, RO
1E8h-1EFh	TIM7_COMP	Timer 7 Comparator Value	N/A	R/W
1F0h-19Fh	—	Reserved	—	—
200h-3FFh	—	Reserved	—	—

NOTES:

1. Reads to reserved registers or bits will return a value of 0.
2. Software must not attempt locks to the memory-mapped I/O ranges for High Precision Event Timers. If attempted, the lock is not honored, which means potential deadlock conditions may occur.



20.1.1 GCAP_ID—General Capabilities and Identification Register

Address Offset: 00h Attribute: RO
 Default Value: 0429B17F8086A201h Size: 64 bits

Bit D	Description
63:32	Main Counter Tick Period (COUNTER_CLK_PER_CAP) — RO. This field indicates the period at which the counter increments in femptoseconds (10^{-15} seconds). This will return 0429B17Fh when read. This indicates a period of 69841279 fs (69.841279 ns).
31:16	Vendor ID Capability (VENDOR_ID_CAP) — RO. This is a 16-bit value assigned to Intel.
15	Legacy Replacement Rout Capable (LEG_RT_CAP) — RO. Hardwired to 1. Legacy Replacement Interrupt Rout option is supported.
14	Reserved. This bit returns 0 when read.
13	Counter Size Capability (COUNT_SIZE_CAP) — RO. Hardwired to 1. Counter is 64-bit wide.
12:8	Number of Timer Capability (NUM_TIM_CAP) — RO. This field indicates the number of timers in this block. 07h = Eight timers.
7:0	Revision Identification (REV_ID) — RO. This indicates which revision of the function is implemented. Default value will be 01h.

20.1.2 GEN_CONF—General Configuration Register

Address Offset: 010h Attribute: R/W
 Default Value: 00000000 00000000h Size: 64 bits

Bit	Description
63:2	Reserved. These bits return 0 when read.
1	<p>Legacy Replacement Rout (LEG_RT_CNF) — R/W. If the ENABLE_CNF bit and the LEG_RT_CNF bit are both set, then the interrupts will be routed as follows:</p> <ul style="list-style-type: none"> • Timer 0 is routed to IRQ0 in 8259 or IRQ2 in the I/O APIC • Timer 1 is routed to IRQ8 in 8259 or IRQ8 in the I/O APIC • Timer 2-n is routed as per the routing in the timer n config registers. • If the Legacy Replacement Rout bit is set, the individual routing bits for Timers 0 and 1 (APIC) will have no impact. • If the Legacy Replacement Rout bit is not set, the individual routing bits for each of the timers are used. • This bit will default to 0. BIOS can set it to 1 to enable the legacy replacement routing, or 0 to disable the legacy replacement routing.
0	<p>Overall Enable (ENABLE_CNF) — R/W. This bit must be set to enable any of the timers to generate interrupts. If this bit is 0, then the main counter will halt (will not increment) and no interrupts will be caused by any of these timers. For level-triggered interrupts, if an interrupt is pending when the ENABLE_CNF bit is changed from 1 to 0, the interrupt status indications (in the various Txx_INT_STS bits) will not be cleared. Software must write to the Txx_INT_STS bits to clear the interrupts.</p> <p>NOTE: This bit will default to 0. BIOS can set it to 1 or 0.</p>



20.1.3 GINTR_STA—General Interrupt Status Register

Address Offset: 020h Attribute: R/WC
Default Value: 00000000 00000000h Size: 64 bits

Bit De	scription
63:8	Reserved. These bits will return 0 when read.
7	Timer 7 Interrupt Active (T07_INT_STS) — R/WC. Same functionality as Timer 0.
6	Timer 6 Interrupt Active (T06_INT_STS) — R/WC. Same functionality as Timer 0.
5	Timer 5 Interrupt Active (T05_INT_STS) — R/WC. Same functionality as Timer 0.
4	Timer 4 Interrupt Active (T04_INT_STS) — R/WC. Same functionality as Timer 0.
3	Timer 3 Interrupt Active (T03_INT_STS) — R/WC. Same functionality as Timer 0.
2	Timer 2 Interrupt Active (T02_INT_STS) — R/WC. Same functionality as Timer 0.
1	Timer 1 Interrupt Active (T01_INT_STS) — R/WC. Same functionality as Timer 0.
0	Timer 0 Interrupt Active (T00_INT_STS) — R/WC. The functionality of this bit depends on whether the edge or level-triggered mode is used for this timer. (default = 0) If set to level-triggered mode: This bit will be set by hardware if the corresponding timer interrupt is active. Once the bit is set, it can be cleared by software writing a 1 to the same bit position. Writes of 0 to this bit will have no effect. If set to edge-triggered mode: This bit should be ignored by software. Software should always write 0 to this bit. NOTE: Defaults to 0. In edge triggered mode, this bit will always read as 0 and writes will have no effect.

20.1.4 MAIN_CNT—Main Counter Value Register

Address Offset: 0F0h Attribute: R/W
Default Value: N/A Size: 64 bits

Bit De	scription
63:0	Counter Value (COUNTER_VAL[63:0]) — R/W. Reads return the current value of the counter. Writes load the new value to the counter. NOTES: <ol style="list-style-type: none">Writes to this register should only be done while the counter is halted.Reads to this register return the current value of the main counter.32-bit counters will always return 0 for the upper 32-bits of this register.If 32-bit software attempts to read a 64-bit counter, it should first halt the counter. Since this delays the interrupts for all of the timers, this should be done only if the consequences are understood. It is strongly recommended that 32-bit software only operate the timer in 32-bit mode.Reads to this register are monotonic. No two consecutive reads return the same value. The second of two reads always returns a larger value (unless the timer has rolled over to 0).



20.1.5 TIMn_CONF—Timer n Configuration and Capabilities Register

Address Offset:	Timer 0: 100–107h, Timer 1: 120–127h, Timer 2: 140–147h, Timer 3: 160–167h, Timer 4: 180–187h, Timer 5: 1A0–1A7h, Timer 6: 1C0–1C7h, Timer 7: 1E0–1E7h,	Attribute:	RO, R/W
Default Value:	N/A	Size:	64 bit

Note: The letter n can be 0, 1, 2, 3, 4, 5, 6, or 7 referring to Timer 0, 1, 2, 3, 4, 5, 6, or 7.

Bit	Description
63:56	Reserved. These bits will return 0 when read.
55:52, 43	<p>Timer Interrupt Rout Capability (TIMERn_INT_ROUT_CAP) — RO. Timer 0, 1: Bits 52, 53, 54, and 55 in this field (corresponding to IRQ 20, 21, 22, and 23) have a value of 1. Writes will have no effect. Timer 2: Bits 43, 52, 53, 54, and 55 in this field (corresponding to IRQ 11, 20, 21, 22, and 23) have a value of 1. Writes will have no effect. Timer 3: Bits 44, 52, 53, 54, and 55 in this field (corresponding to IRQ 11, 20, 21, 22, and 23) have a value of 1. Writes will have no effect. Timer 4, 5, 6, 7: This field is always 0 as interrupts from these timers can only be delivered using direct processor interrupt messages. NOTE: If IRQ 11 is used for HPET #2, software should ensure IRQ 11 is not shared with any other devices to ensure the proper operation of HPET #2. NOTE: If IRQ 12 is used for HPET #3, software should ensure IRQ 12 is not shared with any other devices to ensure the proper operation of HPET #3.</p>
51:45, 42:16	Reserved. These bits return 0 when read.
15	Timer n Processor Message Interrupt Delivery (Tn_PROCMSG_INT_DEL_CAP) — RO. This bit is always read as '1', since the PCH HPET implementation supports the direct processor interrupt delivery.
14	<p>Timer n Processor Message Interrupt Enable (Tn_PROCMSG_EN_CNF) — R/W / RO. If the Tn_PROCMSG_INT_DEL_CAP bit is set for this timer, then the software can set the Tn_PROCMSG_EN_CNF bit to force the interrupts to be delivered directly as processor messages, rather than using the 8259 or I/O (x) APIC. In this case, the Tn_INT_ROUT_CNF field in this register will be ignored. The Tn_PROCMSG_ROUT register will be used instead. Timer 0, 1, 2, 3 Specific: This bit is a read/write bit. Timer 4, 5, 6, 7 Specific: This bit is always Read Only '1' as interrupt from these timers can only be delivered using direct processor interrupt messages.</p>

Bit	Description
13:9	<p>Timer n Interrupt Rout (Tn_INT_ROUT_CNF) — R/W / RO. This 5-bit field indicates the routing for the interrupt to the 8259 or I/O (x) APIC. Software writes to this field to select which interrupt in the 8259 or I/O (x) will be used for this timer's interrupt. If the value is not supported by this particular timer, then the value read back will not match what is written. The software must only write valid values. Timer 4, 5, 6, 7: This field is Read Only and reads will return 0.</p> <p>NOTES:</p> <ol style="list-style-type: none"> 1. If the interrupt is handled using the 8259, only interrupts 0–15 are applicable and valid. Software must not program any value other than 0–15 in this field. 2. If the Legacy Replacement Rout bit is set, then Timers 0 and 1 will have a different routing, and this bit field has no effect for those two timers. 3. Timer 0,1: Software is responsible to make sure it programs a valid value (20, 21, 22, or 23) for this field. The PCH logic does not check the validity of the value written. 4. Timer 2: Software is responsible to make sure it programs a valid value (11, 20, 21, 22, or 23) for this field. The PCH logic does not check the validity of the value written. 5. Timer 3: Software is responsible to make sure it programs a valid value (12, 20, 21, 22, or 23) for this field. The PCH logic does not check the validity of the value written. 6. Timers 4, 5, 6, 7: This field is always Read Only 0 as interrupts from these timers can only be delivered using direct processor interrupt messages.
8	<p>Timer n 32-bit Mode (TIMERN_32MODE_CNF) — R/W or RO. Software can set this bit to force a 64-bit timer to behave as a 32-bit timer.</p> <p>Timer 0: Bit is read/write (default to 0). 0 = 64 bit; 1 = 32 bit</p> <p>Timers 1, 2, 3, 4, 5, 6, 7: Hardwired to 0. Writes have no effect (since these seven timers are 32-bits).</p> <p>NOTE: When this bit is set to 1, the hardware counter will do a 32-bit operation on comparator match and rollovers; thus, the upper 32-bit of the Timer 0 Comparator Value register is ignored. The upper 32-bit of the main counter is not involved in any rollover from lower 32-bit of the main counter and becomes all zeros.</p>
7	Reserved. This bit returns 0 when read.
6	<p>Timer n Value Set (TIMERN_VAL_SET_CNF) — R/W. Software uses this bit only for Timer 0 if it has been set to periodic mode. By writing this bit to a 1, the software is then allowed to directly set the timer's accumulator. Software does not have to write this bit back to 1 (it automatically clears).</p> <p>Software should not write a 1 to this bit position if the timer is set to non-periodic mode.</p> <p>NOTE: This bit will return 0 when read. Writes will only have an effect for Timer 0 if it is set to periodic mode. Writes will have no effect for Timers 1, 2, 3, 4, 5, 6, 7.</p>
5	<p>Timer n Size (TIMERN_SIZE_CAP) — RO. This read only field indicates the size of the timer.</p> <p>Timer 0: Value is 1 (64-bits).</p> <p>Timers 1, 2, 3, 4, 5, 6, 7: Value is 0 (32-bits).</p>
4	<p>Periodic Interrupt Capable (TIMERN_PER_INT_CAP) — RO. If this bit is 1, the hardware supports a periodic mode for this timer's interrupt.</p> <p>Timer 0: Hardwired to 1 (supports the periodic interrupt).</p> <p>Timers 1, 2, 3, 4, 5, 6, 7: Hardwired to 0 (does not support periodic interrupt).</p>



Bit	Description
3	<p>Timer n Type (TIMERn_TYPE_CNF) — R/W or RO.</p> <p>Timer 0: Bit is read/write. 0 = Disable timer to generate periodic interrupt; 1 = Enable timer to generate a periodic interrupt.</p> <p>Timers 1, 2, 3, 4, 5, 6, 7: Hardwired to 0. Writes have no affect.</p>
2	<p>Timer n Interrupt Enable (TIMERn_INT_ENB_CNF) — R/W. This bit must be set to enable timer n to cause an interrupt when it times out.</p> <p>0 = Disable (Default). The timer can still count and generate appropriate status bits, but will not cause an interrupt.</p> <p>1 = Enable.</p>
1	<p>Timer Interrupt Type (TIMERn_INT_TYPE_CNF) — R/W.</p> <p>0 = The timer interrupt is edge triggered. This means that an edge-type interrupt is generated. If another interrupt occurs, another edge will be generated.</p> <p>1 = The timer interrupt is level triggered. This means that a level-triggered interrupt is generated. The interrupt will be held active until it is cleared by writing to the bit in the General Interrupt Status Register. If another interrupt occurs before the interrupt is cleared, the interrupt will remain active.</p> <p>Timer 4, 5, 6, 7: This bit is Read Only, and will return 0 when read</p>
0	Reserved. These bits will return 0 when read.

NOTE: Reads or writes to unimplemented timers should not be attempted. Read from any unimplemented registers will return an undetermined value.

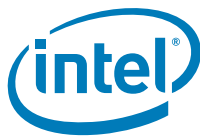

20.1.6 TIMn_COMP—Timer n Comparator Value Register

Address Offset: Timer 0: 108h–10Fh,
 Timer 1: 128h–12Fh,
 Timer 2: 148h–14Fh,
 Timer 3: 168h–16Fh,
 Timer 4: 188h–18Fh,
 Timer 5: 1A8h–1AFh,
 Timer 6: 1C8h–1CFh,
 Timer 7: 1E8h–1EFh

Attribute: R/W
 Default Value: N/A
 Size: 64 bit

Bit De	scription
63:0	<p>Timer Compare Value — R/W. Reads to this register return the current value of the comparator</p> <p>If Timer n is configured to non-periodic mode: Writes to this register load the value against which the main counter should be compared for this timer.</p> <ul style="list-style-type: none"> When the main counter equals the value last written to this register, the corresponding interrupt can be generated (if so enabled). The value in this register does not change based on the interrupt being generated. <p>If Timer 0 is configured to periodic mode:</p> <ul style="list-style-type: none"> When the main counter equals the value last written to this register, the corresponding interrupt can be generated (if so enabled). After the main counter equals the value in this register, the value in this register is increased by the value last written to the register. <p>For example, if the value written to the register is 00000123h, then</p> <ol style="list-style-type: none"> An interrupt will be generated when the main counter reaches 00000123h. The value in this register will then be adjusted by the hardware to 00000246h. Another interrupt will be generated when the main counter reaches 00000246h The value in this register will then be adjusted by the hardware to 00000369h <ul style="list-style-type: none"> As each periodic interrupt occurs, the value in this register will increment. When the incremented value is greater than the maximum value possible for this register (FFFFFFFFh for a 32-bit timer or FFFFFFFFFFFFFFFFh for a 64-bit timer), the value will wrap around through 0. For example, if the current value in a 32-bit timer is FFFF0000h and the last value written to this register is 20000h, then after the next interrupt the value will change to 00010000h <p>Default value for each timer is all 1s for the bits that are implemented. For example, a 32-bit timer has a default value of 00000000FFFFFFFFh. A 64-bit timer has a default value of FFFFFFFFFFFFFFFFh.</p>



20.1.7 TIMERN_PROCMMSG_ROUT—Timer n Processor Message Interrupt Rout Register

Address Offset: Timer 0: 110–117h, Attribute: R/W
 Timer 1: 130–137h,
 Timer 2: 150–157h,
 Timer 3: 170–177h,
 Timer 4: 190–197h,
 Timer 5: 1B0–1B7h,
 Timer 6: 1D0–1D7h,
 Timer 7: 1F0–1F7h,
 Default Value: N/A Size: 64 bit

Note: The letter n can be 0, 1, 2, 3, 4, 5, 6, or 7 referring to Timer 0, 1, 2, 3, 4, 5, 6, or 7.

Software can access the various bytes in this register using 32-bit or 64-bit accesses. 32-bit accesses can be done to offset 1x0h or 1x4h. 64-bit accesses can be done to 1x0h. 32-bit accesses must not be done to offsets 1x1h, 1x2h, 1x3h, 1x5h, 1x6h, or 1x7h.

Bit	Description
63:32	Tn_PROCMMSG_INT_ADDR — R/W. Software sets this 32-bit field to indicate the location that the direct processor interrupt message should be written.
31:0	Tn_PROCMMSG_INT_VAL — R/W. Software sets this 32-bit field to indicate that value that is written during the direct processor interrupt message.







21 Serial Peripheral Interface (SPI)

The Serial Peripheral Interface resides in memory mapped space. This function contains registers that allow for the setup and programming of devices that reside on the SPI interface.

Note: All registers in this function (including memory-mapped registers) must be addressable in byte, word, and DWord quantities. The software must always make register accesses on natural boundaries (that is, DWord accesses must be on DWord boundaries; word accesses on word boundaries, etc.) In addition, the memory-mapped register space must not be accessed with the LOCK semantic exclusive-access mechanism. If software attempts exclusive-access mechanisms to the SPI memory-mapped space, the results are undefined.

21.1 Serial Peripheral Interface Memory Mapped Configuration Registers

The SPI Host Interface registers are memory-mapped in the RCRB (Root Complex Register Block) Chipset Register Space with a base address (SPIBAR) of 3800h and are located within the range of 3800h to 39FFh. The address for RCRB can be found in RCBA Register see [Section 13.1.37](#). The individual registers are then accessible at SPIBAR + Offset as indicated in the following table.

These memory mapped registers must be accessed in byte, word, or DWord quantities.

Table 21-1. Serial Peripheral Interface (SPI) Register Address Map (SPI Memory Mapped Configuration Registers) (Sheet 1 of 2)

SPIBAR + Offset	Mnemonic	Register Name	Default
00h–03h	BFPR	BIOS Flash Primary Region	00000000h
04h–05h	HSFS	Hardware Sequencing Flash Status	0000h
06h–07h	HSFC	Hardware Sequencing Flash Control	0000h
08h–0Bh	FADDR	Flash Address	00000000h
0Ch–0Fh	—	Reserved	00000000h
10h–13h	FDATA0	Flash Data 0	00000000h
14h–4Fh	FDATAN	Flash Data N	00000000h
50h–53h	FRAP	Flash Region Access Permissions	0000202h
54h–57h	FREG0	Flash Region 0	00000000h
58h–5Bh	FREG1	Flash Region 1	00000000h
5Ch–5Fh	FREG2	Flash Region 2	00000000h
60h–63h	FREG3	Flash Region 3	00000000h
64h–67h	FREG4	Flash Region 4	00000000h
67h–73h	—	Reserved for Future Flash Regions	
74h–77h	PR0	Flash Protected Range 0	00000000h



Table 21-1. Serial Peripheral Interface (SPI) Register Address Map (SPI Memory Mapped Configuration Registers) (Sheet 2 of 2)

SPIBAR + Offset	Mnemonic	Register Name	Default
78h-7Bh	PR1	Flash Protected Range 1	00000000h
7Ch-7Fh	PR2	Flash Protected Range 2	00000000h
80h-83h	PR3	Flash Protected Range 3	00000000h
84h-87h	PR4	Flash Protected Range 4	00000000h
88h-8Fh	—	Reserved	—
90h	SSFS	Software Sequencing Flash Status	00h
91h-93h	SSFC	Software Sequencing Flash Control	0000h
94h-95h	PREOP	Prefix Opcode Configuration	0000h
96h-97h	OPTYPE	Opcode Type Configuration	0000h
98h-9Fh	OPMENU	Opcode Menu Configuration	0000000000000000h
A0h	BBAR	BIOS Base Address Configuration	00000000h
B0h-B3h	FDOC	Flash Descriptor Observability Control	00000000h
B4h-B7h	FDOD	Flash Descriptor Observability Data	00000000h
B8h-C3h	—	Reserved	—
C0h-C3h	AFC	Additional Flash Control	00000000h
C4h-C7h	LVSCC	Host Lower Vendor Specific Component Capabilities	00000000h
C8h-C11h	UVSCC	Host Upper Vendor Specific Component Capabilities	00000000h
D0h-D3h	FPB	Flash Partition Boundary	00000000h
F0h-F3h	SRDL	Soft Reset Data Lock	00000000h
F4h-F7h	SRDC	Soft Reset Data Control	00000000h
F8h-FBh	SRD	Soft Reset Data	00000000h



21.1.1 BFPR – BIOS Flash Primary Region Register (SPI Memory Mapped Configuration Registers)

Memory Address: SPIBAR + 00h Attribute: RO
 Default Value: 00000000h Size: 32 bits

Note: This register is only applicable when SPI device is in descriptor mode.

Bit	Description
31:29	Reserved
28:16	BIOS Flash Primary Region Limit (PRL) – RO. This specifies address bits 24:12 for the Primary Region Limit. The value in this register loaded from the contents in the Flash Descriptor.FLREG1.Region Limit
15:13	Reserved
12:0	BIOS Flash Primary Region Base (PRB) – RO. This specifies address bits 24:12 for the Primary Region Base The value in this register is loaded from the contents in the Flash Descriptor.FLREG1.Region Base

21.1.2 HSFS—Hardware Sequencing Flash Status Register (SPI Memory Mapped Configuration Registers)

Memory Address: SPIBAR + 04h Attribute: RO, R/WC, R/W
 Default Value: 0000h Size: 16 bits

Bit	Description
15	Flash Configuration Lock-Down (FLOCKDN) – R/W/L. When set to 1, those Flash Program Registers that are locked down by this FLOCKDN bit cannot be written. Once set to 1, this bit can only be cleared by a hardware reset due to a global reset or host partition reset in an Intel® ME enabled system.
14	Flash Descriptor Valid (FDV) – RO. This bit is set to a 1 if the Flash Controller read the correct Flash Descriptor Signature. If the Flash Descriptor Valid bit is not 1, software cannot use the Hardware Sequencing registers, but must use the software sequencing registers. Any attempt to use the Hardware Sequencing registers will result in the FCERR bit being set.
13	Flash Descriptor Override Pin-Strap Status (FDOPSS) – RO. This bit indicates the condition of the Flash Descriptor Security Override / Intel ME Debug Mode Pin-Strap. 0 = The Flash Descriptor Security Override / Intel ME Debug Mode strap is set using external pull-up on HDA_SDO 1 = No override
12:6	Reserved
5	SPI Cycle In Progress (SCIP) – RO. Hardware sets this bit when software sets the Flash Cycle Go (FGO) bit in the Hardware Sequencing Flash Control register. This bit remains set until the cycle completes on the SPI interface. Hardware automatically sets and clears this bit so that software can determine when read data is valid and/or when it is safe to begin programming the next command. Software must only program the next command when this bit is 0. NOTE: This field is only applicable when in Descriptor mode and Hardware sequencing is being used.



Bit	Description
4:3	<p>Block/Sector Erase Size (BERASE) — RO. This field identifies the erasable sector size for all Flash components.</p> <p>Valid Bit Settings:</p> <p>00 = 256 Byte</p> <p>01 = 4 K Byte</p> <p>10 = 8 K Byte</p> <p>11 = 64 K Byte</p> <p>If the FLA is less than FPBA, then this field reflects the value in the LVSCC.LBES register.</p> <p>If the FLA is greater or equal to FPBA, then this field reflects the value in the UVSCC.UBES register.</p> <p>NOTE: This field is only applicable when in Descriptor mode and Hardware sequencing is being used.</p>
2	<p>Access Error Log (AEL) — R/W/C. Hardware sets this bit to a 1 when an attempt was made to access the BIOS region using the direct access method or an access to the BIOS Program Registers that violated the security restrictions. This bit is simply a log of an access security violation. This bit is cleared by software writing a 1.</p> <p>NOTE: This field is only applicable when in Descriptor mode and Hardware sequencing is being used.</p>
1	<p>Flash Cycle Error (FCERR) — R/W/C. Hardware sets this bit to 1 when a program register access is blocked to the FLASH due to one of the protection policies or when any of the programmed cycle registers is written while a programmed access is already in progress. This bit remains asserted until cleared by software writing a 1 or until hardware reset occurs due to a global reset or host partition reset in an Intel® ME enabled system. Software must clear this bit before setting the FLASH Cycle GO bit in this register.</p> <p>NOTE: This field is only applicable when in Descriptor mode and Hardware sequencing is being used.</p>
0	<p>Flash Cycle Done (FDONE) — R/W/C. The PCH sets this bit to 1 when the SPI Cycle completes after software previously set the FGO bit. This bit remains asserted until cleared by software writing a 1 or hardware reset due to a global reset or host partition reset in an Intel® ME enabled system. When this bit is set and the SPI SMI# Enable bit is set, an internal signal is asserted to the SMI# generation block. Software must make sure this bit is cleared prior to enabling the SPI SMI# assertion for a new programmed access.</p> <p>NOTE: This field is only applicable when in Descriptor mode and Hardware sequencing is being used.</p>



21.1.3 HSFC—Hardware Sequencing Flash Control Register (SPI Memory Mapped Configuration Registers)

Memory Address: SPIBAR + 06h Attribute: R/W, R/WS
 Default Value: 0000h Size: 16 bits

Note: This register is only applicable when SPI device is in descriptor mode.

Bit	Description
15	Flash SPI SMI# Enable (FSMIE) — R/W. When set to 1, the SPI asserts an SMI# request whenever the Flash Cycle Done bit is 1.
14	Reserved
13:8	Flash Data Byte Count (FDBC) — R/W. This field specifies the number of bytes to shift in or out during the data portion of the SPI cycle. The contents of this register are 0s based with 0b representing 1 byte and 111111b representing 64 bytes. The number of bytes transferred is the value of this field plus 1. This field is ignored for the Block Erase command.
7:3	Reserved
2:1	FLASH Cycle (FCYCLE) — R/W. This field defines the Flash SPI cycle type generated to the FLASH when the FGO bit is set as defined below: 00 = Read (1 up to 64 bytes by setting FDBC) 01 = Reserved 10 = Write (1 up to 64 bytes by setting FDBC) 11 = Block Erase
0	Flash Cycle Go (FGO) — R/W/S. A write to this register with a 1 in this bit initiates a request to the Flash SPI Arbiter to start a cycle. This register is cleared by hardware when the cycle is granted by the SPI arbiter to run the cycle on the SPI bus. When the cycle is complete, the FDONE bit is set. Software is forbidden to write to any register in the HSFLCTL register between the FGO bit getting set and the FDONE bit being cleared. Any attempt to violate this rule will be ignored by hardware. Hardware allows other bits in this register to be programmed for the same transaction when writing this bit to 1. This saves an additional memory write. This bit always returns 0 on reads.

21.1.4 FADDR—Flash Address Register (SPI Memory Mapped Configuration Registers)

Memory Address: SPIBAR + 08h Attribute: R/W
 Default Value: 00000000h Size: 32 bits

Bit	Description
31:25	Reserved
24:0	Flash Linear Address (FLA) — R/W. The FLA is the starting byte linear address of a SPI Read or Write cycle or an address within a Block for the Block Erase command. The Flash Linear Address must fall within a region for which BIOS has access permissions. Hardware must convert the FLA into a Flash Physical Address (FPA) before running this cycle on the SPI bus.



21.1.5 FDATA0—Flash Data 0 Register (SPI Memory Mapped Configuration Registers)

Memory Address: SPIBAR + 10h Attribute: R/W
Default Value: 00000000h Size: 32 bits

Bit	Description
31:0	<p>Flash Data 0 (FD0) — R/W. This field is shifted out as the SPI Data on the Master-Out Slave-In Data pin during the data portion of the SPI cycle.</p> <p>This register also shifts in the data from the Master-In Slave-Out pin into this register during the data portion of the SPI cycle.</p> <p>The data is always shifted starting with the least significant byte, msb to lsb, followed by the next least significant byte, msb to lsb, etc. Specifically, the shift order on SPI in terms of bits within this register is: 7-6-5-4-3-2-1-0-15-14-13-...8-23-22-...16-31...24 Bit 24 is the last bit shifted out/in. There are no alignment assumptions; byte 0 always represents the value specified by the cycle address.</p> <p>Note that the data in this register may be modified by the hardware during any programmed SPI transaction. Direct Memory Reads do not modify the contents of this register.</p>

21.1.6 FDATA[N]—Flash Data [N] Register (SPI Memory Mapped Configuration Registers)

Memory Address: SPIBAR + 14h Attribute: R/W
 SPIBAR + 18h
 SPIBAR + 1Ch
 SPIBAR + 20h
 SPIBAR + 24h
 SPIBAR + 28h
 SPIBAR + 2Ch
 SPIBAR + 30h
 SPIBAR + 34h
 SPIBAR + 38h
 SPIBAR + 3Ch
 SPIBAR + 40h
 SPIBAR + 44h
 SPIBAR + 48h
 SPIBAR + 4Ch

Default Value: 00000000h Size: 32 bits

Bit	Description
31:0	<p>Flash Data N (FD[N]) — R/W. Similar definition as Flash Data 0. However, this register does not begin shifting until FD[N-1] has completely shifted in/out.</p>



21.1.7 FRAP—Flash Regions Access Permissions Register (SPI Memory Mapped Configuration Registers)

Memory Address: SPIBAR + 50h Attribute: RO, R/W
 Default Value: 00000202h Size: 32 bits

Note: This register is only applicable when SPI device is in descriptor mode.

Bit	Description
31:24	<p>BIOS Master Write Access Grant (BMWAG) — R/W. Each bit [31:29] corresponds to Master[7:0]. BIOS can grant one or more masters write access to the BIOS region 1 overriding the permissions in the Flash Descriptor.</p> <p>Master[1] is Host processor/BIOS, Master[2] is Intel® Management Engine, Master[3] is Host processor/GbE. Master[0] and Master[7:4] are reserved.</p> <p>The contents of this register are locked by the FLOCKDN bit.</p>
23:16	<p>BIOS Master Read Access Grant (BMRAG) — R/W. Each bit [28:16] corresponds to Master[7:0]. BIOS can grant one or more masters read access to the BIOS region 1 overriding the read permissions in the Flash Descriptor.</p> <p>Master[1] is Host processor/BIOS, Master[2] is Intel® Management Engine, Master[3] is Host processor/GbE. Master[0] and Master[7:4] are reserved.</p> <p>The contents of this register are locked by the FLOCKDN bit</p>
15:8	<p>BIOS Region Write Access (BRWA) — RO. Each bit [15:8] corresponds to Regions [7:0]. If the bit is set, this master can erase and write that particular region through register accesses.</p> <p>The contents of this register are that of the Flash Descriptor. Flash Master 1 Master Region Write Access OR a particular master has granted BIOS write permissions in their Master Write Access Grant register or the Flash Descriptor Security Override strap is set.</p>
7:0	<p>BIOS Region Read Access (BRR) — RO. Each bit [7:0] corresponds to Regions [7:0]. If the bit is set, this master can read that particular region through register accesses.</p> <p>The contents of this register are that of the Flash Descriptor. Flash Master 1 Master Region Write Access OR a particular master has granted BIOS read permissions in their Master Read Access Grant register or the Flash Descriptor Security Override strap is set.</p>



21.1.8 FREG0—Flash Region 0 (Flash Descriptor) Register (SPI Memory Mapped Configuration Registers)

Memory Address: SPIBAR + 54h Attribute: RO
Default Value: 00000000h Size: 32 bits

Note: This register is only applicable when SPI device is in descriptor mode.

Bit	Description
31:29	Reserved
28:16	Region Limit (RL) — RO. This specifies address bits 24:12 for the Region 0 Limit. The value in this register is loaded from the contents in the Flash Descriptor.FLREG0.Region Limit.
15:13	Reserved
12:0	Region Base (RB) / Flash Descriptor Base Address Region (FDBAR) — RO. This specifies address bits 24:12 for the Region 0 Base. The value in this register is loaded from the contents in the Flash Descriptor.FLREG0.Region Base.

21.1.9 FREG1—Flash Region 1 (BIOS Descriptor) Register (SPI Memory Mapped Configuration Registers)

Memory Address: SPIBAR + 58h Attribute: RO
Default Value: 00000000h Size: 32 bits

Note: This register is only applicable when SPI device is in descriptor mode.

Bit	Description
31:29	Reserved
28:16	Region Limit (RL) — RO. This specifies address bits 24:12 for the Region 1 Limit. The value in this register is loaded from the contents in the Flash Descriptor.FLREG1.Region Limit.
15:13	Reserved
12:0	Region Base (RB) — RO. This specifies address bits 24:12 for the Region 1 Base. The value in this register is loaded from the contents in the Flash Descriptor.FLREG1.Region Base.



21.1.10 FREG2—Flash Region 2 (Intel® ME) Register (SPI Memory Mapped Configuration Registers)

Memory Address: SPIBAR + 5Ch Attribute: RO
 Default Value: 00000000h Size: 32 bits

Note: This register is only applicable when SPI device is in descriptor mode.

Bit	Description
31:29	Reserved
28:16	Region Limit (RL) — RO. This specifies address bits 24:12 for the Region 2 Limit. The value in this register is loaded from the contents in the Flash Descriptor.FLREG2.Region Limit.
15:13	Reserved
12:0	Region Base (RB) — RO. This specifies address bits 24:12 for the Region 2 Base. The value in this register is loaded from the contents in the Flash Descriptor.FLREG2.Region Base

21.1.11 FREG3—Flash Region 3 (GbE) Register (SPI Memory Mapped Configuration Registers)

Memory Address: SPIBAR + 60h Attribute: RO
 Default Value: 00000000h Size: 32 bits

Note: This register is only applicable when SPI device is in descriptor mode.

Bit	Description
31:29	Reserved
28:16	Region Limit (RL) — RO. This specifies address bits 24:12 for the Region 3 Limit. The value in this register is loaded from the contents in the Flash Descriptor.FLREG3.Region Limit.
15:13	Reserved
12:0	Region Base (RB) — RO. This specifies address bits 24:12 for the Region 3 Base. The value in this register is loaded from the contents in the Flash Descriptor.FLREG3.Region Base



21.1.12 FREG4—Flash Region 4 (Platform Data) Register (SPI Memory Mapped Configuration Registers)

Memory Address: SPIBAR + 64h Attribute: RO
Default Value: 00000000h Size: 32 bits

Note: This register is only applicable when SPI device is in descriptor mode.

Bit	Description
31:29	Reserved
28:16	Region Limit (RL) — RO. This specifies address bits 24:12 for the Region 4 Limit. The value in this register is loaded from the contents in the Flash Descriptor.FLREG4.Region Limit.
15:13	Reserved
12:0	Region Base (RB) — RO. This specifies address bits 24:12 for the Region 4 Base. The value in this register is loaded from the contents in the Flash Descriptor.FLREG4.Region Base.

21.1.13 PR0—Protected Range 0 Register (SPI Memory Mapped Configuration Registers)

Memory Address: SPIBAR + 74h Attribute: R/W
Default Value: 00000000h Size: 32 bits

Note: This register can not be written when the FLOCKDN bit is set to 1.

Bit	Description
31	Write Protection Enable — R/W. When set, this bit indicates that the Base and Limit fields in this register are valid and that writes and erases directed to addresses between them (inclusive) must be blocked by hardware. The base and limit fields are ignored when this bit is cleared.
30:29	Reserved
28:16	Protected Range Limit — R/W. This field corresponds to FLA address bits 24:12 and specifies the upper limit of the protected range. Address bits 11:0 are assumed to be FFFh for the limit comparison. Any address greater than the value programmed in this field is unaffected by this protected range.
15	Read Protection Enable — R/W. When set, this bit indicates that the Base and Limit fields in this register are valid and that read directed to addresses between them (inclusive) must be blocked by hardware. The base and limit fields are ignored when this bit is cleared.
14:13	Reserved
12:0	Protected Range Base — R/W. This field corresponds to FLA address bits 24:12 and specifies the lower base of the protected range. Address bits 11:0 are assumed to be 000h for the base comparison. Any address less than the value programmed in this field is unaffected by this protected range.



21.1.14 PR1—Protected Range 1 Register (SPI Memory Mapped Configuration Registers)

Memory Address: SPIBAR + 78h Attribute: R/W
 Default Value: 00000000h Size: 32 bits

Note: This register can not be written when the FLOCKDN bit is set to 1.

Bit	Description
31	Write Protection Enable — R/W. When set, this bit indicates that the Base and Limit fields in this register are valid and that writes and erases directed to addresses between them (inclusive) must be blocked by hardware. The base and limit fields are ignored when this bit is cleared.
30:29	Reserved
28:16	Protected Range Limit — R/W. This field corresponds to FLA address bits 24:12 and specifies the upper limit of the protected range. Address bits 11:0 are assumed to be FFFh for the limit comparison. Any address greater than the value programmed in this field is unaffected by this protected range.
15	Read Protection Enable — R/W. When set, this bit indicates that the Base and Limit fields in this register are valid and that read directed to addresses between them (inclusive) must be blocked by hardware. The base and limit fields are ignored when this bit is cleared.
14:13	Reserved
12:0	Protected Range Base — R/W. This field corresponds to FLA address bits 24:12 and specifies the lower base of the protected range. Address bits 11:0 are assumed to be 000h for the base comparison. Any address less than the value programmed in this field is unaffected by this protected range.



21.1.15 PR2—Protected Range 2 Register (SPI Memory Mapped Configuration Registers)

Memory Address: SPIBAR + 7Ch Attribute: R/W
Default Value: 00000000h Size: 32 bits

Note: This register can not be written when the FLOCKDN bit is set to 1.

Bit	Description
31	Write Protection Enable — R/W. When set, this bit indicates that the Base and Limit fields in this register are valid and that writes and erases directed to addresses between them (inclusive) must be blocked by hardware. The base and limit fields are ignored when this bit is cleared.
30:29	Reserved
28:16	Protected Range Limit — R/W. This field corresponds to FLA address bits 24:12 and specifies the upper limit of the protected range. Address bits 11:0 are assumed to be FFFh for the limit comparison. Any address greater than the value programmed in this field is unaffected by this protected range.
15	Read Protection Enable — R/W. When set, this bit indicates that the Base and Limit fields in this register are valid and that read directed to addresses between them (inclusive) must be blocked by hardware. The base and limit fields are ignored when this bit is cleared.
14:13	Reserved
12:0	Protected Range Base — R/W. This field corresponds to FLA address bits 24:12 and specifies the lower base of the protected range. Address bits 11:0 are assumed to be 000h for the base comparison. Any address less than the value programmed in this field is unaffected by this protected range.



21.1.16 PR3—Protected Range 3 Register (SPI Memory Mapped Configuration Registers)

Memory Address: SPIBAR + 80h Attribute: R/W
 Default Value: 00000000h Size: 32 bits

Note: This register can not be written when the FLOCKDN bit is set to 1.

Bit	Description
31	Write Protection Enable — R/W. When set, this bit indicates that the Base and Limit fields in this register are valid and that writes and erases directed to addresses between them (inclusive) must be blocked by hardware. The base and limit fields are ignored when this bit is cleared.
30:29	Reserved
28:16	Protected Range Limit — R/W. This field corresponds to FLA address bits 24:12 and specifies the upper limit of the protected range. Address bits 11:0 are assumed to be FFFh for the limit comparison. Any address greater than the value programmed in this field is unaffected by this protected range.
15	Read Protection Enable — R/W. When set, this bit indicates that the Base and Limit fields in this register are valid and that read directed to addresses between them (inclusive) must be blocked by hardware. The base and limit fields are ignored when this bit is cleared.
14:13	Reserved
12:0	Protected Range Base — R/W. This field corresponds to FLA address bits 24:12 and specifies the lower base of the protected range. Address bits 11:0 are assumed to be 000h for the base comparison. Any address less than the value programmed in this field is unaffected by this protected range.



21.1.17 PR4—Protected Range 4 Register (SPI Memory Mapped Configuration Registers)

Memory Address: SPIBAR + 84h Attribute: R/W
Default Value: 00000000h Size: 32 bits

Note: This register can not be written when the FLOCKDN bit is set to 1.

Bit	Description
31	Write Protection Enable — R/W. When set, this bit indicates that the Base and Limit fields in this register are valid and that writes and erases directed to addresses between them (inclusive) must be blocked by hardware. The base and limit fields are ignored when this bit is cleared.
30:29	Reserved
28:16	Protected Range Limit — R/W. This field corresponds to FLA address bits 24:12 and specifies the upper limit of the protected range. Address bits 11:0 are assumed to be FFFh for the limit comparison. Any address greater than the value programmed in this field is unaffected by this protected range.
15	Read Protection Enable — R/W. When set, this bit indicates that the Base and Limit fields in this register are valid and that read directed to addresses between them (inclusive) must be blocked by hardware. The base and limit fields are ignored when this bit is cleared.
14:13	Reserved
12:0	Protected Range Base — R/W. This field corresponds to FLA address bits 24:12 and specifies the lower base of the protected range. Address bits 11:0 are assumed to be 000h for the base comparison. Any address less than the value programmed in this field is unaffected by this protected range.



21.1.18 SSFS—Software Sequencing Flash Status Register (SPI Memory Mapped Configuration Registers)

Memory Address: SPIBAR + 90h Attribute: RO, R/WC
 Default Value: 00h Size: 8 bits

Note: The Software Sequencing control and status registers are reserved if the hardware sequencing control and status registers are used.

Bit	Description
7:5	Reserved
4	Access Error Log (AEL) — RO. This bit reflects the value of the Hardware Sequencing Status AEL register.
3	Flash Cycle Error (FCERR) — R/WC. Hardware sets this bit to 1 when a programmed access is blocked from running on the SPI interface due to one of the protection policies or when any of the programmed cycle registers is written while a programmed access is already in progress. This bit remains asserted until cleared by software writing a 1 or hardware reset due to a global reset or host partition reset in an Intel® ME enabled system.
2	Cycle Done Status — R/WC. The PCH sets this bit to 1 when the SPI Cycle completes (that is, SCIP bit is 0) after software sets the GO bit. This bit remains asserted until cleared by software writing a 1 or hardware reset due to a global reset or host partition reset in an Intel® ME enabled system. When this bit is set and the SPI SMI# Enable bit is set, an internal signal is asserted to the SMI# generation block. Software must make sure this bit is cleared prior to enabling the SPI SMI# assertion for a new programmed access.
1	Reserved
0	SPI Cycle In Progress (SCIP) — RO. Hardware sets this bit when software sets the SPI Cycle Go bit in the Command register. This bit remains set until the cycle completes on the SPI interface. Hardware automatically sets and clears this bit so that software can determine when read data is valid and/or when it is safe to begin programming the next command. Software must only program the next command when this bit is 0.



21.1.19 SSFC—Software Sequencing Flash Control Register (SPI Memory Mapped Configuration Registers)

Memory Address: SPIBAR + 91h Attribute: R/W
 Default Value: F80000h Size: 24 bits

Bit	Description
23:19	Reserved – BIOS must set this field to '11111'b
18:16	<p>SPI Cycle Frequency (SCF) — R/W. This register sets frequency to use for all SPI software sequencing cycles (write, erase, fast read, read status, etc.) except for the read cycle which always run at 20 MHz.</p> <p>000 = 20 MHz 001 = 33 MHz 100 = 50 MHz All other values reserved. This register is locked when the SPI Configuration Lock-Down bit is set.</p>
15	<p>SPI SMI# Enable (SME) — R/W. When set to 1, the SPI asserts an SMI# request whenever the Cycle Done Status bit is 1.</p>
14	<p>Data Cycle (DS) — R/W. When set to 1, there is data that corresponds to this transaction. When 0, no data is delivered for this cycle, and the DBC and data fields themselves are don't cares.</p>
13:8	<p>Data Byte Count (DBC) — R/W. This field specifies the number of bytes to shift in or out during the data portion of the SPI cycle. The valid settings (in decimal) are any value from 0 to 63. The number of bytes transferred is the value of this field plus 1.</p> <p>Note that when this field is 00_0000b, then there is 1 byte to transfer and that 11_1111b means there are 64 bytes to transfer.</p>
7	Reserved
6:4	<p>Cycle Opcode Pointer (COP) — R/W. This field selects one of the programmed opcodes in the Opcode Menu to be used as the SPI Command/Opcode. In the case of an Atomic Cycle Sequence, this determines the second command.</p>
3	<p>Sequence Prefix Opcode Pointer (SPOP) — R/W. This field selects one of the two programmed prefix opcodes for use when performing an Atomic Cycle Sequence. A value of 0 points to the opcode in the least significant byte of the Prefix Opcodes register. By making this programmable, the PCH supports flash devices that have different opcodes for enabling writes to the data space versus status register.</p>
2	<p>Atomic Cycle Sequence (ACS) — R/W. When set to 1 along with the SCGO assertion, the PCH will execute a sequence of commands on the SPI interface without allowing the LAN component to arbitrate and interleave cycles. The sequence is composed of:</p> <ul style="list-style-type: none"> • Atomic Sequence Prefix Command (8-bit opcode only) • Primary Command specified below by software (can include address and data) • Polling the Flash Status Register (opcode 05h) until bit 0 becomes 0b. <p>The SPI Cycle in Progress bit remains set and the Cycle Done Status bit remains unset until the Busy bit in the Flash Status Register returns 0.</p>
1	<p>SPI Cycle Go (SCGO) — R/WS. This bit always returns 0 on reads. However, a write to this register with a 1 in this bit starts the SPI cycle defined by the other bits of this register. The "SPI Cycle in Progress" (SCIP) bit gets set by this action. Hardware must ignore writes to this bit while the Cycle In Progress bit is set. Hardware allows other bits in this register to be programmed for the same transaction when writing this bit to 1. This saves an additional memory write.</p>
0	Reserved



21.1.20 PREOP—Prefix Opcode Configuration Register (SPI Memory Mapped Configuration Registers)

Memory Address: SPIBAR + 94h Attribute: R/W
 Default Value: 0000h Size: 16 bits

Bit	Description
15:8	Prefix Opcode 1 — R/W. Software programs an SPI opcode into this field that is permitted to run as the first command in an atomic cycle sequence.
7:0	Prefix Opcode 0 — R/W. Software programs an SPI opcode into this field that is permitted to run as the first command in an atomic cycle sequence.

NOTE: This register is not writable when the Flash Configuration Lock-Down bit (SPIBAR + 04h:15) is set.

21.1.21 OPTYPE—Opcode Type Configuration Register (SPI Memory Mapped Configuration Registers)

Memory Address: SPIBAR + 96h Attribute: R/W
 Default Value: 0000h Size: 16 bits

Entries in this register correspond to the entries in the Opcode Menu Configuration register.

Note: The definition below only provides write protection for opcodes that have addresses associated with them. Therefore, any erase or write opcodes that do not use an address should be avoided (for example, “Chip Erase” and “Auto-Address Increment Byte Program”)

Bit	Description
15:14	Opcode Type 7 — R/W. See the description for bits 1:0
13:12	Opcode Type 6 — R/W. See the description for bits 1:0
11:10	Opcode Type 5 — R/W. See the description for bits 1:0
9:8	Opcode Type 4 — R/W. See the description for bits 1:0
7:6	Opcode Type 3 — R/W. See the description for bits 1:0
5:4	Opcode Type 2 — R/W. See the description for bits 1:0
3:2	Opcode Type 1 — R/W. See the description for bits 1:0
1:0	<p>Opcode Type 0 — R/W. This field specifies information about the corresponding Opcode 0. This information allows the hardware to 1) know whether to use the address field and 2) provide BIOS and Shared Flash protection capabilities. The encoding of the two bits is:</p> <p>00 = No address associated with this Opcode; Read cycle type 01 = No address associated with this Opcode; Write cycle type 10 = Address required; Read cycle type 11 = Address required; Write cycle type</p>

NOTE: This register is not writable when the SPI Configuration Lock-Down bit (SPIBAR + 00h:15) is set.



21.1.22 OPMENU—Opcode Menu Configuration Register (SPI Memory Mapped Configuration Registers)

Memory Address: SPIBAR + 98h Attribute: R/W
Default Value: 0000000000000000h Size: 64 bits

Eight entries are available in this register to give BIOS a sufficient set of commands for communicating with the flash device, while also restricting what malicious software can do. This keeps the hardware flexible enough to operate with a wide variety of SPI devices.

Note: It is recommended that BIOS avoid programming Write Enable opcodes in this menu. Malicious software could then perform writes and erases to the SPI flash without using the atomic cycle mechanism. This could cause functional failures in a shared flash environment. Write Enable opcodes should only be programmed in the Prefix Opcodes.

Bit	Description
63:56	Allowable Opcode 7 — R/W. See the description for bits 7:0
55:48	Allowable Opcode 6 — R/W. See the description for bits 7:0
47:40	Allowable Opcode 5 — R/W. See the description for bits 7:0
39:32	Allowable Opcode 4 — R/W. See the description for bits 7:0
31:24	Allowable Opcode 3 — R/W. See the description for bits 7:0
23:16	Allowable Opcode 2 — R/W. See the description for bits 7:0
15:8	Allowable Opcode 1 — R/W. See the description for bits 7:0
7:0	Allowable Opcode 0 — R/W. Software programs an SPI opcode into this field for use when initiating SPI commands through the Control Register.

This register is not writable when the SPI Configuration Lock-Down bit (SPIBAR + 00h:15) is set.



21.1.23 BBAR—BIOS Base Address Configuration Register (SPI Memory Mapped Configuration Registers)

Memory Address: SPIBAR + A0h Attribute: R/W, RO
 Default Value: 00000000h Size: 32 bits

Eight entries are available in this register to give BIOS a sufficient set of commands for communicating with the flash device, while also restricting what malicious software can do. This keeps the hardware flexible enough to operate with a wide variety of SPI devices.

Bit	Description
31:24	Reserved
23:8	<p>Bottom of System Flash— R/W. This field determines the bottom of the System BIOS. The PCH will not run programmed commands nor memory reads whose address field is less than this value. this field corresponds to bits 23:8 of the 3-byte address; bits 7:0 are assumed to be 00h for this vector when comparing to a potential SPI address.</p> <p>NOTE: The SPI host controller prevents any programmed cycle using the address register with an address less than the value in this register. Some flash devices specify that the Read ID command must have an address of 0000h or 0001h. If this command must be supported with these devices, it must be performed with the BIOS BAR.</p>
7:0	Reserved

21.1.24 FDOC—Flash Descriptor Observability Control Register (SPI Memory Mapped Configuration Registers)

Memory Address: SPIBAR + B0h Attribute: R/W
 Default Value: 00000000h Size: 32 bits

Note: This register that can be used to observe the contents of the Flash Descriptor that is stored in the PCH Flash Controller. This register is only applicable when SPI device is in descriptor mode.

Bit	Description
31:15	Reserved
14:12	<p>Flash Descriptor Section Select (FDSS) — R/W. Selects which section within the loaded Flash Descriptor to observe.</p> <p>000 = Flash Signature and Descriptor Map 001 = Component 010 = Region 011 = Master 111 = Reserved</p>
11:2	<p>Flash Descriptor Section Index (FDSI) — R/W. Selects the DW offset within the Flash Descriptor Section to observe.</p>
1:0	Reserved



21.1.25 FDOD—Flash Descriptor Observability Data Register (SPI Memory Mapped Configuration Registers)

Memory Address: SPIBAR + B4h Attribute: RO
 Default Value: 00000000h Size: 32 bits

Note: This register that can be used to observe the contents of the Flash Descriptor that is stored in the PCH Flash Controller.

Bit	Description
31:0	Flash Descriptor Section Data (FDSD) — RO. Returns the DW of data to observe as selected in the Flash Descriptor Observability Control.

21.1.26 AFC—Additional Flash Control Register (SPI Memory Mapped Configuration Registers)

Memory Address: SPIBAR + C0h Attribute: RO, R/W
 Default Value: 00000000h Size: 32 bits.

Bit	Description
31:3	Reserved
2:1	Flash Controller Interface Dynamic Clock Gating Enable — R/W. 0 = Flash Controller Interface Dynamic Clock Gating is Disabled 1 = Flash Controller Interface Dynamic Clock Gating is Enabled Other configurations are Reserved.
0	Flash Controller Core Dynamic Clock Gating Enable — R/W. 0 = Flash Controller Core Dynamic Clock Gating is Disabled 1 = Flash Controller Core Dynamic Clock Gating is Enabled

21.1.27 LVSCC— Host Lower Vendor Specific Component Capabilities Register (SPI Memory Mapped Configuration Registers)

Memory Address: SPIBAR + C4h Attribute: RO, R/WL
 Default Value: 00000000h Size: 32 bits

Note: All attributes described in LVSCC must apply to all flash space below the FPBA, even if it spans between two separate flash parts. This register is only applicable when SPI device is in descriptor mode.

Bit	Description
31:24	Reserved
23	Vendor Component Lock (LVCL) — R/W. This register locks itself when set. 0 = The lock bit is not set 1 = The Vendor Component Lock bit is set. NOTE: This bit applies to both UVSCC and LVSCC registers.
22:16	Reserved
15:8	Lower Erase Opcode (LEO) — R/W. This register is programmed with the Flash erase instruction opcode required by the vendor's Flash component. This register is locked by the Vendor Component Lock (LVCL) bit.



Bit	Description
7:5	Reserved
4	<p>Write Enable on Write Status (LWEWS) — R/W. This register is locked by the Vendor Component Lock (LVCL) bit.</p> <p>0 = No automatic write of 00h will be made to the SPI flash's status register) 1 = A write of 00h to the SPI flash's status register will be sent on EVERY write and erase to the SPI flash. 06h 01h 00h is the opcode sequence used to unlock the Status register.</p> <p>NOTES:</p> <ol style="list-style-type: none"> 1. This bit should not be set to 1 if there are non-volatile bits in the SPI flash's status register. This may lead to premature flash wear out. 2. This is not an atomic sequence. If the SPI component's status register is non-volatile, then BIOS should issue an atomic software sequence cycle to unlock the flash part. 3. Bit 3 and bit 4 should NOT be both set to 1.
3	<p>Lower Write Status Required (LWSR) — R/W. This register is locked by the Vendor Component Lock (LVCL) bit.</p> <p>0 = No automatic write of 00h will be made to the SPI flash's status register) 1 = A write of 00h to the SPI flash's status register will be sent on EVERY write and erase to the SPI flash. 50h 01h 00h is the opcode sequence used to unlock the Status register.</p> <p>NOTES:</p> <ol style="list-style-type: none"> 1. This bit should not be set to 1 if there are non volatile bits in the SPI flash's status register. This may lead to premature flash wear out. 2. This is not an atomic sequence. If the SPI component's status register is non-volatile, then BIOS should issue an atomic software sequence cycle to unlock the flash part. 3. Bit 3 and bit 4 should NOT be both set to 1.
2	<p>Lower Write Granularity (LWG) — R/W. This register is locked by the Vendor Component Lock (LVCL) bit.</p> <p>0 = 1 Byte 1 = 64 Byte</p> <p>NOTES:</p> <ol style="list-style-type: none"> 1. If more than one Flash component exists, this field must be set to the lowest common write granularity of the different Flash components. 2. If using 64 B write, BIOS must ensure that multiple byte writes do not occur over 256 B boundaries. This will lead to corruption as the write will wrap around the page boundary on the SPI flash part. This is a a feature page writable SPI flash.
1:0	<p>Lower Block/Sector Erase Size (LBES)— R/W. This field identifies the erasable sector size for all Flash components.</p> <p>00 = 256 Byte 01 = 4 KB 10 = 8 KB 11 = 64 KB</p> <p>This register is locked by the Vendor Component Lock (LVCL) bit.</p> <p>Hardware takes no action based on the value of this register. The contents of this register are to be used only by software and can be read in the HSFSTS.BERASE register in both the BIOS and the GbE program registers if FLA is less than FPBA.</p>

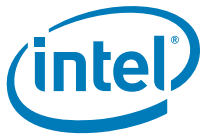

21.1.28 UVSCC— Host Upper Vendor Specific Component Capabilities Register (SPI Memory Mapped Configuration Registers)

Memory Address: SPIBAR + C8h Attribute: RO, R/WL
 Default Value: 00000000h Size: 32 bits

Note: All attributes described in UVSCC must apply to all flash space equal to or above the FPBA, even if it spans between two separate flash parts. This register is only applicable when SPI device is in descriptor mode.

Note: To prevent this register from being modified you must use LVSCC.VCL bit.

Bit	Description
31:16	Reserved
15:8	Upper Erase Opcode (UEO) — R/W. This register is programmed with the Flash erase instruction opcode required by the vendor’s Flash component. This register is locked by the Vendor Component Lock (UVCL) bit.
7:5	Reserved
4	Write Enable on Write Status (UWEWS) — R/W. This register is locked by the Vendor Component Lock (UVCL) bit. 0 = No automatic write of 00h will be made to the SPI flash’s status register) 1 = A write of 00h to the SPI flash’s status register will be sent on EVERY write and erase to the SPI flash. 06h 01h 00h is the opcode sequence used to unlock the Status register. NOTES: 1. This bit should not be set to 1 if there are non volatile bits in the SPI flash’s status register. This may lead to premature flash wear out. 2. This is not an atomic sequence. If the SPI component’s status register is non-volatile, then BIOS should issue an atomic software sequence cycle to unlock the flash part. 3. Bit 3 and bit 4 should NOT be both set to 1.
3	Upper Write Status Required (UWSR) — R/W. This register is locked by the Vendor Component Lock (UVCL) bit. 0 = No automatic write of 00h will be made to the SPI flash’s status register) 1 = A write of 00h to the SPI flash’s status register will be sent on EVERY write and erase to the SPI flash. 50h 01h 00h is the opcode sequence used to unlock the Status register. NOTES: 1. This bit should not be set to ‘1’ if there are non volatile bits in the SPI flash’s status register. This may lead to premature flash wear out. 2. This is not an atomic sequence. If the SPI component’s status register is non-volatile, then BIOS should issue an atomic software sequence cycle to unlock the flash part. 3. Bit 3 and bit 4 should NOT be both set to 1.



Bit	Description
2	<p>Upper Write Granularity (UWG) — R/W. This register is locked by the Vendor Component Lock (UVCL) bit.</p> <p>0 = 1 Byte 1 = 64 Byte</p> <p>NOTES:</p> <ol style="list-style-type: none"> 1. If more than one Flash component exists, this field must be set to the lowest common write granularity of the different Flash components. 2. If using 64 B write, BIOS must ensure that multiple byte writes do not occur over 256 B boundaries. This will lead to corruption as the write will wrap around the page boundary on the SPI flash part. This is a feature page writable SPI flash.
1:0	<p>Upper Block/Sector Erase Size (UBES)— R/W. This field identifies the erasable sector size for all Flash components.</p> <p>Valid Bit Settings:</p> <p>00 = 256 Byte 01 = 4 KB 10 = 8 KB 11 = 64 KB</p> <p>This register is locked by the Vendor Component Lock (UVCL) bit.</p> <p>Hardware takes no action based on the value of this register. The contents of this register are to be used only by software and can be read in the HSFSTS.BERASE register in both the BIOS and the GbE program registers if FLA is greater or equal to FPBA.</p>

21.1.29 FPB — Flash Partition Boundary Register (SPI Memory Mapped Configuration Registers)

Memory Address: SPIBAR + D0h Attribute: RO
Default Value: 00000000h Size: 32 bits

Note: This register is only applicable when SPI device is in descriptor mode.

Bit	Description
31:13	Reserved
12:0	Flash Partition Boundary Address (FPBA) — RO. This register reflects the value of Flash Descriptor Component FPBA field.



21.1.30 SRDL – Soft Reset Data Lock Register (SPI Memory Mapped Configuration Registers)

Memory Address: SPIBAR + F0h Attribute: R/WL
Default Value: 00000000h Size: 32 bits

Bit	Description
31:1	Reserved
0	Set_Step Lock (SSL) – R/WL. 0 = The SRDL (this register), SRDC (SPIBAR+F4h), and SRD (SPIBAR+F4h) registers are writeable. 1 = The SRDL (this register), SRDC (SPIBAR+F4h), and SRD (SPIBAR+F4h) registers are locked. NOTE: That this bit is reset to '0' on CF9h resets.

21.1.31 SRDC – Soft Reset Data Control Register (SPI Memory Mapped Configuration Registers)

Memory Address: SPIBAR + F4h Attribute: R/WL
Default Value: 00000000h Size: 32 bits

Bit	Description
31:1	Reserved
0	Soft Reset Data Select (SRDS) – R/WL. 0 = The Set_Strap data sends the default processor configuration data. 1 = The Set_Strap message bits come from the Set_Strap Msg Data register. NOTES: 1. This bit is reset by the RSMRST# or when the Resume well loses power. 2. This bit is locked by the SSL bit (SPIBAR+F0h:bit 0).

21.1.32 SRD – Soft Reset Data Register (SPI Memory Mapped Configuration Registers)

Memory Address: SPIBAR + F8h Attribute: R/WL
Default Value: 00000000h Size: 32 bits

Bit	Description
31:14	Reserved
13:0	Set_Step Data (SSD) – R/WL. NOTES: 1. These bits are reset by the RSMRST#, or when the Resume well loses power. 2. These bits are locked by the SSL bit (SPIBAR+F0h:bit 0).



21.2 Flash Descriptor Records

The following sections describe the data structure of the Flash Descriptor on the SPI device. These are not registers within the PCH.

21.3 OEM Section

Memory Address: F00h Default Value: Size: 256 Bytes

256 Bytes are reserved at the top of the Flash Descriptor for use by the OEM. The information stored by the OEM can only be written during the manufacturing process as the Flash Descriptor read/write permissions must be set to Read Only when the computer leaves the manufacturing floor. The PCH Flash controller does not read this information. FFh is suggested to reduce programming time.

21.4 GbE SPI Flash Program Registers

The GbE Flash registers are memory-mapped with a base address MBARB found in the GbE LAN register chapter Device 25: Function 0: Offset 14h. The individual registers are then accessible at MBARB + Offset as indicated in the following table.

These memory mapped registers must be accessed in byte, word, or DWord quantities.

Note: These register are only applicable when SPI flash is used in descriptor mode.

Table 21-2. Gigabit LAN SPI Flash Program Register Address Map (GbE LAN Memory Mapped Configuration Registers) (Sheet 1 of 2)

MBARB + Offset	Mnemonic	Register Name	Default	Attribute
00h-03h	GLFPR	Gigabit LAN Flash Primary Region	00000000h	RO
04h-05h	HSFS	Hardware Sequencing Flash Status	0000h	RO, R/WC, R/W
06h-07h	HSFC	Hardware Sequencing Flash Control	0000h	R/W, R/WS
08h-0Bh	FADDR	Flash Address	00000000h	R/W
0Ch-0Fh	—	Reserved	00000000h	
10h-13h	FDATA0	Flash Data 0	00000000h	R/W
14h-4Fh	—	Reserved	00000000h	
50h-53h	FRAP	Flash Region Access Permissions	00000000h	RO, R/W
54h-57h	FREG0	Flash Region 0	00000000h	RO
58h-5Bh	FREG1	Flash Region 1	00000000h	RO
5Ch-5F	FREG2	Flash Region 2	00000000h	RO
60h-63h	FREG3	Flash Region 3	00000000h	RO
64h-73h	—	Reserved for Future Flash Regions		
74h-77h	PR0	Flash Protected Range 0	00000000h	R/W
78h-7Bh	PR1	Flash Protected Range 1	00000000h	R/W
7Ch-8Fh	—	Reserved		
90h	SSFS	Software Sequencing Flash Status	00h	RO, R/WC



Table 21-2. Gigabit LAN SPI Flash Program Register Address Map (GbE LAN Memory Mapped Configuration Registers) (Sheet 2 of 2)

MBARB + Offset	Mnemonic	Register Name	Default	Attribute
91h-93h	SSFC	Software Sequencing Flash Control	000000h	R/W
94h-95h	PREOP	Prefix Opcode Configuration	0000h	R/W
96h-97h	OPTYPE	Opcode Type Configuration	0000h	R/W
98h-9Fh	OPMENU	Opcode Menu Configuration	0000000000 000000h	R/W
A0h-DFh	—	Reserved		

21.4.1 GLFPR –Gigabit LAN Flash Primary Region Register (GbE LAN Memory Mapped Configuration Registers)

Memory Address: MBARB + 00h Attribute: RO
 Default Value: 00000000h Size: 32 bits

Bit	Description
31:29	Reserved
28:16	GbE Flash Primary Region Limit (PRL) — RO. This specifies address bits 24:12 for the Primary Region Limit. The value in this register loaded from the contents in the Flash Descriptor.FLREG3.Region Limit
15:13	Reserved
12:0	GbE Flash Primary Region Base (PRB) — RO. This specifies address bits 24:12 for the Primary Region Base The value in this register is loaded from the contents in the Flash Descriptor.FLREG3.Region Base

21.4.2 HSFS—Hardware Sequencing Flash Status Register (GbE LAN Memory Mapped Configuration Registers)

Memory Address: MBARB + 04h Attribute: RO, R/WC, R/W
 Default Value: 0000h Size: 16 bits

Bit	Description
15	Flash Configuration Lock-Down (FLOCKDN) — R/W. When set to 1, those Flash Program Registers that are locked down by this FLOCKDN bit cannot be written. Once set to 1, this bit can only be cleared by a hardware reset due to a global reset or host partition reset in an Intel® ME enabled system.
14	Flash Descriptor Valid (FDV) — RO. This bit is set to a 1 if the Flash Controller read the correct Flash Descriptor Signature. If the Flash Descriptor Valid bit is not 1, software cannot use the Hardware Sequencing registers, but must use the software sequencing registers. Any attempt to use the Hardware Sequencing registers will result in the FCERR bit being set.



Bit	Description
13	Flash Descriptor Override Pin Strap Status (FDOPSS) — RO. This bit indicates the condition of the Flash Descriptor Security Override / Intel ME Debug Mode Pin-Strap. 0 = The Flash Descriptor Security Override / Intel ME Debug Mode strap is set using external pull-up on HDA_SDO 1 = No override
12:6	Reserved
5	SPI Cycle In Progress (SCIP) — RO. Hardware sets this bit when software sets the Flash Cycle Go (FGO) bit in the Hardware Sequencing Flash Control register. This bit remains set until the cycle completes on the SPI interface. Hardware automatically sets and clears this bit so that software can determine when read data is valid and/or when it is safe to begin programming the next command. Software must only program the next command when this bit is 0.
4:3	Block/Sector Erase Size (BERASE) — RO. This field identifies the erasable sector size for all Flash components. 00 = 256 Byte 01 = 4 K Byte 10 = 8 K Byte 11 = 64 K Byte If the Flash Linear Address is less than FPBA then this field reflects the value in the LVSCC.LBES register. If the Flash Linear Address is greater or equal to FPBA then this field reflects the value in the UVSCC.UBES register.
2	Access Error Log (AEL) — R/W/C. Hardware sets this bit to a 1 when an attempt was made to access the BIOS region using the direct access method or an access to the BIOS Program Registers that violated the security restrictions. This bit is simply a log of an access security violation. This bit is cleared by software writing a 1.
1	Flash Cycle Error (FCERR) — R/W/C. Hardware sets this bit to 1 when a program register access is blocked to the FLASH due to one of the protection policies or when any of the programmed cycle registers is written while a programmed access is already in progress. This bit remains asserted until cleared by software writing a 1 or until hardware reset occurs due to a global reset or host partition reset in an Intel® ME enabled system. Software must clear this bit before setting the FLASH Cycle GO bit in this register.
0	Flash Cycle Done (FDONE) — R/W/C. The PCH sets this bit to 1 when the SPI Cycle completes after software previously set the FGO bit. This bit remains asserted until cleared by software writing a 1 or hardware reset due to a global reset or host partition reset in an Intel® ME enabled system. When this bit is set and the SPI SMI# Enable bit is set, an internal signal is asserted to the SMI# generation block. Software must make sure this bit is cleared prior to enabling the SPI SMI# assertion for a new programmed access.



21.4.3 HSFC—Hardware Sequencing Flash Control Register (GbE LAN Memory Mapped Configuration Registers)

Memory Address: MBARB + 06h Attribute: R/W, R/WS
 Default Value: 0000h Size: 16 bits

Bit	Description
15:10	Reserved
9:8	Flash Data Byte Count (FDBC) — R/W. This field specifies the number of bytes to shift in or out during the data portion of the SPI cycle. The contents of this register are 0s based with 0b representing 1 byte and 11b representing 4 bytes. The number of bytes transferred is the value of this field plus 1. This field is ignored for the Block Erase command.
7:3	Reserved
2:1	FLASH Cycle (FCYCLE) — R/W. This field defines the Flash SPI cycle type generated to the FLASH when the FGO bit is set as defined below: 00 = Read (1 up to 4 bytes by setting FDBC) 01 = Reserved 10 = Write (1 up to 4 bytes by setting FDBC) 11 = Block Erase
0	Flash Cycle Go (FGO) — R/W/S. A write to this register with a 1 in this bit initiates a request to the Flash SPI Arbiter to start a cycle. This register is cleared by hardware when the cycle is granted by the SPI arbiter to run the cycle on the SPI bus. When the cycle is complete, the FDONE bit is set. Software is forbidden to write to any register in the HSFLCTL register between the FGO bit getting set and the FDONE bit being cleared. Any attempt to violate this rule will be ignored by hardware. Hardware allows other bits in this register to be programmed for the same transaction when writing this bit to 1. This saves an additional memory write. This bit always returns 0 on reads.

21.4.4 FADDR—Flash Address Register (GbE LAN Memory Mapped Configuration Registers)

Memory Address: MBARB + 08h Attribute: R/W
 Default Value: 00000000h Size: 32 bits

Bit	Description
31:25	Reserved
24:0	Flash Linear Address (FLA) — R/W. The FLA is the starting byte linear address of a SPI Read or Write cycle or an address within a Block for the Block Erase command. The Flash Linear Address must fall within a region for which BIOS has access permissions.



21.4.5 FDATA0—Flash Data 0 Register (GbE LAN Memory Mapped Configuration Registers)

Memory Address: MBARB + 10h Attribute: R/W
 Default Value: 00000000h Size: 32 bits

Bit	Description
31:0	<p>Flash Data 0 (FD0) — R/W. This field is shifted out as the SPI Data on the Master-Out Slave-In Data pin during the data portion of the SPI cycle.</p> <p>This register also shifts in the data from the Master-In Slave-Out pin into this register during the data portion of the SPI cycle.</p> <p>The data is always shifted starting with the least significant byte, msb to lsb, followed by the next least significant byte, msb to lsb, etc. Specifically, the shift order on SPI in terms of bits within this register is: 7-6-5-4-3-2-1-0-15-14-13-...8-23-22-...16-31-...24. Bit 24 is the last bit shifted out/in. There are no alignment assumptions; byte 0 always represents the value specified by the cycle address.</p> <p>Note that the data in this register may be modified by the hardware during any programmed SPI transaction. Direct Memory Reads do not modify the contents of this register.</p>

21.4.6 FRAP—Flash Regions Access Permissions Register (GbE LAN Memory Mapped Configuration Registers)

Memory Address: MBARB + 50h Attribute: RO, R/W
 Default Value: 00000808h Size: 32 bits

Bit	Description
31:28	Reserved
27:25	<p>GbE Master Write Access Grant (GMWAG) — R/W. Each bit 27:25 corresponds to Master[3:1]. GbE can grant one or more masters write access to the GbE region 3 overriding the permissions in the Flash Descriptor.</p> <p>Master[1] is Host Processor/BIOS, Master[2] is Intel® Management Engine, Master[3] is Host processor/GbE.</p> <p>The contents of this register are locked by the FLOCKDN bit.</p>
24:20	Reserved
19:17	<p>GbE Master Read Access Grant (GMRAG) — R/W. Each bit 19:17 corresponds to Master[3:1]. GbE can grant one or more masters read access to the GbE region 3 overriding the read permissions in the Flash Descriptor.</p> <p>Master[1] is Host processor/BIOS, Master[2] is Intel® Management Engine, Master[3] is GbE.</p> <p>The contents of this register are locked by the FLOCKDN bit</p>
16:12	Reserved
11:8	<p>GbE Region Write Access (GRWA) — RO. Each bit 11:8 corresponds to Regions 3:0. If the bit is set, this master can erase and write that particular region through register accesses.</p> <p>The contents of this register are that of the Flash Descriptor. Flash Master 3.Master Region Write Access OR a particular master has granted GbE write permissions in their Master Write Access Grant register OR the Flash Descriptor Security Override strap is set.</p>
7:4	Reserved
3:0	<p>GbE Region Read Access (GRRR) — RO. Each bit 3:0 corresponds to Regions 3:0. If the bit is set, this master can read that particular region through register accesses.</p> <p>The contents of this register are that of the Flash Descriptor. Flash Master 3.Master Region Write Access OR a particular master has granted GbE read permissions in their Master Read Access Grant register.</p>



21.4.7 FREG0—Flash Region 0 (Flash Descriptor) Register (GbE LAN Memory Mapped Configuration Registers)

Memory Address: MBARB + 54h Attribute: RO
Default Value: 00000000h Size: 32 bits

Bit	Description
31:29	Reserved
28:16	Region Limit (RL) — RO. This specifies address bits 24:12 for the Region 0 Limit. The value in this register is loaded from the contents in the Flash Descriptor.FLREG0.Region Limit.
15:13	Reserved
12:0	Region Base (RB) — RO. This specifies address bits 24:12 for the Region 0 Base. The value in this register is loaded from the contents in the Flash Descriptor.FLREG0.Region Base.

21.4.8 FREG1—Flash Region 1 (BIOS Descriptor) Register (GbE LAN Memory Mapped Configuration Registers)

Memory Address: MBARB + 58h Attribute: RO
Default Value: 00000000h Size: 32 bits

Bit	Description
31:29	Reserved
28:16	Region Limit (RL) — RO. This specifies address bits 24:12 for the Region 1 Limit. The value in this register is loaded from the contents in the Flash Descriptor.FLREG1.Region Limit.
15:13	Reserved
12:0	Region Base (RB) — RO. This specifies address bits 24:12 for the Region 1 Base. The value in this register is loaded from the contents in the Flash Descriptor.FLREG1.Region Base.

21.4.9 FREG2—Flash Region 2 (Intel® ME) Register (GbE LAN Memory Mapped Configuration Registers)

Memory Address: MBARB + 5Ch Attribute: RO
Default Value: 00000000h Size: 32 bits

Bit	Description
31:29	Reserved
28:16	Region Limit (RL) — RO. This specifies address bits 24:12 for the Region 2 Limit. The value in this register is loaded from the contents in the Flash Descriptor.FLREG2.Region Limit.
15:13	Reserved
12:0	Region Base (RB) — RO. This specifies address bits 24:12 for the Region 2 Base. The value in this register is loaded from the contents in the Flash Descriptor.FLREG2.Region Base.



21.4.10 FREG3—Flash Region 3 (GbE) Register (GbE LAN Memory Mapped Configuration Registers)

Memory Address: MBARB + 60h Attribute: RO
 Default Value: 00000000h Size: 32 bits

Bit	Description
31:29	Reserved
28:16	Region Limit (RL) — RO. This specifies address bits 24:12 for the Region 3 Limit. The value in this register is loaded from the contents in the Flash Descriptor.FLREG3.Region Limit.
15:13	Reserved
12:0	Region Base (RB) — RO. This specifies address bits 24:12 for the Region 3 Base. The value in this register is loaded from the contents in the Flash Descriptor.FLREG3.Region Base.

21.4.11 PR0—Protected Range 0 Register (GbE LAN Memory Mapped Configuration Registers)

Memory Address: MBARB + 74h Attribute: R/W
 Default Value: 00000000h Size: 32 bits

Note: This register can not be written when the FLOCKDN bit is set to 1.

Bit	Description
31	Write Protection Enable — R/W. When set, this bit indicates that the Base and Limit fields in this register are valid and that writes and erases directed to addresses between them (inclusive) must be blocked by hardware. The base and limit fields are ignored when this bit is cleared.
30:29	Reserved
28:16	Protected Range Limit — R/W. This field corresponds to FLA address bits 24:12 and specifies the upper limit of the protected range. Address bits 11:0 are assumed to be FFFh for the limit comparison. Any address greater than the value programmed in this field is unaffected by this protected range.
15	Read Protection Enable — R/W. When set, this bit indicates that the Base and Limit fields in this register are valid and that read directed to addresses between them (inclusive) must be blocked by hardware. The base and limit fields are ignored when this bit is cleared.
14:13	Reserved
12:0	Protected Range Base — R/W. This field corresponds to FLA address bits 24:12 and specifies the lower base of the protected range. Address bits 11:0 are assumed to be 000h for the base comparison. Any address less than the value programmed in this field is unaffected by this protected range.



21.4.12 PR1—Protected Range 1 Register (GbE LAN Memory Mapped Configuration Registers)

Memory Address: MBARB + 78h Attribute: R/W
Default Value: 00000000h Size: 32 bits

Note: This register can not be written when the FLOCKDN bit is set to 1.

Bit	Description
31	Write Protection Enable — R/W. When set, this bit indicates that the Base and Limit fields in this register are valid and that writes and erases directed to addresses between them (inclusive) must be blocked by hardware. The base and limit fields are ignored when this bit is cleared.
30:29	Reserved
28:16	Protected Range Limit — R/W. This field corresponds to FLA address bits 24:12 and specifies the upper limit of the protected range. Address bits 11:0 are assumed to be FFFh for the limit comparison. Any address greater than the value programmed in this field is unaffected by this protected range.
15	Read Protection Enable — R/W. When set, this bit indicates that the Base and Limit fields in this register are valid and that read directed to addresses between them (inclusive) must be blocked by hardware. The base and limit fields are ignored when this bit is cleared.
14:13	Reserved
12:0	Protected Range Base — R/W. This field corresponds to FLA address bits 24:12 and specifies the lower base of the protected range. Address bits 11:0 are assumed to be 000h for the base comparison. Any address less than the value programmed in this field is unaffected by this protected range.



21.4.13 SSFS—Software Sequencing Flash Status Register (GbE LAN Memory Mapped Configuration Registers)

Memory Address: MBARB + 90h Attribute: RO, R/WC
 Default Value: 00h Size: 8 bits

Note: The Software Sequencing control and status registers are reserved if the hardware sequencing control and status registers are used.

Bit	Description
7:5	Reserved
4	Access Error Log (AEL) — RO. This bit reflects the value of the Hardware Sequencing Status AEL register.
3	Flash Cycle Error (FCERR) — R/WC. Hardware sets this bit to 1 when a programmed access is blocked from running on the SPI interface due to one of the protection policies or when any of the programmed cycle registers is written while a programmed access is already in progress. This bit remains asserted until cleared by software writing a 1 or hardware reset due to a global reset or host partition reset in an Intel® ME enabled system.
2	Cycle Done Status — R/WC. The PCH sets this bit to 1 when the SPI Cycle completes (that is, SCIP bit is 0) after software sets the GO bit. This bit remains asserted until cleared by software writing a 1 or hardware reset due to a global reset or host partition reset in an Intel® ME enabled system. When this bit is set and the SPI SMI# Enable bit is set, an internal signal is asserted to the SMI# generation block. Software must make sure this bit is cleared prior to enabling the SPI SMI# assertion for a new programmed access.
1	Reserved
0	SPI Cycle In Progress (SCIP) — RO. Hardware sets this bit when software sets the SPI Cycle Go bit in the Command register. This bit remains set until the cycle completes on the SPI interface. Hardware automatically sets and clears this bit so that software can determine when read data is valid and/or when it is safe to begin programming the next command. Software must only program the next command when this bit is 0.

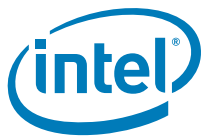

21.4.14 SSFC—Software Sequencing Flash Control Register (GbE LAN Memory Mapped Configuration Registers)

Memory Address: MBARB + 91h Attribute: R/W
 Default Value: 000000h Size: 24 bits

Bit	Description
23:19	Reserved
18:16	<p>SPI Cycle Frequency (SCF) — R/W. This register sets frequency to use for all SPI software sequencing cycles (write, erase, fast read, read status, etc.) except for the read cycle which always run at 20 MHz.</p> <p>000 = 20 MHz 001 = 33 MHz All other values = Reserved.</p> <p>This register is locked when the SPI Configuration Lock-Down bit is set.</p>
15	Reserved
14	<p>Data Cycle (DS) — R/W. When set to 1, there is data that corresponds to this transaction. When 0, no data is delivered for this cycle, and the DBC and data fields themselves are don't cares.</p>
13:8	<p>Data Byte Count (DBC) — R/W. This field specifies the number of bytes to shift in or out during the data portion of the SPI cycle. The valid settings (in decimal) are any value from 0 to 3. The number of bytes transferred is the value of this field plus 1. Note that when this field is 00b, then there is 1 byte to transfer and that 11b means there are 4 bytes to transfer.</p>
7	Reserved
6:4	<p>Cycle Opcode Pointer (COP) — R/W. This field selects one of the programmed opcodes in the Opcode Menu to be used as the SPI Command/Opcode. In the case of an Atomic Cycle Sequence, this determines the second command.</p>
3	<p>Sequence Prefix Opcode Pointer (SPOP) — R/W. This field selects one of the two programmed prefix opcodes for use when performing an Atomic Cycle Sequence. A value of 0 points to the opcode in the least significant byte of the Prefix Opcodes register. By making this programmable, the PCH supports flash devices that have different opcodes for enabling writes to the data space versus status register.</p>
2	<p>Atomic Cycle Sequence (ACS) — R/W. When set to 1 along with the SCGO assertion, the PCH will execute a sequence of commands on the SPI interface without allowing the LAN component to arbitrate and interleave cycles. The sequence is composed of:</p> <ul style="list-style-type: none"> • Atomic Sequence Prefix Command (8-bit opcode only) • Primary Command specified below by software (can include address and data) • Polling the Flash Status Register (opcode 05h) until bit 0 becomes 0b. <p>The SPI Cycle in Progress bit remains set and the Cycle Done Status bit remains unset until the Busy bit in the Flash Status Register returns 0.</p>
1	<p>SPI Cycle Go (SCGO) — R/WS. This bit always returns 0 on reads. However, a write to this register with a '1' in this bit starts the SPI cycle defined by the other bits of this register. The "SPI Cycle in Progress" (SCIP) bit gets set by this action. Hardware must ignore writes to this bit while the Cycle In Progress bit is set.</p> <p>Hardware allows other bits in this register to be programmed for the same transaction when writing this bit to 1. This saves an additional memory write.</p>
0	Reserved



21.4.15 PREOP—Prefix Opcode Configuration Register (GbE LAN Memory Mapped Configuration Registers)

Memory Address: MBARB + 94h Attribute: R/W
Default Value: 0000h Size: 16 bits

Bit	Description
15:8	Prefix Opcode 1 — R/W. Software programs an SPI opcode into this field that is permitted to run as the first command in an atomic cycle sequence.
7:0	Prefix Opcode 0 — R/W. Software programs an SPI opcode into this field that is permitted to run as the first command in an atomic cycle sequence.

NOTE: This register is not writable when the SPI Configuration Lock-Down bit (MBARB + 00h:15) is set.

21.4.16 OPTYPE—Opcode Type Configuration Register (GbE LAN Memory Mapped Configuration Registers)

Memory Address: MBARB + 96h Attribute: R/W
Default Value: 0000h Size: 16 bits

Entries in this register correspond to the entries in the Opcode Menu Configuration register.

Note: The definition below only provides write protection for opcodes that have addresses associated with them. Therefore, any erase or write opcodes that do not use an address should be avoided (for example, “Chip Erase” and “Auto-Address Increment Byte Program”).

Bit	Description
15:14	Opcode Type 7 — R/W. See the description for bits 1:0
13:12	Opcode Type 6 — R/W. See the description for bits 1:0
11:10	Opcode Type 5 — R/W. See the description for bits 1:0
9:8	Opcode Type 4 — R/W. See the description for bits 1:0
7:6	Opcode Type 3 — R/W. See the description for bits 1:0
5:4	Opcode Type 2 — R/W. See the description for bits 1:0
3:2	Opcode Type 1 — R/W. See the description for bits 1:0
1:0	<p>Opcode Type 0 — R/W. This field specifies information about the corresponding Opcode 0. This information allows the hardware to 1) know whether to use the address field and 2) provide BIOS and Shared Flash protection capabilities. The encoding of the two bits is:</p> <p>00 = No address associated with this Opcode; Read cycle type 01 = No address associated with this Opcode; Write cycle type 10 = Address required; Read cycle type 11 = Address required; Write cycle type</p>

NOTE: This register is not writable when the SPI Configuration Lock-Down bit (MBARB + 00h:15) is set.

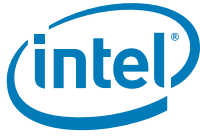

21.4.17 OPMENU—Opcode Menu Configuration Register (GbE LAN Memory Mapped Configuration Registers)

Memory Address: MBARB + 98h Attribute: R/W
Default Value: 0000000000000000h Size: 64 bits

Eight entries are available in this register to give GbE a sufficient set of commands for communicating with the flash device, while also restricting what malicious software can do. This keeps the hardware flexible enough to operate with a wide variety of SPI devices.

Note: It is recommended that GbE avoid programming Write Enable opcodes in this menu. Malicious software could then perform writes and erases to the SPI flash without using the atomic cycle mechanism. This could cause functional failures in a shared flash environment. Write Enable opcodes should only be programmed in the Prefix Opcodes.

Bit	Description
63:56	Allowable Opcode 7 — R/W. See the description for bits 7:0
55:48	Allowable Opcode 6 — R/W. See the description for bits 7:0
47:40	Allowable Opcode 5 — R/W. See the description for bits 7:0
39:32	Allowable Opcode 4 — R/W. See the description for bits 7:0
31:24	Allowable Opcode 3 — R/W. See the description for bits 7:0
23:16	Allowable Opcode 2 — R/W. See the description for bits 7:0
15:8	Allowable Opcode 1 — R/W. See the description for bits 7:0
7:0	Allowable Opcode 0 — R/W. Software programs an SPI opcode into this field for use when initiating SPI commands through the Control Register.

This register is not writable when the SPI Configuration Lock-Down bit (MBARB + 00h:15) is set.





22 Thermal Sensor Registers (D31:F6)

22.1 PCI Bus Configuration Registers

Table 22-1. Thermal Sensor Register Address Map

Offset	Mnemonic	Register Name	Default	Attribute
00h–01h	VID	Vendor Identification	8086h	RO
02h–03h	DID	Device Identification	1C24h	RO
04h–05h	CMD	Command Register	0000h	R/W, RO
06h–07h	STS	Device Status	0010h	R/WC, RO
08h	RID	Revision ID	00h	RO
09h	PI	Programming Interface	00h	RO
0Ah	SCC	Sub Class Code	80h	RO
0Bh	BCC	Base Class Code	11h	RO
0Ch	CLS	Cache Line Size	00h	RO
0Dh	LT	Latency Timer	00h	RO
0Eh	HTYPE	Header Type	00h	RO
10h–13h	TBAR	Thermal Base Address	00000004h	R/W, RO
14h–17h	TBARH	Thermal Base Address High DWord	00000000h	RO
2Ch–2Dh	SVID	Subsystem Vendor Identifier	0000h	R/WO
2Eh–2Fh	SID	Subsystem Identifier	0000h	R/WO
34h	CAP_PTR	Capabilities Pointer	50h	RO
3Ch	INTLN	Interrupt Line	00h	R/W
3Dh	INTPN	Interrupt Pin	See Description	RO
40h–43h	TBARB	BIOS Assigned Thermal Base Address	00000004h	R/W, RO
44h–47h	TBARBH	BIOS Assigned Thermal Base High DWord	00000000h	R/W
50h–51h	PID	PCI Power Management Capability ID	0001h	RO
52h–53h	PC	Power Management Capabilities	0023h	RO
54h–57h	PCS	Power Management Control and Status	0008h	R/W, RO



22.1.1 VID—Vendor Identification Register

Offset Address: 00h-01h Attribute: RO
Default Value: 8086h Size: 16 bit
Lockable: No Power Well: Core

Bit	Description
15:0	Vendor ID — RO. This is a 16-bit value assigned to Intel. Intel VID = 8086h

22.1.2 DID—Device Identification Register

Offset Address: 02h-03h Attribute: RO
Default Value: 1C24h Size: 16 bits

Bit	Description
15:0	Device ID (DID) — RO. Indicates the device number assigned by the SIG.

22.1.3 CMD—Command Register

Address Offset: 04h-05h Attribute: RO, R/W
Default Value: 0000h Size: 16 bits

Bit	Description
15:11	Reserved
10	Interrupt Disable (ID) — R/W. Enables the device to assert an INTx#. 0 = When cleared, the INTx# signal may be asserted. 1 = When set, the Thermal logic's INTx# signal will be deasserted.
9	FBE (Fast Back to Back Enable) — RO. Hardwired to 0.
8	SEN (SERR Enable) — RO. Hardwired to 0.
7	WCC (Wait Cycle Control) — RO. Hardwired to 0.
6	PER (Parity Error Response) — RO. Hardwired to 0.
5	VPS (VGA Palette Snoop) — RO. Hardwired to 0.
4	MWI (Memory Write and Invalidate Enable) — RO. Hardwired to 0.
3	SCE (Special Cycle Enable) — RO. Hardwired to 0.
2	BME (Bus Master Enable) — R/W. 0 = Function disabled as bus master. 1 = Function enabled as bus master.
1	Memory Space Enable (MSE) — R/W. 0 = Disable 1 = Enable. Enables memory space accesses to the Thermal registers.
0	IOS (I/O Space) — RO. The Thermal logic does not implement IO Space; therefore, this bit is hardwired to 0.



22.1.4 STS—Status Register

Address Offset: 06h–07h Attribute: R/WC, RO
 Default Value: 0010h Size: 16 bits

Bit	Description
15	Detected Parity Error (DPE) — R/WC. This bit is set whenever a parity error is seen on the internal interface for this function, regardless of the setting of bit 6 in the command register. Software clears this bit by writing a 1 to this bit location.
14	SERR# Status (SERRS) — RO. Hardwired to 0.
13	Received Master Abort (RMA) — RO. Hardwired to 0.
12	Received Target Abort (RTA) — RO. Hardwired to 0.
11	Signaled Target-Abort (STA) — RO. Hardwired to 0.
10:9	DEVSEL# Timing Status (DEVT) — RO. Hardwired to 0.
8	Master Data Parity Error (MDPE) — RO. Hardwired to 0.
7	Fast Back to Back Capable (FBC) — RO. Hardwired to 0.
6	Reserved
5	66 MHz Capable (C66) — RO. Hardwired to 0.
4	Capabilities List Exists (CLIST) — RO. Indicates that the controller contains a capabilities pointer list. The first item is pointed to by looking at configuration offset 34h.
3	Interrupt Status (IS) — RO. Reflects the state of the INTx# signal at the input of the enable/disable circuit. This bit is a 1 when the INTx# is asserted. This bit is a 0 after the interrupt is cleared (independent of the state of the Interrupt Disable bit in the command register).
2:0	Reserved

22.1.5 RID—Revision Identification Register

Address Offset: 08h Attribute: RO
 Default Value: 00h Size: 8 bits

Bit	Description
7:0	Revision ID (RID) — RO. Indicates the device specific revision identifier.

22.1.6 PI— Programming Interface Register

Address Offset: 09h Attribute: RO
 Default Value: 00h Size: 8 bits

Bit	Description
7:0	Programming Interface (PI) — RO. The PCH Thermal logic has no standard programming interface.



22.1.12 TBAR—Thermal Base Register

Address Offset: 10h–13h Attribute: R/W, RO
 Default Value: 00000004h Size: 32 bits

This BAR creates 4K bytes of memory space to signify the base address of Thermal memory mapped configuration registers. This memory space is active when the Command (CMD) register Memory Space Enable (MSE) bit is set and either TBAR[31:12] or TBARH are programmed to a non-zero address. This BAR is owned by the Operating System, and allows the OS to locate the Thermal registers in system memory space.

Bit	Description
31:12	Thermal Base Address (TBA) — R/W. This field provides the base address for the Thermal logic memory mapped configuration registers. 4 KB bytes are requested by hardwiring bits 11:4 to 0s.
11:4	Reserved
3	Prefetchable (PREF) — RO. Indicates that this BAR is NOT pre-fetchable.
2:1	Address Range (ADDRNG) — RO. Indicates that this BAR can be located anywhere in 64 bit address space.
0	Space Type (SPTYP) — RO. Indicates that this BAR is located in memory space.

22.1.13 TBARH—Thermal Base High DWord Register

Address Offset: 14h–17h Attribute: R/W, RO
 Default Value: 00000000h Size: 32 bits

This BAR extension holds the high 32 bits of the 64 bit TBAR. In conjunction with TBAR, it creates 4 KB of memory space to signify the base address of Thermal memory mapped configuration registers.

Bit	Description
31:0	Thermal Base Address High (TBAH) — R/W. TBAR bits 61:32.

22.1.14 SVID—Subsystem Vendor ID Register

Address Offset: 2Ch–2Dh Attribute: R/WO
 Default Value: 0000h Size: 16 bits

This register should be implemented for any function that could be instantiated more than once in a given system. The SVID register, in combination with the Subsystem ID register, enables the operating environment to distinguish one subsystem from the other(s).

Software (BIOS) will write the value to this register. After that, the value can be read, but writes to the register will have no effect. The write to this register should be combined with the write to the SID to create one 32-bit write. This register is not affected by D3_{HOT} to D0 reset.

Bit	Description
15:0	SVID (SVID) — R/WO. These R/WO bits have no PCH functionality.

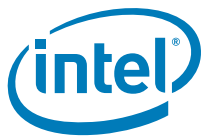

22.1.15 SID—Subsystem ID Register

Address Offset: 2Eh–2Fh Attribute: R/WO
 Default Value: 0000h Size: 16 bits

This register should be implemented for any function that could be instantiated more than once in a given system. The SID register, in combination with the Subsystem Vendor ID register make it possible for the operating environment to distinguish one subsystem from the other(s).

Software (BIOS) will write the value to this register. After that, the value can be read, but writes to the register will have no effect. The write to this register should be combined with the write to the SVID to create one 32-bit write. This register is not affected by D3_{HOT} to D0 reset.

Bit	Description
15:0	SID (SAID) — R/WO. These R/WO bits have no PCH functionality.

22.1.16 CAP_PTR—Capabilities Pointer Register

Address Offset: 34h Attribute: RO
 Default Value: 50h Size: 8 bits

Bit	Description
7:0	Capability Pointer (CP) — RO. Indicates that the first capability pointer offset is offset 50h (Power Management Capability).

22.1.17 INTLN—Interrupt Line Register

Address Offset: 3Ch Attribute: R/W
 Default Value: 00h Size: 8 bits

Bit	Description
7:0	Interrupt Line — R/W. PCH hardware does not use this field directly. It is used to communicate to software the interrupt line that the interrupt pin is connected to.

22.1.18 INTPN—Interrupt Pin Register

Address Offset: 3Dh Attribute: RO
 Default Value: See description Size: 8 bits

Bit	Description
7:4	Reserved
3:0	Interrupt Pin — RO. This reflects the value of the Device 31 interrupt pin bits 27:24 (TTIP) in chipset configuration space.



22.1.19 TBARB—BIOS Assigned Thermal Base Address Register

Address Offset: 40h–43h Attribute: R/W,RO
 Default Value: 00000004h Size: 32 bits

This BAR creates 4 KB of memory space to signify the base address of Thermal memory mapped configuration registers. This memory space is active when TBARB.SPTYPEN is asserted. This BAR is owned by the BIOS, and allows the BIOS to locate the Thermal registers in system memory space. If both TBAR and TBARB are programmed, then the OS and BIOS each have their own independent “view” of the Thermal registers, and must use the TSIU register to denote Thermal registers ownership/availability.

Bit	Description
31:12	Thermal Base Address (TBA) — R/W. This field provides the base address for the Thermal logic memory mapped configuration registers. 4K B bytes are requested by hardwiring bits 11:4 to 0s.
11:4	Reserved
3	Prefetchable (PREF) — RO. Indicates that this BAR is NOT pre-fetchable.
2:1	Address Range (ADDRNG) — RO. Indicates that this BAR can be located anywhere in 64 bit address space.
0	Space Type Enable (SPTYPEN) — R/W. 0 = Disable. 1 = Enable. When set to 1b by software, enables the decode of this memory BAR.

22.1.20 TBARBH—BIOS Assigned Thermal Base High DWord Register

Address Offset: 44h–47h Attribute: R/W
 Default Value: 00000000h Size: 32 bits

This BAR extension holds the high 32 bits of the 64 bit TBARB.

Bit	Description
31:0	Thermal Base Address High (TBAH) — R/W. TBAR bits 61:32.

22.1.21 PID—PCI Power Management Capability ID Register

Address Offset: 50h–51h Attribute: RO
 Default Value: 0001h Size: 16 bits

Bit	Description
15:8	Next Capability (NEXT) — RO. Indicates that this is the last capability structure in the list.
7:0	Cap ID (CAP) — RO. Indicates that this pointer is a PCI power management capability



22.1.22 PC—Power Management Capabilities Register

Address Offset: 52h–53h Attribute: RO
 Default Value: 0023h Size: 16 bits

Bit	Description
15:11	PME_Support — RO. Indicates PME# is not supported
10	D2_Support — RO. The D2 state is not supported.
9	D1_Support — RO. The D1 state is not supported.
8:6	Aux_Current — RO. PME# from D3COLD state is not supported, therefore this field is 000b.
5	Device Specific Initialization (DSI) — RO. Indicates that device-specific initialization is required.
4	Reserved
3	PME Clock (PMEC) — RO. Does not apply. Hardwired to 0.
2:0	Version (VS) — RO. Indicates support for Revision 1.2 of the <i>PCI Power Management Specification</i> .

22.1.23 PCS—Power Management Control And Status Register

Address Offset: 54h–57h Attribute: R/W, RO
 Default Value: 0008h Size: 32 bits

Bit	Description
31:24	Data — RO. Does not apply. Hardwired to 0s.
23	Bus Power/Clock Control Enable (BPCCE) — RO. Hardwired to 0.
22	B2/B3 Support (B23) — RO. Does not apply. Hardwired to 0.
21:16	Reserved
15	PME Status (PMES) — RO. This bit is always 0, since this PCI Function does not generate PME#.
14:9	Reserved
8	PME Enable (PMEE) — RO. This bit is always zero, since this PCI Function does not generate PME#.
7:4	Reserved
3	No Soft Reset — RO. When set 1, this bit indicates that devices transitioning from D3 _{HOT} to D0 because of PowerState commands do not perform an internal reset. Configuration context is preserved. Upon transition from D3 _{HOT} to D0 initialized state, no additional operating system intervention is required to preserve Configuration Context beyond writing the PowerState bits.
2	Reserved
1:0	Power State (PS) — R/W. This field is used both to determine the current power state of the Thermal controller and to set a new power state. The values are: 00 = D0 state 11 = D3 _{HOT} state If software attempts to write a value of 10b or 01b in to this field, the write operation must complete normally; however, the data is discarded and no state change occurs. When in the D3 _{HOT} states, the Thermal controller's configuration space is available, but the I/O and memory spaces are not. Additionally, interrupts are blocked. When software changes this value from the D3 _{HOT} state to the D0 state, no internal warm (soft) reset is generated.



22.2 Thermal Memory Mapped Configuration Registers (Thermal Sensor – D31:F26)

The base memory for these thermal memory mapped configuration registers is specified in the TBARB (D31:F6:Offset 40h). The individual registers are then accessible at TBARB + Offset.

Table 22-2. Thermal Memory Mapped Configuration Register Address Map

Offset	Mnemonic	Register Name	Default	Attribute
00h	TSIU	Thermal Sensor In Use	00h	RO,R/W
01h	TSE	Thermal Sensor Enable	00h	R/W
02h	TSS	Thermal Sensor Status	00h	R/W
03h	TSTR	Thermal Sensor Thermometer Read	FFh	RO
04h	TSSTP	Thermal Sensor Temperature Trip Point	00000000h	R/W
08h	TSCO	Thermal Sensor Catastrophic Lock Down	00h	R/W
0Ch	TSES	Thermal Sensor Error Status	00h	R/WC
0Dh	TSGPEN	Thermal Sensor General Purpose Event Enable	00h	R/W
0Eh	TSPC	Thermal Sensor Policy Control	00h	R/W, RO
14h	PTA	PCH Temperature Adjust	0000h	R/W
1Ah	TRC	Thermal Reporting Control	0000h	R/W
3Fh	AE	Alert Enable	00h	R/W
56h	PTL	Processor Temperature Limit	0000h	R/W
60h	PTV	Processor Temperature Value	0000h	RO
6Ch	TT	Thermal Throttling	00000000h	R/W
70h	PHL	PCH Hot Level	00h	R/W
82h	TSPIEN	Thermal Sensor PCI Interrupt Event enable	00h	R/W
83h	TSLOCK	Thermal Sensor Register Lock Control	00h	R/W
ACh	TC2	Thermal Compares 2	00000000h	RO
B0h	DTV	DIMM Temperature Values	00000000h	RO
D8h	ITV	Internal Temperature Values	00000000h	RO



22.2.1 TSIU—Thermal Sensor In Use Register

Offset Address: TBARB+00h Attribute: RO, R/W
Default Value: 00h Size: 8 bit

Bit	Description
7:1	Reserved
0	Thermal Sensor In Use (TSIU) — R/W. This is a SW semaphore bit. After a core well reset, a read to this bit returns a 0. After the first read, subsequent reads will return a 1. A write of a 1 to this bit will reset the next read value to 0. Writing a 0 to this bit has no effect. Software can poll this bit until it reads a 0, and will then own the usage of the thermal sensor. This bit has no other effect on the hardware, and is only used as a semaphore among various independent software threads that may need to use the thermal sensor. Software that reads this register but does not intend to claim exclusive access of the thermal sensor must write a 1 to this bit if it reads a 0, in order to allow other software threads to claim it.

22.2.2 TSE—Thermal Sensor Enable Register

Offset Address: TBARB+01h Attribute: R/W
Default Value: 00h Size: 8 bit

Bit	Description
7:0	Thermal Sensor Enable (TSE) — R/W. BIOS programs this register to enable the thermal sensor.

22.2.3 TSS—Thermal Sensor Status Register

Offset Address: TBARB+02h Attribute: RO
Default Value: 00h Size: 8 bit

Bit	Description
7	Catastrophic Trip Indicator (CTI) — RO. 0 = The temperature is below the catastrophic setting. 1 = The temperature is above the catastrophic setting.
6	Hot Trip Indicator (HTI) — RO. 0 = The temperature is below the Hot setting. 1 = The temperature is above the Hot setting.
5	Auxiliary Trip Indicator (ATI) — RO. 0 = The temperature is below the Auxiliary setting. 1 = The temperature is above the Auxiliary setting.
4	Reserved
3	Auxiliary2 Trip Indicator (ATI) — RO. 0 = The temperature is below the Auxiliary2 setting. 1 = The temperature is above the Auxiliary2 setting.
2:0	Reserved



22.2.4 TSTR—Thermal Sensor Thermometer Read Register

Offset Address: TBARB+03h Attribute: RO
 Default Value: FFh Size: 8 bit

This register generally provides the calibrated temperature from the thermometer circuit when the thermometer is enabled.

Bit	Description
7:0	Thermometer Reading (TR) — RO. Value corresponds to the thermal sensor temperature. This register has a straight binary encoding that ranges from 0 to FFh. The value in this field is valid only if the TR value is between 00h and 7Fh.

22.2.5 TSTTP—Thermal Sensor Temperature Trip Point Register

Offset Address: TBARB+04h Attribute: R/W
 Default Value: 00000000h Size: 32 bit

Bit	Description
31:24	Auxiliary2 Trip Point Setting (A2TPS) — R/W. These bits set the Auxiliary2 trip point. These bits are lockable using programming the policy-lock down bit (bit 7) of TSPC register. These bits may only be programmed from 0h to 7Fh. Setting bit 31 is illegal.
23:16	Auxiliary Trip Point Setting (ATPS) — R/W. These bits set the Auxiliary trip point. These bits are lockable using TSLOCK bit 2 These bits may only be programmed from 0h to 7Fh. Setting bit 23 is illegal.
15:8	Hot Trip Point Setting (HTPS) — R/W. These bits set the Hot trip point. These bits are lockable using programming the policy-lock down bit (bit 7) of TSPC register. These bits may only be programmed from 0h to 7Fh. Setting bit 15 is illegal. NOTE: BIOS should program to 3Ah for setting Hot Trip Point to 108 °C.
7:0	Catastrophic Trip Point Setting (CTPS) — R/W. These bits set the catastrophic trip point. These bits are lockable using TSCO.bit 7. These bits may only be programmed from 0h to 7Fh. Setting bit 7 is illegal. NOTE: BIOS should program to 2Bh for setting Catastrophic Trip Point to 120 °C.



22.2.6 TSCO—Thermal Sensor Catastrophic Lock-Down Register

Offset Address: TBARB+08h Attribute: R/W
Default Value: 00h Size: 8 bit

Bit	Description
7	Lock bit for Catastrophic (LBC) — R/W. 0 = Catastrophic programming interface is unlocked 1 = Locks the Catastrophic programming interface including TSTTP.bits[7:0]. This bit may only be set to a 0 by a host partitioned reset (note that CF9 warm reset is a host partitioned reset). Writing a 0 to this bit has no effect. TSCO.[7] is unlocked by default and can be locked through BIOS.
6:0	Reserved



22.2.7 TSES—Thermal Sensor Error Status Register

Offset Address: TBARB+0Ch
Default Value: 00h

Attribute: R/WC
Size: 8 bit

Bit	Description
7	<p>Auxiliary2 High-to-LowEvent — R/WC. 0 = No trip occurs. 1 = Indicates that an Auxiliary2 Thermal Sensor trip event occurred based on a higher to lower temperature transition through the trip point. Software must write a 1 to clear this status bit.</p>
6	<p>Catastrophic High-to-LowEvent — R/WC. 0 = No trip occurs. 1 = Indicates that a Catastrophic Thermal Sensor trip event occurred based on a higher to lower temperature transition through the trip point. 1 = Software must write a 1 to clear this status bit.</p>
5	<p>Hot High-to-LowEvent — R/WC. 0 = No trip occurs. 1 = Indicates that a Hot Thermal Sensor trip event occurred based on a higher to lower temperature transition through the trip point. Software must write a 1 to clear this status bit.</p>
4	<p>Auxiliary High-to-LowEvent — R/WC. 0 = No trip occurs. 1 = Indicates that an Auxiliary Thermal Sensor trip event occurred based on a higher to lower temperature transition through the trip point. Software must write a 1 to clear this status bit.</p>
3	<p>Auxiliary2 Low-to-High Event — R/WC. 0 = No trip occurs. 1 = Indicates that an Auxiliary2 Thermal Sensor trip event occurred based on a lower to higher temperature transition through the trip point. Software must write a 1 to clear this status bit.</p>
2	<p>Catastrophic Low-to-High Event — R/WC. 0 = No trip occurs. 1 = Indicates that a Catastrophic Thermal Sensor trip event occurred based on a lower to higher temperature transition through the trip point. Software must write a 1 to clear this status bit.</p>
1	<p>Hot Low-to-High Event — R/WC. 0 = No trip occurs. 1 = Indicates that a hot Thermal Sensor trip event occurred based on a lower to higher temperature transition through the trip point. Software must write a 1 to clear this status bit.</p>
0	<p>Auxiliary Low-to-High Event — R/WC. 0 = No trip occurs. 1 = Indicates that an Auxiliary Thermal Sensor trip event occurred based on a lower to higher temperature transition through the trip point. Software must write a 1 to clear this status bit.</p>

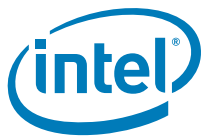

22.2.8 TSGPEN—Thermal Sensor General Purpose Event Enable Register

Offset Address: TBARB+0Dh Attribute: R/W
Default Value: 00h Size: 8 bit

This register controls the conditions that result in General Purpose events to be signalled from Thermal Sensor trip events.

Bit	Description
7	Auxiliary2 High-to-Low Enable — R/W. 0 = Corresponding status bit does not result in General Purpose event. 1 = General purpose event is signaled when the corresponding status bit is set in the Thermal Error Status Register.
6	Catastrophic High-to-Low Enable — R/W. 0 = Corresponding status bit does not result in General Purpose event. 1 = General purpose event is signaled when the corresponding status bit is set in the Thermal Error Status Register.
5	Hot High-to-Low Enable — R/W. 0 = Corresponding status bit does not result in General Purpose event. 1 = General purpose event is signaled when the corresponding status bit is set in the Thermal Error Status Register.
4	Auxiliary High-to-Low Enable — R/W. 0 = Corresponding status bit does not result in General Purpose event. 1 = General purpose event is signaled when the corresponding status bit is set in the Thermal Error Status Register.
3	Auxiliary2 Low-to-High Enable — R/W. 0 = Corresponding status bit does not result in General Purpose event. 1 = General purpose event is signaled when the corresponding status bit is set in the Thermal Error Status Register.
2	Catastrophic Low-to-High Enable — R/W. 0 = Corresponding status bit does not result in General Purpose event. 1 = General purpose event is signaled when the corresponding status bit is set in the Thermal Error Status Register.
1	Hot Low-to-High Enable — R/W. 0 = Corresponding status bit does not result in General Purpose event. 1 = General purpose event is signaled when the corresponding status bit is set in the Thermal Error Status Register.
0	Auxiliary Low-to-High Enable — R/W. 0 = Corresponding status bit does not result in General Purpose event. 1 = General purpose event is signaled when the corresponding status bit is set in the Thermal Error Status Register.



22.2.9 TSPC—Thermal Sensor Policy Control Register

Offset Address: TBARB+0Eh Attribute: R/W, RO
 Default Value: 00h Size: 8 bit

Bit	Description
7	<p>Policy Lock-Down Bit — R/W. 0 = This register can be programmed and modified. 1 = Prevents writes to this register and TSTTP.bits [31:16] (offset 04h).</p> <p>NOTE: TSCO.bit 7 (offset 08h) and TSLOCK.bit2 (offset 83h) must also be 1 when this bit is set to 1.</p> <p>This bit is reset to 0 by a host partitioned reset (note that CF9 warm reset is a host partitioned reset). Writing a 0 to this bit has no effect.</p>
6	<p>Catastrophic Power-Down Enable — R/W. When set to 1, the power management logic unconditionally transitions to the S5 state when a catastrophic temperature is detected by the sensor.</p> <p>NOTE: BIOS should set this bit to 1 to enable Catastrophic power-down.</p>
5:4	Reserved
3	<p>SMI Enable on Auxiliary2 Thermal Sensor Trip — R/W. 0 = Disables SMI# assertion for Auxiliary2 Thermal Sensor events. 1 = Enables SMI# assertions on Auxiliary2 Thermal Sensor events for either low-to-high or high-to-low events. (Both edges are enabled by this bit.)</p>
2	<p>SMI Enable on Catastrophic Thermal Sensor Trip — R/W. 0 = Disables SMI# assertion for Catastrophic Thermal Sensor events. 1 = Enables SMI# assertions on Catastrophic Thermal Sensor events for either low-to-high or high-to-low events. (Both edges are enabled by this bit.)</p>
1	<p>SMI Enable on Hot Thermal Sensor Trip — R/W. 0 = Disables SMI# assertion for Hot Thermal Sensor events. 1 = Enables SMI# assertions on Hot Thermal Sensor events for either low-to-high or high-to-low events. (Both edges are enabled by this bit.)</p>
0	<p>SMI Enable on Auxiliary Thermal Sensor Trip — R/W. 0 = Disables SMI# assertion for Auxiliary Thermal Sensor events. 1 = Enables SMI# assertions on Auxiliary Thermal Sensor events for either low-to-high or high-to-low events. (Both edges are enabled by this bit.)</p>



22.2.10 PTA—PCH Temperature Adjust Register

Offset Address: TBARB+14h Attribute: R/W
Default Value: 0000h Size: 16 bit

Bit	Description
15:8	PCH Slope — R/W. This field contains the PCH slope for calculating PCH temperature. The bits are locked by AE.bit7 (offset 3Fh). NOTE: When thermal reporting is enabled, BIOS must write DEh into this field.
7:0	Offset — R/W. This field contains the PCH offset for calculating PCH temperature. The bits are locked by AE.bit7 (offset 3Fh). NOTE: When thermal reporting is enabled, BIOS must write 87h into this field.

22.2.11 TRC—Thermal Reporting Control Register

Offset Address: TBARB+1Ah Attribute: R/W
Default Value: 0000h Size: 16 bit

Bit	Description
15:13	Reserved
12	Thermal Data Reporting Enable — R/W. 0 = Disable 1 = Enable
11:6	Reserved
5	PCH Temperature Read Enable — R/W 0 = Disables reads of the PCH temperature. 1 = Enables reads of the PCH temperature.
4	Reserved
3	DIMM4 Temperature Read Enable — R/W 0 = Disables reads of DIMM4 temperature. 1 = Enables reads of DIMM4 temperature.
2	DIMM3 Temperature Read Enable — R/W 0 = Disables reads of DIMM3 temperature. 1 = Enables reads of DIMM3 temperature.
1	DIMM2 Temperature Read Enable — R/W 0 = Disables reads of DIMM2 temperature. 1 = Enables reads of DIMM2 temperature.
0	DIMM1 Temperature Read Enable — R/W 0 = Disables reads of DIMM1 temperature. 1 = Enables reads of DIMM1 temperature.



22.2.12 AE—Alert Enable Register

Offset Address: TBARB+3Fh Attribute: R/W
 Default Value: 00h Size: 8 bit

Bit	Description
7	Lock Enable — R/W. 0 = Lock Disabled. 1 = Lock Enabled. This will lock this register (including this bit) This bit is reset by a Host Partitioned Reset. Note that CF9 warm reset is a Host Partitioned Reset.
6:5	Reserved
4	PCH Alert Enable — R/W. When this bit is set, it will assert the PCH's TEMP_ALERT# pin if the PCH temperature is outside the temperature limits. This bit is lockable by bit 7 in this register.
3	DIMM Alert Enable — R/W. When this bit is set, it will assert the PCH's TEMP_ALERT# pin if DIMM1-4 temperature is outside of the temperature limits. Note that the actual DIMMs that are read and used for the alert are enabled in the TRC register (offset 1Ah). This bit is lockable by bit 7 in this register. NOTE: Same Upper and Lower limits for triggering TEMP_ALERT# are used for all enabled DIMMs in the system.
2:0	Reserved

22.2.13 PTL—Processor Temperature Limit Register

Offset Address: TBARB+56h Attribute: R/W
 Default Value: 0000h Size: 16 bit

Bit	Description
15:0	Processor Temperature Limit — R/W. These bits are programmed by BIOS.

22.2.14 PTV — Processor Temperature Value Register

Offset Address: TBARB+60h Attribute: RO
 Default Value: 0000h Size: 16 bit

Bit	Description
15:8	Reserved
7:0	Processor Temperature Value — RO. These bits contain the processor package temperature



22.2.15 TT—Thermal Throttling Register

Offset Address: TBARB+6Ch Attribute: R/W
Default Value: 00000000h Size: 32 bit
BIOS must program this field to 05161B20h.

Bit	Description
31:27	Reserved
26	Thermal Throttle Lock Bit — R/W. When set to '1', the Thermal Throttle (TT) register is locked and remains locked until the next platform reset.
25	Reserved
24	Thermal Throttling Enable — R/W. When set to '1', PCH thermal throttling is enabled. At reset, BIOS must set the T-state trip points defined by bits [23:0], followed by a separate write to enable this feature. If software wishes to change the trip point values, this bit must be cleared before the values in [23:0] are changed. When the new values have been entered, this bit must be set to re-enable the feature.
23:16	T3 Trip Point Temperature — R/W. When the temperature reading of Thermal Sensor Thermometer Read (TSTR) is less than or equal to this temperature, the system is in T3 state. (Note that the TSTR reading of 00h is the hottest temperature and 7Fh is the lowest temperature.)
15:8	T2 Trip Point Temperature — R/W. When the temperature reading of Thermal Sensor Thermometer Read (TSTR) is less than or equal to this temperature, the system is in T2 state. (Note that the TSTR reading of 00h is the hottest temperature and 7Fh is the lowest temperature.)
7:0	T1 Trip Point Temperature — R/W. When the temperature reading of Thermal Sensor Thermometer Read (TSTR) is less than this temperature, the system is in T1 state. If TSTR is greater than this, the system is in T0 state where no thermal throttling occurs. (Note that the TSTR reading of 00h is the hottest temperature and 7Fh is the lowest temperature.)

22.2.16 PHL—PCH Hot Level Register

Offset Address: TBARB+70h Attribute: R/W
Default Value: 00h Size: 8 bit

Bit	Description
7:0	PCH Hot Level (PHL) — R/W. When temperature reading in Thermal Sensor Thermometer Read (TSTR) is less than PHL programmed here, this will assert PCHHOT# (active low). (Note that TSTR reading of 00h is the hottest temperature and 7Fh is the lowest temperature.) Default state for this register is PHL disabled (00h). For utilizing the PCHHOT# functionality, a soft strap has to be configured and BIOS programs this PHL value. Please refer to the <i>SPI Flash Programming Guide Application Note</i> and Intel ME FW collaterals for information on enabling PCHHOT#.



22.2.17 TSPIEN—Thermal Sensor PCI Interrupt Enable Register

Offset Address: TBARB+82h Attribute: R/W
 Default Value: 00h Size: 8 bit

This register controls the conditions that result in PCI interrupts to be signalled from Thermal Sensor trip events. Software (device driver) needs to ensure that it can support PCI interrupts, even though BIOS may enable PCI interrupt capability through this register.

Bit	Description
7	Auxiliary2 High-to-Low Enable — R/W. 0 = Corresponding status bit does not result in PCI interrupt. 1 = PCI interrupt is signaled when the corresponding status bit is set in the Thermal Error Status Register.
6	Catastrophic High-to-Low Enable — R/W. 0 = Corresponding status bit does not result in PCI interrupt. 1 = PCI interrupt is signaled when the corresponding status bit is set in the Thermal Error Status Register.
5	Hot High-to-Low Enable — R/W. 0 = Corresponding status bit does not result in PCI interrupt. 1 = PCI interrupt is signaled when the corresponding status bit is set in the Thermal Error Status Register.
4	Auxiliary High-to-Low Enable — R/W. 0 = Corresponding status bit does not result in PCI interrupt. 1 = PCI interrupt is signaled when the corresponding status bit is set in the Thermal Error Status Register.
3	Auxiliary2 Low-to-High Enable — R/W. 0 = Corresponding status bit does not result in PCI interrupt. 1 = PCI interrupt is signaled when the corresponding status bit is set in the Thermal Error Status Register.
2	Catastrophic Low-to-High Enable — R/W. 0 = Corresponding status bit does not result in PCI interrupt. 1 = PCI interrupt is signaled when the corresponding status bit is set in the Thermal Error Status Register.
1	Hot Low-to-High Enable — R/W. 0 = Corresponding status bit does not result in PCI interrupt. 1 = PCI interrupt is signaled when the corresponding status bit is set in the Thermal Error Status Register.
0	Auxiliary Low-to-High Enable — R/W. 0 = Corresponding status bit does not result in PCI interrupt. 1 = PCI interrupt is signaled when the corresponding status bit is set in the Thermal Error Status Register.



22.2.18 TSLOCK—Thermal Sensor Register Lock Control Register

Offset Address: TBARB+83h Attribute: R/W
Default Value: 00h Size: 8 bit

Bit	Description
7:3	Reserved
2	Lock Control — R/W. This bit can only be set to a 0 by a host-partitioned reset. Writing a 0 to this bit has no effect. NOTE: CF9 warm reset is a host-partitioned reset.
1:0	Reserved

22.2.19 TC2—Thermal Compares 2 Register

Offset Address: TBARB+ACH Attribute: RO
Default Value: 00000000h Size: 32 bit

Bits [31:16] of this register are set when an external controller (such as EC) does the Write DIMM Temp Limits Command. Refer to [Section 5.21.3](#) for more information.

Bits [15:0] of this register are set when an external controller (such as EC) does the Write PCH Temp Limits Command. Refer to [Section 5.21.3](#) for more information.

Bit	Description
31:24	DIMM Thermal Compare Upper Limit — RO. This is the upper limit used to compare against the DIMM's temperature. If the DIMM's temperature is greater than this value, then the PCH's TEMP_ALERT# signal is asserted if enabled.
23:16	DIMM Thermal Compare Lower Limit — RO. This is the lower limit used to compare against the DIMM's temperature. If the DIMM's temperature is lower than this value, then the PCH's TEMP_ALERT# signal is asserted if enabled.
15:8	PCH Thermal Compare Upper Limit — RO. This is the upper limit used to compare against the PCH temperature. If the PCH temperature is greater than this value, then the PCH's TEMP_ALERT# signal is asserted if enabled.
7:0	PCH Thermal Compare Lower Limit — RO. This is the lower limit used to compare against the PCH temperature. If the PCH temperature is lower than this value, then the PCH's TEMP_ALERT# signal is asserted if enabled.



22.2.20 DTV—DIMM Temperature Values Register

Offset Address: TBARB+B0h Attribute: RO
 Default Value: 00000000h Size: 32 bit

Bit	Description
31:24	DIMM3 Temperature — RO. The bits contain DIMM3 temperature data in absolute degrees Celsius. These bits are data byte 8 provided to the external controller when it does a read over SMLink1. Refer to Section 5.21.3 for more details
23:16	DIMM2 Temperature — RO. The bits contain DIMM2 temperature data in absolute degrees Celsius. These bits are data byte 7 provided to the external controller when it does a read over SMLink1. Refer to Section 5.21.3 for more details
15:8	DIMM1 Temperature — RO. The bits contain DIMM1 temperature data in absolute degrees Celsius. These bits are data byte 6 provided to the external controller when it does a read over SMLink1. Refer to Section 5.21.3 for more details
7:0	DIMM0 Temperature — RO. The bits contain DIMM0 temperature data in absolute degrees Celsius. These bits are data byte 5 provided to the external controller when it does a read over SMLink1. Refer to Section 5.21.3 for more details

22.2.21 ITV—Internal Temperature Values Register

Offset Address: TBARB+D8h Attribute: RO
 Default Value: 00000000h Size: 32 bit

Bit	Description
31:24	Reserved
23:16	Sequence Number — RO. Provides a sequence number which can be used by the host to detect if the ME FW has hung. The value will roll over to 00h from FFh. The count is updated at approximately 200 ms. Host SW can check this value and if it is not incriminated over a second or so, software should assume that the ME FW is hung. NOTE: if the ME is reset, then this value will not change during the reset. After the reset is done, which may take up to 30 seconds, the ME may be on again and this value will start incrementing, indicating that the thermal values are valid again. These bits are data byte 9 provided to the external controller when it does a read over SMLink1. Refer to Section 5.21.3 for more details
15:8	Reserved
7:0	PCH Temperature — RO. The bits contain PCH temperature data in absolute degrees Celsius. These bits are data byte 1 provided to the external controller when it does a read over SMLink1. Refer to Section 5.21.3 for more details



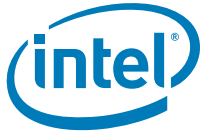



23 Intel® Management Engine Subsystem Registers (D22:F[3:0])

23.1 First Intel® Management Engine Interface (Intel® MEI) Configuration Registers (Intel® MEI 1 – D22:F0)

23.1.1 PCI Configuration Registers (Intel® MEI 1–D22:F0)

Table 23-1. Intel® MEI 1 Configuration Registers Address Map (Intel® MEI 1–D22:F0) (Sheet 1 of 2)

Offset	Mnemonic	Register Name	Default	Attribute
00h–01h	VID	Vendor Identification	8086h	RO
02h–03h	DID	Device Identification	See register description	RO
04h–05h	PCICMD	PCI Command	0000h	R/W, RO
06h–07h	PCISTS	PCI Status	0010h	RO
08h	RID	Revision Identification	See register description	RO
09h–0Bh	CC	Class Code	0C8000h	RO
0Eh	HTYPE	Header Type	00h	RO
10h–17h	MEI0_MBAR	MEI0 MMIO Base Address	00000000 0000004h	R/W, RO
2Ch–2Dh	SVID	Subsystem Vendor ID	0000h	R/WO
2Eh–2Fh	SID	Subsystem ID	0000h	R/WO
34h	CAPP	Capabilities List Pointer	50h	RO
3Ch–3Dh	INTR	Interrupt Information	0400h	R/W, RO
40h–43h	HFS	Host Firmware Status	00000000h	RO
44h–47h	ME_UMA	Management Engine UMA Register	00000000h	RO
48h–4Bh	GMES	General Intel ME Status	00000000h	RO
4Ch–4Fh	H_GS	Host General Status	00000000h	RO
50h–51h	PID	PCI Power Management Capability ID	6001h	RO
52h–53h	PC	PCI Power Management Capabilities	C803h	RO
54h–55h	PMCS	PCI Power Management Control and Status	0008h	R/WC, R/W, RO
8Ch–8Dh	MID	Message Signaled Interrupt Identifiers	0005h	RO
8Eh–8Fh	MC	Message Signaled Interrupt Message Control	0080h	R/W, RO

**Table 23-1. Intel® MEI 1 Configuration Registers Address Map (Intel® MEI 1—D22:F0) (Sheet 2 of 2)**

Offset	Mnemonic	Register Name	Default	Attribute
90h–93h	MA	Message Signaled Interrupt Message Address	00000000h	R/W, RO
94h–97h	MUA	Message Signaled Interrupt Upper Address	00000000h	R/W
98h–99h	MD	Message Signaled Interrupt Message Data	0000h	R/W
A0h	HIDM	Intel MEI Interrupt Delivery Mode	00h	R/W
BCh–BFh	HERES	Intel MEI Extended Register Status	40000000h	RO
C0h–DFh	HER[1:8]	Intel MEI Extended Register DW[1:8]	00000000h	RO

23.1.1.1 VID—Vendor Identification Register (Intel® MEI 1—D22:F0)

Address Offset: 00h–01h Attribute: RO
Default Value: 8086h Size: 16 bits

Bit	Description
15:0	Vendor ID (VID) — RO. This is a 16-bit value assigned to Intel.

23.1.1.2 DID—Device Identification Register (Intel® MEI 1—D22:F0)

Address Offset: 02h–03h Attribute: RO
Default Value: See bit description Size: 16 bits

Bit	Description
15:0	Device ID (DID) — RO. This is a 16-bit value assigned to the Intel Management Engine Interface controller. See the <i>Intel® 6 Series Chipset and Intel® C200 Series Chipset Specification Update</i> for the value of the DID Register.



23.1.1.3 PCICMD—PCI Command Register (Intel® MEI 1—D22:F0)

Address Offset: 04h–05h Attribute: R/W, RO
Default Value: 0000h Size: 16 bits

Bit	Description
15:11	Reserved
10	Interrupt Disable (ID) — R/W. Disables this device from generating PCI line based interrupts. This bit does not have any effect on MSI operation.
9:3	Reserved
2	<p>Bus Master Enable (BME)— R/W.</p> <p>Controls the Intel MEI host controller's ability to act as a system memory master for data transfers. When this bit is cleared, Intel ME bus master activity stops and any active DMA engines return to an idle condition. This bit is made visible to firmware through the H_PCI_CSR register, and changes to this bit may be configured by the H_PCI_CSR register to generate an Intel ME MSI. When this bit is 0, Intel MEI is blocked from generating MSI to the host processor.</p> <p>NOTE: This bit does not block Intel MEI accesses to Intel ME UMA; that is, writes or reads to the host and Intel ME circular buffers through the read window and write window registers still cause Intel ME backbone transactions to Intel ME UMA.</p>
1	<p>Memory Space Enable (MSE) — R/W. Controls access to the Intel ME's memory mapped register space.</p> <p>0 = Disable. Memory cycles within the range specified by the memory base and limit registers are master aborted.</p> <p>1 = Enable. Allows memory cycles within the range specified by the memory base and limit registers accepted.</p>
0	Reserved

23.1.1.4 PCISTS—PCI Status Register (Intel® MEI 1—D22:F0)

Address Offset: 06h–07h Attribute: RO
Default Value: 0010h Size: 16 bits

Bit	Description
15:5	Reserved
4	Capabilities List (CL) — RO. Indicates the presence of a capabilities list, hardwired to 1.
3	<p>Interrupt Status (IS) — RO. Indicates the interrupt status of the device.</p> <p>0 = Interrupt is deasserted.</p> <p>1 = Interrupt is asserted.</p>
2:0	Reserved

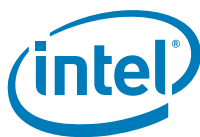

23.1.1.5 RID—Revision Identification Register (Intel® MEI 1—D22:F0)

Offset Address: 08h Attribute: RO
 Default Value: See bit description Size: 8 bits

Bit	Description
7:0	Revision ID — RO. See the <i>Intel® 6 Series Chipset and Intel® C200 Series Chipset Specification Update</i> for the value of the RID Register.

23.1.1.6 CC—Class Code Register (Intel® MEI 1—D22:F0)

Address Offset: 09h-0Bh Attribute: RO
 Default Value: 078000h Size: 24 bits

Bit	Description
23:16	Base Class Code (BCC) — RO. Indicates the base class code of the Intel MEI device.
15:8	Sub Class Code (SCC) — RO. Indicates the sub class code of the Intel MEI device.
7:0	Programming Interface (PI) — RO. Indicates the programming interface of the Intel MEI device.

23.1.1.7 HTYPE—Header Type Register (Intel® MEI 1—D22:F0)

Address Offset: 0Eh Attribute: RO
 Default Value: 80h Size: 8 bits

Bit	Description
7	Multi-Function Device (MFD) — RO. Indicates the Intel MEI host controller is part of a multifunction device.
6:0	Header Layout (HL) — RO. Indicates that the Intel MEI uses a target device layout.

23.1.1.8 MEI0_MBAR—MEI0 MMIO Base Address Register (Intel® MEI 1—D22:F0)

Address Offset: 10h-17h Attribute: R/W, RO
 Default Value: 0000000000000004h Size: 64 bits

This register allocates space for the MEI0 memory mapped registers.

Bit	Description
63:4	Base Address (BA) — R/W. Software programs this field with the base address of this region.
3	Prefetchable Memory (PM) — RO. Indicates that this range is not pre-fetchable.
2:1	Type (TP) — RO. Set to 10b to indicate that this range can be mapped anywhere in 64-bit address space.
0	Resource Type Indicator (RTE) — RO. Indicates a request for register memory space.



23.1.1.15 GMES—General Intel® ME Status Register (Intel® MEI 1—D22:F0)

Address Offset: 48h–4Bh Attribute: RO
Default Value: 00000000h Size: 32 bits

Bit	Description
31:0	General Intel ME Status (ME_GS) — RO. This field is populated by Intel ME.

23.1.1.16 H_GS—Host General Status Register (Intel® MEI 1—D22:F0)

Address Offset: 4Ch–4Fh Attribute: RO
Default Value: 00000000h Size: 32 bits

Bit	Description
31:0	Host General Status(H_GS) — RO. General Status of Host, this field is not used by Hardware

23.1.1.17 PID—PCI Power Management Capability ID Register (Intel® MEI 1—D22:F0)

Address Offset: 50h–51h Attribute: RO
Default Value: 6001h Size: 16 bits

Bit	Description
15:8	Next Capability (NEXT) — RO. Value of 60h indicates the location of the next pointer.
7:0	Capability ID (CID) — RO. Indicates the linked list item is a PCI Power Management Register.

23.1.1.18 PC—PCI Power Management Capabilities Register (Intel® MEI 1—D22:F0)

Address Offset: 52h–53h Attribute: RO
Default Value: C803h Size: 16 bits

Bit	Description
15:11	PME_Support (PSUP) — RO. This five-bit field indicates the power states in which the function may assert PME#. Intel MEI can assert PME# from any D-state except D1 or D2 which are not supported by Intel MEI.
10:9	Reserved
8:6	Aux_Current (AC) — RO. Reports the maximum Suspend well current required when in the D3 _{cold} state. Value of 00b is reported.
5	Device Specific Initialization (DSI) — RO. Indicates whether device-specific initialization is required.
4	Reserved
3	PME Clock (PMEC) — RO. Indicates that PCI clock is not required to generate PME#.
2:0	Version (VS) — RO. Hardwired to 011b to indicate support for <i>Revision 1.2 of the PCI Power Management Specification</i> .

**23.1.1.19 PMCS—PCI Power Management Control and Status Register (Intel® MEI 1—D22:F0)**

Address Offset: 54h–55h Attribute: R/WC, R/W, RO
 Default Value: 0008h Size: 16 bits

Bit	Description
15	PME Status (PMES) — R/WC. Bit is set by Intel ME Firmware. Host software clears bit by writing `1` to bit. This bit is reset when CL_RST1# asserted.
14:9	Reserved
8	PME Enable (PMEE) — R/W. This bit is read/write and is under the control of host SW. It does not directly have an effect on PME events. However, this bit is shadowed so Intel ME FW can monitor it. Intel ME FW will not cause the PMES bit to transition to 1 while the PMEE bit is 0, indicating that host SW had disabled PME. This bit is reset when PLTRST# asserted.
7:4	Reserved
3	No_Soft_Reset (NSR) — RO. This bit indicates that when the Intel MEI host controller is transitioning from D3 _{hot} to D0 due to a power state command, it does not perform an internal reset. Configuration context is preserved.
2	Reserved
1:0	Power State (PS) — R/W. This field is used both to determine the current power state of the Intel MEI host controller and to set a new power state. The values are: 00 = D0 state (default) 11 = D3 _{hot} state The D1 and D2 states are not supported for the Intel MEI host controller. When in the D3 _{hot} state, the Intel ME's configuration space is available, but the register memory spaces are not. Additionally, interrupts are blocked.

23.1.1.20 MID—Message Signaled Interrupt Identifiers Register (Intel® MEI 1—D22:F0)

Address Offset: 8Ch–8Dh Attribute: RO
 Default Value: 0005h Size: 16 bits

Bit	Description
15:8	Next Pointer (NEXT) — RO. Value of 00h indicates that this is the last item in the list.
7:0	Capability ID (CID) — RO. Capabilities ID indicates MSI.

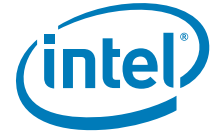

23.1.1.27 HERX—Intel® MEI Extend Register DWX (Intel® MEI 1—D22:F0)

Address Offset:	HER1: C0h–C3h HER2: C4h–C7h HER3: C8h–CBh HER4: CCh–CFh HER5: D0h–D3h HER6: D4h–D7h HER7: D8h–DBh HER8: DCh–DFh	Attribute:	RO
Default Value:	00000000h	Size:	32 bits

Bit	Description
31:0	Extend Register DWX (ERDWX). Nth DWORD result of the extend operation. NOTE: Extend Operation is HER[5:1] if using SHA-1. If using SHA-2 then Extend Operation is HER[8:1]

23.1.2 MEIO_MBAR—Intel® MEI 1 MMIO Registers

These MMIO registers are accessible starting at the Intel MEI 1 MMIO Base Address (MEIO_MBAR) which gets programmed into D22:F0:Offset 10–17h. These registers are reset by PLTRST# unless otherwise noted.

Table 23-2. Intel® MEI 1 MMIO Register Address Map

MEIO_MBAR+ Offset	Mnemonic	Register Name	Default	Attribute
00–03h	H_CB_WW	Host Circular Buffer Write Window	00000000h	RO
04h–07h	H_CSR	Host Control Status	02000000h	RO, R/W, R/WC
08h–0Bh	ME_CB_RW	Intel ME Circular Buffer Read Window	00000000h	RO
0Ch–0Fh	ME_CSR_HA	Intel ME Control Status Host Access	02000000h	RO

23.1.2.1 H_CB_WW—Host Circular Buffer Write Window Register (Intel® MEI 1 MMIO Register)

Address Offset:	MEIO_MBAR + 00h	Attribute:	RO
Default Value:	00000000h	Size:	32 bits

Bit	Description
31:0	Host Circular Buffer Write Window Field (H_CB_WWF). This bit field is for host to write into its circular buffer. The host's circular buffer is located at the Intel ME subsystem address specified in the Host CB Base Address register. This field is write only, reads will return arbitrary data. Writes to this register will increment the H_CBWP as long as ME_RDY is 1. When ME_RDY is 0, writes to this register have no effect and are not delivered to the H_CB, nor is H_CBWP incremented.

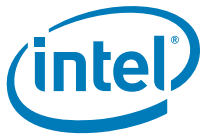

23.1.2.2 H_CSR—Host Control Status Register (Intel® MEI 1 MMIO Register)

Address Offset: MEIO_MBAR + 04h Attribute: RO, R/W, R/WC
 Default Value: 02000000h Size: 32 bits

Bit	Description
31:24	Host Circular Buffer Depth (H_CBD) — RO. This field indicates the maximum number of 32 bit entries available in the host circular buffer (H_CB). Host software uses this field along with the H_CBRP and H_CBWP fields to calculate the number of valid entries in the H_CB to read or # of entries available for write. This field is implemented with a "1-hot" scheme. Only one bit will be set to a "1" at a time. Each bit position represents the value n of a buffer depth of (2^n). For example, when bit# 1 is 1, the buffer depth is 2; when bit#2 is 1, the buffer depth is 4, etc. The allowed buffer depth values are 2, 4, 8, 16, 32, 64 and 128.
23:16	Host CB Write Pointer (H_CBWP) — RO. Points to next location in the H_CB for host to write the data. Software uses this field along with H_CBRP and H_CBD fields to calculate the number of valid entries in the H_CB to read or number of entries available for write.
15:8	Host CB Read Pointer (H_CBRP) — RO. Points to next location in the H_CB where a valid data is available for embedded controller to read. Software uses this field along with H_CBWP and H_CBD fields to calculate the number of valid entries in the host CB to read or number of entries available for write.
7:5	Reserved NOTE: For writes to this register, these bits shall be written as 000b.
4	Host Reset (H_RST) — R/W. Setting this bit to 1 will initiate a Intel MEI reset sequence to get the circular buffers into a known good state for host and Intel ME communication. When this bit transitions from 0 to 1, hardware will clear the H_RDY and ME_RDY bits.
3	Host Ready (H_RDY) — R/W. This bit indicates that the host is ready to process messages.
2	Host Interrupt Generate (H_IG) — R/W. Once message(s) are written into its CB, the host sets this bit to one for the HW to set the ME_IS bit in the ME_CSR and to generate an interrupt message to Intel ME. HW will send the interrupt message to Intel ME only if the ME_IE is enabled. HW then clears this bit to 0.
1	Host Interrupt Status (H_IS) — R/WC. Hardware sets this bit to 1 when ME_IG bit is set to 1. Host clears this bit to 0 by writing a 1 to this bit position. H_IE has no effect on this bit.
0	Host Interrupt Enable (H_IE) — R/W. Host sets this bit to 1 to enable the host interrupt (INTR# or MSI) to be asserted when H_IS is set to 1.



23.1.2.3 ME_CB_RW—Intel® ME Circular Buffer Read Window Register (Intel® MEI 1 MMIO Register)

Address Offset: MEIO_MBAR + 08h Attribute: RO
 Default Value: FFFFFFFFh Size: 32 bits

Bit	Description
31:0	Intel ME Circular Buffer Read Window Field (ME_CB_RWF). This bit field is for host to read from the Intel ME Circular Buffer. The Intel ME's circular buffer is located at the Intel ME subsystem address specified in the Intel ME CB Base Address register. This field is read only, writes have no effect. Reads to this register will increment the ME_CBRP as long as ME_RDY is 1. When ME_RDY is 0, reads to this register have no effect, all 1s are returned, and ME_CBRP is not incremented.

23.1.2.4 ME_CSR_HA—Intel® ME Control Status Host Access Register (Intel® MEI 1 MMIO Register)

Address Offset: MEIO_MBAR + 0Ch Attribute: RO
 Default Value: 02000000h Size: 32 bits

Bit	Description
31:24	Intel ME Circular Buffer Depth Host Read Access (ME_CBD_HRA). Host read only access to ME_CBD.
23:16	Intel ME CB Write Pointer Host Read Access (ME_CBWP_HRA). Host read only access to ME_CBWP.
15:8	Intel ME CB Read Pointer Host Read Access (ME_CBRP_HRA). Host read only access to ME_CBRP.
7:5	Reserved
4	Intel ME Reset Host Read Access (ME_RST_HRA). Host read access to ME_RST.
3	Intel ME Ready Host Read Access (ME_RDY_HRA): Host read access to ME_RDY.
2	Intel ME Interrupt Generate Host Read Access (ME_IG_HRA). Host read only access to ME_IG.
1	Intel ME Interrupt Status Host Read Access (ME_IS_HRA). Host read only access to ME_IS.
0	Intel ME Interrupt Enable Host Read Access (ME_IE_HRA). Host read only access to ME_IE.



23.2 Second Intel® Management Engine Interface (Intel® MEI 2) Configuration Registers (Intel® MEI 2—D22:F1)

23.2.1 PCI Configuration Registers (Intel® MEI 2—D22:F2)

Table 23-3. Intel® MEI 2 Configuration Registers Address Map (Intel® MEI 2—D22:F1) (Sheet 1 of 2)

Offset	Mnemonic	Register Name	Default	Attribute
00h–01h	VID	Vendor Identification	8086h	RO
02h–03h	DID	Device Identification	See register description	RO
04h–05h	PCICMD	PCI Command	0000h	R/W, RO
06h–07h	PCISTS	PCI Status	0010h	RO
08h	RID	Revision Identification	See register description	RO
09h–0Bh	CC	Class Code	0C8000h	RO
0Eh	HTYPE	Header Type	00h	RO
10h–17h	MEI_MBAR	MEI0 MMIO Base Address	0000000000 00004h	R/W, RO
2Ch–2Dh	SVID	Subsystem Vendor ID	0000h	R/WO
2Eh–2Fh	SID	Subsystem ID	0000h	R/WO
34h	CAPP	Capabilities List Pointer	50h	RO
3Ch–3Dh	INTR	Interrupt Information	0000h	R/W, RO
40h–43h	HFS	Host Firmware Status	00000000h	RO
48h–4Bh	GMES	General Intel ME Status	00000000h	RO
4Ch–4Fh	H_GS	Host General Status	00000000h	RO
50h–51h	PID	PCI Power Management Capability ID	6001h	RO
52h–53h	PC	PCI Power Management Capabilities	C803h	RO
54h–55h	PMCS	PCI Power Management Control and Status	0008h	R/WC, R/W, RO
8Ch–8Dh	MID	Message Signaled Interrupt Identifiers	0005h	RO
8Eh–8Fh	MC	Message Signaled Interrupt Message Control	0080h	R/W, RO
90h–93h	MA	Message Signaled Interrupt Message Address	00000000h	R/W, RO
94h–97h	MUA	Message Signaled Interrupt Upper Address	00000000h	R/W
98h–99h	MD	Message Signaled Interrupt Message Data	0000h	R/W

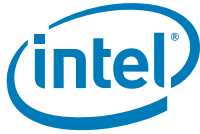
**23.2.1.3 PCICMD—PCI Command Register (Intel® MEI 2—D22:F1)**Address Offset: 04h–05h
Default Value: 0000hAttribute: R/W, RO
Size: 16 bits

Bit	Description
15:11	Reserved
10	Interrupt Disable (ID) — R/W. Disables this device from generating PCI line based interrupts. This bit does not have any effect on MSI operation.
9:3	Reserved
2	Bus Master Enable (BME) — R/W. Controls the Intel MEI host controller's ability to act as a system memory master for data transfers. When this bit is cleared, Intel MEI bus master activity stops and any active DMA engines return to an idle condition. This bit is made visible to firmware through the H_PCI_CSR register, and changes to this bit may be configured by the H_PCI_CSR register to generate an Intel ME MSI. When this bit is 0, Intel MEI is blocked from generating MSI to the host processor. NOTE: This bit does not block Intel MEI accesses to Intel ME UMA; that is, writes or reads to the host and Intel ME circular buffers through the read window and write window registers still cause Intel ME backbone transactions to Intel ME UMA.
1	Memory Space Enable (MSE) — R/W. Controls access to the Intel ME's memory mapped register space. 0 = Disable. Memory cycles within the range specified by the memory base and limit registers are master aborted. 1 = Enable. Allows memory cycles within the range specified by the memory base and limit registers accepted.
0	Reserved

23.2.1.4 PCISTS—PCI Status Register (Intel® MEI 2—D22:F1)Address Offset: 06h–07h
Default Value: 0010hAttribute: RO
Size: 16 bits

Bit	Description
15:5	Reserved
4	Capabilities List (CL) — RO. Indicates the presence of a capabilities list, hardwired to 1.
3	Interrupt Status — RO. Indicates the interrupt status of the device. 0 = Interrupt is deasserted. 1 = Interrupt is asserted.
2:0	Reserved



23.2.1.9 SVID—Subsystem Vendor ID Register (Intel® MEI 2—D22:F1)

Address Offset: 2Ch–2Dh Attribute: R/WO
Default Value: 0000h Size: 16 bits

Bit	Description
15:0	Subsystem Vendor ID (SSVID) — R/WO. Indicates the sub-system vendor identifier. This field should be programmed by BIOS during boot-up. Once written, this register becomes Read Only. This field can only be cleared by PLTRST#. NOTE: Register must be written as a Word write or as a DWord write with SID register.

23.2.1.10 SID—Subsystem ID Register (Intel® MEI 2—D22:F1)

Address Offset: 2Eh–2Fh Attribute: R/WO
Default Value: 0000h Size: 16 bits

Bit	Description
15:0	Subsystem ID (SSID) — R/WO. Indicates the sub-system identifier. This field should be programmed by BIOS during boot-up. Once written, this register becomes Read Only. This field can only be cleared by PLTRST#. NOTE: Register must be written as a Word write or as a DWord write with SVID register.

23.2.1.11 CAPP—Capabilities List Pointer Register (Intel® MEI 2—D22:F1)

Address Offset: 34h Attribute: RO
Default Value: 50h Size: 8 bits

Bit	Description
7:0	Capabilities Pointer (PTR) — RO. Indicates that the pointer for the first entry in the capabilities list is at 50h in configuration space.

23.2.1.12 INTR—Interrupt Information Register (Intel® MEI 2—D22:F1)

Address Offset: 3Ch–3Dh Attribute: R/W, RO
Default Value: 0100h Size: 16 bits

Bit	Description
15:8	Interrupt Pin (IPIN) — RO. This field indicates the interrupt pin the Intel MEI host controller uses. A value of 1h/2h/3h/4h indicates that this function implements legacy interrupt on INTA/INTB/INTC/INTD, respectively.
7:0	Interrupt Line (ILINE) — R/W. Software written value to indicate which interrupt line (vector) the interrupt is connected to. No hardware action is taken on this register.



23.2.1.13 HFS—Host Firmware Status Register (Intel® MEI 2—D22:F1)

Address Offset: 40h–43h Attribute: RO
 Default Value: 00000000h Size: 32 bits

Bit	Description
31:0	Host Firmware Status (HFS) — RO. This register field is used by Firmware to reflect the operating environment to the host.

23.2.1.14 GMES—General Intel® ME Status Register (Intel® MEI 2—D22:F1)

Address Offset: 48h–4Bh Attribute: RO
 Default Value: 00000000h Size: 32 bits

Bit	Description
31:0	General Intel ME Status (ME_GS) — RO. This field is populated by Intel ME.

23.2.1.15 H_GS—Host General Status Register (Intel® MEI 2—D22:F1)

Address Offset: 4Ch–4Fh Attribute: RO
 Default Value: 00000000h Size: 32 bits

Bit	Description
31:0	Host General Status(H_GS) — RO. General Status of Host, this field is not used by Hardware



Bit	Description
3	No_Soft_Reset (NSR) — RO. This bit indicates that when the Intel MEI host controller is transitioning from D3 _{hot} to D0 due to a power state command, it does not perform an internal reset. Configuration context is preserved.
2	Reserved
1:0	Power State (PS) — R/W. This field is used both to determine the current power state of the Intel MEI host controller and to set a new power state. The values are: 00 = D0 state (default) 11 = D3 _{hot} state The D1 and D2 states are not supported for the Intel MEI host controller. When in the D3 _{hot} state, the Intel ME's configuration space is available, but the register memory spaces are not. Additionally, interrupts are blocked.

23.2.1.19 MID—Message Signaled Interrupt Identifiers Register (Intel® MEI 2—D22:F1)

Address Offset: 8Ch-8Dh Attribute: RO
Default Value: 0005h Size: 16 bits

Bit	Description
15:8	Next Pointer (NEXT) — RO. Value of 00h indicates that this is the last item in the list.
7:0	Capability ID (CID) — RO. Capabilities ID indicates MSI.

23.2.1.20 MC—Message Signaled Interrupt Message Control Register (Intel® MEI 2—D22:F1)

Address Offset: 8Eh-8Fh Attribute: R/W, RO
Default Value: 0080h Size: 16 bits

Bit	Description
15:8	Reserved
7	64 Bit Address Capable (C64) — RO. Specifies that function is capable of generating 64-bit messages.
6:1	Reserved
0	MSI Enable (MSIE) — R/W. If set, MSI is enabled and traditional interrupt pins are not used to generate interrupts.

23.2.1.21 MA—Message Signaled Interrupt Message Address Register (Intel® MEI 2—D22:F1)

Address Offset: 90h-93h Attribute: R/W, RO
Default Value: 00000000h Size: 32 bits

Bit	Description
31:2	Address (ADDR) — R/W. Lower 32 bits of the system specified message address, always DW aligned.
1:0	Reserved



23.2.1.22 MUA—Message Signaled Interrupt Upper Address Register (Intel® MEI 2—D22:F1)

Address Offset: 94h–97h Attribute: R/W
Default Value: 00000000h Size: 32 bits

Bit	Description
31:0	Upper Address (UADDR) — R/W. Upper 32 bits of the system specified message address, always DW aligned.

23.2.1.23 MD—Message Signaled Interrupt Message Data Register (Intel® MEI 2—D22:F1)

Address Offset: 98h–99h Attribute: R/W
Default Value: 0000h Size: 16 bits

Bit	Description
15:0	Data (DATA) — R/W. This 16-bit field is programmed by system software if MSI is enabled. Its content is driven during the data phase of the MSI memory write transaction.

23.2.1.24 HIDM—Intel® MEI Interrupt Delivery Mode Register (Intel® MEI 2—D22:F1)

Address Offset: A0h Attribute: R/W
Default Value: 00h Size: 8 bits

Bit	Description
7:2	Reserved
1	Intel MEI Interrupt Delivery Mode (HIDM) — R/W. These bits control what type of interrupt the Intel MEI will send the host. They are interpreted as follows: 00 = Generate Legacy or MSI interrupt 01 = Generate SCI 10 = Generate SMI
0	Synchronous SMI Occurrence (SSMIO) — R/WC. This bit is used by firmware to indicate that a synchronous SMI source has been triggered. Host BIOS SMM handler can use this bit as status indication and clear it once processing is completed. A write of 1 from host SW clears this status bit. NOTE: It is possible that an async SMI has occurred prior to sync SMI occurrence and when the BIOS enters the SMM handler, it is possible that both bit 0 and bit 1 of this register could be set.



23.2.1.25 HERES—Intel® MEI Extend Register Status (Intel® MEI 2—D22:F1)

Address Offset: BCh–BFh Attribute: RO
Default Value: 00h Size: 32 bits

Bit	Description
31	Extend Register Valid (ERV). Set by firmware after all firmware has been loaded. If ERA field is SHA-1, the result of the extend operation is in HER:5-1. If ERA field is SHA-256, the result of the extend operation is in HER:8-1.
30	Extend Feature Present (EFP). This bit is hardwired to 1 to allow driver software to easily detect the chipset supports the Extend Register FW measurement feature.
29:4	Reserved
3:0	Extend Register Algorithm (ERA). This field indicates the hash algorithm used in the FW measurement extend operations. Encodings are: 0h = SHA-1 2h = SHA-256 Other values = Reserved

23.2.1.26 HERX—Intel® MEI Extend Register DWX (Intel® MEI 2—D22:F1)

Address Offset: HER1: C0h–C3h Attribute: RO
 HER2: C4h–C7h
 HER3: C8h–CBh
 HER4: CCh–CFh
 HER5: D0h–D3h
 HER6: D4h–D7h
 HER7: D8h–DBh
 HER8: DCh–DFh
Default Value: 00000000h Size: 32 bits

Bit	Description
31:0	Extend Register DWX (ERDWX): Xth DWORD result of the extend operation. NOTE: Extend Operation is HER[5:1] if using SHA-1. If using SHA-2, then Extend Operation is HER[8:1].

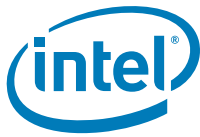

23.2.2 MEI1_MBAR—Intel® MEI 2 MMIO Registers

These MMIO registers are accessible starting at the Intel MEI 2 MMIO Base Address (MEI1_MBAR) which gets programmed into D22:F1:Offset 10–17h. These registers are reset by PLTRST# unless otherwise noted.

Table 23-4. Intel® MEI 2 MMIO Register Address Map

MEI1_MBAR + Offset	Mnemonic	Register Name	Default	Attribute
00–03h	H_CB_WW	Host Circular Buffer Write Window	00000000h	RO
04h–07h	H_CSR	Host Control Status	02000000h	R/W, R/WC, RO
08h–0Bh	ME_CB_RW	Intel ME Circular Buffer Read Window	00000000h	RO
0Ch–0Fh	ME_CSR_HA	Intel ME Control Status Host Access	02000000h	RO

23.2.2.1 H_CB_WW—Host Circular Buffer Write Window (Intel® MEI 2 MMIO Register)

Address Offset: MEI1_MBAR + 00h Attribute: RO
 Default Value: 00000000h Size: 32 bits

Bit	Description
31:0	Host Circular Buffer Write Window Field (H_CB_WWF). This bit field is for host to write into its circular buffer. The host's circular buffer is located at the Intel ME subsystem address specified in the Host CB Base Address register. This field is write only, reads will return arbitrary data. Writes to this register will increment the H_CBWP as long as ME_RDY is 1. When ME_RDY is 0, writes to this register have no effect and are not delivered to the H_CB, nor is H_CBWP incremented.



23.2.2.2 H_CSR—Host Control Status Register (Intel® MEI 2 MMIO Register)

Address Offset: MEI1_MBAR + 04h Attribute: RO, R/W, R/WC
 Default Value: 02000000h Size: 32 bits

Bit	Description
31:24	Host Circular Buffer Depth (H_CBD) — RO. This field indicates the maximum number of 32 bit entries available in the host circular buffer (H_CB). Host software uses this field along with the H_CBRP and H_CBWP fields to calculate the number of valid entries in the H_CB to read or # of entries available for write. This field is implemented with a "1-hot" scheme. Only one bit will be set to a "1" at a time. Each bit position represents the value n of a buffer depth of (2^n). For example, when bit# 1 is 1, the buffer depth is 2; when bit#2 is 1, the buffer depth is 4, etc. The allowed buffer depth values are 2, 4, 8, 16, 32, 64 and 128.
23:16	Host CB Write Pointer (H_CBWP) — RO. Points to next location in the H_CB for host to write the data. Software uses this field along with H_CBRP and H_CBD fields to calculate the number of valid entries in the H_CB to read or number of entries available for write.
15:8	Host CB Read Pointer (H_CBRP) — RO. Points to next location in the H_CB where a valid data is available for embedded controller to read. Software uses this field along with H_CBWP and H_CBD fields to calculate the number of valid entries in the host CB to read or number of entries available for write.
7:5	Reserved NOTE: For writes to this register, these bits shall be written as 000b.
4	Host Reset (H_RST) — R/W. Setting this bit to 1 will initiate a Intel MEI reset sequence to get the circular buffers into a known good state for host and Intel ME communication. When this bit transitions from 0 to 1, hardware will clear the H_RDY and ME_RDY bits.
3	Host Ready (H_RDY) — R/W. This bit indicates that the host is ready to process messages.
2	Host Interrupt Generate (H_IG) — R/W. Once message(s) are written into its CB, the host sets this bit to one for the HW to set the ME_IS bit in the ME_CSR and to generate an interrupt message to Intel ME. HW will send the interrupt message to Intel ME only if the ME_IE is enabled. HW then clears this bit to 0.
1	Host Interrupt Status (H_IS) — R/WC. Hardware sets this bit to 1 when ME_IG bit is set to 1. Host clears this bit to 0 by writing a 1 to this bit position. H_IE has no effect on this bit.
0	Host Interrupt Enable (H_IE) — R/W. Host sets this bit to 1 to enable the host interrupt (INTR# or MSI) to be asserted when H_IS is set to 1.



23.2.2.3 ME_CB_RW—Intel® ME Circular Buffer Read Window Register (Intel® MEI 2 MMIO Register)

Address Offset: MEI1_MBAR + 08h Attribute: RO
 Default Value: FFFFFFFFh Size: 32 bits

Bit	Description
31:0	Intel ME Circular Buffer Read Window Field (ME_CB_RWF). This bit field is for host to read from the Intel ME Circular Buffer. The Intel ME's circular buffer is located at the Intel ME subsystem address specified in the Intel ME CB Base Address register. This field is read only, writes have no effect. Reads to this register will increment the ME_CBRP as long as ME_RDY is 1. When ME_RDY is 0, reads to this register have no effect, all 1s are returned, and ME_CBRP is not incremented.

23.2.2.4 ME_CSR_HA—Intel® ME Control Status Host Access Register (Intel® MEI 2 MMIO Register)

Address Offset: MEI1_MBAR + 0Ch Attribute: RO
 Default Value: 02000000h Size: 32 bits

Bit	Description
31:24	Intel ME Circular Buffer Depth Host Read Access (ME_CBD_HRA). Host read only access to ME_CBD.
23:16	Intel ME CB Write Pointer Host Read Access (ME_CBWP_HRA). Host read only access to ME_CBWP.
15:8	Intel ME CB Read Pointer Host Read Access (ME_CBRP_HRA). Host read only access to ME_CBRP.
7:5	Reserved
4	Intel ME Reset Host Read Access (ME_RST_HRA). Host read access to ME_RST.
3	Intel ME Ready Host Read Access (ME_RDY_HRA). Host read access to ME_RDY.
2	Intel ME Interrupt Generate Host Read Access (ME_IG_HRA). Host read only access to ME_IG.
1	Intel ME Interrupt Status Host Read Access (ME_IS_HRA). Host read only access to ME_IS.
0	Intel ME Interrupt Enable Host Read Access (ME_IE_HRA). Host read only access to ME_IE.



23.3 IDE Redirect IDER Registers (IDER – D22:F2)

23.3.1 PCI Configuration Registers (IDER–D22:F2)

Table 23-5. IDE Redirect Function IDER Register Address Map

Address Offset	Register Symbol	Register Name	Default Value	Attribute
00h–01h	VID	Vendor Identification	8086h	RO
02h–03h	DID	Device Identification	See register description	RO
04h–05h	PCICMD	PCI Command	0000h	RO, R/W
06h–07h	PCISTS	PCI Status	00B0h	RO
08h	RID	Revision ID	See register description	RO
09h–0Bh	CC	Class Codes	010185h	RO
0Ch	CLS	Cache Line Size	00h	RO
10h–13h	PCMDBA	Primary Command Block IO Bar	00000001h	RO, R/W
14h–17h	PCTLBA	Primary Control Block Base Address	00000001h	RO, R/W
18h–1Bh	SCMDBA	Secondary Command Block Base Address	00000001h	RO, R/W
1Ch–1Fh	SCTLBA	Secondary Control Block base Address	00000001h	RO, R/W
20h–23h	LBAR	Legacy Bus Master Base Address	00000001h	RO, R/W
2Ch–2Dh	SVID	Subsystem Vendor ID	0000h	R/WO
2Eh–2Fh	SID	Subsystem ID	8086h	R/WO
34h	CAPP	Capabilities Pointer	C8h	RO
3Ch–3Dh	INTR	Interrupt Information	0300h	R/W, RO
C8h–C9h	PID	PCI Power Management Capability ID	D001h	RO
CAh–CBh	PC	PCI Power Management Capabilities	0023h	RO
CCh–CFh	PMCS	PCI Power Management Control and Status	00000000h	RO, R/W, RO/V
D0h–D1h	MID	Message Signaled Interrupt Capability ID	0005h	RO
D2h–D3h	MC	Message Signaled Interrupt Message Control	0080h	RO, R/W
D4h–D7h	MA	Message Signaled Interrupt Message Address	00000000h	R/W, RO
D8h–DBh	MAU	Message Signaled Interrupt Message Upper Address	00000000h	RO, R/W
DC–DDh	MD	Message Signaled Interrupt Message Data	0000h	R/W



23.3.1.1 VID—Vendor Identification Register (IDER—D22:F2)

Address Offset: 00–01h Attribute: RO
Default Value: 8086h Size: 16 bits

Bit	Description
15:0	Vendor ID (VID) — RO. This is a 16-bit value assigned by Intel.

23.3.1.2 DID—Device Identification Register (IDER—D22:F2)

Address Offset: 02–03h Attribute: RO
Default Value: See bit description Size: 16 bits

Bit	Description
15:0	Device ID (DID) — RO. This is a 16-bit value assigned to the PCH IDER controller. See the <i>Intel® 6 Series Chipset and Intel® C200 Series Chipset Specification Update</i> for the value of the DID Register.

23.3.1.3 PCICMD— PCI Command Register (IDER—D22:F2)

Address Offset: 04–05h Attribute: RO, R/W
Default Value: 0000h Size: 16 bits

Bit	Description
15:11	Reserved
10	Interrupt Disable (ID) —R/W. This disables pin-based INTx# interrupts. This bit has no effect on MSI operation. When set, internal INTx# messages will not be generated. When cleared, internal INTx# messages are generated if there is an interrupt and MSI is not enabled.
9:3	Reserved
2	Bus Master Enable (BME) —RO. This bit controls the PT function's ability to act as a master for data transfers. This bit does not impact the generation of completions for split transaction commands.
1	Memory Space Enable (MSE) —RO. PT function does not contain target memory space.
0	I/O Space enable (IOSE) —RO. This bit controls access to the PT function's target I/O space.



23.3.1.8 PCMDBA—Primary Command Block IO Bar Register (IDER—D22:F2)

Address Offset: 10–13h Attribute: RO, R/W
Default Value: 00000001h Size: 32 bits

Bit	Description
31:16	Reserved
15:3	Base Address (BAR) —R/W Base Address of the BAR0 I/O space (8 consecutive I/O locations).
2:1	Reserved
0	Resource Type Indicator (RTE) —RO. This bit indicates a request for I/O space.

23.3.1.9 PCTLBA—Primary Control Block Base Address Register (IDER—D22:F2)

Address Offset: 14–17h Attribute: RO, R/W
Default Value: 00000001h Size: 32 bits

Bit	Description
31:16	Reserved
15:2	Base Address (BAR) —R/W. Base Address of the BAR1 I/O space (4 consecutive I/O locations)
1	Reserved
0	Resource Type Indicator (RTE) —RO. This bit indicates a request for I/O space

23.3.1.10 SCMDBA—Secondary Command Block Base Address Register (IDER—D22:F2)

Address Offset: 18–1Bh Attribute: RO, R/W
Default Value: 00000001h Size: 32 bits

Bit	Description
31:16	Reserved
15:3	Base Address (BAR) —R/W. Base Address of the I/O space (8 consecutive I/O locations).
2:1	Reserved
0	Resource Type Indicator (RTE) —RO. This bit indicates a request for I/O space.

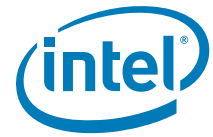

23.3.1.11 SCTLBA—Secondary Control Block base Address Register (IDER—D22:F2)

Address Offset: 1C–1Fh Attribute: RO, R/W
 Default Value: 00000001h Size: 32 bits

Bit	Description
31:16	Reserved
15:2	Base Address (BAR) —R/W. Base Address of the I/O space (4 consecutive I/O locations).
1	Reserved
0	Resource Type Indicator (RTE) —RO. This bit indicates a request for I/O space.

23.3.1.12 LBAR—Legacy Bus Master Base Address Register (IDER—D22:F2)

Address Offset: 20–23h Attribute: RO, R/W
 Default Value: 00000001h Size: 32 bits

Bit	Description
31:16	Reserved
15:4	Base Address (BA) —R/W. Base Address of the I/O space (16 consecutive I/O locations).
3:1	Reserved
0	Resource Type Indicator (RTE) —RO. This bit indicates a request for I/O space.

23.3.1.13 SVID—Subsystem Vendor ID Register (IDER—D22:F2)

Address Offset: 2Ch–2Dh Attribute: R/WO
 Default Value: 0000h Size: 16 bits

Bit	Description
15:0	Subsystem Vendor ID (SSVID) — R/WO. Indicates the sub-system vendor identifier. This field should be programmed by BIOS during boot-up. Once written, this register becomes Read Only. This field can only be cleared by PLTRST#. NOTE: Register must be written as a DWord write with SID register.

23.3.1.14 SID—Subsystem ID Register (IDER—D22:F2)

Address Offset: 2Eh–2Fh Attribute: R/WO
 Default Value: 8086h Size: 16 bits

Bit	Description
15:0	Subsystem ID (SSID) — R/WO. Indicates the sub-system identifier. This field should be programmed by BIOS during boot-up. Once written, this register becomes Read Only. This field can only be cleared by PLTRST#. NOTE: Register must be written as a DWord write with SVID register.



23.3.1.15 CAPP—Capabilities List Pointer Register (IDER—D22:F2)

Address Offset: 34h Attribute: RO
Default Value: C8h Size: 8 bits

Bit	Description
7:0	Capability Pointer (CP) — R/WO. This field indicates that the first capability pointer is offset C8h (the power management capability).

23.3.1.16 INTR—Interrupt Information Register (IDER—D22:F2)

Address Offset: 3C–3Dh Attribute: R/W, RO
Default Value: 0300h Size: 16 bits

Bit	Description
15:8	Interrupt Pin (IPIN) — RO. A value of 1h/2h/3h/4h indicates that this function implements legacy interrupt on INTA/INTB/INTC/INTD, respectively FunctionValueINTx (2 IDE)03hINTC
7:0	Interrupt Line (ILINE) — R/W. The value written in this register indicates which input of the system interrupt controller, the device's interrupt pin is connected to. This value is used by the OS and the device driver, and has no affect on the hardware.

23.3.1.17 PID—PCI Power Management Capability ID Register (IDER—D22:F2)

Address Offset: C8–C9h Attribute: RO
Default Value: D001h Size: 16 bits

Bit	Description
15:8	Next Capability (NEXT) — RO. Its value of D0h points to the MSI capability.
7:0	Cap ID (CID) — RO. This field indicates that this pointer is a PCI power management.

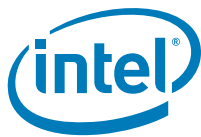

23.3.1.20 MID—Message Signaled Interrupt Capability ID Register (IDER—D22:F2)

Address Offset: D0–D1h Attribute: RO
Default Value: 0005h Size: 16 bits

Bit	Description
15:8	Next Pointer (NEXT) — RO. This value indicates this is the last item in the capabilities list.
7:0	Capability ID (CID) — RO. The Capabilities ID value indicates device is capable of generating an MSI.

23.3.1.21 MC—Message Signaled Interrupt Message Control Register (IDER—D22:F2)

Address Offset: D2–D3h Attribute: RO, R/W
Default Value: 0080h Size: 16 bits

Bit	Description
15:8	Reserved
7	64 Bit Address Capable (C64) — RO. Capable of generating 64-bit and 32-bit messages.
6:4	Multiple Message Enable (MME) — R/W. These bits are R/W for software compatibility, but only one message is ever sent by the PT function.
3:1	Multiple Message Capable (MMC) — RO. Only one message is required.
0	MSI Enable (MSIE) — R/W. If set, MSI is enabled and traditional interrupt pins are not used to generate interrupts.

23.3.1.22 MA—Message Signaled Interrupt Message Address Register (IDER—D22:F2)

Address Offset: D4–D7h Attribute: R/W, RO
Default Value: 00000000h Size: 32 bits

Bit	Description
31:2	Address (ADDR) — R/W. This field contains the Lower 32 bits of the system specified message address, always DWord aligned
1:0	Reserved

23.3.1.23 MAU—Message Signaled Interrupt Message Upper Address Register (IDER—D22:F2)

Address Offset: D8–DBh Attribute: RO, R/W
Default Value: 00000000h Size: 32 bits

Bit	Description
31:4	Reserved
3:0	Address (ADDR) — R/W. This field contains the Upper 4 bits of the system specified message address.



23.3.1.24 MD—Message Signaled Interrupt Message Data Register (IDER—D22:F2)

Address Offset: DC–DDh
Default Value: 0000h

Attribute: R/W
Size: 16 bits

Bit	Description
15:0	Data (DATA) — R/W. This content is driven onto the lower word of the data bus of the MSI memory write transaction.

23.3.2 IDER BAR0 Registers

Table 23-6. IDER BAR0 Register Address Map

Address Offset	Register Symbol	Register Name	Default Value	Attribute
0h	IDEDATA	IDE Data Register	00h	R/W
1h	IDEERD1	IDE Error Register DEV1	00h	R/W
1h	IDEERD0	IDE Error Register DEV0	00h	R/W
1h	IDEFR	IDE Features Register	00h	R/W
2h	IDESCIR	IDE Sector Count In Register	00h	R/W
2h	IDESCOR1	IDE Sector Count Out Register Device 1	00h	R/W
2h	IDESCOR0	IDE Sector Count Out Register Device 0	00h	R/W
3h	IDESNOR0	IDE Sector Number Out Register Device 0	00h	R/W
3h	IDESNOR1	IDE Sector Number Out Register Device 1	00h	R/W
3h	IDESNIR	IDE Sector Number In Register	00h	R/W
4h	IDECLIR	IDE Cylinder Low In Register	00h	R/W
4h	IDCLOR1	IDE Cylinder Low Out Register Device 1	00h	R/W
4h	IDCLOR0	IDE Cylinder Low Out Register Device 0	00h	R/W
5h	IDCHOR0	IDE Cylinder High Out Register Device 0	00h	R/W
5h	IDCHOR1	IDE Cylinder High Out Register Device 1	00h	R/W
5h	IDECHIR	IDE Cylinder High In Register	00h	R/W
6h	IDEDHIR	IDE Drive/Head In Register	00h	R/W
6h	IDDHOR1	IDE Drive Head Out Register Device 1	00h	R/W
6h	IDDHOR0	IDE Drive Head Out Register Device 0	00h	R/W



23.3.4 IDER BAR4 Registers

Table 23-8. IDER BAR4 Register Address Map

Address Offset	Register Symbol	Register Name	Default Value	Attribute
0h	IDEPBMCR	IDE Primary Bus Master Command Register	00h	RO, R/W
1h	IDEPBMDS0R	IDE Primary Bus Master Device Specific 0 Register	00h	R/W
2h	IDEPBMSR	IDE Primary Bus Master Status Register	80h	RO, R/W
3h	IDEPBMDS1R	IDE Primary Bus Master Device Specific 1 Register	00h	R/W
4h	IDEPBMDTPR0	IDE Primary Bus Master Descriptor Table Pointer Register Byte 0	00h	R/W
5h	IDEPBMDTPR1	IDE Primary Bus Master Descriptor Table Pointer Register Byte 1	00h	R/W
6h	IDEPBMDTPR2	IDE Primary Bus Master Descriptor Table Pointer Register Byte 2	00h	R/W
7h	IDEPBMDTPR3	IDE Primary Bus Master Descriptor Table Pointer Register Byte 3	00h	R/W
8h	IDESBMCR	IDE Secondary Bus Master Command Register	00h	RO, R/W
9h	IDESBMDS0R	IDE Secondary Bus Master Device Specific 0 Register	00h	R/W
Ah	IDESBMSR	IDE Secondary Bus Master Status Register	00h	R/W, RO
Bh	IDESBMDS1R	IDE Secondary Bus Master Device Specific 1 Register	00h	R/W
Ch	IDESBMDTPR0	IDE Secondary Bus Master Descriptor Table Pointer Register Byte 0	00h	R/W
Dh	IDESBMDTPR1	IDE Secondary Bus Master Descriptor Table Pointer Register Byte 1	00h	R/W
Eh	IDESBMDTPR2	IDE Secondary Bus Master Descriptor Table Pointer Register Byte 2	00h	R/W
Fh	IDESBMDTPR3	IDE Secondary Bus Master Descriptor Table Pointer Register Byte 3	00h	R/W



23.4 Serial Port for Remote Keyboard and Text (KT) Redirection (KT – D22:F3)

23.4.1 PCI Configuration Registers (KT – D22:F3)

Table 23-9. Serial Port for Remote Keyboard and Text (KT) Redirection Register Address Map

Address Offset	Register Symbol	Register Name	Default Value	Attribute
00h–01h	VID	Vendor Identification	8086h	RO
02h–03h	DID	Device Identification	See Register description	RO
04h–05h	CMD	Command Register	0000h	RO, R/W
06h–07h	STS	Device Status	00B0h	RO
08h	RID	Revision ID	See Register description	RO
09h–0Bh	CC	Class Codes	070002h	RO
0Ch	CLS	Cache Line Size	00h	RO
10h–13h	KTIBA	KT IO Block Base Address	00000001h	RO, R/W
14h–17h	KT MBA	KT Memory Block Base Address	00000000h	RO, R/W
2Ch–2Dh	SVID	Subsystem Vendor ID	0000h	R/WO
2Eh–2Fh	SID	Subsystem ID	8086h	R/WO
34h	CAP	Capabilities Pointer	C8h	RO
3Ch–3Dh	INTR	Interrupt Information	0200h	R/W, RO
C8h–C9h	PID	PCI Power Management Capability ID	D001h	RO
CAh–CBh	PC	PCI Power Management Capabilities	0023h	RO
D0h–D1h	MID	Message Signaled Interrupt Capability ID	0005h	RO
D2h–D3h	MC	Message Signaled Interrupt Message Control	0080h	RO, R/W
D4h–D7h	MA	Message Signaled Interrupt Message Address	00000000h	RO, R/W
D8h–DBh	MAU	Message Signaled Interrupt Message Upper Address	00000000h	RO, R/W
DCh–DDh	MD	Message Signaled Interrupt Message Data	0000h	R/W



23.4.1.1 VID—Vendor Identification Register (KT—D22:F3)

Address Offset: 00–01h Attribute: RO
Default Value: 8086h Size: 16 bits

Bit	Description
15:0	Vendor ID (VID) — RO. This is a 16-bit value assigned by Intel.

23.4.1.2 DID—Device Identification Register (KT—D22:F3)

Address Offset: 02–03h Attribute: RO
Default Value: See bit description Size: 16 bits

Bit	Description
15:0	Device ID (DID) — RO. This is a 16-bit value assigned to the PCH KT controller. See the <i>Intel® 6 Series Chipset and Intel® C200 Series Chipset Specification Update</i> for the value of the DID Register.

23.4.1.3 CMD—Command Register (KT—D22:F3)

Address Offset: 04–05h Attribute: RO, R/W
Default Value: 0000h Size: 16 bits

Bit	Description
15:11	Reserved
10	Interrupt Disable (ID) — R/W. This bit disables pin-based INTx# interrupts. This bit has no effect on MSI operation. 1 = Internal INTx# messages will not be generated. 0 = Internal INTx# messages are generated if there is an interrupt and MSI is not enabled.
9:3	Reserved
2	Bus Master Enable (BME) — R/W. This bit controls the KT function's ability to act as a master for data transfers. This bit does not impact the generation of completions for split transaction commands. For KT, the only bus mastering activity is MSI generation.
1	Memory Space Enable (MSE) — R/W. This bit controls Access to the PT function's target memory space.
0	I/O Space enable (IOSE) — R/W. This bit controls access to the PT function's target I/O space.



23.4.1.4 STS—Device Status Register (KT—D22:F3)

Address Offset: 06–07h Attribute: RO
 Default Value: 00B0h Size: 16 bits

Bit	Description
15:11	Reserved
10:9	DEVSEL# Timing Status (DEVT) — RO. This field controls the device select time for the PT function's PCI interface.
8:5	Reserved
4	Capabilities List (CL) — RO. This bit indicates that there is a capabilities pointer implemented in the device.
3	Interrupt Status (IS) — RO. This bit reflects the state of the interrupt in the function. Setting of the Interrupt Disable bit to 1 has no affect on this bit. Only when this bit is a 1 and ID bit is 0 is the INTB interrupt asserted to the Host.
2:0	Reserved

23.4.1.5 RID—Revision ID Register (KT—D22:F3)

Address Offset: 08h Attribute: RO
 Default Value: See bit description Size: 8 bits

Bit	Description
7:0	Revision ID (RID) — RO. See the <i>Intel® 6 Series Chipset and Intel® C200 Series Chipset Specification Update</i> for the value of the RID Register.

23.4.1.6 CC—Class Codes Register (KT—D22:F3)

Address Offset: 09–0Bh Attribute: RO
 Default Value: 070002h Size: 24 bits

Bit	Description
23:16	Base Class Code (BCC) —RO This field indicates the base class code of the KT host controller device.
15:8	Sub Class Code (SCC) —RO This field indicates the sub class code of the KT host controller device.
7:0	Programming Interface (PI) —RO This field indicates the programming interface of the KT host controller device.



23.4.1.14 PID—PCI Power Management Capability ID Register (KT—D22:F3)

Address Offset: C8–C9h Attribute: RO
Default Value: D001h Size: 16 bits

Bit	Description
15:8	Next Capability (NEXT) — RO. A value of D0h points to the MSI capability.
7:0	Cap ID (CID) — RO. This field indicates that this pointer is a PCI power management.

23.4.1.15 PC—PCI Power Management Capabilities ID Register (KT—D22:F3)

Address Offset: CA–CBh Attribute: RO
Default Value: 0023h Size: 16 bits

Bit	Description
15:11	PME Support (PME) — RO. This field indicates no PME# in the PT function.
10:6	Reserved
5	Device Specific Initialization (DSI) — RO. This bit indicates that no device-specific initialization is required.
4	Reserved
3	PME Clock (PMEC) — RO. This bit indicates that PCI clock is not required to generate PME#
2:0	Version (VS) — RO. This field indicates support for the <i>PCI Power Management Specification, Revision 1.2</i> .



23.4.2.6 KTIIR—KT Interrupt Identification Register (KT—D22:F3)

Address Offset: 02h Attribute: RO
 Default Value: 00h Size: 8 bits

The KT IIR register prioritizes the interrupts from the function into 4 levels and records them in the IIR_STAT field of the register. When Host accesses the IIR, hardware freezes all interrupts and provides the priority to the Host. Hardware continues to monitor the interrupts but does not change its current indication until the Host read is over. Table in the Host Interrupt Generation section shows the contents.

Bit	Description
7	FIFO Enable (FIEN1) — RO. This bit is connected by hardware to bit 0 in the FCR register.
6	FIFO Enable (FIEN0) — RO. This bit is connected by hardware to bit 0 in the FCR register.
5:4	Reserved
3:1	IIR STATUS (IIRSTS) — RO. These bits are asserted by the hardware according to the source of the interrupt and the priority level.
0	Interrupt Status (INTSTS) — RO. 0 = Pending interrupt to Host 1 = No pending interrupt to Host

23.4.2.7 KTFPCR—KT FIFO Control Register (KT—D22:F3)

Address Offset: 02h Attribute: WO
 Default Value: 00h Size: 8 bits

When Host writes to this address, it writes to the KTFPCR. The FIFO control Register of the serial interface is used to enable the FIFOs, set the receiver FIFO trigger level and clear FIFOs under the direction of the Host.

When Host reads from this address, it reads the KTIIR.

Bit	Description
7:6	Receiver Trigger Level (RTL) — WO. Trigger level in bytes for the RCV FIFO. Once the trigger level number of bytes is reached, an interrupt is sent to the Host. 00 = 01 01 = 04 10 = 08 11 = 14
5:3	Reserved
2	XMT FIFO Clear (XFIC) — WO. When the Host writes one to this bit, the hardware will clear the XMT FIFO. This bit is self-cleared by hardware.
1	RCV FIFO Clear (RFIC) — WO. When the Host writes one to this bit, the hardware will clear the RCV FIFO. This bit is self-cleared by hardware.
0	FIFO Enable (FIE) — WO. When set, this bit indicates that the KT interface is working in FIFO mode. When this bit value is changed the RCV and XMT FIFO are cleared by hardware.

