

RAM1A..G



1-pole, solid state relay with LED and built-in Varistor, VDE certified



Main features

- AC switching Solid State Relay
- Direct copper bonding (DCB) technology
- Back to Back thyristor output
- VDE certified for Glow wire test according to IEC/EN 60335-1
- 100,000 cycles UL endurance test*
- Integrated overvoltage protection
- LED for control presence indication
- Clip-on IP20 protection cover
- Self-lifting terminals
- 65 kA UL short circuit current rating

* selected models

Description

The industrial, 1-phase relay with antiparallel thyristor output is the most widely used industrial SSR due to its multiple application possibilities. The relay can be used for resistive, inductive and capacitive loads. The zero switching relay switches ON when the sinusoidal curve crosses zero and switches OFF when the current crosses zero. The built-in varistor secures transient protection. The LED indicates the status of the control input. The clipon cover secures touch protection (IP 20). Protected output terminals can handle cables up to 16 mm².

Specifications are at a surrounding temperature of 25°C unless otherwise specified.

Applications

Plastic injection machines, Extrusion machines, Blow moulding machines, Thermoformers, Dryers, Electrical ovens, Fryers, Shrink tunnels, Air handling units, Sterilisation equipment, Climatic chambers, Ovens and furnaces, Ambient heating.

Main functions

- 1-pole, zero cross switching
- Rated output voltage up to 660 VAC
- Rated output current up to 125 AAC
- 3(4)-32 VDC or 20-280 VAC/22-48 VDC control voltage range

Order code

 RAM1A G

 Enter the code option instead of . Refer to the Selection guide section for valid part numbers.

Code	Option	Description	Comments
R	-		
A	-	Solid State Relay (RAM)	
M	-		
1	-	1-pole switching	
A	-	Zero Cross switching (ZC)	
<input type="checkbox"/>	23	Rated voltage: 24-265 VAC, 650 Vp	
	60	Rated voltage: 42-660 VAC, 1200 Vp	
<input type="checkbox"/>	D	Control voltage: 3-32 VDC	4-32 VDC for 600 VAC version
	A	Control voltage: 20-280 VAC/22-48 VDC	
<input type="checkbox"/>	25	Rated current: 25 AAC (525 A ² s)	
	50	Rated current: 50 AAC (1800 A ² s)	
	51	Rated current: 50 AAC (3200 A ² s)	
	100	Rated current: 100 AAC (6600 A ² s)	
	125	Rated current: 125 AAC (18000 A ² s)	
G	-	Glow wire certified (EN60335-1)	

Selection guide

Rated voltage, Blocking voltage, Switching mode	Control voltage	Maximum rated operational current				
		25 AAC (525 A ² s)	50 AAC (1800 A ² s)	51 AAC (3200 A ² s)	100 AAC (6600 A ² s)	125 AAC (18000 A ² s)
230 VAC, 650 Vp, ZC	3-32 VDC	RAM1A23D25G	RAM1A23D50G	-	-	-
	20-280 VAC, 24-48 VDC	RAM1A23A25G	RAM1A23A50G	-	-	-
600 VAC, 1200 Vp, ZC	4-32 VDC	RAM1A60D25G	RAM1A60D50G	RAM1A60D51G	RAM1A60D100G	RAM1A60D125G
	20-280 VAC, 24-48 VDC	RAM1A60A25G	RAM1A60A50G	RAM1A60A51G	RAM1A60A100G	RAM1A60A125G

Carlo Gavazzi compatible components

Description	Component code	Notes
FASTON terminals	RM48**/F4*	- Faston tabs (pack of 20) - Tab dimensions according to DIN 46342 part 1 - Pure tin-plated brass
Fork terminals	RM635FK/P	- Terminal adaptors for 35mm ² cable - Type RM635FK (P version with touch protection) - Pack size: 10 pieces
Thermal pads	KK071CUT	- Graphite thermal pad with adhesive on one side - Dimensions: 35 x 43 x 0.25mm - Packing quantity: 50pcs
Touch safety cover	RMIP20	- IP20 protection degree - Pack size: 20 pieces
Heatsinks	RHS	Heatsink and accessories
Mounting screws kit	SRWKITM5X10MM	- M5 x 10 mm with captivated washer - Pack size: 20 pieces

Carlo Gavazzi further reading

Information	Where to find it	Notes
Datasheet	https://gavazziautomation.com/images/PIM/DATASHEET/ENG/SSR_Accessories.pdf	Solid state relay Accessories (including Heatsinks)
	https://gavazziautomation.com/nsc/hq/en/solid_state_relays	Online Heatsink selector tool

Structure

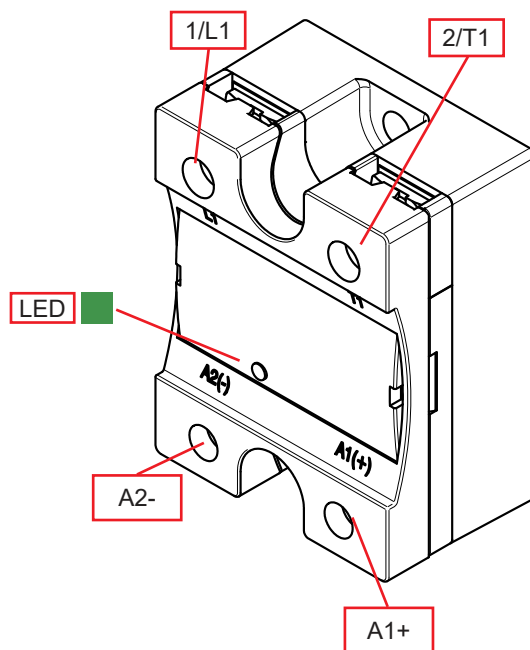

Element	Component	Function
1/L1	Power connection	Mains connection
2/T1	Power connection	Load connection
A1+, A2-	Control connection	Terminals for control voltage
LED	ON indicator	Indicates presence of control voltage

Features

General data

Material	PA66 or PA6 (UL94 V0), RAL7035 Glow wire ignition temperature and Glow wire flammability index conform to EN 60335-1 requirements	
Mounting	Panel mount	
Touch Protection	IP20	
Baseplate	25 A, 50 A 100 A, 125 A	Aluminium Copper, nickel-plated
Overvoltage Category	III, 6 kV (1.2/50 μ s) rated impulse withstand voltage	
Isolation	Input and Output to case Input to Output	4000 Vrms 4000 Vrms
Weight	25 A, 50 A 100 A, 125 A	approx. 60g approx. 100g

Performance

Output specifications

	RAM1A..25	RAM1A..50	RAM1A..51	RAM1A..100	RAM1A..125
Max. operational current¹: AC-51	25 AAC	50 AAC	50 AAC	100 AAC	125 AAC
Max. operational current¹: AC-53a	5 AAC	15 AAC	15 AAC	20 AAC	30 AAC
Operational frequency range	45 to 65 Hz				
Output protection	Integrated varistor				
Leakage current @ rated voltage	<3 mAAC				
Minimum operational current	150 mAAC	250 mAAC	400 mAAC	400 mAAC	500 mAAC
Repetitive overload current t=1 s	< 55 AAC	< 125 AAC	< 125 AAC	< 150 AAC	< 200AAC
Non-repetitive surge current (I_{TSM}), t=10 ms	325 Ap	600 Ap	800 Ap	1150 Ap	1900 Ap
I²t for fusing (t=10 ms), minimum	525 A ² s	1800 A ² s	3200 A ² s	6600 A ² s	18000 A ² s
Power factor	>0.5 at rated voltage				
Critical dV/dt (@T_j init = 40°C)	1000 V/ μ s				
Endurance testing acc. to UL 508²	100,000 cycles	100,000 cycles	6,000 cycles	100,000 cycles	6,000 cycles

1. Refer to Heatsink selection section
2. UL requirement for General Use Endurance Testing is 6,000 cycles

Output voltage specifications

	RAM1A23..	RAM1A60..
Operational voltage range	24 to 265 VACrms	42 to 660 VACrms
Blocking voltage	650 Vp	1200 Vp

Motor ratings*: HP (UL508)

	230 VAC	400 VAC	480 VAC	600 VAC
RAM1..25	1.5 HP	3 HP	3 HP	5 HP
RAM1..50, 51	3 HP	5 HP	7.5 HP	10 HP
RAM1..100	7.5 HP	15 HP	20 HP	25 HP
RAM1..125	10 HP	15 HP	25 HP	30 HP

* With suitable heatsink.

Inputs

		RAM1...D..	RAM1...A..
Control voltage range	RAM1A23... RAM1A60...	3 - 32 VDC 4 - 32 VDC	20-280 VAC, 22-48 VDC
Pick-up voltage	RAM1A23... RAM1A60...	2.5 VDC 3.5 VDC	18 VAC/DC
Drop-out voltage		1.2 VDC	6 VAC/DC
Maximum reverse voltage		32 VDC	-
Maximum response time pick-up		1/2 cycle	≤ 12 ms
Response time drop-out		≤ 1/2 cycle	≤ 40 ms
Input current @ max input voltage		≤ 12 mA	≤ 20 mA

Output power dissipation

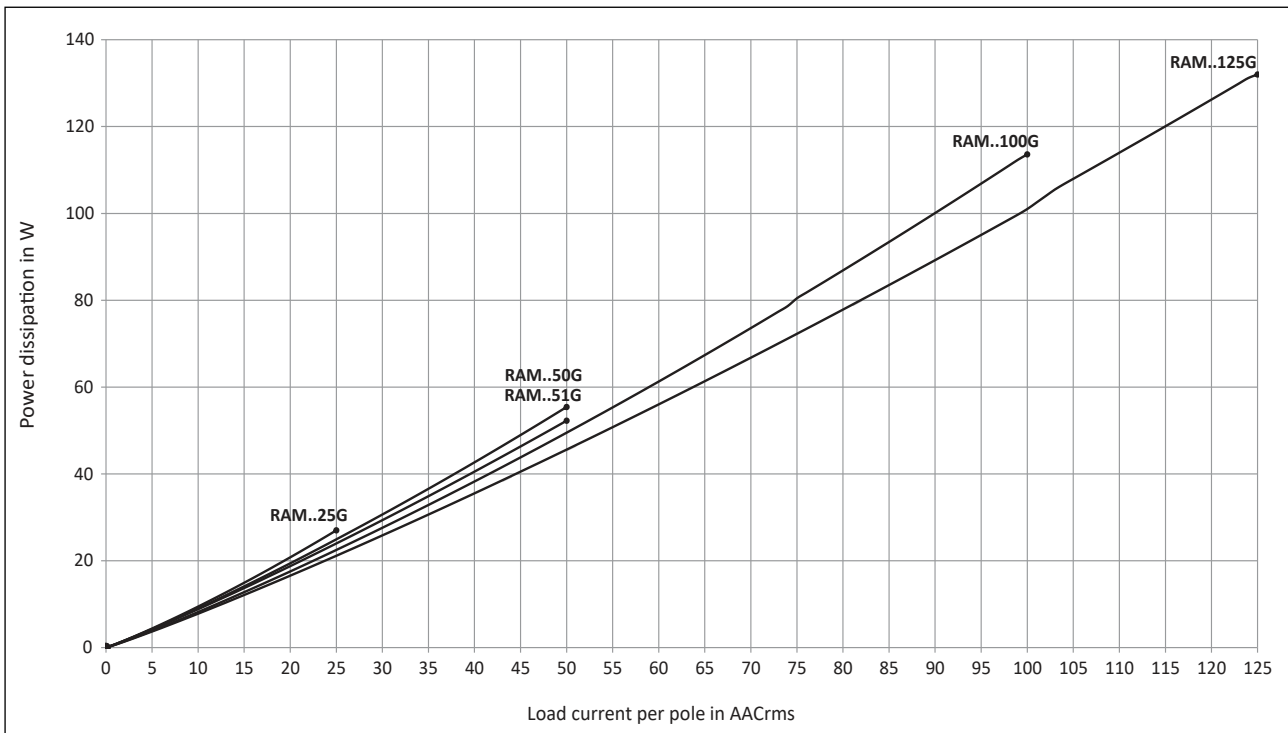

Heatsink selection

Thermal resistance [°C/W] of RAM1A..25

Load current [A]	Surrounding ambient temperature [°C]						
	20	30	40	50	60	70	80
25.0	3.23	2.80	2.37	1.94	1.51	1.09	0.66
22.5	3.70	3.21	2.73	2.24	1.75	1.26	0.78
20.0	4.30	3.74	3.17	2.61	2.05	1.49	0.92
17.5	5.07	4.41	3.76	3.10	2.44	1.78	1.12
15.0	6.12	5.33	4.54	3.75	2.96	2.17	1.38
12.5	7.58	6.61	5.64	4.66	3.69	2.72	1.75
10.0	9.80	8.55	7.30	6.05	4.80	3.55	2.30
7.5	13.5	11.8	10.09	8.37	6.66	4.94	3.23
5.0	nh	18.3	15.7	13.04	10.39	7.74	5.09
2.5	nh	nh	nh	nh	nh	16.2	10.7

Thermal resistance [°C/W] of RAM1A..50, 51

Load current [A]	Surrounding ambient temperature [°C]						
	20	30	40	50	60	70	80
50.0	1.25	1.07	0.88	0.70	0.52	0.34	0.16
45.0	1.46	1.25	1.04	0.84	0.63	0.42	0.21
40.0	1.73	1.49	1.25	1.01	0.77	0.52	0.28
35.0	2.08	1.80	1.51	1.23	0.94	0.66	0.37
30.0	2.56	2.22	1.87	1.53	1.18	0.84	0.49
25.0	3.24	2.81	2.38	1.95	1.52	1.09	0.66
20.0	4.26	3.71	3.15	2.59	2.03	1.47	0.92
15.0	5.99	5.22	4.45	3.67	2.90	2.12	1.35
10.0	9.49	8.27	7.06	5.85	4.64	3.43	2.22
5.0	nh	17.5	15.0	12.4	9.91	7.39	4.86

Thermal resistance [°C/W] of RAM1A..100

Load current [A]	Surrounding ambient temperature [°C]						
	20	30	40	50	60	70	80
100.0	0.60	0.52	0.43	0.34	0.26	0.17	0.09
90.0	0.74	0.64	0.54	0.44	0.34	0.24	0.14
80.0	0.91	0.79	0.68	0.56	0.45	0.33	0.22
70.0	1.09	0.96	0.82	0.68	0.55	0.41	0.27
60.0	1.33	1.16	1.00	0.83	0.66	0.50	0.33
50.0	1.66	1.45	1.24	1.04	0.83	0.62	0.41
40.0	2.16	1.89	1.62	1.35	1.08	0.81	0.54
30.0	3.01	2.64	2.26	1.88	1.51	1.13	0.75
20.0	4.73	4.14	3.55	2.96	2.37	1.78	1.18
10.0	9.94	8.70	7.45	6.21	4.97	3.73	2.48

Thermal resistance [°C/W] of RAM1A..125

Load current [A]	Surrounding ambient temperature [°C]						
	20	30	40	50	60	70	80
125.0	0.63	0.55	0.47	0.40	0.32	0.24	0.16
112.5	0.73	0.64	0.54	0.45	0.36	0.27	0.18
100.0	0.84	0.74	0.63	0.53	0.42	0.32	0.21
87.5	0.99	0.87	0.74	0.62	0.50	0.37	0.25
75.0	1.20	1.05	0.90	0.75	0.60	0.45	0.30
62.5	1.48	1.30	1.11	0.93	0.74	0.56	0.37
50.0	1.92	1.68	1.44	1.20	0.96	0.72	0.48
37.5	2.65	2.32	1.98	1.65	1.32	0.99	0.66
25.0	4.12	3.60	3.09	2.57	2.06	1.54	1.03
12.5	8.55	7.48	6.41	5.34	4.27	3.21	2.14







'nh' means no heatsink necessary. The SSR should still be tightened to a surface to ensure optimal thermal dissipation.

Thermal data

	RAM..25	RAM..50, 51	RAM..100	RAM..125
Max. junction temperature	125°C	125°C	125°C	125°C
Junction to case thermal resistance, R_{thjc}	<0.80°C/W	<0.50°C/W	<0.35°C/W	<0.30°C/W
Case to heatsink thermal resistance, R_{thcs}^3	< 0.20°C/W	< 0.20°C/W	<0.10°C/W	<0.10°C/W

3. Thermal resistance case to heatsink values are applicable upon application of a fine layer of silicon based thermal paste HTS02S from Electrolube between SSR and heatsink

Compatibility and conformance

Approvals	      
Standards compliance	LVD: EN 60947-4-3 / EE: BS EN 60947-4-3 EMCD: EN 60947-4-3 / EMC: BS EN 60947-4-3 cURus: UL508 Recognised (E80573), NRNT2, NRNT8 CSA: C22.2 No.14, (204075) VDE: VDE0660-109
UL short circuit current rating	65k Arms (refer to short circuit current section, Type 1 – UL508)

Electromagnetic compatibility (EMC) - Immunity

Electrostatic discharge (ESD)	EN/IEC 61000-4-2 8 kV air discharge, 4 kV contact (PC2)
Radiated radio frequency	EN/IEC 61000-4-3 10 V/m, from 80 MHz to 1 GHz (PC1) 10 V/m, from 1.4 to 2 GHz (PC1) 3 V/m, from 2 to 2.7 GHz (PC1)
Electrical fast transient (burst)	EN/IEC 61000-4-4 Output: 2 kV, 5 kHz (PC1) Input: 1 kV, 5 kHz (PC1)
Conducted radio frequency	EN/IEC 61000-4-6 10 V/m, from 0.15 to 80 MHz (PC1)
Electrical surge	EN/IEC 61000-4-5 Output, line to line: 2 kV (PC2) Output, line to earth: 2 kV (PC2) Input, line to line: 1kV (PC2) Input, line to earth: 2kV (PC2)
Voltage dips	EN/IEC 61000-4-11 0% for 0.5, 1 cycle (PC2) 40% for 10 cycles (PC2) 70% for 25 cycles (PC2) 80% for 250 cycles (PC2)
Voltage interruptions	EN/IEC 61000-4-11 0% for 5000 ms (PC2)

Electromagnetic compatibility (EMC) - Emissions

Radio interference field emission (radiated)	EN/IEC 55011 Class A: from 30 to 1000 MHz
Radio interference voltage emissions (conducted)	EN/IEC 55011 Class A: from 0.15 to 30 MHz (External filter may be required)

Note:

- Control input lines must be installed together to maintain products' susceptibility to Radio Frequency interference.
- The control terminals A1, A2 (RAM1A..A..G) shall be supplied by a secondary circuit where power is limited by a transformer, rectifier, voltage divider, or similar device that derives power from a primary circuit, and where the short-circuit limit between conductors of the secondary circuit or between conductors and ground is 1500 VA or less. The short-circuit volt ampere limit is the product of the open circuit voltage and the short circuit ampere.
- Performance Criteria 1 (PC1): No degradation of performance or loss of function is allowed when the product is operated as intended.
- Performance Criteria 2 (PC2): During the test, degradation of performance or partial loss of function is allowed. However when the test is complete the product should return operating as intended by itself.
- Performance Criteria 3 (PC3): Temporary loss of function is allowed, provided the function can be restored by manual operation of the controls.

Environmental specifications

Operating temperature	-40°C to +80°C (-40°F to +176°F)
Storage temperature	-40°C to +100°C (-40°F to +212 °F)
Relative humidity	95% non-condensing @ 40°C
Pollution degree	2
Installation altitude	0-1000 m. Above 1000 m derate linearly by 1% of FLC per 100 m up to a maximum of 2000 m
Vibration resistance	5g / axis (2-100Hz, IEC 60068-2-6, EN 50155, EN 61373)
Impact resistance	15/11 g/ms (EN 50155, EN 61373)
EU RoHS compliant	Yes
China RoHS	

The declaration in this section is prepared in compliance with People's Republic of China Electronic Industry Standard SJ/T11364-2014: Marking for the Restricted Use of Hazardous Substances in Electronic and Electrical Products.

Part Name	Toxic or Harardous Substances and Elements					
	Lead (Pb)	Mercury (Hg)	Cadmium (Cd)	Hexavalent Chromium (Cr(VI))	Polybrominated biphenyls (PBB)	Polybrominated diphenyl ethers (PBDE)
Power Unit Assembly	x	o	o	o	o	o

O: Indicates that said hazardous substance contained in homogeneous materials for this part are below the limit requirement of GB/T 26572.

X: Indicates that said hazardous substance contained in one of the homogeneous materials used for this part is above the limit requirement of GB/T 26572.

这份申明根据中华人民共和国电子工业标准 SJ/T11364-2014：标注在电子电气产品中限定使用的有害物质

零件名称	有毒或有害物质与元素					
	铅 (Pb)	汞 (Hg)	镉 (Cd)	六价铬 (Cr(VI))	多溴化联苯 (PBB)	多溴联苯醚 (PBDE)
功率单元	x	o	o	o	o	o

O:此零件所有材料中含有的该有害物低于GB/T 26572的限定。

X: 此零件某种材料中含有的该有害物高于GB/T 26572的限定。

Short circuit protection

Protection Co-ordination, Type 1 vs Type 2:

Type 1 protection implies that after a short circuit, the device under test will no longer be in a functioning state. In Type 2 co-ordination the device under test will still be functional after the short circuit. In both cases, however the short circuit has to be interrupted. The fuse between enclosure and supply shall not open. The door or cover of the enclosure shall not be blown open. There shall be no damage to conductors or terminals and the conductors shall not separate from terminals. there shall be no breakage or cracking of insulating bases to the extent that the integrity of the mounting of live parts is impaired. Discharge of parts or any risk of fire shall not occur.

The product variants listed in the table hereunder are suitable for use on a circuit capable of delivering not more than 65,000 Arms Symmetrical Amperes, 600Volts maximum when protected by fuses. Tests at 65,000A were performed with Class J, fast acting: please refer to the table below for maximum allowed ampere rating of the fuse. Use fuses only.

Protection co-ordination Type 1 according to UL 508				
Part No.	Prospective short circuit current [kArms]	Max fuse size [A]	Class	Voltage [VAC]
RAM1..25	65	30	J or CC	Max. 600
RAM1..50.., 51		30 20	J HSJ20(Mersen)*	
RAM1..100		80 60	J HSJ60(Mersen)*	
RAM1..125		125 60	J HSJ60(Mersen)*	

Protection co-ordination Type 2 (IEC/EN 60947-4-3)				
Part No.	Prospective short circuit current [kArms]	Ferraz Shawmut (Mersen)		Max. voltage [VAC]
		Max fuse size [A]	Part number	
RAM1.23..25	10	25	6.9gRB 10-25	660
RAM1.60..25		20	6.9gRB 10-20	660
RAM1.23..50, 51		50	6.9zz CP gRC 14x51/50	660
RAM1.60..50, 51		50	6.9zz CP gRC 22x58/50	660
RAM1.60.100		80	6.9zz CP gRC 22x58/80	660
RAM1.60.125		125	6.921 CP URGD 27x60/125	660

zz = 00, without fuse trip indication,
zz = 21, with fuse trip indication.

Protection co-ordination Type 2 with Miniature Circuit Breakers (M.C.B.s)				
Solid State Relay type	ABB Model no. for Z - type M. C. B. (rated current)	ABB Model no. for B - type M. C. B. (rated current)	Wire cross sectional area [mm ²]	Minimum length of Cu wire conductor [m]*
RAM..25	S201 - Z4 (4A)	S201 - B2 (2A)	1.0	21.0
			1.0	21.0
			1.5	31.5
RAM..50 RAM..51	S201 - Z10 (10A)	S201-B4 (4A)	1.0	7.6
			1.5	11.4
			2.5	19.0
	S201 - Z16 (16A)	S201-B6 (6A)	1.0	5.2
			1.5	7.8
			2.5	13.0
			4.0	20.8
	S201 - Z20 (20A)	S201-B10 (10A)	1.5	12.6
			2.5	21.0
	S201 - Z25 (25A)	S201-B13 (13A)	2.5	25.0
4.0			40.0	
S202 - Z25 (25A)	S202-B13 (13A)	2.5	19.0	
		4.0	30.4	
RAM..100	S201 - Z20 (20A)	S201-B10 (10A)	1.5	4.2
			2.5	7.0
			4.0	11.2
	S201 - Z32 (32A)	S201-B16 (16A)	2.5	13.0
			4.0	20.8
			6.0	31.2
	S202 - Z20 (20A)	S202-B10 (10A)	1.5	1.8
			2.5	3.0
			4.0	4.8
	S202 - Z32 (32A)	S202-B16 (16A)	2.5	5.0
			4.0	8.0
			6.0	12.0
10.0			20.0	
S202 - Z50 (50A)	S202-B25 (25A)	4.0	14.8	
		6.0	22.2	
		10.0	37.0	
RAM..125	S201-Z50 (50A)	S201-B25 (25A)	4.0	4.8
			6.0	7.2
			10.0	12.0
			16.0	19.2
	S201-Z63 (63A)	S201-B32 (32A)	6.0	7.2
			10.0	12.0
			16.0	19.2

4. Between MCB and Load (including return path which goes back to the mains).

Note: A prospective current of 6 kA and a 230 / 400 V power supply is assumed for the above suggested specifications. For cables with different cross section than those mentioned above please consult Carlo Gavazzi's Technical Support Group.

S201 models refer to 1-pole M.C.B., S202 models refer to 2-poles M.C.B.

Dimensions

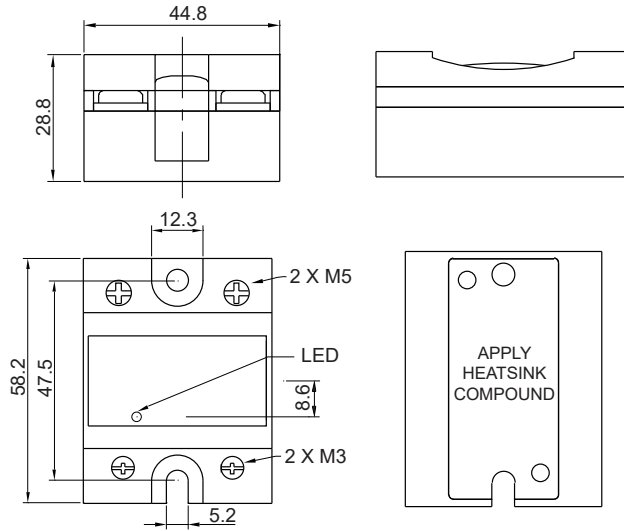

Dimensions in mm.
Tolerances ± 0.5 mm.

Connection diagram

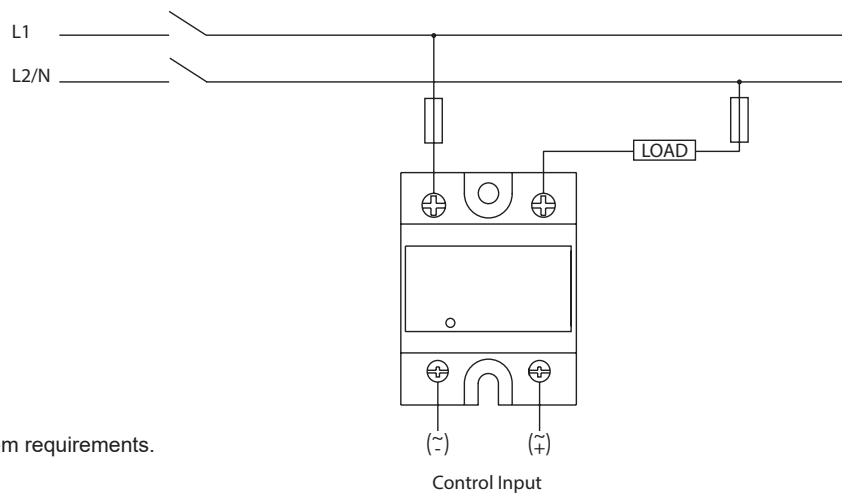

* Depends on system requirements.

Functional diagram

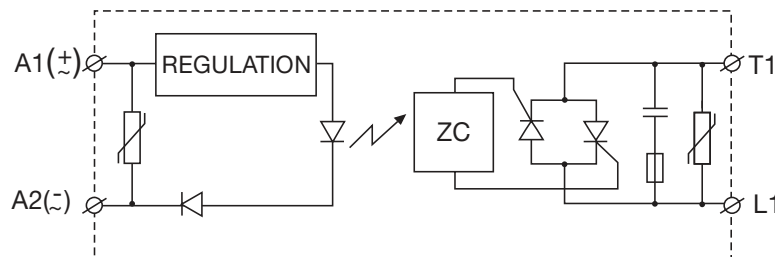

* Varistor across input applies to AC control versions only.

Connection Specifications

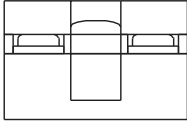
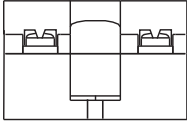
	1/L2, 2/T1		A1+, A2-	
				
Mounting screws (SSR to heatsink)	M5, not provided with SSR (refer to SRWKITM5X10MM in the Compatible components section)			
Mounting torque (SSR to heatsink)	1.5 - 2.0 Nm (13.3 - 17.7 lb-in)			
Connection type	M5 screw with captivated washer		M3 screw with captivated washer	
Stripping length	12 mm		8 mm	
Rigid (solid & stranded) UL/CSA rated data	1 x 2.5 – 6.0 mm ² 1 x 14 – 10 AWG	2x 2.5 – 6.0 mm ² 2x 14 – 10 AWG	1x 0.5 – 2.5 mm ² 1x 18 – 12 AWG	2x 0.5 - 2.5 mm ² 2x 18 - 12 AWG
Flexible with end sleeve	1 x 1.0 – 4.0 mm ² 1 x 18 – 12 AWG	2x 1.0 – 2.5 mm ² 2x 2.5 – 4.0 mm ² 2x 18 – 14 AWG 2x 14 – 12 AWG	1x 0.5 – 2.5 mm ² 1x 18 – 12 AWG	2x 0.5 - 2.5 mm ² 2x 18 - 12 AWG
Flexible without end sleeve	2x 1.0 – 6.0 mm ² 2x 18 – 10 AWG	2x 1.0 – 2.5 mm ² 2x 2.5 – 6.0 mm ² 2x 18 – 14 AWG 2x 14 – 10 AWG	1x 1.0 – 6.0mm ² 1x 18 –10 AWG	
Torque specifications	Posidrive bit 2 2.4 Nm (21.2 lb-in)		Posidrive bit 1 0.5 Nm (4.4 lb-in)	
Aperture for termination lug (fork or ring)	12 mm		7.5 mm	



COPYRIGHT ©2022
 Content subject to change.
 Download the PDF: <https://gavazziautomation.com>