

XCKML121

Limit switch, Limit switches XC Standard, XCKML, thermoplastic roller lever plunger, 2x(1NC+1NO), snap, Pg13

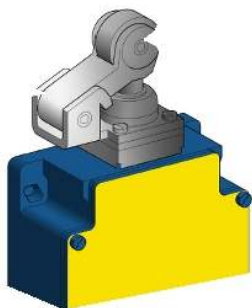

Main

Range of Product	Telemecanique Limit switches XC Standard
Series name	Standard format
Product or Component Type	Limit switch
Device short name	XCKML
Body type	Fixed
Head type	Plunger head
Material	Metal
Body Material	Zamak
Fixing Mode	By the body
Movement of operating head	Linear
Type of operator	Spring return roller lever plunger thermoplastic
Type of approach	Lateral approach, 1 direction
Cable entry	3 entries tapped for Pg 13.5 cable gland 0.35... 0.47 in (9...12 mm)
Number of poles	4
Contacts type and composition	2 x (1 NC + 1 NO)
Contact operation	Snap action

Complementary

Switch actuation	By 30° cam
Electrical connection	Screw-clamp terminals 1 x 0.34...2 x 1.5 mm ²
Contacts insulation form	Zb
Number of steps	1
Positive opening	With
Positive opening minimum force	50 N
Minimum force for tripping	8 N
Minimum actuation speed	0.01 m/min
Maximum actuation speed	4.92 ft/s (1.5 m/s)
[I _{th}] conventional enclosed thermal current	10 A AC
[U _i] rated insulation voltage	300 VUL 508 500 V 3)IEC 60947-1 300 VCSA C22.2 No 14
Maximum resistance across terminals	25 MOhm IEC 60255-7 category 3
[U _{imp}] rated impulse withstand voltage	6 KV IEC 60664 6 kV IEC 60947-1
Electrical durability	5000000 Cycles, DC-13, inductive, 120 V, 4 W 60 cyc/mn 0.5 IEC 60947-5-1 appendix C 5000000 Cycles, DC-13, inductive, 24 V, 7 W 60 cyc/mn 0.5 IEC 60947-5-1 appendix C 5000000 cycles, DC-13, inductive, 48 V, 10 W 60 cyc/mn 0.5 IEC 60947-5-1 appendix C
Mechanical durability	3000000 cycles
Width	3.03 in (77 mm)
Height	3.19 in (81 mm)
Depth	1.42 in (36 mm)

The information provided in this documentation contains general descriptions and/or technical characteristics of the performance of the products contained herein. This documentation is not intended as a substitute for and is not to be used for determining suitability or reliability of these products for specific user applications. It is the duty of any such user or integrator to perform the appropriate and complete risk analysis, evaluation and testing of the products with respect to the relevant specific application or use thereof. Neither Schneider Electric Industries SAS nor any of its affiliates or subsidiaries shall be responsible or liable for misuse of the information contained herein.

Net Weight	0.99 lb(US) (0.45 kg)
Terminals description ISO n°1	(13-14)NO (21-22)NC

Environment

Shock resistance	50 gn 11 ms EN/IEC 60068-2-27
Vibration resistance	25 gn 10...500 Hz)EN/IEC 60068-2-6
IP degree of protection	IP66 conforming to EN/IEC 60529
IK degree of protection	IK05 EN 50102
Electrical shock protection class	Class I IEC 61140 Class I NF C 20-030
Ambient Air Temperature for Operation	-13...158 °F (-25...70 °C)
Ambient Air Temperature for Storage	-40...158 °F (-40...70 °C)
Protective treatment	TC
Product Certifications	UL CSA
Standards	UL 508 EN 60947-5-1 IEC 60204-1 IEC 60947-5-1 CSA C22.2 No 14 EN 60204-1





Ordering and shipping details

Category	22416-LIMIT SWITCHES,IEC,XCKL
Discount Schedule	T
GTIN	3389110161267
Nbr. of units in pkg.	1
Package weight(Lbs)	16.86 oz (478.0 g)
Returnability	No
Country of origin	FR

Packing Units

Unit Type of Package 1	PCE
Package 1 Height	2.09 in (5.3 cm)
Package 1 width	3.54 in (9 cm)
Package 1 Length	5.91 in (15 cm)
Unit Type of Package 2	S03
Number of Units in Package 2	20
Package 2 Weight	22.56 lb(US) (10.233 kg)
Package 2 Height	11.81 in (30 cm)
Package 2 width	11.81 in (30 cm)
Package 2 Length	15.75 in (40 cm)

Offer Sustainability

Sustainable offer status	Green Premium product
California proposition 65	WARNING: This product can expose you to chemicals including: Diisononyl phthalate (DINP), which is known to the State of California to cause cancer, and Di-isodecyl phthalate (DIDP), which is known to the State of California to cause birth defects or other reproductive harm. For more information go to www.P65Warnings.ca.gov
REACH Regulation	 REACH Declaration
EU RoHS Directive	Pro-active compliance (Product out of EU RoHS legal scope)  EU RoHS Declaration
Mercury free	Yes
RoHS exemption information	 Yes
Environmental Disclosure	 Product Environmental Profile

Contractual warranty

Warranty	18 months
----------	-----------

Dimensions

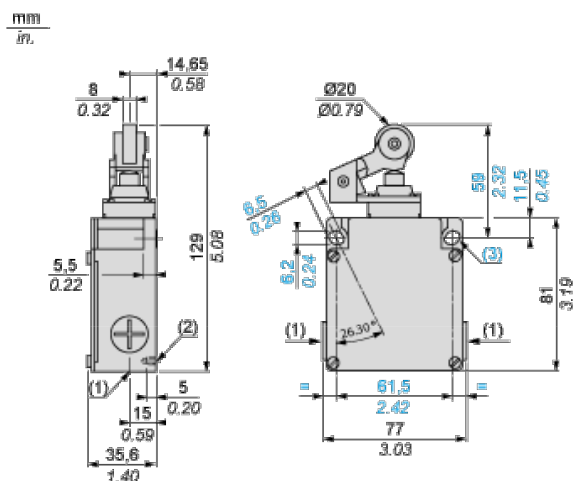

- (1) 3 tapped entries for Pg 13.5 cable gland
- (2) 2 centring holes $\text{Ø } 3.9 \pm 0.2$, for cover fixing holes alignment.
- Ø: 2 elongated holes 6.2×6.5 , inclined at $26^\circ 30'$ to the vertical axis, for M5 screws.

Mounting with Cable Entry

Position of Cable Gland

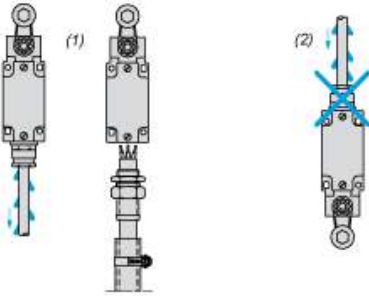

- (1) Recommended
- (2) To be avoided

Wiring Diagram

2 x 2-pole NC + NO Snap Action

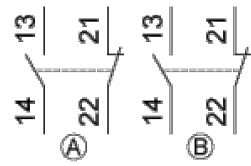

Characteristics of Actuation

Switch Actuation by 30° Cam

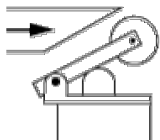

Functionnal Diagram

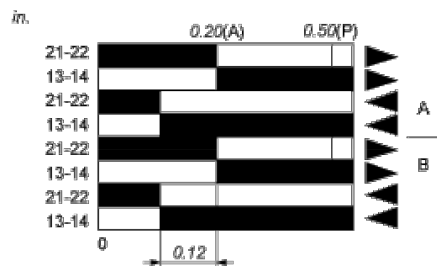
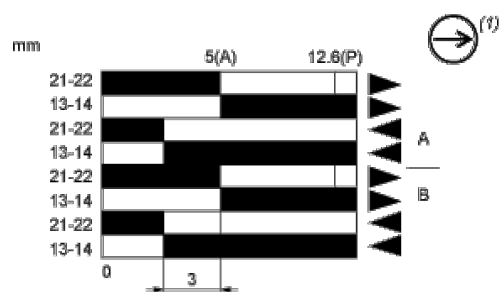

- (2)
- (3)
- ▲ (4)
- ◀ (5)

- (P) Positive opening point
- (A) Cam displacement
- (1) NC contact with positive opening operation
- (2) Closed
- (3) Open
- (4) Tripping
- (5) Resetting