

REV.	DESCRIPTION	DATE
A	RELEASE	2016.06.08

RoHS

MATERIAL&FINISH
 Insulator: PBT Glass Fiber (UL94V-0)
 Contact Material: Terminal Brass.
 Shell Spec.
 Contact Plating : Terminal Gold-Plated Over Nickel.
 Shell Nickel.

SPECIFICATIONS

Current Rating :1A AC, DC
 Voltage Rating : 250V AC, DC
 Temperature Range:-40° C To+105° C
 Contact Resistance:20MΩ Max
 Insulation Resistance:1000MΩ Min
 Withstanding Voltage:500V AC/Min

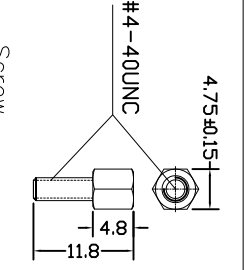
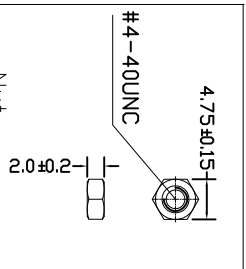
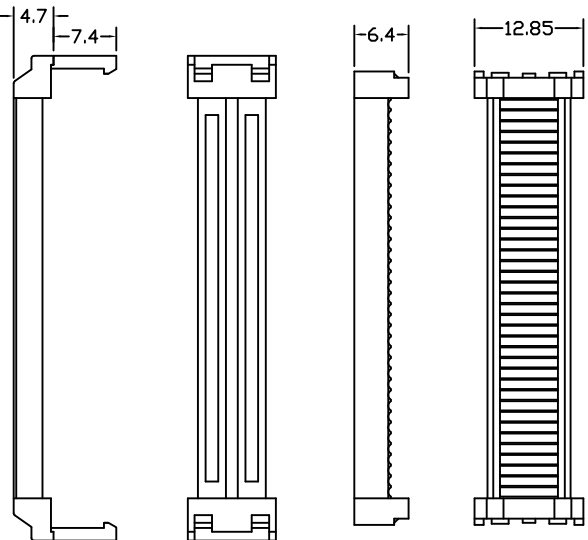
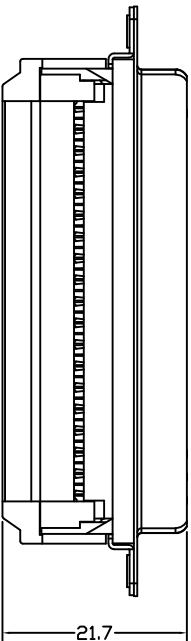
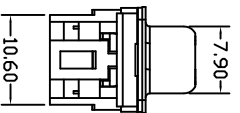
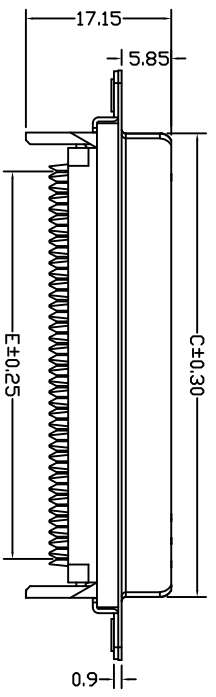
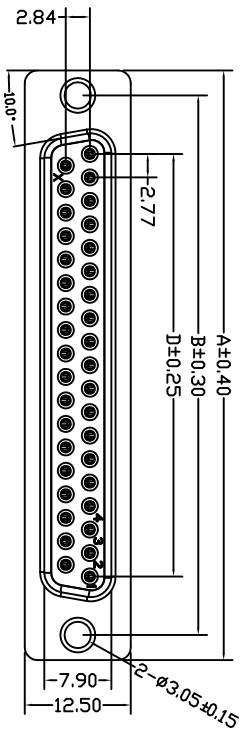

NUMBER OF POSITIONS	DIMENSION				
	A	B	C	D	E
9	30.80	25.00	16.35	11.08	10.16
15	39.14	33.30	24.75	19.39	17.78
25	53.05	47.04	38.35	33.24	30.48
37	69.32	63.50	54.75	49.86	45.72

UNLESS TOLERANCE		DRAW BY	Cnc Tech,LLC	
GENERAL	ANGLE	DESIGN BY	Part NO.	400F0-XX-1-004S
X ± 0.30	X° ± 3.0°	CHECK BY	APPROVE BY	
.X ± 0.20	.X° ± 2.0°	SCALE	SHEET	
.XX ± 0.15	.XX° ± 1.0°	1:1	1/1	
.XXX ± 0.08	.XXX ± 0.5°	UNIT	MM	

