

# XCNT2102P16

Limit switch, Limit switches XC Standard, XCNT, plastic roller plunger, 1NC+1 NO, snap, M16



## Main

Range of Product	Telemecanique Limit switches XC Standard
Series name	Standard format
Product or Component Type	Limit switch
Device short name	XCNT
Sensor design	Compact
Body type	Fixed
Head type	Plunger head
Material	Plastic
Body Material	Plastic
Head material	Plastic
Fixing Mode	By the body
Movement of operating head	Linear
Type of operator	Spring return roller plunger plastic
Type of approach	Lateral approach, 2 directions
Cable entry	2 entries tapped for M16 x 1.5 cable gland 0.28... 0.51 in (7...13 mm)
Number of poles	2
Contacts type and composition	1 NC + 1 NO
Contact operation	Snap action

## Complementary

Switch actuation	By 30° cam
Electrical connection	Screw-clamp open terminals 1 x 0.34...2 x 1.5 mm <sup>2</sup>
Contacts insulation form	Zb
Positive opening minimum force	20 N
Minimum force for tripping	12 N
Maximum actuation speed	0.98 ft/s (0.3 m/s)
Contact code designation	A300, AC-15 (U <sub>e</sub> = 240 V), I <sub>e</sub> = 3 A 10 A EN/IEC 60947-5-1 appendix A R300, DC-13 (U <sub>e</sub> = 250 V), I <sub>e</sub> = 0.1 A EN/IEC 60947-5-1 appendix A
[U <sub>i</sub> ] rated insulation voltage	300 VUL 508 500 V 3)IEC 60947-1 300 VCSA C22.2 No 14
[U <sub>imp</sub> ] rated impulse withstand voltage	6 kV IEC 60664 6 kV IEC 60947-1
Short-circuit protection	10 A cartridge fuse gG
Mechanical durability	10000000 cycles
Width	2.31 in (58.8 mm)
Height	3.06 in (77.6 mm)
Depth	1.20 in (30.5 mm)

The information provided in this documentation contains general descriptions and/or technical characteristics of the performance of the products contained herein. This documentation is not intended as a substitute for and is not to be used for determining suitability or reliability of these products for specific user applications. It is the duty of any such user or integrator to perform the appropriate and complete risk analysis, evaluation and testing of the products with respect to the relevant specific application or use thereof. Neither Schneider Electric Industries SAS nor any of its affiliates or subsidiaries shall be responsible or liable for misuse of the information contained herein.

## Environment

Shock resistance	50 gn 11 ms IEC 60068-2-27
Vibration resistance	25 gn 10...500 Hz)IEC 60068-2-6
IP degree of protection	IP65 conforming to IEC 60529
IK degree of protection	IK04 EN 50102
Electrical shock protection class	Class II IEC 61140 Class II NF C 20-030
Ambient Air Temperature for Operation	-13...158 °F (-25...70 °C)
Ambient Air Temperature for Storage	-40...158 °F (-40...70 °C)
Protective treatment	TC
Product Certifications	CCC UL CSA
Standards	UL 508 CSA C22.2 No 14 EN/IEC 60204-1 EN/IEC 60947-5-1



## Ordering and shipping details



Category	22435-LIMIT SWITCHES,TYPE XCM
Discount Schedule	T
GTIN	3389119047180
Nbr. of units in pkg.	1
Package weight(Lbs)	3.32 oz (94.0 g)
Returnability	No
Country of origin	ID

## Packing Units

Unit Type of Package 1	PCE
Package 1 Height	1.22 in (3.1 cm)
Package 1 width	2.28 in (5.8 cm)
Package 1 Length	3.07 in (7.8 cm)
Unit Type of Package 2	BB1
Number of Units in Package 2	10
Package 2 Weight	33.23 oz (942.0 g)
Package 2 Height	4.33 in (11 cm)
Package 2 width	5.12 in (13 cm)
Package 2 Length	6.54 in (16.6 cm)
Unit Type of Package 3	S03
Number of Units in Package 3	80
Package 3 Weight	18.06 lb(US) (8.194 kg)
Package 3 Height	11.81 in (30 cm)
Package 3 width	11.81 in (30 cm)
Package 3 Length	15.75 in (40 cm)

## Offer Sustainability

Sustainable offer status	Green Premium product
California proposition 65	WARNING: This product can expose you to chemicals including: Diisononyl phthalate (DINP), which is known to the State of California to cause cancer, and Di-isodecyl phthalate (DIDP), which is known to the State of California to cause birth defects or other reproductive harm. For more information go to <a href="http://www.P65Warnings.ca.gov">www.P65Warnings.ca.gov</a>
REACH Regulation	 <a href="#">REACH Declaration</a>
EU RoHS Directive	Pro-active compliance (Product out of EU RoHS legal scope)  <a href="#">EU RoHS Declaration</a>
Mercury free	Yes

RoHS exemption information	 <a href="#">Yes</a>
Environmental Disclosure	 <a href="#">Product Environmental Profile</a>
Circularity Profile	 <a href="#">End Of Life Information</a>

### Contractual warranty

Warranty	18 months
----------	-----------

Dimensions

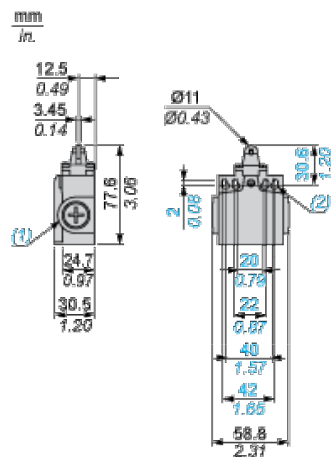

- (1) 2 tapped entry for M16 x 1.5
- (2) Ø: 4 elongated holes Ø 4.3 x 6.3

---

Mounting with Cable Entry

---

Position of Cable Gland



- (1) Recommended
- (2) To be avoided

---

Wiring Diagram

---

2-pole NC + NO Snap Action

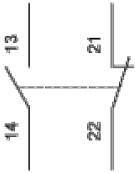

Characteristics of Actuation

Switch Actuation by 30° Cam

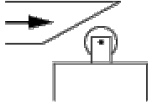

Functionnal Diagram

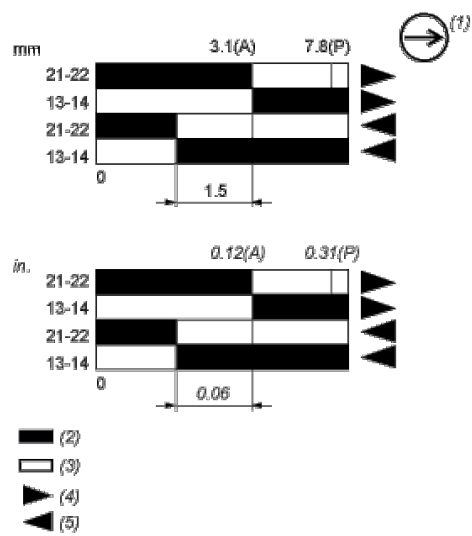

- (P) Positive opening point
- (A) Cam displacement
- (1) NC contact with positive opening operation
- (2) Closed
- (3) Open
- (4) Tripping
- (5) Resetting