



HA-2600, HA-2602 HA-2605

Wideband, High Impedance
Operational Amplifiers

March 1993

Features

- Wide Bandwidth 12MHz
- High Input Impedance 500MΩ
- Low Input Bias Current 1nA
- Low Input Offset Current 1nA
- Low Input Offset Voltage 0.5mV
- High Gain 150kV/V
- High Slew Rate 7V/μs
- Output Short Circuit Protection
- Unity Gain Stable

Applications

- Video Amplifier
- Pulse Amplifier
- Audio Amplifiers and Filters
- High-Q Active Filters
- High-Speed Comparators
- Low Distortion Oscillators

Ordering Information

PART NUMBER	TEMPERATURE RANGE	PACKAGE
HA2-2600-2	-55°C to +125°C	8 Pin Can
HA2-2602-2	-55°C to +125°C	8 Pin Can
HA2-2605-5	0°C to +75°C	8 Pin Can
HA3-2605-5	0°C to +75°C	8 Lead Plastic DIP
HA4P2605-5	0°C to +75°C	20 Lead PLCC
HA7-2600-2	-55°C to +125°C	8 Lead Ceramic DIP
HA7-2602-2	-55°C to +125°C	8 Lead Ceramic DIP
HA7-2605-5	0°C to +75°C	8 Lead Ceramic DIP
HA9P2605-5	0°C to +75°C	8 Lead SOIC
HA9P2605-9	-40°C to +85°C	8 Lead SOIC

Description

HA-2600/2602/2605 are internally compensated bipolar operational amplifiers that feature very high input impedance (500MΩ, HA-2600) coupled with wideband AC performance. The high resistance of the input stage is complemented by low offset voltage (0.5mV, HA-2600) and low bias and offset current (1nA, HA-2600) to facilitate accurate signal processing. Input offset can be reduced further by means of an external nulling potentiometer. 12MHz unity gain bandwidth, 7V/μs slew rate and 150kV/V open-loop gain enables HA-2600/2602/2605 to perform high-gain amplification of fast, wideband signals. These dynamic characteristics, coupled with fast settling times, make these amplifiers ideally suited to pulse amplification designs as well as high frequency (e.g. video) applications. The frequency response of the amplifier can be tailored to exact design requirements by means of an external bandwidth control capacitor.

In addition to its application in pulse and video amplifier designs, HA-2600/2602/2605 are particularly suited to other high performance designs such as high-gain low distortion audio amplifiers, high-Q and wideband active filters and high-speed comparators. For more information, please refer to Application Note 515.

The HA-2600 and HA-2602 are offered as /883 Military Grade; product and data sheets are available upon request.

Pinouts

HA-2600/02 (CDIP)
HA-2605 (PDIP, CDIP, SOIC)
TOP VIEW

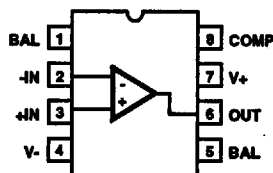

HA-2600/02/05
(TO-99 METAL CAN)
TOP VIEW

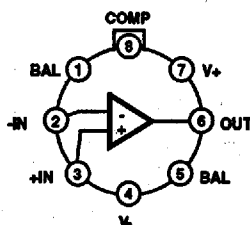

HA-2605, (PLCC)
TOP VIEW

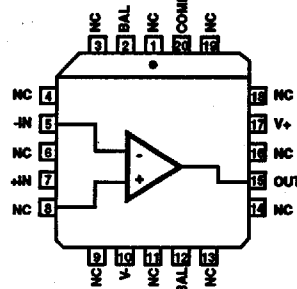

CAUTION: These devices are sensitive to electrostatic discharge. Users should follow proper I.C. Handling Procedures.

Copyright © Harris Corporation 1993

2-368

File Number 2902.1

Absolute Maximum Ratings (Note 13)

Supply Voltage Between V+ and V- Terminals.....	45.0V
Differential Input Voltage.....	12.0V
Peak Output Current.....	Full Short Circuit Protection
Junction Temperature.....	+175°C
Junction Temperature (Plastic Package).....	+150°C
Lead Temperature (Soldering 10 Sec.).....	+300°C

Operating Conditions

Operating Temperature Range	
HA-2600/HA-2602-2.....	-55°C ≤ T _A ≤ +125°C
HA-2605-5.....	0°C ≤ T _A ≤ +75°C
HA-2605-9.....	-40°C ≤ T _A ≤ +85°C
Storage Temperature Range.....	-65°C ≤ T _A ≤ +150°C

CAUTION: Stresses above those listed in "Absolute Maximum Ratings" may cause permanent damage to the device. This is a stress only rating and operation of the device at these or any other conditions above those indicated in the operational sections of this specification is not implied.

Electrical Specifications V_S = ±15V D.C., Unless Otherwise Specified

PARAMETER	TEMP	HA-2600-2			HA-2602-2			HA-2605-5			(NOTE 15) HA-2605-9	UNITS
		MIN	TYP	MAX	MIN	TYP	MAX	MIN	TYP	MAX	MAX	
INPUT CHARACTERISTICS												
Offset Voltage	+25°C	-	0.5	4	-	3	5	-	3	5	5	mV
	Full	-	2	6	-	-	7	-	-	7	7	mV
Average Offset Voltage Drift	Full	-	5	-	-	5	-	-	5	-	-	µV/°C
Bias Current	+25°C	-	1	10	-	15	25	-	5	25	25	nA
	Full	-	10	30	-	-	60	-	-	40	70	nA
Offset Current	+25°C	-	1	10	-	5	25	-	5	25	25	nA
	Full	-	5	30	-	-	60	-	-	40	70	nA
Differential Input Resistance (Note 10)	+25°C	100	500	-	40	300	-	40	300	-	-	MΩ
Input Noise Voltage Density f = 1kHz	+25°C	-	11	-	-	11	-	-	11	-	-	nV/√Hz
Input Noise Current Density f = 1kHz	+25°C	-	0.16	-	-	0.16	-	-	0.16	-	-	pA/√Hz
Common Mode Range	Full	±11	±12	-	±11	±12	-	±11	±12	-	-	V
TRANSFER CHARACTERISTICS												
Large Signal Voltage Gain (Notes 1, 4)	+25°C	100	150	-	80	150	-	80	150	-	-	kV/V
	Full	70	-	-	60	-	-	70	-	-	-	kV/V
Common Mode Rejection Ratio (Note 2)	Full	80	100	-	74	100	-	74	100	-	-	dB
Minimum Stable Gain	+25°C	1	-	-	1	-	-	1	-	-	-	V/V
Gain Bandwidth Product (Note 3)	+25°C	-	12	-	-	12	-	-	12	-	-	MHz
OUTPUT CHARACTERISTICS												
Output Voltage Swing (Note 1)	Full	±10	±12	-	±10	±12	-	±10	±12	-	-	V
Output Current (Note 4)	+25°C	±15	±22	-	±10	±18	-	±10	±18	-	-	mA
Full Power Bandwidth (Notes 4, 11)	+25°C	50	75	-	50	75	-	50	75	-	-	kHz

2
OPERATIONAL AMPLIFIERS

Electrical Specifications $V_S = \pm 15V$ D.C., Unless Otherwise Specified (Continued)

PARAMETER	TEMP	HA-2600-2			HA-2602-2			HA-2605-5			(NOTE 15) HA-2605-9	UNITS
		MIN	TYP	MAX	MIN	TYP	MAX	MIN	TYP	MAX	MAX	
TRANSIENT RESPONSE (Note 8)												
Rise Time (Notes 1, 5, 6 & 7)	+25°C	-	30	60	-	30	60	-	30	60	60	ns
Overshoot (Notes 1, 5, 6 & 7)	+25°C	-	25	40	-	25	40	-	25	40	40	%
Slew Rate (Notes 1, 5, 7 & 12)	+25°C	±4	±7	-	±4	±7	-	±4	±7	-	-	V/μs
Settling Time (Notes 1, 5 & 14)	+25°C	-	1.5	-	-	1.5	-	-	1.5	-	-	μs
POWER SUPPLY CHARACTERISTICS												
Supply Current	+25°C	-	3	3.7	-	3	4	-	3	4	4	mA
Power Supply Rejection Ratio (Note 9)	Full	80	90	-	74	90	-	74	90	-	-	dB

NOTES:

1. $R_L = 2k\Omega$
2. $V_{CM} = \pm 10V$
3. $V_{OUT} < 90mV$
4. $V_{OUT} = \pm 10V$
5. $C_L = 100pF$
6. $V_{OUT} = \pm 200mV$
7. $A_V = +1$
8. See Transient Response Test Circuits and Waveforms
9. $\Delta V_S = \pm 5V$
10. This parameter value guaranteed by design calculations.
11. Full Power Bandwidth guaranteed by slew rate measurement: $FPBW = \frac{\text{Slew Rate}}{2\pi V_{PEAK}}$
12. $V_{OUT} = \pm 5V$
13. Absolute Maximum Ratings are limiting values applied individually beyond which the serviceability of the circuit may be impaired. Functional operation under any of these conditions is not necessarily implied.
14. Settling time is characterized at $A_V = -1$ to 0.1% of a 10 Volt step.
15. Typical and minimum specifications for -9 are identical to those of -5.

Schematic Diagram

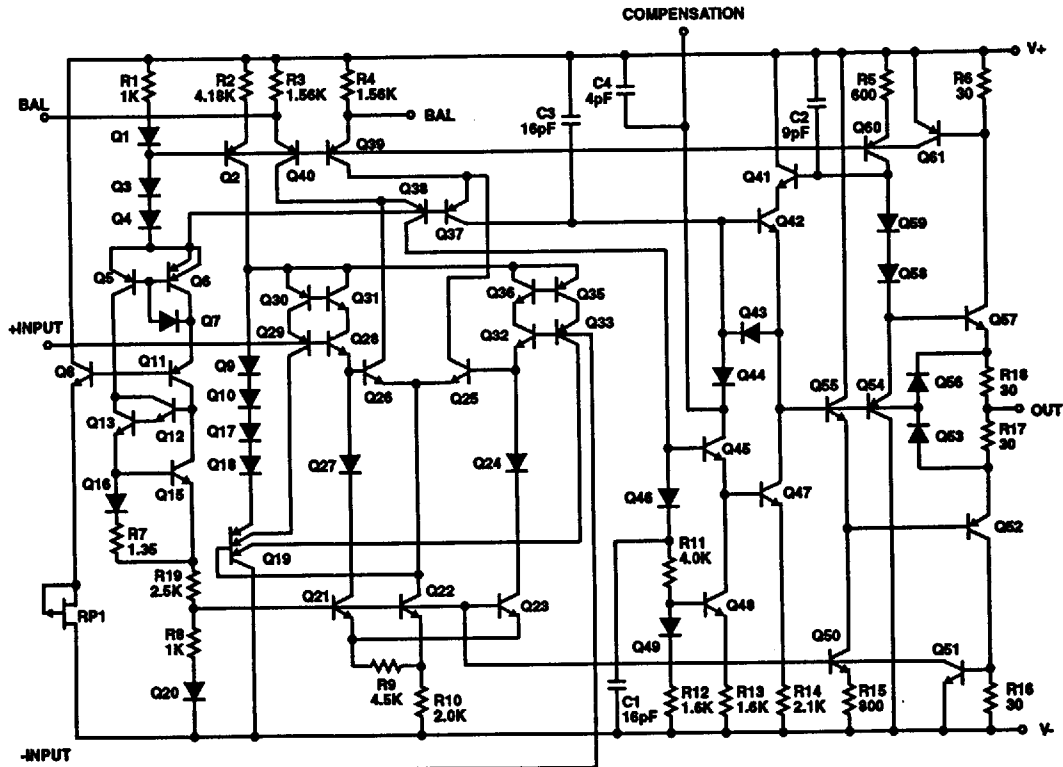

Die Characteristics

Transistor Count	140	Thermal Constants (°C/W)	θ_{JA}	θ_{JC}
Die Dimensions	69 x 56 x 19 mils	Metal Can	117	36
Substrate Potential	Unbiased	Plastic DIP	96	34
		Ceramic DIP	115	36
		SOIC	157	43
		PLCC	74	33

Test Circuits

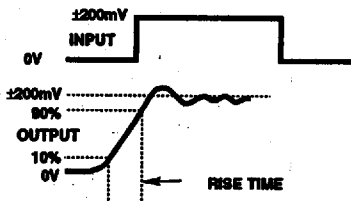

FIGURE 1. TRANSIENT RESPONSE

NOTE: Measured on both positive and negative transitions from 0V to +200mV and 0V to -200mV at the output.

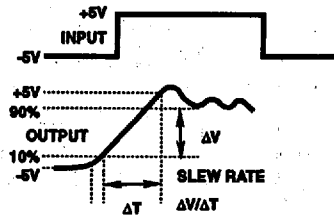

FIGURE 2. SLEW RATE

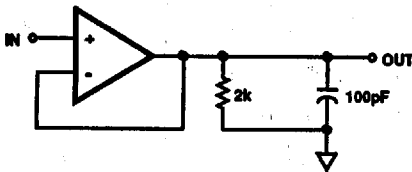

FIGURE 3. SLEW RATE AND TRANSIENT RESPONSE

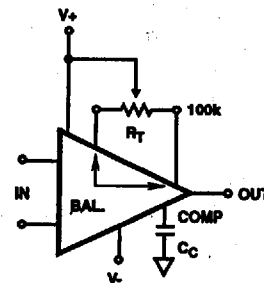

FIGURE 4. SUGGESTED V_{OS} ADJUSTMENT AND COMPENSATION HOOK UP

NOTE: Tested offset adjustment range is $IV_{OS} + 1mV$ minimum referred to output. Typical ranges are $\pm 10mV$ with $R_T = 100k\Omega$

Typical Performance Curves $V_S = \pm 15VDC$, $T_A = +25^\circ C$, Unless Otherwise Specified

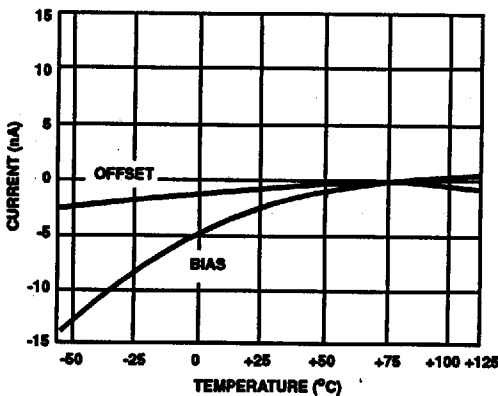

FIGURE 5. INPUT BIAS CURRENT AND OFFSET CURRENT vs TEMPERATURE

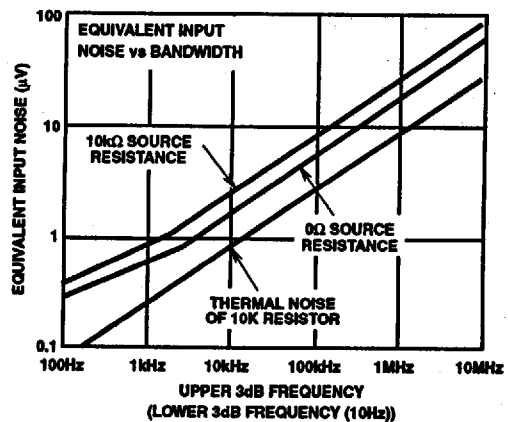

FIGURE 6. BROADBAND NOISE CHARACTERISTICS

Typical Performance Curves $V_S = \pm 15\text{VDC}$, $T_A = +25^\circ\text{C}$, Unless Otherwise Specified (Continued)

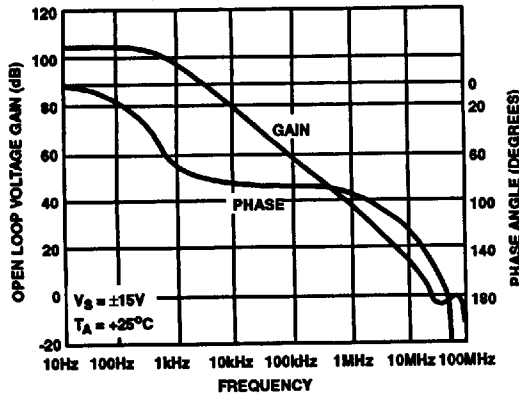

FIGURE 7. OPEN LOOP FREQUENCY AND PHASE RESPONSE

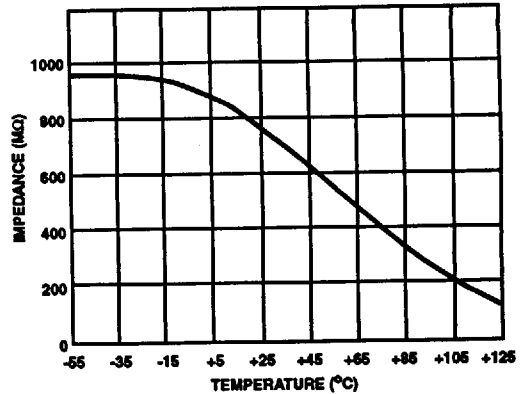

FIGURE 8. INPUT IMPEDANCE vs TEMPERATURE (100Hz)

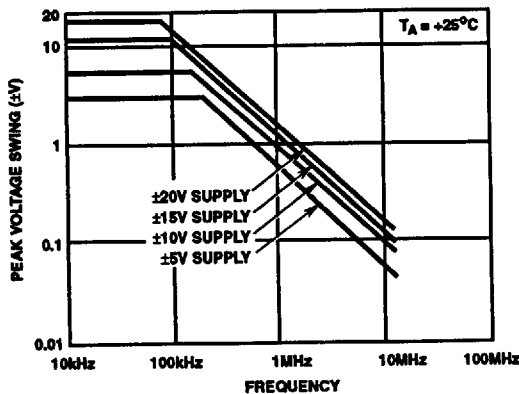

FIGURE 9. OUTPUT VOLTAGE SWING vs FREQUENCY

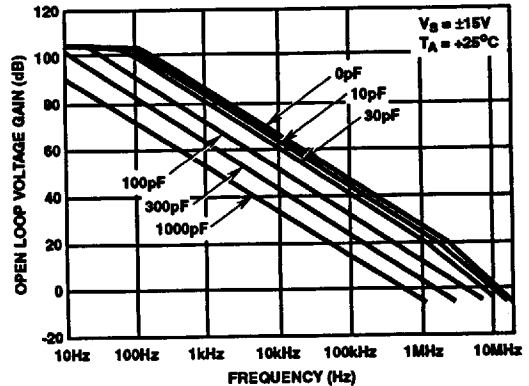

FIGURE 10. OPEN LOOP FREQUENCY RESPONSE FOR VARIOUS VALUES OF CAPACITORS FROM COMPENSATION PIN TO GROUND

NOTE: External compensation components are not required for stability, but may be added to reduce bandwidth if desired. If External Compensation is used, also connect 100pF capacitor from output to ground.

Typical Performance Curves $V_S = \pm 15VDC$, $T_A = +25^\circ C$, Unless Otherwise Specified (Continued)

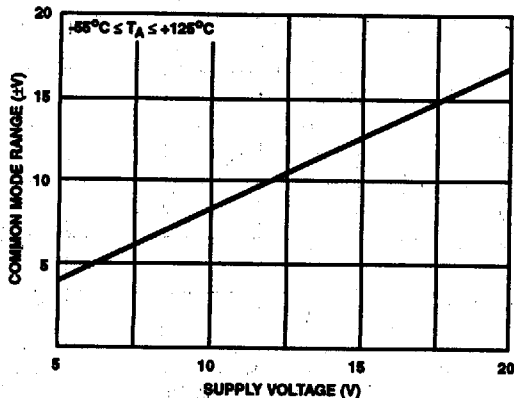

FIGURE 11. COMMON MODE VOLTAGE RANGE vs SUPPLY VOLTAGE

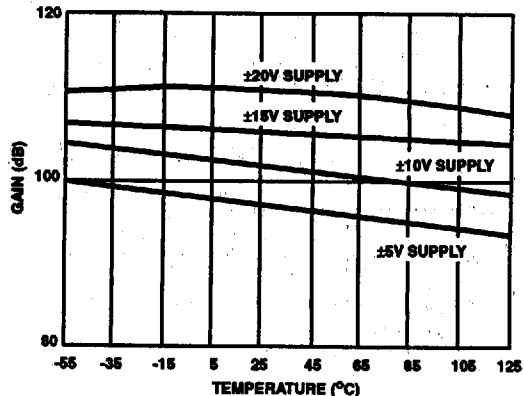

FIGURE 12. OPEN LOOP VOLTAGE GAIN vs TEMPERATURE

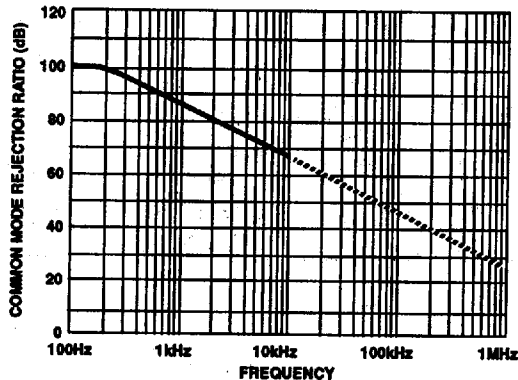

FIGURE 13. COMMON MODE REJECTION RATIO vs FREQUENCY

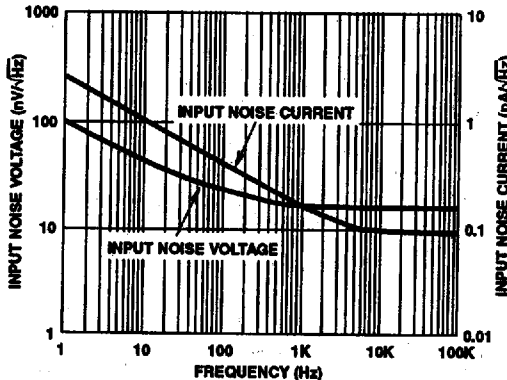
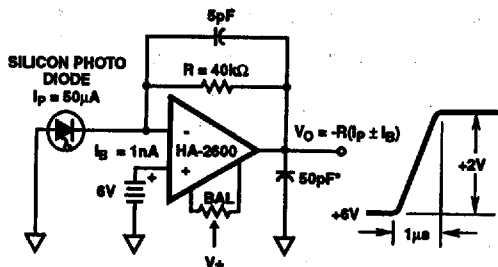

FIGURE 14. NOISE DENSITY vs FREQUENCY

Typical Applications



FEATURES:

1. Constant cell voltage
2. Minimum bias current error

FIGURE 15. PHOTO CURRENT TO VOLTAGE CONVERTER

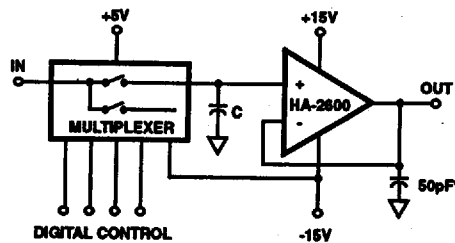

$$\text{DRIFT RATE} = \frac{I_{\text{BIAS}}}{C}$$

If $C = 1000pF$
Then $\text{DRIFT} = 0.01V/\mu s$ Max

FIGURE 16. SAMPLE AND HOLD

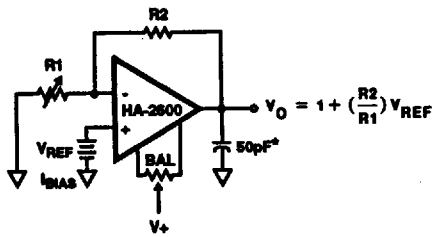
Typical Applications (Continued)**FEATURES:**

1. Minimum bias current in reference cell
2. Short Circuit Protection

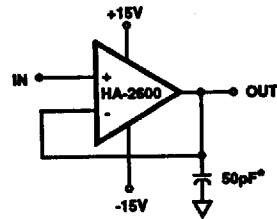
FIGURE 17. REFERENCE VOLTAGE AMPLIFIER $Z_{IN} = 10^{12}\Omega$ Min. $Z_{OUT} = 0.01\Omega$ Max.Slew Rate = $4V/\mu s$ Min.

B.W. = 12MHz. Typ.

Output Swing = $\pm 10V$ Min. to 50kHz**FIGURE 18. VOLTAGE FOLLOWER**

* A small load capacitance is recommended in all applications where practical to prevent possible high frequency oscillations resulting from external wiring parasitics. Capacitance up to 100pF has negligible effect on the bandwidth or slew rate.