

SERIES: TBP04R12-500 | **DESCRIPTION:** TERMINAL BLOCK

FEATURES

- 2~24 poles
- horizontal orientation
- 5.0 mm pitch
- UL and CE safety approvals



SPECIFICATIONS

parameter	conditions/description	min	typ	max	units
rated voltage (per contact)	UL			300	V
	IEC			400	V
rated current (per contact)	UL			15	A
	IEC			10	A
withstanding voltage	for 1 minute		1600		Vac
surge voltage				4000	V
contact resistance				20	mΩ
insulation resistance	at 500 Vdc	500			MΩ
operating temperature		-40		105	°C
safety approvals	UL 1059, EN61984:2009				
flammability rating	UL94V-0				
RoHS	yes				

SOLDERABILITY

parameter	conditions/description	min	typ	max	units
wave soldering	for maximum 5 seconds		250		°C

PART NUMBER KEY

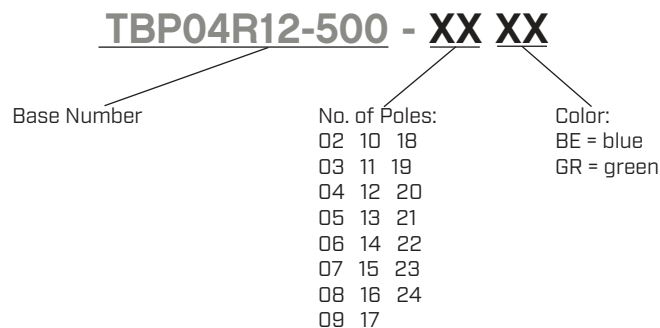

MECHANICAL DRAWING

units: mm
 tolerance:
 $X \leq 6.00$: ± 0.20 mm
 $6.00 < X \leq 10.00$: ± 0.30 mm
 $10.00 < X \leq 30.00$: ± 0.50 mm
 $30.00 < X \leq 60.00$: ± 0.70 mm
 $60.00 < X \leq 100.00$: ± 1.00 mm
 $100.00 < X \leq 160.00$: ± 1.30 mm
 $X > 160.00$: ± 1.60 mm
 unless otherwise noted

DESCRIPTION	MATERIAL	PLATING/COLOR
housing	PA66 [UL94V-0]	
contacts	copper alloy	tin

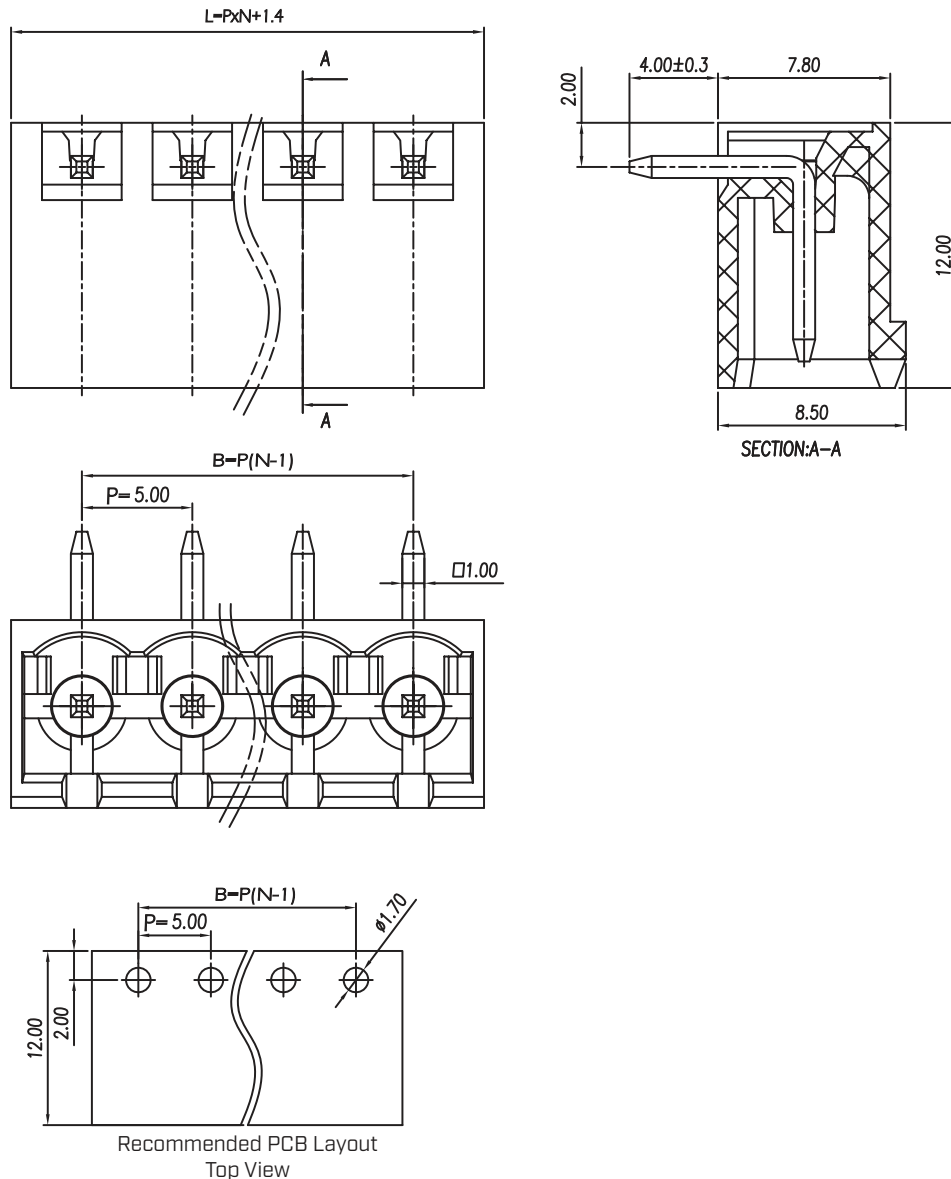

This series is constructed of single piece modules where L is the total length, P is the pitch, and N is the number of poles.

N	02	03	04	05	06	07	08	09	10	11	12	13
L	11.40	16.40	21.40	26.40	31.40	36.40	41.40	46.40	51.40	56.40	61.40	66.40
B	5.00	10.00	15.00	20.00	25.00	30.00	35.00	40.00	45.00	50.00	55.00	60.00
N	14	15	16	17	18	19	20	21	22	23	24	--
L	71.40	76.40	81.40	86.40	91.40	96.40	101.40	106.40	111.40	116.40	121.40	--
B	65.00	70.00	75.00	80.00	85.00	90.00	95.00	100.00	105.00	110.00	115.00	--

REVISION HISTORY

rev.	description	date
1.0	initial release	10/07/2021
1.01	logo, datasheet style update	08/11/2022

The revision history provided is for informational purposes only and is believed to be accurate.



CUI Devices offers a one (1) year limited warranty. Complete warranty information is listed on our website.

CUI Devices reserves the right to make changes to the product at any time without notice. Information provided by CUI Devices is believed to be accurate and reliable. However, no responsibility is assumed by CUI Devices for its use, nor for any infringements of patents or other rights of third parties which may result from its use.

CUI Devices products are not authorized or warranted for use as critical components in equipment that requires an extremely high level of reliability. A critical component is any component of a life support device or system whose failure to perform can be reasonably expected to cause the failure of the life support device or system, or to affect its safety or effectiveness.

cuidevices.com