

ENG. NO. SD-5547-NA  
EDP NO. #

MM DIMENSIONS IN METRIC DO NOT SCALE DRAWING

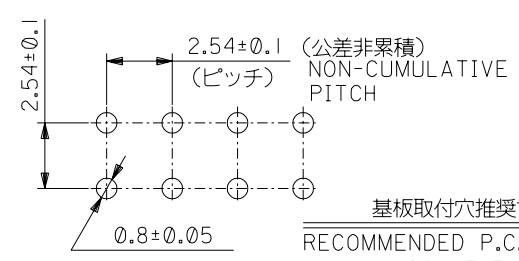
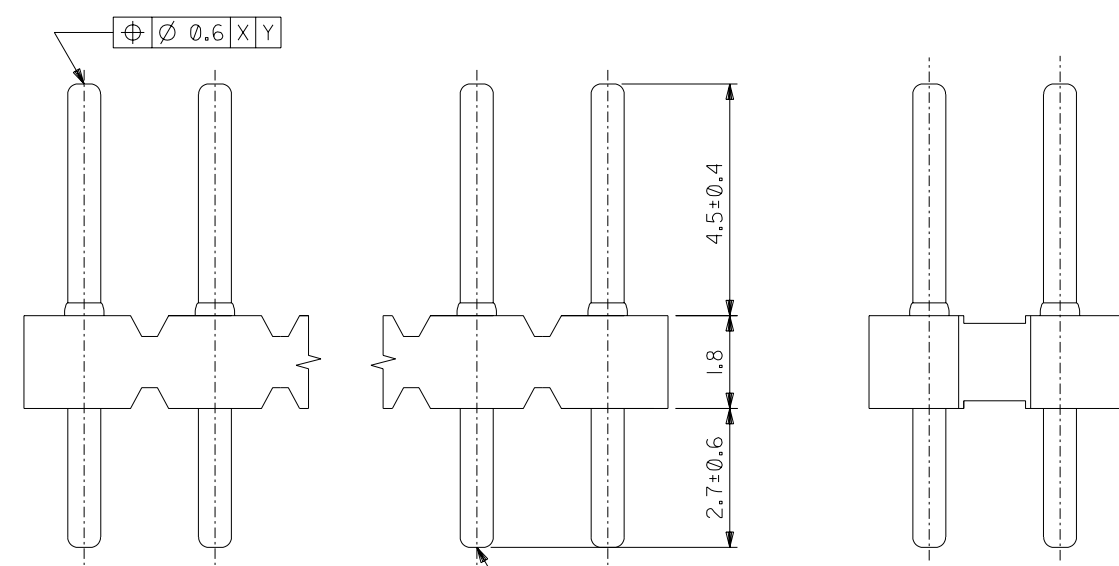
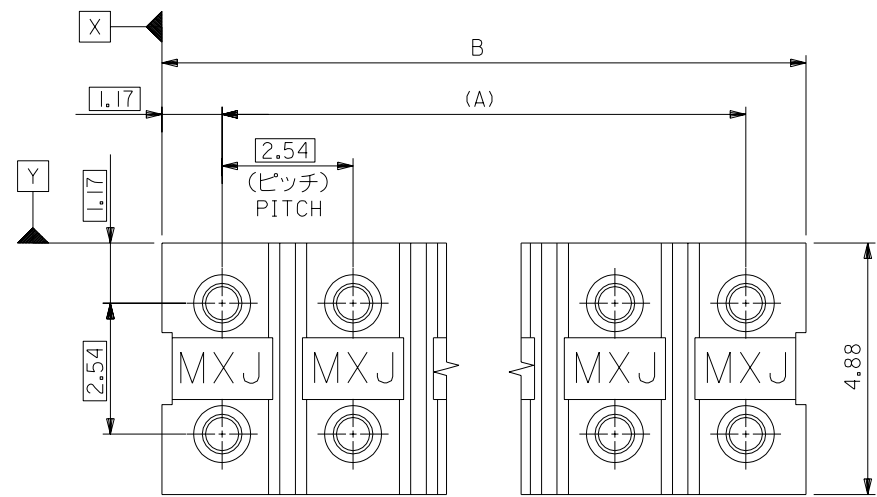

基板取付穴推奨寸法  
RECOMMENDED P.C.B. LAYOUT  
(SCALE 5-1)

注記:  
NOTES

1. 材料  
MATERIAL  
ピン : 黄銅 Ø0.64  
PIN : BRASS Ø0.64  
ウェハー : ガラス15%入りP.B.T. UL94V-0、黒  
WAFER : P.B.T. G.F.15% UL94V-0, BLACK
2. メッキ仕様  
PLATING  
錫メッキ  
Sn PLATING.
3. 2極は5547-NAを切断加工したものです。  
2 CIRCUITS TO BE MADE BY CUTTING  
5547-NA.

42.98	40.64	5547-34A	34
40.44	38.10	5547-32A	32
37.90	35.56	5547-30A	30
35.36	33.02	5547-28A	28
32.82	30.48	5547-26A	26
30.28	27.94	5547-24A	24
27.74	25.40	5547-22A	22
25.20	22.86	5547-20A	20
22.66	20.32	5547-18A	18
20.12	17.78	5547-16A	16
17.58	15.24	5547-14A	14
15.04	12.70	5547-12A	12
12.50	10.16	5547-10A	10
9.96	7.62	5547-08A	8
7.42	5.08	5547-06A	6
4.48	2.54	5547-04A	4
2.54 <sup>+0.5</sup> <sub>-0.2</sub>	—	5547-02A	2
B	(A)	ENG. No.	CKT.

角度 ANGLE	±3°	材料 MATERIAL	注記参照 SEE NOTES	molex MOLEX-JAPAN CO.,LTD. 日本モレックス株式会社
30以上 OVER	+0.3	仕上げ FINISH	注記参照 SEE NOTES	
10以上 OVER 30未満 UNDER	+0.25	適用電線範囲 WIRE RANGE	—	EDP. NO. #
10未満 UNDER	+0.2	被覆外径 INS. RANGE	—	ENG. NO. (SHEET 1 OF 2) REV B
一般公差 UNIT:mm GENERAL TOLERANCES	REVISION RECORD	記号 TR	変更内容 REVISION RECORD	DR. CHK. DATE
	B 再作図 REDRAWING (JD7026.0) K.A. M.S. 96/9/3	DRAWN BY	CHK'D BY	TITLE 名称 2.54 DUAL ROW MICRO SHUNT WAFER ASS'Y
	REVISION RECORD	APP'D BY	尺度 SCALE 10-1	

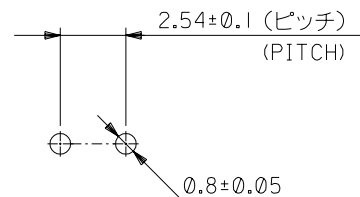
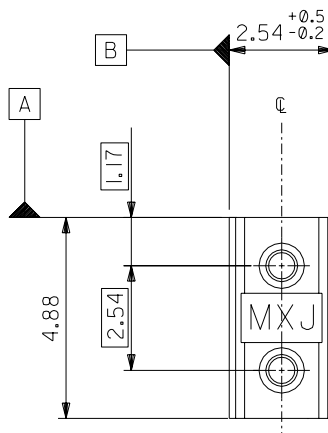
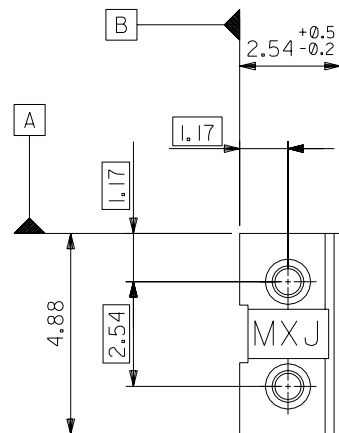

基板取付穴推奨寸法  
RECOMMENDED P.C.B. LAYOUT  
(SCALE: 5-1)

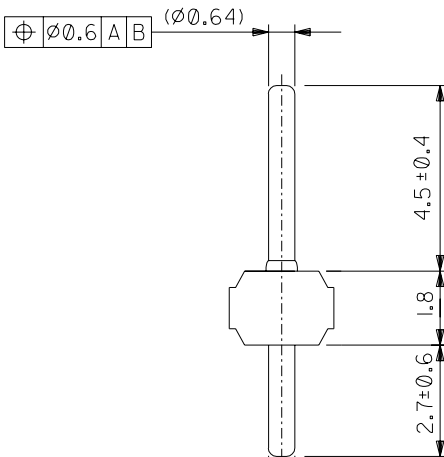
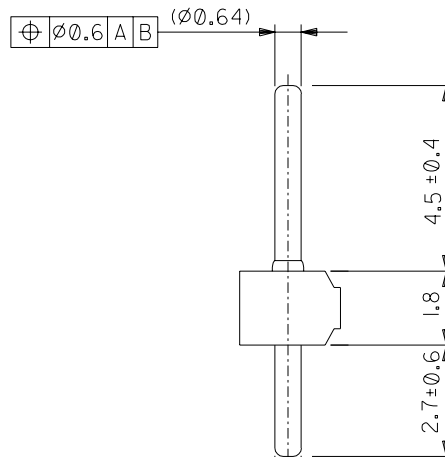

TYPE I

TYPE II

DIMENSIONS IN METRIC DO NOT SCALE DRAWING

材料 MATERIAL		注記参照 SEE NOTES		molex MOLEX-JAPAN CO.,LTD. 日本モレックス株式会社	
仕上げ FINISH		注記参照 SEE NOTES		REVISE ONLY ON CAD SYSTEM	
適用電線範囲 WIRE RANGE		— / —		TITLE 名称	
被覆外径 INS. RANGE		— / —		2.54 DUAL ROW MICRO SHUNT WAFER ASS'Y	
DRAWN BY '96/9/3		CHK'D BY '96/9/3		DWG. NO. (SHEET 2 OF 2) REV	
LTR		REVISION RECORD		SD-5547-NA B	
SHEET 1 OF 2 参照 SEE SHEET 1 OF 2 (JD7026)		DR. M.S.		SCALE 8-1	
一般公差 GENERAL TOLERANCES		記号 LTR		変更内容 REVISION RECORD	
角度 ANGLE		±3°		DR. DATE	
30 以上 OVER		±0.3		APP'D BY	
10 以上 30 未満 OVER UNDER		±0.25		R. Adachi	
10 未満 UNDER		±0.2		H. Sarao	

ZF 3:110.0036355547NAS2.DGN