

# CC3200MOD SimpleLink™ Microcontroller and Wi-Fi® Network Processor Module - LaunchPad Hardware

## User's Guide



Literature Number: SWRU397A  
December 2014—Revised August 2018

---



---



---

<b>1</b>	<b>Introduction</b> .....	<b>4</b>
1.1	CC3200MOD LaunchPad .....	4
1.2	Key Features.....	4
1.3	What's Included .....	5
1.4	FCC/IC Regulatory Compliance.....	5
<b>2</b>	<b>Hardware Description</b> .....	<b>6</b>
2.1	Block Diagram .....	7
2.2	Hardware Features.....	7
2.3	Connecting a BoosterPack.....	8
2.4	Jumpers, Switches and LEDs .....	8
2.5	Power.....	14
2.6	Measure CC3200MOD Current Drawn .....	16
2.7	RF Connections.....	18
2.8	Design Files .....	19
<b>3</b>	<b>Software Examples</b> .....	<b>20</b>
3.1	Development Environment Requirements.....	20
<b>4</b>	<b>Additional Resources</b> .....	<b>21</b>
4.1	LaunchPad Wiki.....	21
4.2	Information on the CC3200MOD .....	21
4.3	Download CCS, IAR.....	21
4.4	CC3200 Code Examples .....	21
4.5	CC3200 Application Notes .....	21
4.6	The TI E2E Community .....	21
	<b>Revision History</b> .....	<b>23</b>

## List of Figures

1	CC3200MOD LaunchPad EVM Overview .....	6
2	CC3200MOD LaunchPad Block Diagram .....	7
3	Pn-1 Marking on the CC3200MOD LaunchPad (White Triangle) .....	8
4	JTAG Headers .....	8
5	I2C Connections .....	9
6	UART Signals .....	10
7	SOP Jumpers .....	10
8	2x20 Pin Connector .....	14
9	Powering From USB .....	15
10	Battery Power .....	15
11	Measuring Low Power .....	16
12	Measuring Active Power .....	17
13	Radiated Testing Using Chip Antenna .....	18
14	Board Set for Conducted Testing .....	18

## List of Tables

1	JTAG Headers .....	8
2	Jumper Settings .....	9
3	Default I2C Addresses .....	9
4	Jumper Settings .....	9
5	UART Signals .....	10
6	SOP Lines .....	10
7	Miscellaneous Settings .....	11
8	Push Buttons .....	12
9	LEDs .....	13
10	Change Log .....	19

# **CC3200MOD SimpleLink™ Microcontroller and Wi-Fi® Network Processor Module - LaunchPad Hardware**

---

---

---

## **1 Introduction**

### **1.1 CC3200MOD LaunchPad**

Start your design with the CC3200 module LaunchPad (CC3200MODLAUNCHXL), which encapsulates the industry's first programmable wireless microcontroller (MCU) module with built-in Wi-Fi connectivity. Created for the Internet of Things (IoT), the SimpleLink CC3200MOD is a wireless MCU module that integrates an ARM Cortex-M4 MCU, allowing customers to develop an entire application using a single device. The CC3200MOD integrates all required system-level hardware components including clocks, SPI flash, RF switch, and all required passive components.

This document explains the various configurations of the CC3200MODLAUNCHXL, a low-cost evaluation platform which hosts the CC3200MOD. The module LaunchPad also features programmable user buttons, RGB LED for custom applications, temperature and accelerometer sensors, as well as onboard emulation for debugging. The LaunchPad stackable headers interface demonstrates how to expand the functionality of the CC3200MOD when interfacing with other peripherals on existing BoosterPack add-on boards, such as graphical displays, audio codec, antenna selection, environmental sensing, and more. The CC3200MODLAUNCHXL is provided as a complete platform solution including software, sample applications, tools, user and programming guides, reference designs, and the TI E2E™ support community. [Figure 1](#) shows a photo of the CC3200MODLAUNCHXL board.

Visit the [CC3200 Wiki page](#) for design resources and example projects.

---

**NOTE:** The antennas used for this transmitter must be installed to provide a separation distance of at least 20 cm from all persons, and must not be co-located or operating in conjunction with any other antenna or transmitter.

---

### **1.2 Key Features**

- FCC, IC, CE, and Wi-Fi® CERTIFIED™ modules, with ability to request certificate transfer for Wi-Fi Alliance members
- CC3200MOD, SimpleLink Wi-Fi, internet-on-a-chip™ module solution with integrated MCU
- 40-pin LaunchPad standard that leverages the BoosterPack ecosystem
- FTDI-based JTAG emulation with serial port for flash programming
- Two buttons and three LEDs for user interaction
- Backchannel universal asynchronous receiver/transmitter (UART) through USB to PC
- On-board chip antenna with U.FL for conducted testing
- On-board accelerometer and temperature sensor for out-of-box demo
- Micro USB connector for power and debug connections

### 1.3 **What's Included**

Kit Contents:

- CC3200MODLAUNCHXL development board
- Micro USB cable
- Quick Start guide

### 1.4 **FCC/IC Regulatory Compliance**

The CC3200 SimpleLink Wi-Fi and IoT solution with MCU LaunchPad hardware is FCC Part 15 and IC ICES-003 Class A compliant.

<sup>(1)</sup>

<sup>(1)</sup> SimpleLink is a trademark of Texas Instruments.

## 2 Hardware Description

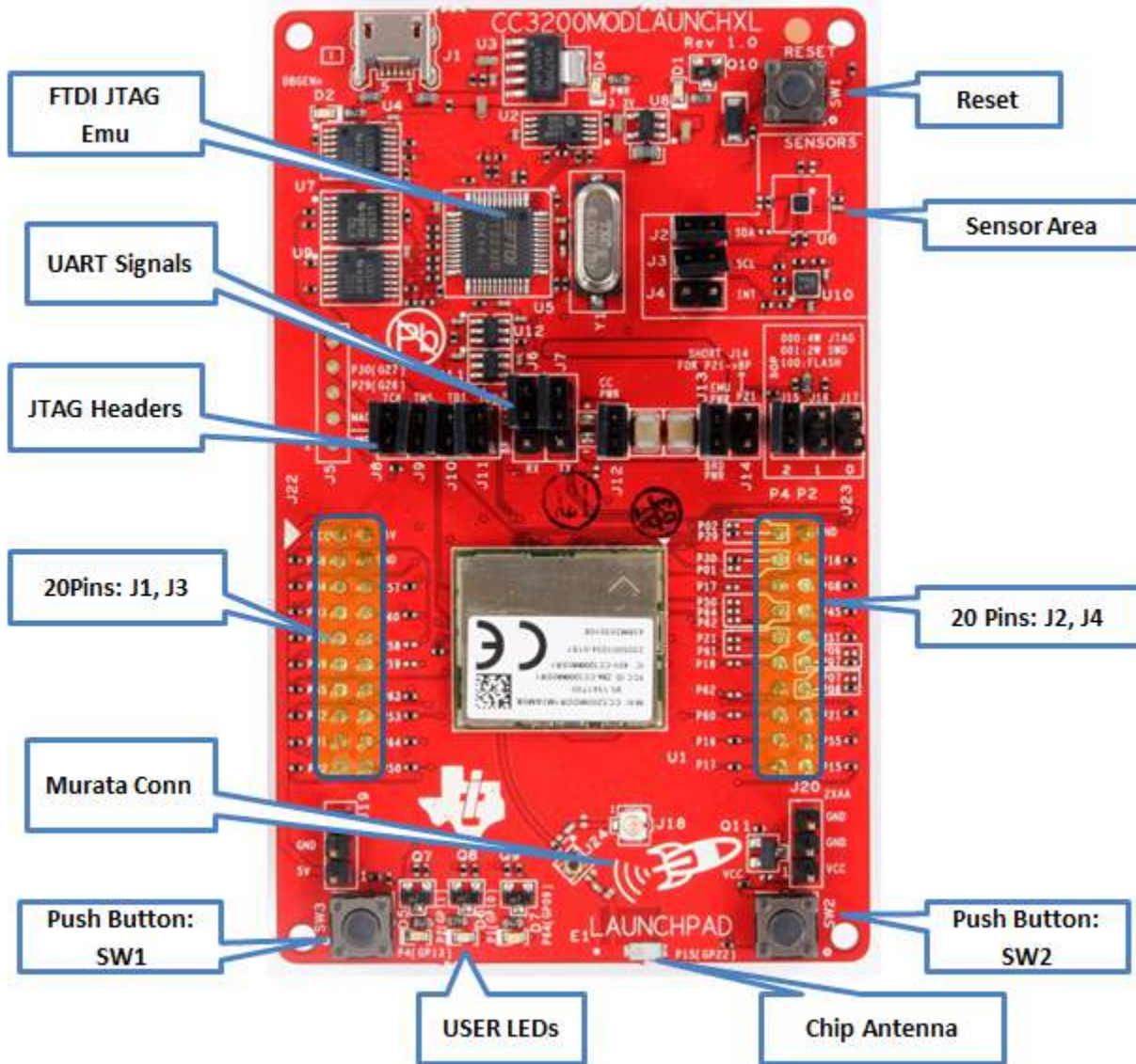

Figure 1. CC3200MOD LaunchPad EVM Overview

## 2.1 Block Diagram

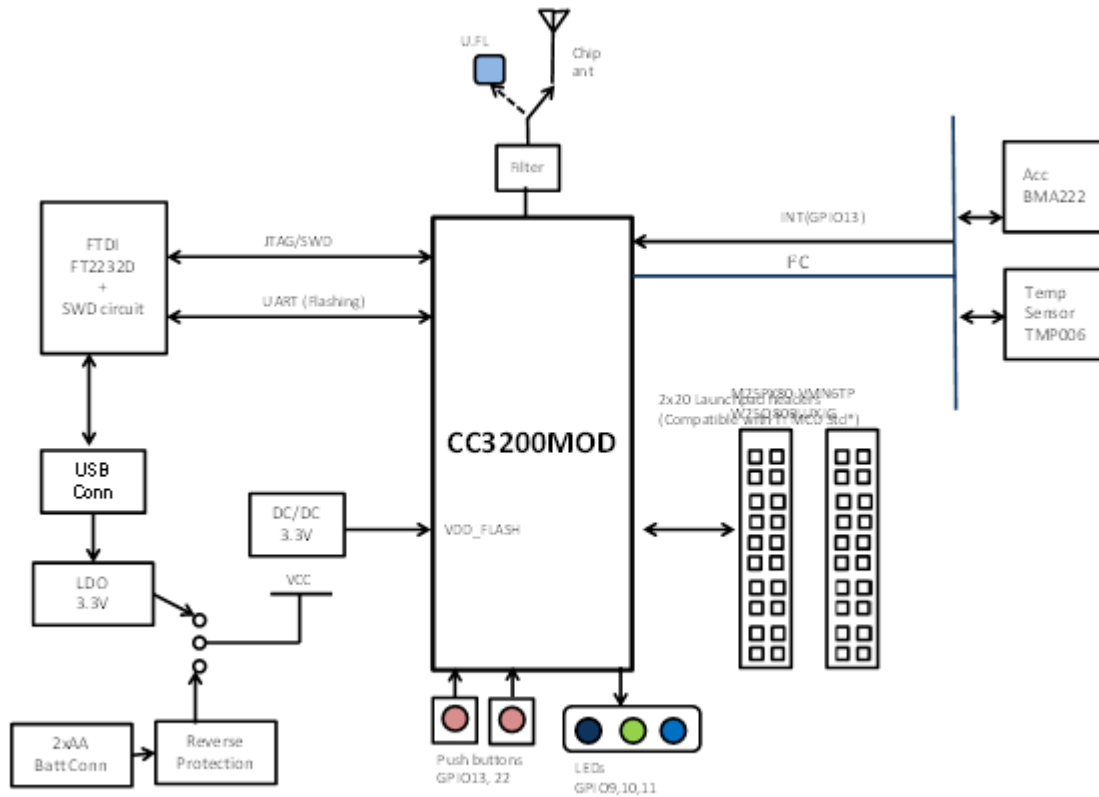

Figure 2. CC3200MOD LaunchPad Block Diagram

## 2.2 Hardware Features

- CC3200MOD, SimpleLink Wi-Fi, internet-on-a-chip module solution with integrated MCU40-pin LaunchPad standard that leverages the BoosterPack ecosystem
- FTDI-based JTAG emulation with serial port for flash programming
- Supports both 4-wire JTAG and 2-wire SWD
- Two buttons and three LEDs for user interaction
- Virtual COM port UART through USB on PC
- On-board chip antenna with U.FL for conducted testing
- On-board accelerometer and temperature sensor for out-of-box demo with option to isolate them from the inter-integrated circuit (I2C) bus
- Micro USB connector for power and debug connections
- Headers for current measurement and external JTAG connection
- Bus-powered device with no external power required for Wi-Fi
- Long range transmission with highly optimized antenna (200m typical in open air with a 6dBi antenna AP)
- Can be powered externally, with 2xAA or 2xAAA alkaline batteries working down to 2.3V typical (typ)

### 2.3 Connecting a BoosterPack

A compatible BoosterPack can be stacked on top of the LaunchPad using the 2x20 pin connectors. Note that the connectors do not have a “key” to prevent the misalignment of the pins or reverse connection. Ensure that the  $V_{cc}$  and 5V pins are aligned with the BoosterPack header pins. On the CC3200MOD LaunchPad, a small white triangle symbol is provided near Pin-1 (see Figure 3) to orient all BoosterPacks. This same marking, provided on compatible BoosterPacks, must be aligned before powering up the boards.



Figure 3. Pn-1 Marking on the CC3200MOD LaunchPad (White Triangle)

### 2.4 Jumpers, Switches and LEDs

#### 2.4.1 JTAG Headers

The headers are provided on the board to isolate the CC3200MOD device from the mounted FTDI JTAG emulator. These jumpers are shorted by default when the board is shipped from TI. To connect an external emulator, remove these jumpers and place the external emulator on the pins closer to the CC3200MOD device.



Figure 4. JTAG Headers

Table 1. JTAG Headers

Reference	Usage	Comments
J8 (TCK) <sup>(1)</sup>	JTAG	Short : Routes the on-board emulator to the CC3200MOD.
J9 (TMS) <sup>(1)</sup>		
J10 (TDI)		Open: Isolates the on-board emulator from the CC3200MOD.
J11 (TDO)		

<sup>(1)</sup> For the SWD mode, only TCK and TMS need to be shorted to the CC3200MOD.

When a battery is used, disconnect all JTAG headers to prevent any reverse leakage current.

#### 2.4.2 I2C Connections

The board features an accelerometer and a temperature sensor for the out-of-box demo. These are connected to the I2C bus and can be isolated using the jumpers provided.



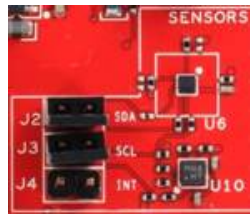

Figure 5. I2C Connections

By removing J2 and J3, the accelerometer and the temperature sensors are isolated from the I2C bus. Note that this also removes any pull-up resistor from the I2C bus.

#### 2.4.2.1 Jumper Settings

Table 2. Jumper Settings

Reference	Usage	Comments
J2	I2C SDA	Short : Connect the CC3200MOD I2C bus to the on-board sensors with pull-up Open : Isolate the sensors from the CC3200MOD
J3	I2C SCL	Short : Connect the CC3200MOD I2C bus to the on-board sensors with pull-up Open : Isolate the sensors from the CC3200MOD
J4	INT	Short : Connect the accelerometer interrupt to the CC3200 on GPIO13

#### 2.4.2.2 Default I2C Address

Table 3. Default I2C Addresses

Sensor Type	Ref	Part Number	Slave Address
Temp sensor	U6	TMP008	0x41
Accelerometer	U10	BMA222	0x18

#### 2.4.3 Power Connections

The board can be powered by using the on-board micro USB connector. An on-board LDO provides 3.3 V for the CC3200MOD and the rest of the board to operate. This supply can be isolated from the LDO using the jumpers on the board.

Table 4. Jumper Settings

Reference	Usage	Comments
J12	Current measurement	Measures the current flowing into the CC3200 device.
J13	Board power	Short: Supply the board power from the on-board LDO. Open: Supply the board power from the J20 (battery connector)
J19	5 V power	5 V output from the USB VBUS (has a diode drop of up to 0.4 V)
J20	3.3 V power input	Can be used to power the board from an external 2XAA battery pack. It has in-built reverse voltage protection to prevent the battery from being plugged in the reverse manner.

### 2.4.4 UART Signals

The board supports a USB-based virtual COM port, which is used on the FTDI device FT2232D. There are two ports on the FT2232: the first port is dedicated for the emulation (JTAG/SWD), and the second port is used for the virtual COM port. The UART can also be routed to the 20-pin connector and the selection is performed using jumpers on the board.

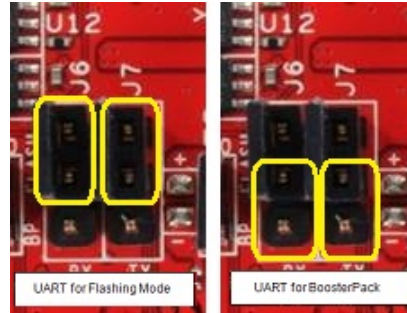

Figure 6. UART Signals

Table 5. UART Signals

Reference	Usage	Comments
J6, J7	UART for Flash programming	Short 1-2: Route the signals to the 20 pin connector. Short 2-3: Route the signals to the FTDI for Flash programming.

### 2.4.5 Sense on Power

The CC3200MOD can be set to operate in three different modes based on the state of the Sense on Power (SOP) lines. These are pins 21, 34, and 35 on the CC3200MOD device. The state of the device is described in [Table 6](#).

Table 6. SOP Lines

Usage	Comments
SOP[2:0]	100 = Flash programming 000 = Functional mode + 4 Wire JTAG 001 = Functional mode + 2 Wire JTAG



Note: SOP[2:0] corresponds to J15, J16, and J17, in the LaunchPad schematic design.





Figure 7. SOP Jumpers

**2.4.6 Other Miscellaneous**



**Table 7. Miscellaneous Settings**

Reference	Usage	Comments	
J4	Accelerometer Interrupt	Short = Route the Accelerometer sensor interrupt to the GPIO_13 Open = Isolates the Interrupt to the GPIO_13	
J5	Debug Header	To observe the Network Processor (NWP), MAC Logs.	
J14	SOP2 Isolation	Isolate SOP2 (GPIO_25) from the 20 pin connector	

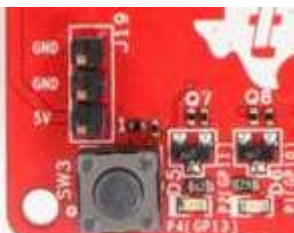
**2.4.7 Push Buttons and LEDs**
**Table 8. Push Buttons**

Reference	Usage	Comments	
SW1	RESET	This is used to RESET the CC3200MOD device. This signal is also output on the 20-pin connector to RESET any external BoosterPack which may be stacked.	
SW2	GPIO_22	When pushed, the GPIO_22 will be pulled to VCC.	
SW3	GPIO_13	When pushed, the GPIO_13 will be pulled to VCC.	

**Table 9. LEDs**

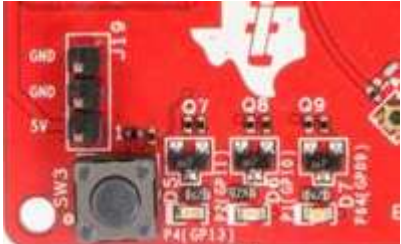
Reference	Color	Usage	Comments	
D1	Yellow	nRESET	This LED is used to indicate the state of nRESET pin. If this LED is glowing, the device is functional.	
D2	Green	Debug	This LED glows whenever the debugging is enabled over the JTAG.	
D4	Red	Power	Indicates when the 3.3 V power is supplied to the board.	
D5	Green	GPIO_11 <sup>(1)</sup>	Glows when the GPIO is logic-1	
D6	Yellow	GPIO_10 <sup>(1)</sup>	Glows when the GPIO is logic-1	
D7	Red	GPIO_09	Glows when the GPIO is logic-1	

<sup>(1)</sup> GPIO\_10 and GPIO\_11 are used as I2C also. So whenever the pull-ups are enabled, the LEDs would glow.

### 2.4.8 2x20 Pin Connector Assignment

The signal assignment on the 2x20 pin connector is shown in Figure 8. The P1-Pn naming convention is used for 2x20 pin connectors only.

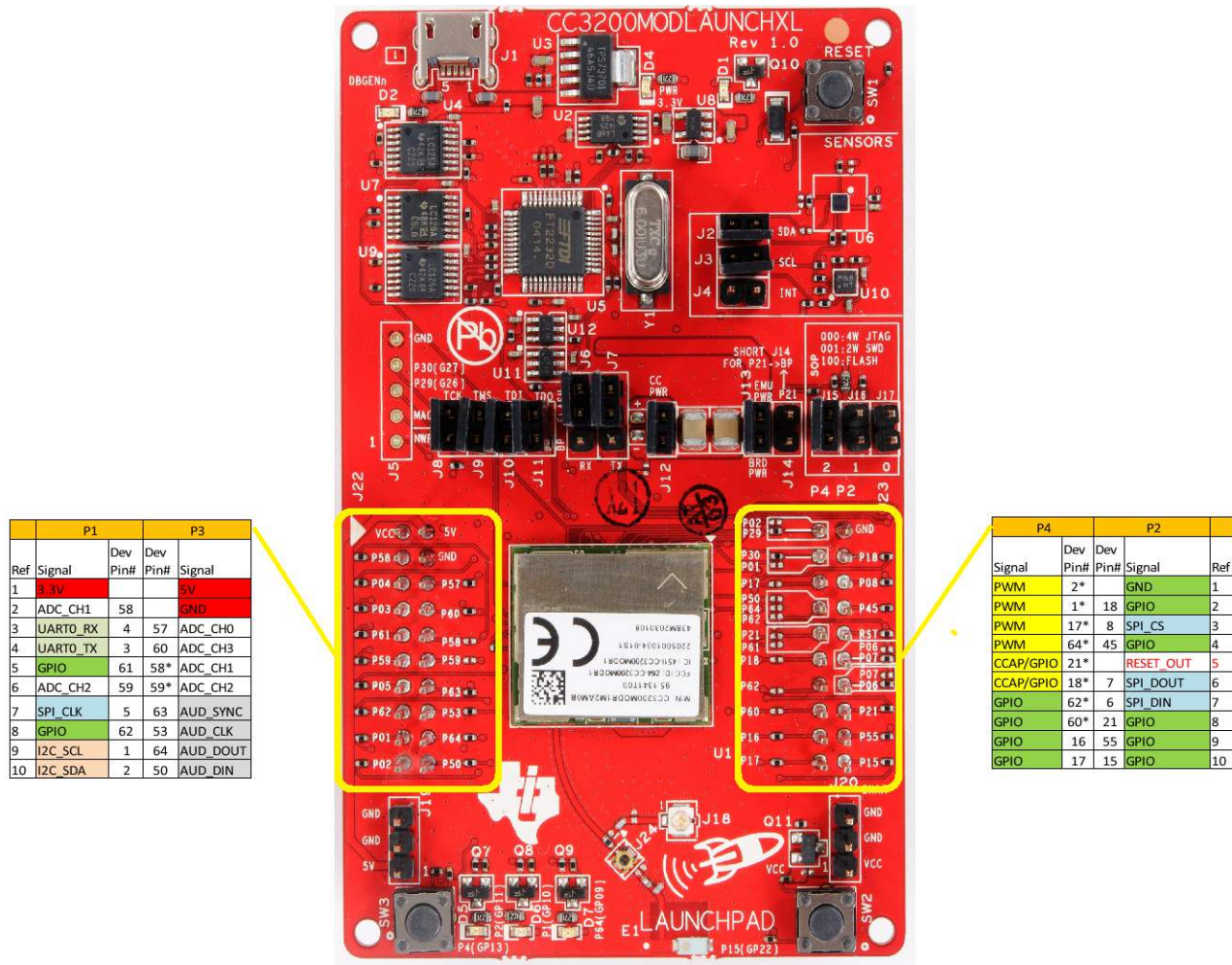

Figure 8. 2x20 Pin Connector

The signal mappings are as indicated in the table shown in Figure 8. All the signals are referred to by the pin number in the SDK, and Figure 8 shows the default mappings. Note that some of the pins are repeated across the connector. For instance, pin 62 is available on P1 and P4, but only P1 is connected by default. The signal on P4 is marked with a \*(star) to signify that it is not connected by default and can be routed to the pin by using a 0 Ω resistor in the path. For the exact resistor placement, see the [schematics and placement diagram](#).

## 2.5 Power

The LaunchPad can be powered by the USB connection or by external 2xAA/2xAAA batteries.

### 2.5.1 USB Power

The LaunchPad is designed to work from the USB provided power supply. The LaunchPad enumerates as a bus-powered device on the computer. When the board is powered from the USB connector, place the jumpers on the following headers, as shown in Figure 9.

J12 (shorted)

J13 (shorted)

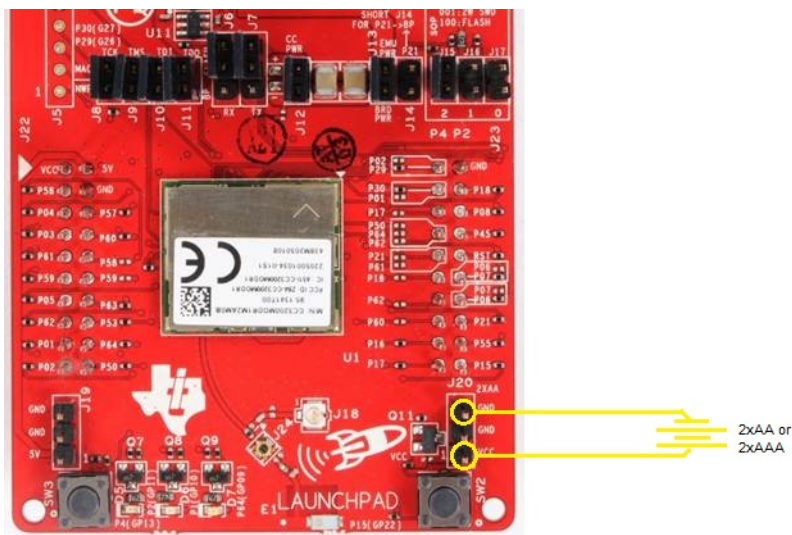

**Figure 9. Powering From USB**

### 2.5.2 Battery Power (2 x 1.5 V)

The LaunchPad can also be powered from an external battery pack by feeding the voltage on the J20 header. This input features reverse voltage protection to ensure that the board is not damaged due to an accidental reverse voltage. The following care should be taken while using the board with a battery:

1. Remove the USB cable.
2. Plug-in the battery pack on J20 with correct polarity (see [Figure 10](#)).



**Figure 10. Battery Power**

### 2.5.3 BoosterPack Power Supply

The CC3200MOD LaunchPad can be powered by a stacked booster-pack which can provide a 3.3 V power on P1.1. During this mode, remove the J13 so that the on-board LDO is not overloaded.

## 2.6 Measure CC3200MOD Current Drawn

To measure the current drawn of the CC3200MOD, use the 3V3 jumper on the jumper isolation block (J12). The current measured in this mode includes only the CC3200MOD current, and no external blocks. However, if a GPIO of the CC3200MOD is driving a high current load like LED, then that is also included in this measurement.

### 2.6.1 Measuring Low Power (< 1mA)

Follow these steps to measure ultra-low power:

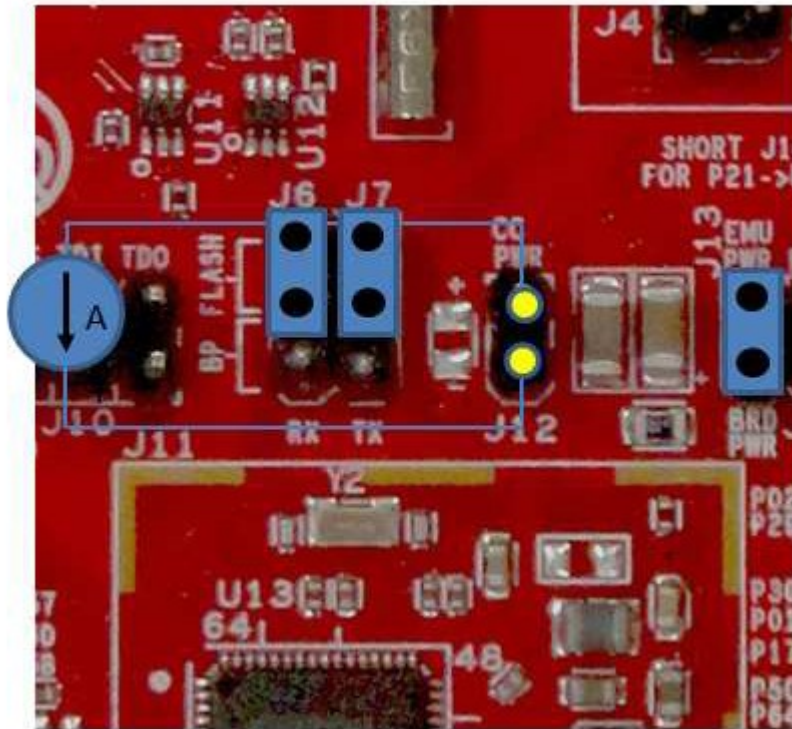
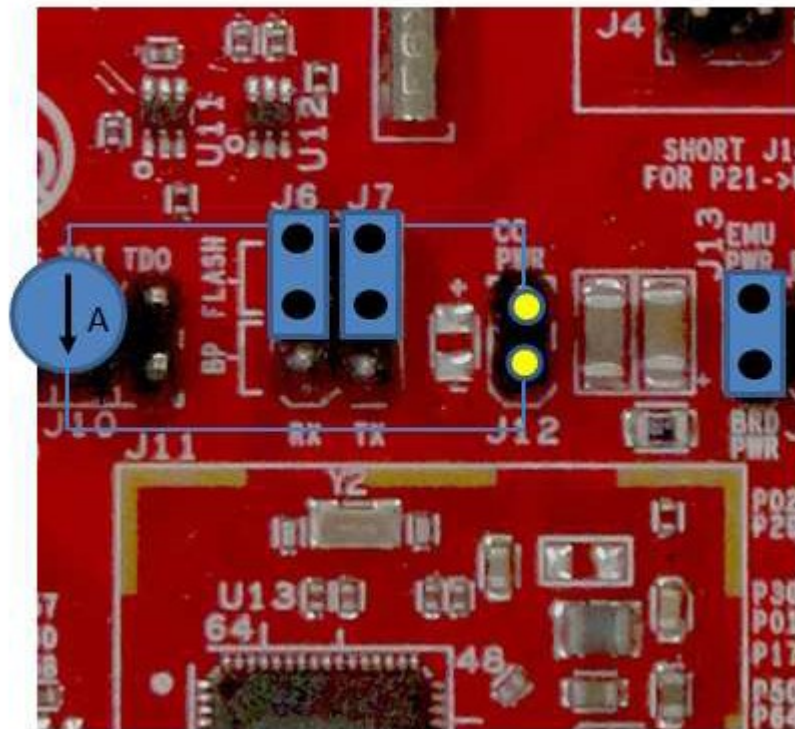

**Figure 11. Measuring Low Power**

1. Remove the 3V3 jumper (J12); attach an ammeter across this jumper.
2. Check that the CC3200MOD is not driving any high current loads directly, such as an LED, as this can cause large current drawn.
3. Begin target execution and set the device to low-power modes (LPDS or Hibernate).
4. Measure the current. Note that if the current levels are fluctuating, it may be difficult to get a stable measurement. It is easier to measure quiescent states.



## 2.6.2 Measuring Active Power



**Figure 12. Measuring Active Power**

1. Remove the 3V3 jumper (J12).
2. Solder a  $0.1 \Omega$  resistor on the board at R62. Or attach a jumper wire between J12, so that it can be used with a current probe.
3. Measure the voltage across the R62 using an oscilloscope with a differential probe. For the current probe, coil the wire around the sensor multiple times for good sensitivity.
4. An ammeter can also be used for this measurement, but the results may be erroneous due to the switching nature of the current.

## 2.7 RF Connections

### 2.7.1 Radiated Testing (AP connection)

By default, the board ships with the RF signals routed to the on-board chip antenna. An on-board u.fl (Murata) connector provides a means to perform the testing in the lab using a compatible cable.

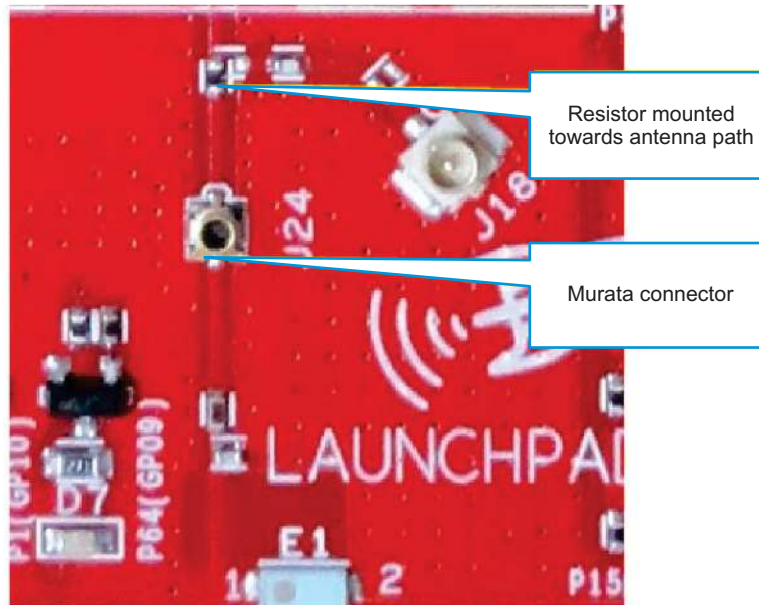

Figure 13. Radiated Testing Using Chip Antenna

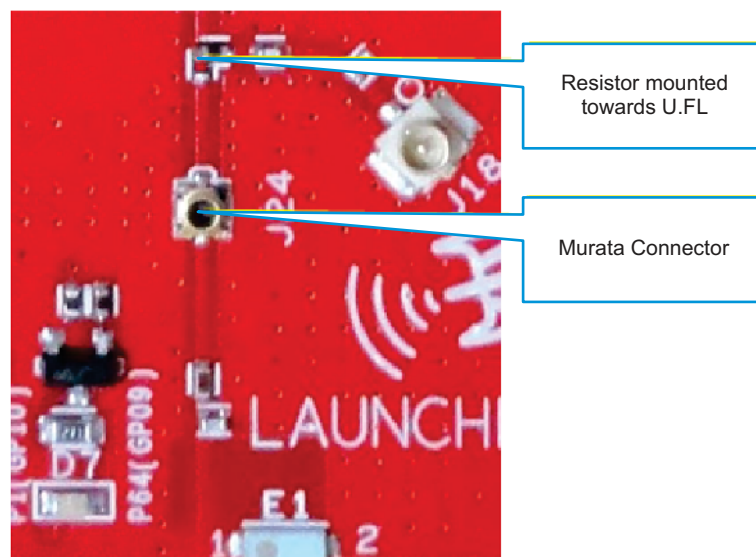

Figure 14. Board Set for Conducted Testing

## 2.8 Design Files

### 2.8.1 Hardware

All design files include schematics, layout, Bill of Materials (BOM), Gerber files, and documentation, which are available for download from <http://www.ti.com/tool/TIDC-CC3200MODLAUNCHXL>.

### 2.8.2 Revision History

**Table 10. Change Log**

PCB Revision	Description
Rev 1.0	Initial release

### 2.8.3 Software

All design files including firmware patches, software example projects, and documentation are made available from the [SimpleLink Wi-Fi Platform page](#).

The Software Development Kit (SDK) for use with the CC3200 LaunchPad can be obtained from <http://www.ti.com/tool/cc3200sdk>.

## 3 Software Examples

### 3.1 Development Environment Requirements

Using any of the following software examples with the LaunchPad requires an integrated development environment (IDE) that supports the CC3200 device.

For more details on where to download the latest IDE, see [Section 4.3](#).

The CC3200 Programmer's guide ([SWRU369](#)) has detailed information on software environment setup, with examples. Refer to this document for further details on the software sample examples.

#### 3.1.1 CCS

CCS 6.0 or higher is required. When CCS has been launched and a workspace directory chosen, use *Project* → *Import Existing CCS Eclipse Project*. Direct it to the desired demo's project directory containing `main.c`.

#### 3.1.2 IAR

IAR 6.70 or higher is required. To open the demo in IAR, choose *File* → *Open* → *Workspace...*, and direct it to the `*.eww` workspace file inside the IAR subdirectory of the desired demo. All workspace information is contained within this file. Additional Resources [www.ti.com](#)

The subdirectory also has an `*.ewp` project file. This file can be opened into an existing workspace using *Project* → *Add-Existing-Project...*

## 4 Additional Resources

### 4.1 *LaunchPad Wiki*

Updated information is available on the [CC3200 Wiki page](#).

### 4.2 *Information on the CC3200MOD*

For more information on the CC3200MOD, visit the product page at <http://www.ti.com/product/cc3200mod> for datasheet and key documents such as the technical reference manual (TRM), and the Wiki at <http://www.ti.com/simplelinkwifi-wiki> for information for Getting started, Hardware details, Software details including porting information, Test/Certification, and Support and Community.

### 4.3 *Download CCS, IAR*

Although the files can be viewed with any text editor, more can be done with the projects using a [development environment](#) like [Code Composer Studio \(CCS\)](#), [IAR](#), or [Energia](#).

CCS and IAR are each available in a full version, or a free, code-size-limited version. The full out-of-box demo cannot be built with the free version of CCS or IAR (IAR Kickstart) due to the code size limit. To bypass this limitation, a code-size-limited CCS version is provided that has most functionality integrated into a library. The code built into the library can be viewed by the user, but it cannot be edited. For full functionality, download the full version of either CCS or IAR.

### 4.4 *CC3200 Code Examples*

The user's guide for each example can be found within the [Software Development Kit \(SDK\)](#), or on the [Simplelink Wiki](#).

### 4.5 *CC3200 Application Notes*

Many application notes with practical design examples and topics are located at the [SimpleLink\(TM\) Wi-Fi\(R\) main wiki page](#), and the [main landing page](#).

### 4.6 *The TI E2E Community*

Search the forums at [e2e.ti.com](http://e2e.ti.com). To find your answer, post your question to the community.



## Revision History

NOTE: Page numbers for previous revisions may differ from page numbers in the current version.

Changes from Original (December 2014) to A Revision	Page
• Updated Hardware design Files link.....	19

### STANDARD TERMS FOR EVALUATION MODULES

1. *Delivery:* TI delivers TI evaluation boards, kits, or modules, including any accompanying demonstration software, components, and/or documentation which may be provided together or separately (collectively, an “EVM” or “EVMs”) to the User (“User”) in accordance with the terms set forth herein. User’s acceptance of the EVM is expressly subject to the following terms.
  - 1.1 EVMs are intended solely for product or software developers for use in a research and development setting to facilitate feasibility evaluation, experimentation, or scientific analysis of TI semiconductors products. EVMs have no direct function and are not finished products. EVMs shall not be directly or indirectly assembled as a part or subassembly in any finished product. For clarification, any software or software tools provided with the EVM (“Software”) shall not be subject to the terms and conditions set forth herein but rather shall be subject to the applicable terms that accompany such Software
  - 1.2 EVMs are not intended for consumer or household use. EVMs may not be sold, sublicensed, leased, rented, loaned, assigned, or otherwise distributed for commercial purposes by Users, in whole or in part, or used in any finished product or production system.
  
2. *Limited Warranty and Related Remedies/Disclaimers:*
  - 2.1 These terms do not apply to Software. The warranty, if any, for Software is covered in the applicable Software License Agreement.
  - 2.2 TI warrants that the TI EVM will conform to TI’s published specifications for ninety (90) days after the date TI delivers such EVM to User. Notwithstanding the foregoing, TI shall not be liable for a nonconforming EVM if (a) the nonconformity was caused by neglect, misuse or mistreatment by an entity other than TI, including improper installation or testing, or for any EVMs that have been altered or modified in any way by an entity other than TI, (b) the nonconformity resulted from User’s design, specifications or instructions for such EVMs or improper system design, or (c) User has not paid on time. Testing and other quality control techniques are used to the extent TI deems necessary. TI does not test all parameters of each EVM. User’s claims against TI under this Section 2 are void if User fails to notify TI of any apparent defects in the EVMs within ten (10) business days after delivery, or of any hidden defects with ten (10) business days after the defect has been detected.
  - 2.3 TI’s sole liability shall be at its option to repair or replace EVMs that fail to conform to the warranty set forth above, or credit User’s account for such EVM. TI’s liability under this warranty shall be limited to EVMs that are returned during the warranty period to the address designated by TI and that are determined by TI not to conform to such warranty. If TI elects to repair or replace such EVM, TI shall have a reasonable time to repair such EVM or provide replacements. Repaired EVMs shall be warranted for the remainder of the original warranty period. Replaced EVMs shall be warranted for a new full ninety (90) day warranty period.
  
3. *Regulatory Notices:*
  - 3.1 *United States*
    - 3.1.1 *Notice applicable to EVMs not FCC-Approved:*  
**FCC NOTICE:** This kit is designed to allow product developers to evaluate electronic components, circuitry, or software associated with the kit to determine whether to incorporate such items in a finished product and software developers to write software applications for use with the end product. This kit is not a finished product and when assembled may not be resold or otherwise marketed unless all required FCC equipment authorizations are first obtained. Operation is subject to the condition that this product not cause harmful interference to licensed radio stations and that this product accept harmful interference. Unless the assembled kit is designed to operate under part 15, part 18 or part 95 of this chapter, the operator of the kit must operate under the authority of an FCC license holder or must secure an experimental authorization under part 5 of this chapter.
    - 3.1.2 *For EVMs annotated as FCC – FEDERAL COMMUNICATIONS COMMISSION Part 15 Compliant:*

**CAUTION**

This device complies with part 15 of the FCC Rules. Operation is subject to the following two conditions: (1) This device may not cause harmful interference, and (2) this device must accept any interference received, including interference that may cause undesired operation.

Changes or modifications not expressly approved by the party responsible for compliance could void the user’s authority to operate the equipment.

**FCC Interference Statement for Class A EVM devices**

## STANDARD TERMS FOR EVALUATION MODULES (continued)

*NOTE: This equipment has been tested and found to comply with the limits for a Class A digital device, pursuant to part 15 of the FCC Rules. These limits are designed to provide reasonable protection against harmful interference when the equipment is operated in a commercial environment. This equipment generates, uses, and can radiate radio frequency energy and, if not installed and used in accordance with the instruction manual, may cause harmful interference to radio communications. Operation of this equipment in a residential area is likely to cause harmful interference in which case the user will be required to correct the interference at his own expense.*

### FCC Interference Statement for Class B EVM devices

*NOTE: This equipment has been tested and found to comply with the limits for a Class B digital device, pursuant to part 15 of the FCC Rules. These limits are designed to provide reasonable protection against harmful interference in a residential installation. This equipment generates, uses and can radiate radio frequency energy and, if not installed and used in accordance with the instructions, may cause harmful interference to radio communications. However, there is no guarantee that interference will not occur in a particular installation. If this equipment does cause harmful interference to radio or television reception, which can be determined by turning the equipment off and on, the user is encouraged to try to correct the interference by one or more of the following measures:*

- Reorient or relocate the receiving antenna.
- Increase the separation between the equipment and receiver.
- Connect the equipment into an outlet on a circuit different from that to which the receiver is connected.
- Consult the dealer or an experienced radio/TV technician for help.

### 3.2 Canada

#### 3.2.1 For EVMs issued with an Industry Canada Certificate of Conformance to RSS-210 or RSS-247

##### Concerning EVMs Including Radio Transmitters:

This device complies with Industry Canada license-exempt RSSs. Operation is subject to the following two conditions:

(1) this device may not cause interference, and (2) this device must accept any interference, including interference that may cause undesired operation of the device.

##### Concernant les EVMs avec appareils radio:

Le présent appareil est conforme aux CNR d'Industrie Canada applicables aux appareils radio exempts de licence. L'exploitation est autorisée aux deux conditions suivantes: (1) l'appareil ne doit pas produire de brouillage, et (2) l'utilisateur de l'appareil doit accepter tout brouillage radioélectrique subi, même si le brouillage est susceptible d'en compromettre le fonctionnement.

##### Concerning EVMs Including Detachable Antennas:

Under Industry Canada regulations, this radio transmitter may only operate using an antenna of a type and maximum (or lesser) gain approved for the transmitter by Industry Canada. To reduce potential radio interference to other users, the antenna type and its gain should be so chosen that the equivalent isotropically radiated power (e.i.r.p.) is not more than that necessary for successful communication. This radio transmitter has been approved by Industry Canada to operate with the antenna types listed in the user guide with the maximum permissible gain and required antenna impedance for each antenna type indicated. Antenna types not included in this list, having a gain greater than the maximum gain indicated for that type, are strictly prohibited for use with this device.

##### Concernant les EVMs avec antennes détachables

Conformément à la réglementation d'Industrie Canada, le présent émetteur radio peut fonctionner avec une antenne d'un type et d'un gain maximal (ou inférieur) approuvé pour l'émetteur par Industrie Canada. Dans le but de réduire les risques de brouillage radioélectrique à l'intention des autres utilisateurs, il faut choisir le type d'antenne et son gain de sorte que la puissance isotrope rayonnée équivalente (p.i.r.e.) ne dépasse pas l'intensité nécessaire à l'établissement d'une communication satisfaisante. Le présent émetteur radio a été approuvé par Industrie Canada pour fonctionner avec les types d'antenne énumérés dans le manuel d'usage et ayant un gain admissible maximal et l'impédance requise pour chaque type d'antenne. Les types d'antenne non inclus dans cette liste, ou dont le gain est supérieur au gain maximal indiqué, sont strictement interdits pour l'exploitation de l'émetteur.

### 3.3 Japan

- 3.3.1 *Notice for EVMs delivered in Japan:* Please see [http://www.tij.co.jp/lstds/ti\\_ja/general/eStore/notice\\_01.page](http://www.tij.co.jp/lstds/ti_ja/general/eStore/notice_01.page) 日本国内に輸入される評価用キット、ボードについては、次のところをご覧ください。  
[http://www.tij.co.jp/lstds/ti\\_ja/general/eStore/notice\\_01.page](http://www.tij.co.jp/lstds/ti_ja/general/eStore/notice_01.page)



## STANDARD TERMS FOR EVALUATION MODULES (continued)

3.3.2 *Notice for Users of EVMs Considered "Radio Frequency Products" in Japan:* EVMs entering Japan may not be certified by TI as conforming to Technical Regulations of Radio Law of Japan.

If User uses EVMs in Japan, not certified to Technical Regulations of Radio Law of Japan, User is required to follow the instructions set forth by Radio Law of Japan, which includes, but is not limited to, the instructions below with respect to EVMs (which for the avoidance of doubt are stated strictly for convenience and should be verified by User):

1. Use EVMs in a shielded room or any other test facility as defined in the notification #173 issued by Ministry of Internal Affairs and Communications on March 28, 2006, based on Sub-section 1.1 of Article 6 of the Ministry's Rule for Enforcement of Radio Law of Japan,
2. Use EVMs only after User obtains the license of Test Radio Station as provided in Radio Law of Japan with respect to EVMs, or
3. Use of EVMs only after User obtains the Technical Regulations Conformity Certification as provided in Radio Law of Japan with respect to EVMs. Also, do not transfer EVMs, unless User gives the same notice above to the transferee. Please note that if User does not follow the instructions above, User will be subject to penalties of Radio Law of Japan.

【無線電波を送信する製品の開発キットをお使いになる際の注意事項】 開発キットの中には技術基準適合証明を受けていないものがあります。技術適合証明を受けていないものご使用に際しては、電波法遵守のため、以下のいずれかの措置を取っていただく必要がありますのでご注意ください。

1. 電波法施行規則第6条第1項第1号に基づく平成18年3月28日総務省告示第173号で定められた電波暗室等の試験設備でご使用いただく。
2. 実験局の免許を取得後ご使用いただく。
3. 技術基準適合証明を取得後ご使用いただく。

なお、本製品は、上記の「ご使用にあたっての注意」を譲渡先、移転先に通知しない限り、譲渡、移転できないものとします。

上記を遵守頂けない場合は、電波法の罰則が適用される可能性があることをご留意ください。 日本テキサス・

インスツルメンツ株式会社  
東京都新宿区西新宿6丁目24番1号  
西新宿三井ビル

3.3.3 *Notice for EVMs for Power Line Communication:* Please see [http://www.tij.co.jp/lsds/ti\\_ja/general/eStore/notice\\_02.page](http://www.tij.co.jp/lsds/ti_ja/general/eStore/notice_02.page)

電力線搬送波通信についての開発キットをお使いになる際の注意事項については、次のところをご覧ください。  
[http://www.tij.co.jp/lsds/ti\\_ja/general/eStore/notice\\_02.page](http://www.tij.co.jp/lsds/ti_ja/general/eStore/notice_02.page)

### 3.4 European Union

3.4.1 *For EVMs subject to EU Directive 2014/30/EU (Electromagnetic Compatibility Directive):*

This is a class A product intended for use in environments other than domestic environments that are connected to a low-voltage power-supply network that supplies buildings used for domestic purposes. In a domestic environment this product may cause radio interference in which case the user may be required to take adequate measures.

### 4 EVM Use Restrictions and Warnings:

- 4.1 EVMs ARE NOT FOR USE IN FUNCTIONAL SAFETY AND/OR SAFETY CRITICAL EVALUATIONS, INCLUDING BUT NOT LIMITED TO EVALUATIONS OF LIFE SUPPORT APPLICATIONS.
- 4.2 User must read and apply the user guide and other available documentation provided by TI regarding the EVM prior to handling or using the EVM, including without limitation any warning or restriction notices. The notices contain important safety information related to, for example, temperatures and voltages.
- 4.3 *Safety-Related Warnings and Restrictions:*

**STANDARD TERMS FOR EVALUATION MODULES (continued)**

- 4.3.1 User shall operate the EVM within TI's recommended specifications and environmental considerations stated in the user guide, other available documentation provided by TI, and any other applicable requirements and employ reasonable and customary safeguards. Exceeding the specified performance ratings and specifications (including but not limited to input and output voltage, current, power, and environmental ranges) for the EVM may cause personal injury or death, or property damage. If there are questions concerning performance ratings and specifications, User should contact a TI field representative prior to connecting interface electronics including input power and intended loads. Any loads applied outside of the specified output range may also result in unintended and/or inaccurate operation and/or possible permanent damage to the EVM and/or interface electronics. Please consult the EVM user guide prior to connecting any load to the EVM output. If there is uncertainty as to the load specification, please contact a TI field representative. During normal operation, even with the inputs and outputs kept within the specified allowable ranges, some circuit components may have elevated case temperatures. These components include but are not limited to linear regulators, switching transistors, pass transistors, current sense resistors, and heat sinks, which can be identified using the information in the associated documentation. When working with the EVM, please be aware that the EVM may become very warm.
- 4.3.2 EVMs are intended solely for use by technically qualified, professional electronics experts who are familiar with the dangers and application risks associated with handling electrical mechanical components, systems, and subsystems. User assumes all responsibility and liability for proper and safe handling and use of the EVM by User or its employees, affiliates, contractors or designees. User assumes all responsibility and liability to ensure that any interfaces (electronic and/or mechanical) between the EVM and any human body are designed with suitable isolation and means to safely limit accessible leakage currents to minimize the risk of electrical shock hazard. User assumes all responsibility and liability for any improper or unsafe handling or use of the EVM by User or its employees, affiliates, contractors or designees.
- 4.4 User assumes all responsibility and liability to determine whether the EVM is subject to any applicable international, federal, state, or local laws and regulations related to User's handling and use of the EVM and, if applicable, User assumes all responsibility and liability for compliance in all respects with such laws and regulations. User assumes all responsibility and liability for proper disposal and recycling of the EVM consistent with all applicable international, federal, state, and local requirements.
5. *Accuracy of Information:* To the extent TI provides information on the availability and function of EVMs, TI attempts to be as accurate as possible. However, TI does not warrant the accuracy of EVM descriptions, EVM availability or other information on its websites as accurate, complete, reliable, current, or error-free.
6. *Disclaimers:*
- 6.1 EXCEPT AS SET FORTH ABOVE, EVMS AND ANY MATERIALS PROVIDED WITH THE EVM (INCLUDING, BUT NOT LIMITED TO, REFERENCE DESIGNS AND THE DESIGN OF THE EVM ITSELF) ARE PROVIDED "AS IS" AND "WITH ALL FAULTS." TI DISCLAIMS ALL OTHER WARRANTIES, EXPRESS OR IMPLIED, REGARDING SUCH ITEMS, INCLUDING BUT NOT LIMITED TO ANY EPIDEMIC FAILURE WARRANTY OR IMPLIED WARRANTIES OF MERCHANTABILITY OR FITNESS FOR A PARTICULAR PURPOSE OR NON-INFRINGEMENT OF ANY THIRD PARTY PATENTS, COPYRIGHTS, TRADE SECRETS OR OTHER INTELLECTUAL PROPERTY RIGHTS.
- 6.2 EXCEPT FOR THE LIMITED RIGHT TO USE THE EVM SET FORTH HEREIN, NOTHING IN THESE TERMS SHALL BE CONSTRUED AS GRANTING OR CONFERRING ANY RIGHTS BY LICENSE, PATENT, OR ANY OTHER INDUSTRIAL OR INTELLECTUAL PROPERTY RIGHT OF TI, ITS SUPPLIERS/LICENSORS OR ANY OTHER THIRD PARTY, TO USE THE EVM IN ANY FINISHED END-USER OR READY-TO-USE FINAL PRODUCT, OR FOR ANY INVENTION, DISCOVERY OR IMPROVEMENT, REGARDLESS OF WHEN MADE, CONCEIVED OR ACQUIRED.
7. *USER'S INDEMNITY OBLIGATIONS AND REPRESENTATIONS.* USER WILL DEFEND, INDEMNIFY AND HOLD TI, ITS LICENSORS AND THEIR REPRESENTATIVES HARMLESS FROM AND AGAINST ANY AND ALL CLAIMS, DAMAGES, LOSSES, EXPENSES, COSTS AND LIABILITIES (COLLECTIVELY, "CLAIMS") ARISING OUT OF OR IN CONNECTION WITH ANY HANDLING OR USE OF THE EVM THAT IS NOT IN ACCORDANCE WITH THESE TERMS. THIS OBLIGATION SHALL APPLY WHETHER CLAIMS ARISE UNDER STATUTE, REGULATION, OR THE LAW OF TORT, CONTRACT OR ANY OTHER LEGAL THEORY, AND EVEN IF THE EVM FAILS TO PERFORM AS DESCRIBED OR EXPECTED.
8. *Limitations on Damages and Liability:*

**STANDARD TERMS FOR EVALUATION MODULES (continued)**

- 8.1 *General Limitations.* IN NO EVENT SHALL TI BE LIABLE FOR ANY SPECIAL, COLLATERAL, INDIRECT, PUNITIVE, INCIDENTAL, CONSEQUENTIAL, OR EXEMPLARY DAMAGES IN CONNECTION WITH OR ARISING OUT OF THESE TERMS OR THE USE OF THE EVMS, REGARDLESS OF WHETHER TI HAS BEEN ADVISED OF THE POSSIBILITY OF SUCH DAMAGES. EXCLUDED DAMAGES INCLUDE, BUT ARE NOT LIMITED TO, COST OF REMOVAL OR REINSTALLATION, ANCILLARY COSTS TO THE PROCUREMENT OF SUBSTITUTE GOODS OR SERVICES, RETESTING, OUTSIDE COMPUTER TIME, LABOR COSTS, LOSS OF GOODWILL, LOSS OF PROFITS, LOSS OF SAVINGS, LOSS OF USE, LOSS OF DATA, OR BUSINESS INTERRUPTION. NO CLAIM, SUIT OR ACTION SHALL BE BROUGHT AGAINST TI MORE THAN TWELVE (12) MONTHS AFTER THE EVENT THAT GAVE RISE TO THE CAUSE OF ACTION HAS OCCURRED.
- 8.2 *Specific Limitations.* IN NO EVENT SHALL TI'S AGGREGATE LIABILITY FROM ANY USE OF AN EVM PROVIDED HEREUNDER, INCLUDING FROM ANY WARRANTY, INDEMNITY OR OTHER OBLIGATION ARISING OUT OF OR IN CONNECTION WITH THESE TERMS, EXCEED THE TOTAL AMOUNT PAID TO TI BY USER FOR THE PARTICULAR EVM(S) AT ISSUE DURING THE PRIOR TWELVE (12) MONTHS WITH RESPECT TO WHICH LOSSES OR DAMAGES ARE CLAIMED. THE EXISTENCE OF MORE THAN ONE CLAIM SHALL NOT ENLARGE OR EXTEND THIS LIMIT.
9. *Return Policy.* Except as otherwise provided, TI does not offer any refunds, returns, or exchanges. Furthermore, no return of EVM(s) will be accepted if the package has been opened and no return of the EVM(s) will be accepted if they are damaged or otherwise not in a resalable condition. If User feels it has been incorrectly charged for the EVM(s) it ordered or that delivery violates the applicable order, User should contact TI. All refunds will be made in full within thirty (30) working days from the return of the components(s), excluding any postage or packaging costs.
10. *Governing Law:* These terms and conditions shall be governed by and interpreted in accordance with the laws of the State of Texas, without reference to conflict-of-laws principles. User agrees that non-exclusive jurisdiction for any dispute arising out of or relating to these terms and conditions lies within courts located in the State of Texas and consents to venue in Dallas County, Texas. Notwithstanding the foregoing, any judgment may be enforced in any United States or foreign court, and TI may seek injunctive relief in any United States or foreign court.

## IMPORTANT NOTICE FOR TI DESIGN INFORMATION AND RESOURCES

Texas Instruments Incorporated ("TI") technical, application or other design advice, services or information, including, but not limited to, reference designs and materials relating to evaluation modules, (collectively, "TI Resources") are intended to assist designers who are developing applications that incorporate TI products; by downloading, accessing or using any particular TI Resource in any way, you (individually or, if you are acting on behalf of a company, your company) agree to use it solely for this purpose and subject to the terms of this Notice.

TI's provision of TI Resources does not expand or otherwise alter TI's applicable published warranties or warranty disclaimers for TI products, and no additional obligations or liabilities arise from TI providing such TI Resources. TI reserves the right to make corrections, enhancements, improvements and other changes to its TI Resources.

You understand and agree that you remain responsible for using your independent analysis, evaluation and judgment in designing your applications and that you have full and exclusive responsibility to assure the safety of your applications and compliance of your applications (and of all TI products used in or for your applications) with all applicable regulations, laws and other applicable requirements. You represent that, with respect to your applications, you have all the necessary expertise to create and implement safeguards that (1) anticipate dangerous consequences of failures, (2) monitor failures and their consequences, and (3) lessen the likelihood of failures that might cause harm and take appropriate actions. You agree that prior to using or distributing any applications that include TI products, you will thoroughly test such applications and the functionality of such TI products as used in such applications. TI has not conducted any testing other than that specifically described in the published documentation for a particular TI Resource.

You are authorized to use, copy and modify any individual TI Resource only in connection with the development of applications that include the TI product(s) identified in such TI Resource. NO OTHER LICENSE, EXPRESS OR IMPLIED, BY ESTOPPEL OR OTHERWISE TO ANY OTHER TI INTELLECTUAL PROPERTY RIGHT, AND NO LICENSE TO ANY TECHNOLOGY OR INTELLECTUAL PROPERTY RIGHT OF TI OR ANY THIRD PARTY IS GRANTED HEREIN, including but not limited to any patent right, copyright, mask work right, or other intellectual property right relating to any combination, machine, or process in which TI products or services are used. Information regarding or referencing third-party products or services does not constitute a license to use such products or services, or a warranty or endorsement thereof. Use of TI Resources may require a license from a third party under the patents or other intellectual property of the third party, or a license from TI under the patents or other intellectual property of TI.

TI RESOURCES ARE PROVIDED "AS IS" AND WITH ALL FAULTS. TI DISCLAIMS ALL OTHER WARRANTIES OR REPRESENTATIONS, EXPRESS OR IMPLIED, REGARDING TI RESOURCES OR USE THEREOF, INCLUDING BUT NOT LIMITED TO ACCURACY OR COMPLETENESS, TITLE, ANY EPIDEMIC FAILURE WARRANTY AND ANY IMPLIED WARRANTIES OF MERCHANTABILITY, FITNESS FOR A PARTICULAR PURPOSE, AND NON-INFRINGEMENT OF ANY THIRD PARTY INTELLECTUAL PROPERTY RIGHTS.

TI SHALL NOT BE LIABLE FOR AND SHALL NOT DEFEND OR INDEMNIFY YOU AGAINST ANY CLAIM, INCLUDING BUT NOT LIMITED TO ANY INFRINGEMENT CLAIM THAT RELATES TO OR IS BASED ON ANY COMBINATION OF PRODUCTS EVEN IF DESCRIBED IN TI RESOURCES OR OTHERWISE. IN NO EVENT SHALL TI BE LIABLE FOR ANY ACTUAL, DIRECT, SPECIAL, COLLATERAL, INDIRECT, PUNITIVE, INCIDENTAL, CONSEQUENTIAL OR EXEMPLARY DAMAGES IN CONNECTION WITH OR ARISING OUT OF TI RESOURCES OR USE THEREOF, AND REGARDLESS OF WHETHER TI HAS BEEN ADVISED OF THE POSSIBILITY OF SUCH DAMAGES.

You agree to fully indemnify TI and its representatives against any damages, costs, losses, and/or liabilities arising out of your non-compliance with the terms and provisions of this Notice.

This Notice applies to TI Resources. Additional terms apply to the use and purchase of certain types of materials, TI products and services. These include; without limitation, TI's standard terms for semiconductor products (<http://www.ti.com/sc/docs/stdterms.htm>), [evaluation modules](#), and [samples](http://www.ti.com/sc/docs/sampterm.htm) (<http://www.ti.com/sc/docs/sampterm.htm>).

Mailing Address: Texas Instruments, Post Office Box 655303, Dallas, Texas 75265  
Copyright © 2018, Texas Instruments Incorporated