MS

CONNECTORS



MS Connectors

Contents

General Information	2
Contact Arrangements	5
Wall Mounting Receptacles	12
Cable Connecting Plugs	13
Box Mounting Receptacles	14
Straight Plug	14
90° Angle Plug	15
Straight Plugs, CA-F Types	16
Straight Plugs, CA-E Typ	17
Through-Bulkhead	17
Straight Plugs, CA-EA/EB Type	18
Accessories	19
Tools for Crimp Contacts	23
Product Safety Information	24

Introduction

This catalogue describes ITT Cannon connectors designed and manufactured to MIL-C-5015, the military specification covering MS electrical connectors. These connectors were originally designed for aircraft, but are now widely used in many other fields. They are particularly suitable for commercial applications requiring low cost and high reliability.

The design of connector classes MS-E, MS-F and MS-R conform to MIL-C-5015 D. The new class F connectors supersede the previous class E connectors. For new programs only class F should be ordered.

The coupling measurements as well as the dimensions of class MS-E, -F and -R are in accordance with the latest revision of VG 0095342. Wall mount receptacle, box receptacle, cable connector and straight plug have the same

coupling dimensions. This allows mating of the different classes of these connectors.

The connectors of class E, F and R are designed to operate in extreme environmental conditions. These connectors are completely sealed to withstand moisture, condensation, vibration and flash-over. MS-F and MS-R connectors have a resilient grommet around each wire. This allows the wires to slide through the grommet with a minimum of friction. Yet when the ferrule is sealed, and the endbells tightened, it provides perfect wire seal through a wide variety of wire diameters. This seal at the rear plus the interfacial seal at the front, effect a completely environmental resistant assembly when the plug is mated to an F or R receptacle.

Class Differences

Connector classes MS 3106F, MS 3106R and MS 3108R feature an O-ring under the coupling nut. It is missing on connectors class MS 3106E and MS 3108E.

To reduce size and weight, connector classes MS 3100R, MS 3101R and MS 3106R have no cable strain relief. The 90° angle plug MS 3106R has no cable clamp and is suitable for hose connection. Strain relief for this connector has to be ordered separately (see page 19). Moreover, construction and materials used are identical for all connector classes.

Different Designations

Connectors with MS designation conform to MIL-C-5015 in respect of dimensions and contact arrangements.

Deviations from this specification, e. g. crimp contacts, other shell or contact finishes, are designated CA.

Design Features

Straight Plug (E- and F-Type)							O Ring MS-F only	
Straight Plug (R-Type)								
Bushing	Endbell	Ferrule	Grommet	Pin contacts	Insulator	Coupling Nut	Barrel	O Ring

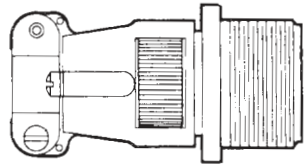
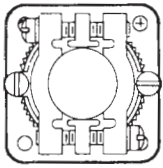

Wall mounting receptacles MS 3 100 and F/CA 3100F
Dimensions/sizes

Page 12

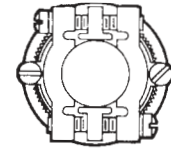
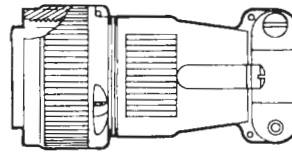

Straight plug MS 3106E and F/CA 3106E
Dimensions/sizes

Page 14

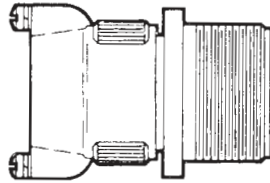
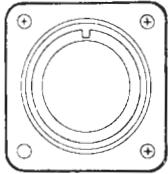

Wall mounting receptacle MS 3100R/CA 3100R
Dimensions/sizes

Page 12

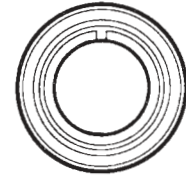
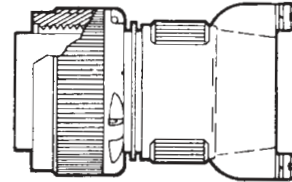

Straight plug MS 3106R/CA 3106R
Dimensions/sizes

Page 15

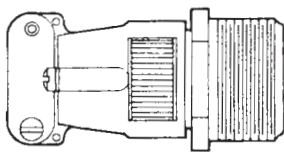
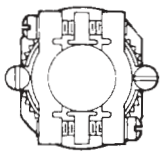

Cable connecting plug MS 3101E and F/CA 3101E
Dimensions/sizes

Page 13

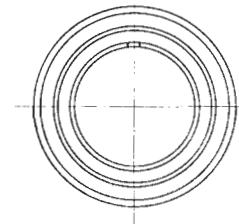
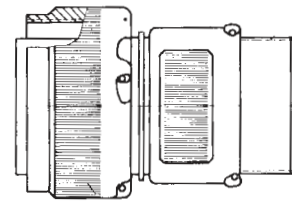

Straight plug CA 3106F
Dimensions/sizes

Page 16

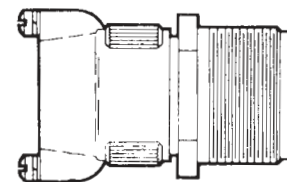
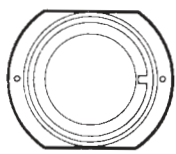

Cable connecting plug MS 3101R/CA 3101R
Dimensions/size

Page 13

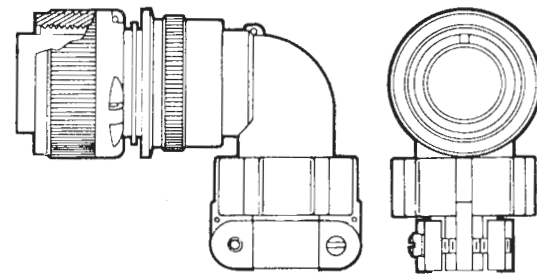

90° Angle plug MS 3108E and R/CA 3108E/F/R ¹⁾
1) MS 3108R, CA 3108F/R without cable clamp

Page 15

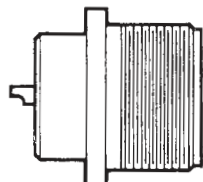
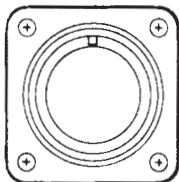

Box mounting receptacle MS 3102R/CA 3102E/R
Dimensions/sizes

Page 14

Accessories: Cable clamp, Telescoping bushing,
Sealing gaskets, Reduction sleeves,
Dust caps with and without chain, etc.

Pages 19 – 23

MS Connectors

Part Number Explanation

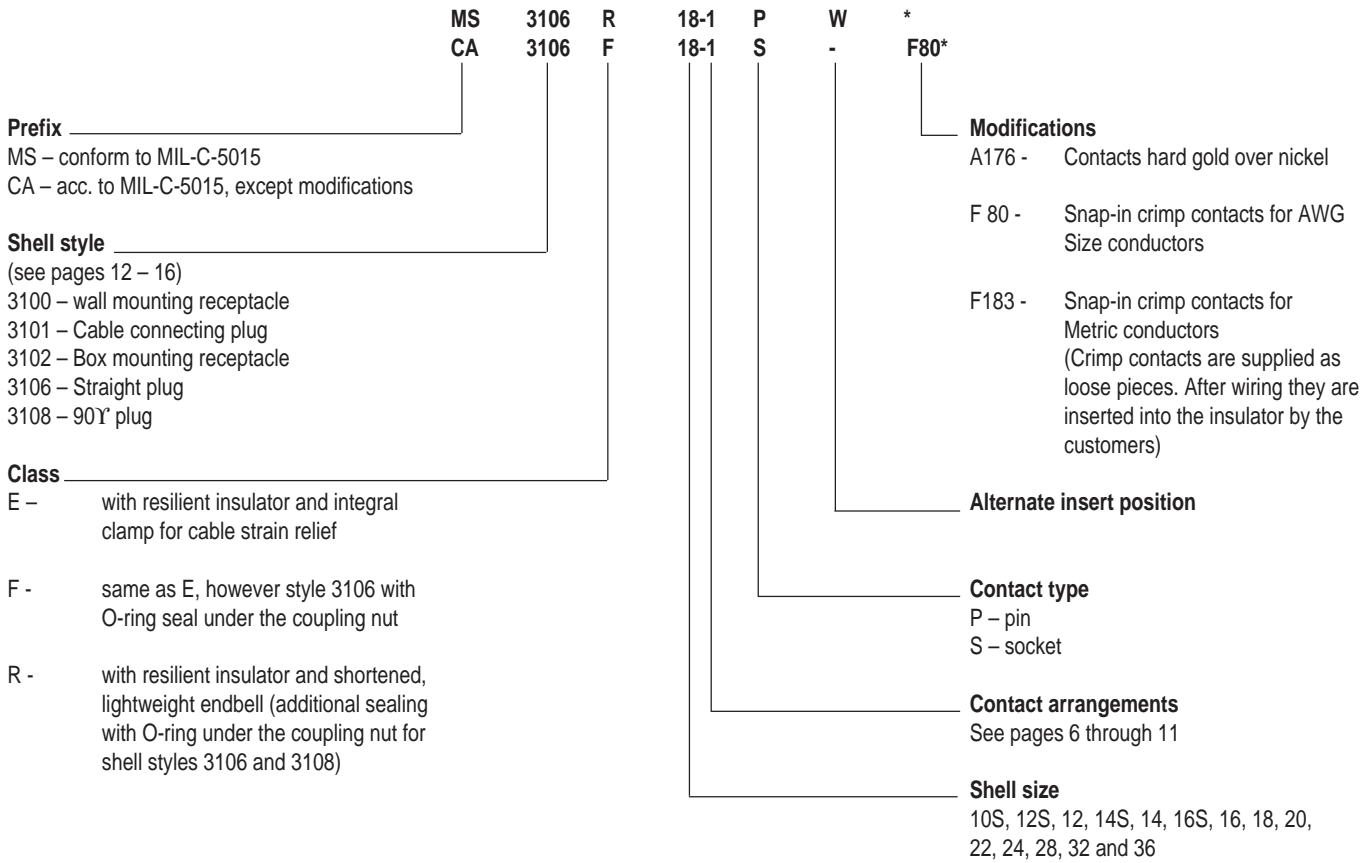

Standard Data

Shell	Material	Aluminum alloy
	Finish	Olive drab chromate coating over cadmium plating
Insulator	Material	Polychloroprene (resilient) acc. to MI-R-3065
Contacts	Material	Copper alloy or brass
	Finish	Silver plated, solder pots tinned
	Termination	Crimp or solder for AWG and metric contact size
Operating Temperature		-55/125°C

Separation Force (N)

Contact sizes	AWG	-	16S/16	12	8	4	0
	Metr.	10	15S/15	245	100	160	500
Min. separation force		0,3	1,0	1,5	3	4	8,5

Please note:

Connector classes 00E/F, 01E/F, 06E/F and 0/E are always delivered with cable bushing. Dimensions of cable bushing see page 19.

Electrical Data

Nominal current and potential drop

Maximum current ratings of contacts and maximum allowable voltage drop under test conditions when assembled as in service are shown below.

Contact size AWG	16S/16	12	8	4	0
Contact size metric	15S/15	2.5	100	160	500
Wire size (mm ²)	1.0/1.5	2.5	10	16	50
Current rating (A)*	22	41	73	135	245
Potential drop (mV)	6	3	1	0.3	0.2

*measured between the contacts at +25⁻³ °C

Service rating

MS connectors show no evidence of breakdown when the test voltage given below is applied between the two closest contacts and between the shell and the contacts closest to the shell for a period of one minute.

High potential test voltage is conducted in VG 95319 part 2 test no. 5.13 and VG 95210 part 31.

MS Service rating	Instruments	A	D	E
Test voltage Veff 50 Hz	1050	1600	2500	3000
Air spacing mm	0.7	1.1	2.8	4.8
Creeping distance mm	0.7	1.1	2.8	4.8

Wire Selection

The connectors are designed for individual wiring. Spray water and moisture resistance are only guaranteed if wires according to MIL-W-5086, LN 9251 (for AWG diameters), TL 6145-009 and TL 6145-011 (for metric diameters) are used. When using wires which do not correspond to these specifications the wire diameters and outer dimensions of the insulation indicated in above table have to be adhered to.

Contact size Size	Conductor size for solder contacts		for crimp contacts				Insulation sizes (in mm) for	
	AWG	mm ²	AWG	conductor Ø mm	metric mm ²	conductor Ø mm	AWG contacts	metric contacts
- / 10	-	-	-	-	0,75 1,0	1,0 - 1,4	-	2,0 - 2,5
16S/15S	16-22	1,2 - 0,4	16	1,25 - 1,7	1,0 - 1,7	1,25 - 1,7	1,63 - 3,3	2,2 - 2,8
16 / 15	16-22	1,2 - 0,4	16	1,25 - 1,7	1,0 - 1,5	1,25 - 1,7	1,63 - 3,3	2,2 - 2,8
12 / 15	12-14	3,5 - 2,0	12	1,95 - 2,2	2,5	1,95 - 2,2	2,9 - 4,3	3,1 - 3,5
8 / 100	8 - 10	8,5 - 4,5	8	4,0 - 4,5	10	4,3 - 4,8	2,9 - 6,4	5,9 - 6,5
4 / 160	4 - 6	21,5 - 13,5	4	6,0 - 6,9	16	5,2 - 6,0	7,0 - 9,4	7,1 - 7,7
0 / 500	0 - 2	53,0 - 33,5	0	10,6 - 11,5	50	9,6 - 10,7	10,6 - 14,0	12,1 - 12,8

Shell Sizes and Contact Arrangements

On pages 6 – 9 the contact arrangements are shown by number of contacts. The shell size and the contact arrangement number are given in a designation of bold figures below each contact arrangement: The digits preceding the dash refer to the shell size. The digits following the dash are the contact arrangement numbers.

Under the contact arrangement designation the number of contacts and the contact size are indicated. The recommended wire sizes and the electrical data can be seen on page 4. The capital letters on the bottom refer to the service rating group. Max. operating voltage is given in the table on page 4.

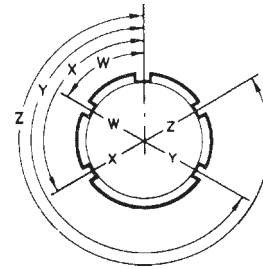

Pin front view

Alternated Insert Positions

Alternate insert positions are available to prevent cross-plugging of adjacent assemblies. The diagram with the degrees of rotation is shown on this page first. All MS qualified insert positions are listed on pages 6 – 9. Other positions than N (Normal) are not available from stock.

Contact arrangements

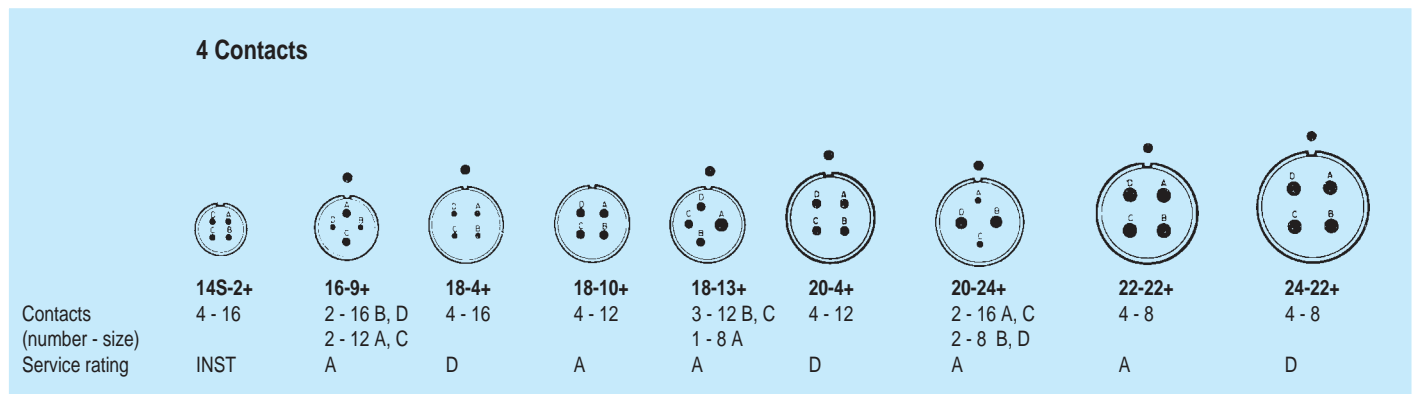
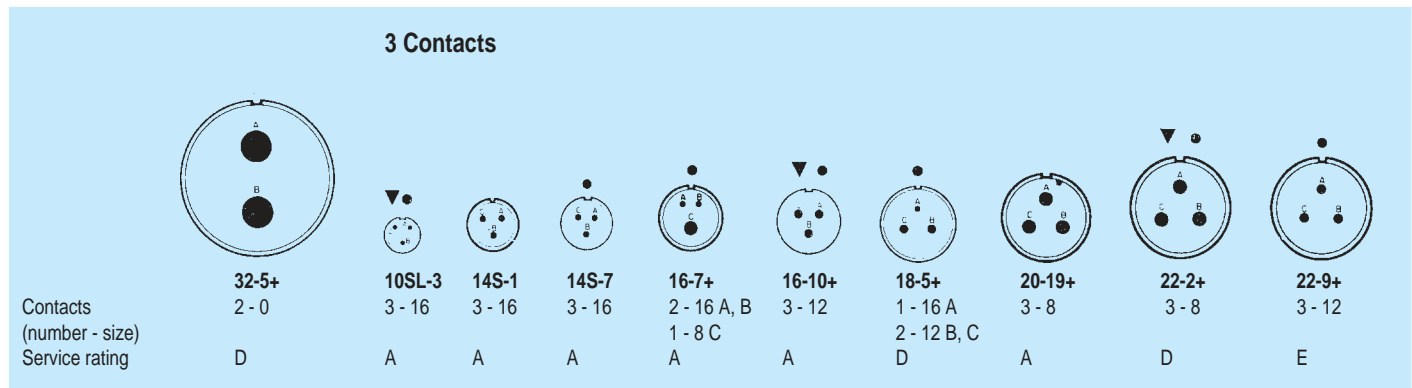
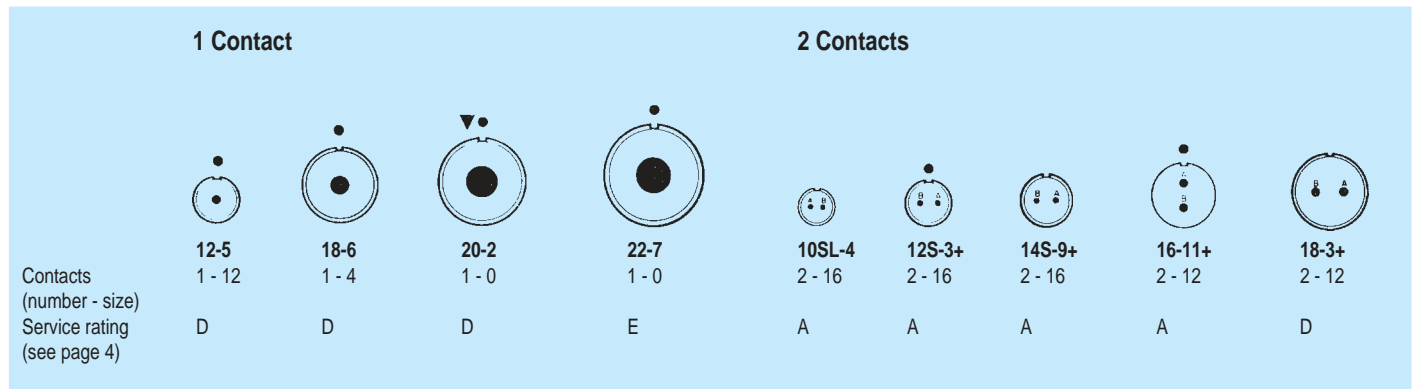

Shell Sizes and Contact Arrangements

No. of contacts	Contact arrangement	Degrees of rotation			
		W	X	Y	Z
2	12S-3*	70	145	215	290
	14S-9	70	145	215	290
	16-11	35	110	250	325
	32-5	35	110	250	325
3	14S-7*	90	180	270	-
	16-7	80	110	250	280
	16-10*	90	180	270	-
	18-5	80	110	250	280
	20-19	90	180	270	-
	22-2	70	145	215	290
4	14S-2	-	120	240	-
	16-9	35	110	250	325
	18-4	35	110	250	325

No. of contacts	Contact arrangement	Degrees of rotation			
		W	X	Y	Z
4	18-10	-	120	240	-
	18-13*	80	110	250	280
	20-4	45	110	250	-
	20-24	35	110	250	325
	22-22	-	110	250	-
	24-22	45	110	250	-
	32-17	45	110	250	-
	36-5	-	120	240	-

***Note:**

For alternate positions of these contact arrangements a tendency to overmate can be stated. It is within the customer's responsibility to use these insert positions.

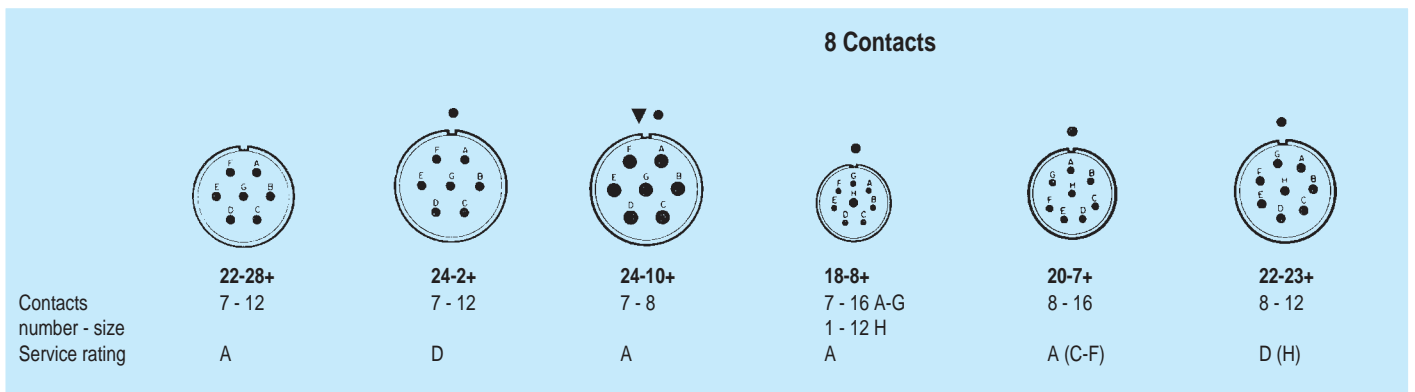
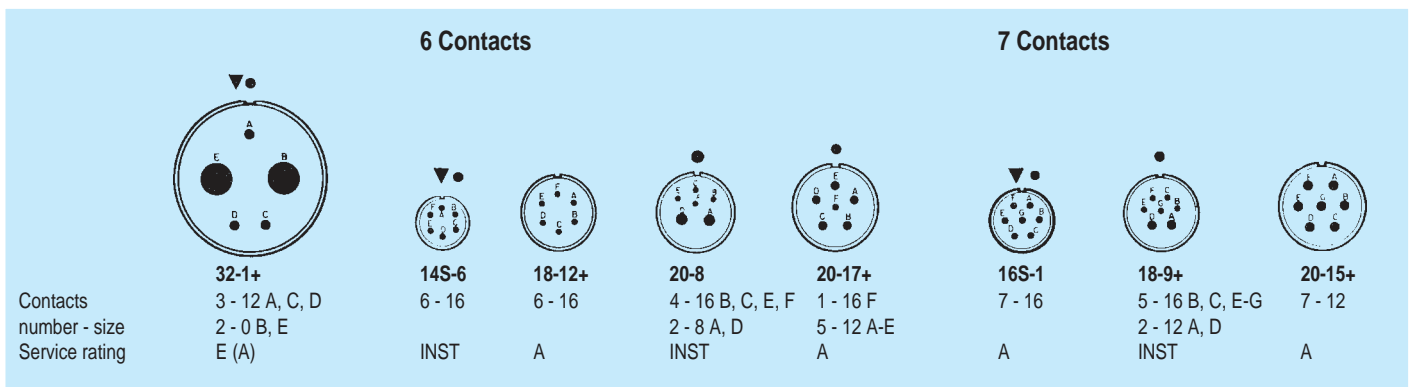
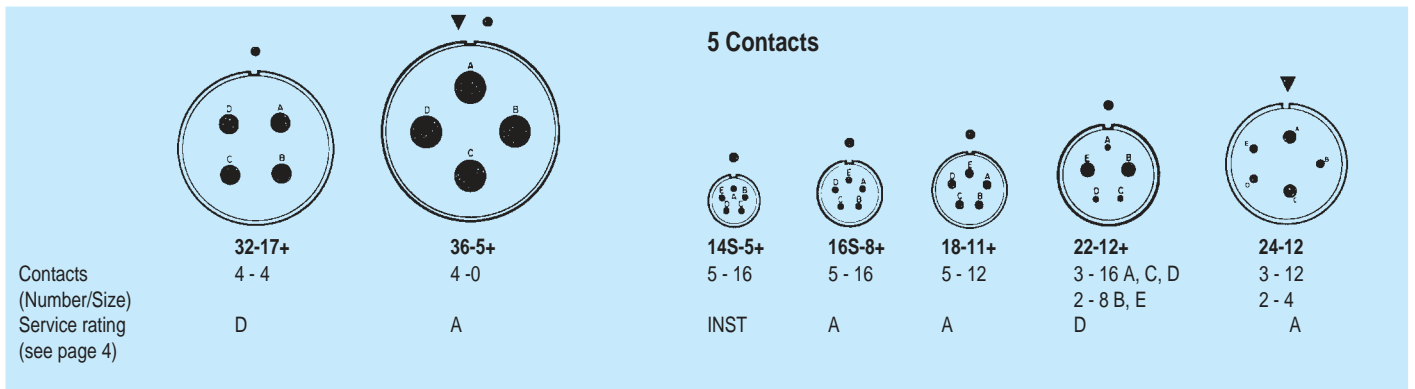

Shell Sizes and Contact Arrangements

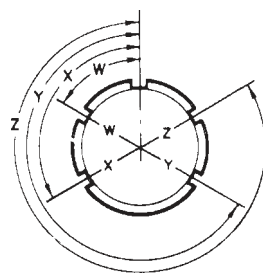

Pin front view; shell rotation

Legend

- Inserts to MIL-C-5015
- + MS Polarization
- ▼ VG Contact arrangements

No. of contacts	Contact arrangement	W	Degrees of rotation		
			X	Y	Z
5	14S-5	-	110	-	-
	16S-8	-	170	265	-
	18-11	-	170	265	-
	22-12	80	110	250	280
	32-1	80	110	250	280
6	18-12	80	-	-	280
	20-8	-	110	250	-
	20-17	90	180	270	-
7	16S-1*	80	-	-	280
	18-9	80	110	250	280
	20-15	80	-	-	280
	24-2	80	-	-	280
	24-10	80	-	-	280
8	18-8	70	-	-	290
	20-7	80	110	250	280
	22-23	35	-	250	-

Contact arrangements

9 Contacts

Contacts (number - size)	Service rating
20-16+ 7 - 16 A-G 2 - 12 H, I	A
20A9 9 - 12 D (J) A all others	D (J) A all others
22-20+ 9 - 16	A
22-27+ 8 - 16 A-H 1 - 8 J D (J)	D (J)
24-11+ 6 - 12 A-C, G-I 3 - 8 D-F	A
28-2009-16+ 5 - 16 A, D-F, J 4 - 4 B, C, G, H	A

10 Contacts

Contacts (number - size)	Service rating
18-1+ 10 - 16	A (B, C, F, G) INST all others

11 Contacts

Contacts (number - size)	Service rating
20-33 11 - 16	A
24-20+ 9 - 16 A-D, G-L 2 - 12 E, F	D

12 Contacts

Contacts (number - size)	Service rating
24-19 12 - 16	A

14 Contacts

Contacts (number - size)	Service rating
20-27+ 14 - 16	A
22-19+ 14 - 16	A
28-20+ 4 - 16 K-N 10 - 12 A-J, P	A

16 Contacts

Contacts (number - size)	Service rating
24-7+ 14 - 16 A-M, O 2 - 12	A

17 Contacts

Contacts (number - size)	Service rating
20-29+ 17 - 16	A

19 Contacts

Contacts (number - size)	Service rating
22-14+ 19 - 16	A

20A48

Contacts (number - size)	Service rating
20A48 19 - 15	INST

22 Contacts

Contacts (number - size)	Service rating
28-11+ 18 - 16 A-I, N-X 4 - 12 J-M	A

Shell Sizes and Contact Arrangements

No. of contacts	Contact arrangement	Degrees of rotation			
		W	X	Y	Z
9	20-16	80	110	250	280
	22-20	35	110	250	325
	22-27	80	-	250	280
	24-11	35	110	250	325
	28-2009-16	110	250	260	280
10	18-1*	70	145	215	290
11	20-33	110	130	260	-
	24-20	80	110	250	280
14	20-27	35	110	250	325
	22-19	80	110	250	280
	28-20	80	110	250	280
16	24-7	80	110	250	280
17	20-29*	80	-	-	280
19	22-14*	80	-	-	280
22	28-11	80	110	250	280

Pin front view; shell rotation

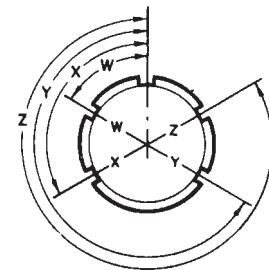

Legend

- Inserts to MIL-C-5015
- + MS Polarization
- ▼ VG Contact arrangements

	23 Contacts	24 Contacts	26 Contacts	28 Contacts
Contacts (number - size)	32-6+ 16 - 16 A - O, S 2 - 12 U, V 3 - 8 P, T, 2 - 4 W, X	24-28+ 24 - 16	28-12+ 26 - 16	28A63 19 - 15 9 - 25
Service rating	A	INST	A	A for e, INST all others

	30 Contacts	35 Contacts	37 Contacts	48 Contacts
Contacts (number - size)	32-8+ 24 - 16 A-L, T-Z, a-e 6 - 12 M-S	28-15+ 35 - 16	32-7+ 28 - 16 A-N, W-Z, a-k 7 - 12 O-V	36-10+ 48 - 16
Service rating	A	A	INST A, B, h, j - A all others A	A

	61 Contacts
Contacts (number - size)	32A69 41 - 10 20 - 15
Service rating	INST

Shell Sizes and Contact Arrangements

No. of contacts	Contact arrangement	Degrees of rotation			
		W	X	Y	Z
23	32-6	80	110	250	280
24	24-26	80	110	250	280
26	28-12	90	180	270	-
30	32-8	80	125	235	280
35	28-15	80	110	50	280
	32-7	80	125	235	280
32	28-21	80	110	250	280
48	36-10	80	125	235	280
61	32A69	-	110	250	-

Pin front view; shell rotation

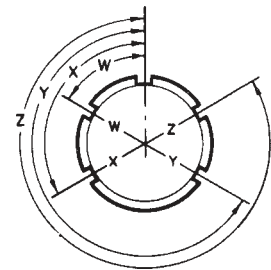

Legend

- Inserts to MIL-C-5015
- + MS Polarization
- ▼ VG Contact arrangements

Note:
For alternate positions of these contact arrangements a tendency to overmate can be stated. It is within the customer's responsibility to use these insert positions.

Contact arrangements

Contact arrangement	No. of contacts	Wire size AWG	mm ²	Amp.	Service group	Weight Polychloroprene insert lbs.	gr.	Contact arrangement	No. of contacts	Wire size AWG	mm ²	Amp.	Service group	Weight Polychloroprene insert lbs.	gr.
Shell size 10S/10SL								Shell size 18							
10SL-3	3	16	1,5	22	A	P.010 S.017	4 8	18-8	1 7	12 16	2,5 1,5	41 22	A	P.044 S.062	20 28
10SL-4	2	16	1,5	22	A	P.009 S.014	4 6	18-9	2 5	12 16	2,5 1,5	4 22	Inst.	P.045 S.062	20 28
Shell size 12/12S								Shell size 20							
12S-3	2	16	1,5	22	A	P.010 S.016	5 7	18-10	4	12	2,5	41	A	P.046 S.067	21 30
12-5	1	12	2,5	41	D	P.-	-	18-11	5	12	2,5	41	A	P.049 S.071	22 32
Shell size 14/14S								Shell size 22							
14S-1	3	16	1,5	22	A	P.- S.-	- -	18-12	6	16	1,5	22	A	P.039 S.054	18 24
14S-2	4	16	1,5	22	Inst.	P.019 S.028	9 13	18-13	1	8	10,0	73	A	P.- S.-	- -
14-5	5	16	1,5	22	Inst.	P.017 S.029	8 13	20-1	1	0	50	245	D	P.092 S.101	41 45
14S-6	6	16	1,5	22	Inst.	P.031 S.015	15 7	20-4	4	12	2,5	41	D	P.057 S.086	26 38
14S-7	3	16	1,5	22	A	P.015 S.024	7 11	20-7	8	16	1,5	22	A (C,D,E,F) D (A,B,H,G)	P.053 S.076	26 34
14S-9	2	16	1,5	22	A	P.013 S.022	6 10	20-15	7	12	2,5	41	A	P.068 S.100	30 45
Shell size 16/16S								Shell size 24							
16S-1	7	16	1,5	22	A	P.025 S.042	11 19	20-16	2 7	12 16	2,5 1,5	41 22	A	P.059 S.084	26 38
16-7	1	8	10,0	73	A	P.-	-	20-17	5	12	2,5	41	A	P.068 S.098	31 38
16S-9	5	16	1,5	22	A	P.023	10	20-19	3	8	10,0	73	A	P.068 S.091	31 41
16-9	2	12	2,5	41	A	S.039 P.031	18 14	20-24	2 2	8 16	10,0 1,5	73 22	A	P.062 S.085	28 38
16-10	3	12	2,5	41	A	P.031 S.047	14 21	20-27	14	16	1,5	22	A	P.062 S.082	28 37
16-11	2	12	2,5	41	A	P.028 S.042	13 19	20-29	17	16	1,5	22	A	P.065 S.085	29 38
16-12	1	4	16,0	135	A	P.031 S.047	14 21	20-33	11	16	1,5	22	A	P.057 S.079	25 35
Shell size 18								Shell size 26							
18-1	10	18	1,5	22	A (B,C,F,G) Inst. (all others)	P.044 S.058	20 26	20A9	9	-	2,5	41	D for J	P.020 S.033	9 15
18-3	2	12	2,5	41	D	P.038 S.057	17 26	20A48	19	-	1,5	22	Inst.	P.020 S.036	16
18-4	4	16	1,5	22	D	P.037 S.053	17 24	20-8	4 2	16 8	1,5 10	22 73	Inst.	P.059 S.080	26 36
18-5	2	12	2,5	41	D	P.040 S.059	18 27	Shell size 28							
18-5	1	16	1,5	22	D	P.040 S.059	18 27	22-2	3	8	10	73	D	P.077 S.104	34 47
18-5	1	4	16,0	13,5	D	P.048 S.-	22 -	22-7	1	0	50	245	E	P.101 S.-	-

Contact arrangements

Contact arrangement	No. of contacts	Wire size AWG	mm ²	Amp.	Service group	Weight Polychloroprene insert lbs.	gr.	Contact arrangement	No. of contacts	Wire size AWG	mm ²	Amp.	Service group	Weight Polychloroprene insert lbs.	gr.
Shell size 22								Shell size 28							
22-9	3	12	2,5	41	E	P.062 S.092	28 42	28-11	4 18	12 16	2,5 1,5	41 22	A	P.131 S.182	59 53
22-12	2 3	8 16	10 1,5	73 22	D	P.072 S.100	32 45	28-12	26	16	1,5	22	A	P.127 S.172	57 78
22-14	19	16	1,5	22	A	P.077 S.100	34 45	28-15	35	16	1,5	22	A	P.139 S.181	63 82
22-19	14	16	1,5	22	A	P.070 S.095	31 43	28-20	10 4	12 16	2,5 1,5	41 22	A	P.134 S.196	80 89
22-20	9	16	1,5	22	A	P.063 S.090	29 41	28-21	37	16	1,5	22	A	P.142 S.183	64 83
22-22	4	8	10	73	A	P.085 S.112	38 50	28-2009-16	4 5	4 16	16 1,5	135 22	A	P.- S.-	- -
22-23	8	12	2,5	41	D (H) A (all others)	P.080 S.118	36 53	28A63	19	-	1,5	22	A for E	P.042 S.077	19 35
22-27	1 8	8 16	10 2,5	73 22	A (H) D (J)	P.070 S.097	31 44	Shell size 32							
22-28	7	12	2,5	41	A	P.086 S.120	38 54	32-1	2 3	0 12	50 2,5	245 41	E (A) D (all others)	P.- S.-	- -
Shell size 24								32-5	2	0	50	245	D	P.- S.-	- -
24-2	7	12	2,5	41	D	P.089 S.133	40 60	32-6	2 3 2 16	4 8 12 16	16 10 2,5 1,5	135 73 41 22	A	P.-223 S.287	101 130
24-7	2 14	12 16	2,5 1,5	41 22	A	P.090 S.125	40 56	32-7	7 28	12 16	2,5 1,5	41 22	Inst. (A,B,h,i) D (all others)	P.198 S.274	89 124
24-10	7	8	10	73	A	P.125 S.157	56 71	32-6	6 24	12 16	2,5 1,5	41 22	A	P.189 S.265	86 120
24-11	3 6	8 12	10 2,5	73 41	A	P.111 S.153	50 69	32-17	4	4	16	135	D	P.223 S.283	101 129
24-12	3 2	12 4	10 16	41 135	A	P.027 S.051	12 23	32A69	41 20	- -	1,0 1,5	7,5 22	Inst.	P.119 S.121	54 55
24-19	12	16	1,5	22	A	P.- S.-	- -	Shell size 36							
24-20	2 9	12 16	2,5 1,5	41 22	D	P.083 S.120	37 54	36-5	4	0	50	245	A	P.- S.-	-
24-22	4	8	10	73	D	P.- S.132	- 59	36-10	48	16	1,5	22	A	P.214 S.321	97 145
24-28	24	16	1,5	22	Inst.	P.096 S.126	43 57								

For additional contact arrangements please consult factory.

Wall mounting receptacle



MS3100E / CA3100E MS3100F

MS3100E and F are wall mounting receptacles which mate with 3106 and 3108 plugs.

Note: MS3100E corresponds to MS3100F and is available upon request. For new programs please order MS3100F only.

If crimp version is required please order CA3100E...F80 or CA3100E...F183

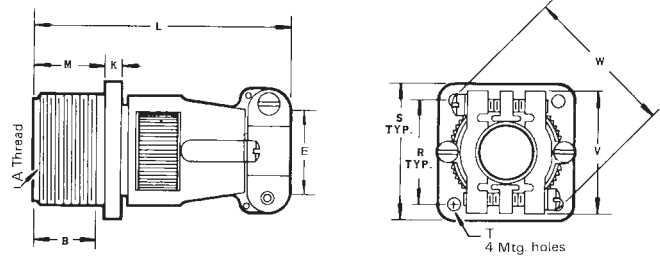

Part Number Pin Insert*	A	B min.	E ¹⁾ max.	K ±0,7	L max.	M +0,4	R ±0,1	S ±0,3	V max.	W max.	T +0,2 -0,1
MS3100E10SL-**P	5/8-24 EF-2A	9,5	6,5	3,0	60	14,2	18,2	25,4	22,7	27,0	3,1
MS3100E-12S-**P	3/4-20UNEF-2A	9,5	6,5	3,0	60	14,2	20,6	28,0	22,7	27,0	3,1
MS3100E14S-**P	1/8-20UNEF-2A	9,5	9,0	3,0	70	14,2	23,0	30,0	27,5	34,0	3,1
MS3100E16S-**P	1 -20UNEF2A	9,5	11,0	3,0	70	14,2	24,6	32,5	30,0	38,0	3,1
MS3100E12-**P	3/4-20UNEF-2A	15,8	6,5	3,0	70	19,0	20,6	28,0	22,7	27,0	3,1
MS3100E14-**P	7/8-20UNEF-2A	15,8	9,0	3,0	70	19,0	23,0	30,0	27,5	34,0	3,1
MS3100E16-**P	1 -20UNEF-2A	15,8	11,0	3,0	70	19,0	24,6	32,5	30,0	38,0	3,1
MS3100E18-**P	1-1/8-18NEF-2A	15,8	14,2	3,9	77	19,0	27,0	35,0	32,2	40,5	3,1
MS3100E20-**P	1-1/4-18NEF-2A	15,8	15,8	3,9	77	19,0	29,4	38,0	37,5	47,5	3,1
MS3100E22-**P	1-3/8-18NEF-2A	15,8	15,8	3,0	77	19,0	31,8	41,0	37,5	47,5	3,1
MS3100E24-**P	1-1/2-18NEF-2A	15,8	21,4	3,9	77	20,6	34,9	44,5	43,3	54,0	3,7
MS3100E28-**P	1-3/4-18NS-2A	15,8	21,4	3,0	85	20,06	39,7	50,8	43,3	54,0	3,7
MS3100E32-**P	1 -18NS-2A	15,8	26,7	3,9	85	22,2	44,5	57,0	51,7	64,5	4,4
MS3100E36-**P	2-1/4-16UN-2A	15,8	31,7	3,9	105	22,2	49,2	63,5	58,0	73,0	4,4

**Add contact arrangement number (see pages 5-11) *For socket inserts substitute S for P ¹⁾ maximum cable diameter



MS3100R / CA3100R

The MS3100R receptacles feature a shorter lightweight endbell and mate with 3106 and 3108 plugs.

If crimp version is required please order CA3100R...F80 or CA3100R...F183

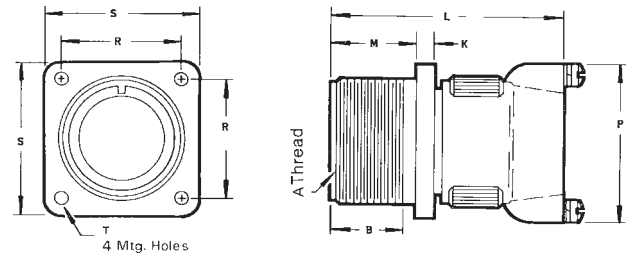

Part Number Pin Insert*	A	B min.	K ±0,7	L max.:	M +0,4	P max.	R ±0,1	S ±0,3	T +0,2 -0,1
MS3100R-10SL-**P	5/8-24NEF-2A	9,5	3,0	45	14,2	24,4	18,2	25,4	3,1
MS3100R-12S-**P	3/4-20UNEF-2A	9,5	3,0	45	14,2	24,4	20,6	28,0	3,1
MS3100R14S-**P	7/8-20UNEF-2A	9,5	3,0	55	14,2	29,0	23,0	30,0	3,1
MS3100R16S-**P	1 -20UNEF-2A	9,5	3,0	55	14,2	31,5	24,6	32,5	3,1
MS3100R12-**P	3/4-20UNEF-2A	15,8	3,0	55	19,0	24,4	20,6	28,0	3,1
MS3100R14-**P	7/8-20UNEF-2A	15,8	3,0	55	19,0	29,0	23,0	30,0	3,1
MS3100R16-**P	1 -20UNEF-2A	15,8	3,0	55	19,0	31,5	24,6	32,5	3,1
MS3100R18-**P	1 1/8-18NEF-2A	15,8	3,9	60	19,0	36,6	27,0	35,0	3,1
MS3100R20-**P	1-1/4-18NEF-2A	15,8	3,9	60	19,0	39,7	29,4	38,0	3,1
MS3100R22-**P	1-3/8-18NEF-2A	15,8	3,9	60	19,0	39,7	31,8	41,0	3,1
MS3100R24-**P	1-1/2-18NEF-2A	15,8	3,9	60	20,6	47,4	34,9	44,5	3,7
MS3100R26-**P	1-3/4-18 S-2A	15,8	3,9	67	20,6	47,4	39,7	50,8	3,7
MS3100R32-**P	2 -18NS-2A	15,8	3,9	67	22,2	55,9	44,5	57,0	4,4
MS3100R36-**P	2-1/4-16UN-2A	15,8	3,9	85	22,2	60,8	49,2	63,5	4,4

**Add contact arrangement number (see pages 5-11) *For socket inserts substitute S for P

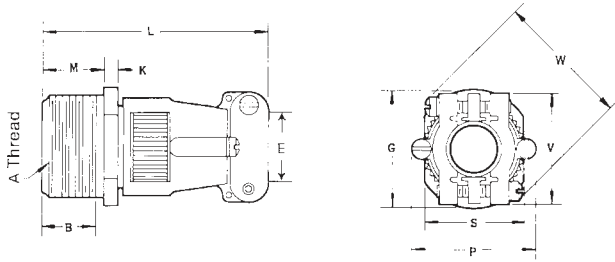

MS3101E/CA3101E MS3101F

MS3101E and F are cable connecting plugs without flange and coupling nut. MS3101E and F mate with 3106 and 3108 plugs.

For new programs order MS3101F only.
If crimp version is required please order CA3101E...F80 or CA3101E...183

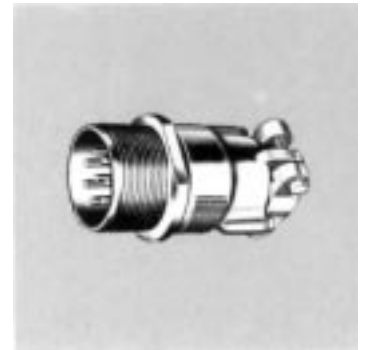

Part Number	A	B	E ¹⁾	G	K	L	M	P	S	V	W
Pin Insert*		min.	max.	max.	±0,7	max.	+0,4	max.	max.	max.	max.
MS3101E10SL-**P	5/8-2UNEF-2A	9,5	6,5	21,8	3,0	60	14,2	24,4	16,2	22,7	27,6
MS3101E12S-**P	3/4-20UNEF-2A	9,5	6,5	25,0	3,0	60	14,2	24,4	19,3	22,7	27,0
MS3101E14S-**P	7/8-20UNEF-2A	9,5	9,0	28,2	3,0	70	14,2	28,8	22,5	27,5	34,0
MS3101E16S-**P	1 -20U EF-2A	9,5	11,0	31,4	3,0	70	14,2	31,5	25,6	30,0	38,0
MS3101E12-**P	3/4-20UNEF-2A	15,8	6,5	25,0	3,0	70	19,0	24,4	19,3	22,7	27,0
MS3101E14-**P	7/8-20UNEF-2A	15,8	9,0	28,2	3,0	70	19,0	29,0	22,5	27,5	34,0
MS3101E16-**P	1 -20UNEF-2A	15,8	11,0	31,4	3,0	70	19,0	31,5	25,6	30,0	38,0
MS3101E18-**P	1-1/8-18NEF-2A	15,8	14,2	34,5	3,9	77	19,0	36,6	28,8	32,2	40,5
MS3101E20-**P	1-1/4-18NEF-2A	15,8	15,8	37,6	3,9	77	19,0	39,7	32,0	37,5	47,5
MS3101E22-**P	1-3/8-18NEF-2A	15,8	15,8	41,0	3,9	77	19,0	39,7	35,2	37,5	47,5
MS3101E24-**P	1-1/2-18NEF-2A	15,9	21,4	43,8	3,9	77	20,6	47,4	38,4	43,3	54,0
MS3101E28-**P	1-3/4-18NS-2A	15,8	21,4	50,5	3,9	85	20,6	47,4	44,8	43,3	54,0
MS3101E32-**P	2 -18NS-2A	15,8	26,7	57,0	3,9	85	22,2	55,9	51,2	51,7	64,5
MS3101E36-**P	2-1/4-16UN-2A	15,8	31,7	63,2	3,9	1k05	22,2	60,8	57,5	58,0	73,0

**Add contact arrangement number (see pages 5-11) *For socket inserts substitute S for P ¹⁾ maximum cable diameter

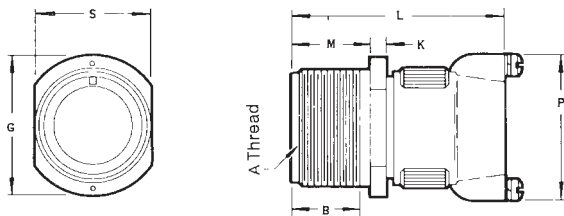

MS3101R / CA3101R

MS3101 cable connecting plugs without coupling nut feature a shorter and light-weight endbell than MS3101E and mate with 3106 and 3108 plugs.

If crimp version is required please order CA3101R..F80 or CA3101R...F183



Part Number	A	B	G	K	L	M	P	S
Pin Insert*		min.	max.	±0,7	max.	+0,4	max.	max
MS3101R10SL-**P	5/8-24NEF-2A	9,5	21,8	3,0	45	14,2	24,4	16,2
MS3101R12S-**P	3/4-20UNEF-2A	9,5	25,0	3,0	45	14,2	24,4	19,9
MS3101R14S-**P	7/8-20UNEF-2A	9,5	28,2	3,0	55	14,2	29,0	22,5
MS3101R16S-**P	1 -20UNEF-2A	9,5	31,4	3,0	55	14,1	31,5	25,6
MS3101R12-**P	3/4-0UNEF-2A	15,8	25,0	3,0	55	19,0	24,4	19,3
MS3101R14-**P	7/8-20UNEF-2A	15,8	28,2	3,0	55	19,0	29,0	22,5
MS3101R16-**P	1 -20UNEF-2A	15,8	31,4	3,0	55	19,0	31,5	25,6
MS3101R18-**P	1-1/8-18NEF-2A	15,8	34,5	3,9	60	19,0	36,6	28,8
MS3101R20-**P	1-1/4-18NEF-2A	15,8	37,6	3,9	60	19,0	39,7	32,0
MS3101R22-**P	1-3/8-18 EF-2A	15,8	41,0	3,0	60	19,0	39,7	35,2
MS3101R24-*P	1-1/2-18NEF-2A	15,8	43,8	3,9	60	20,6	47,4	38,4
MS3101R28.**P	1-3/4-18NS-2A	15,8	50,5	3,9	67	20,6	47,4	44,8
MS3101R32-**P	2 -18NS-2A	15,8	57,0	3,9	67	22,2	55,9	51,2
MS3101R36-**P	2-1/4-16UN-2A	15,8	63,2	3,9	85	22,2	60,8	57,5

*Add contact arrangement number (see pages 5-11) *For socket inserts substitute S for Pin

Box Mounting Receptacles / Straight Plugs



MS3102E MS3102R

MS3102E and R are box mounting receptacles with square flange and mate with 3106 and 3108 plugs.

Shell size	X Dimension Max. Solder Pot Extension - Pin or Socket Contact Size			
	16	12	8	4
10SL	13,6	-	-	-
12S, 14S, 16S	13,2	-	-	-
12	17,9	17,9	-	-
14	17,9	17,9	19,5	-
16	17,9	17,9	19,5	-
18	17,1	17,1	18,7	18,7
20, 22	17,1	17,1	18,7	18,7
24, 28	15,5	15,5	17,1	17,1
32, 36	13,9	13,9	15,5	15,5

CA3102E

If crimp version is required please order CA3102R...F80 or CA3102R...F183.

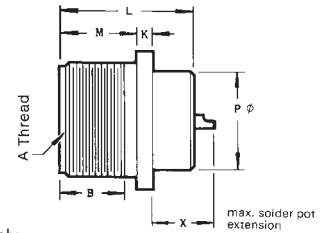
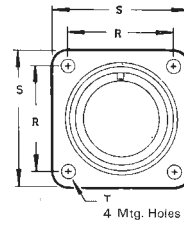

Note: For new programs order MS3102R only.

Part Number Pin Insert*	A	B min.	K ±0,7	L max.	M +0,4	P max.	R ±0,1	S ±0,3	T +0,2 -0,2
MS3102R10SL-**P	5/8-24NEF-2A	9,5	3,0	25,1	14,2	15,9	18,2	25,4	3,1
MS3102R12S-**P	3/4-20UNEF-2A	9,5	3,0	25,1	14,2	15,9	20,6	28,0	3,1
MS3102R14S-**P	7/8-20UNEF-2A	9,5	3,0	25,1	14,2	19,0	23,0	30,0	3,1
MS3102R16S-**P	1 -20U EF-2A	9,5	3,0	25,1	14,2	22,2	24,6	32,5	3,1
MS3102R16S-**P	1 -20UNEF-2A	9,5	3,0	25,1	14,2	22,2	24,6	32,5	3,1
MS3102R12-**P	3/4-20UNEF-2A	15,8	3,0	34,6	19,0	15,9	20,6	28,0	3,1
MS3102R14-**P	7/8-20UNEF-2A	15,8	3,0	34,6	19,0	19,0	23,0	30,0	3,1
MS3102R16-**P	1 -20UNEF2A	15,8	3,0	34,6	19,0	22,2	24,6	32,5	3,1
MS3102R18-**P	1-1/8-18NEF-2A	15,8	3,9	34,6	19,0	25,4	27,0	35,0	3,1
MS3102R20-**P	1-1/4-18NEF-2A	15,8	3,9	34,6	19,0	29,0	29,4	38,0	3,1
MS3102R22-**P	1-3/8-18NEF-2A	15,8	3,9	34,6	19,0	32,2	31,8	41,0	3,1
MS3102R24-**P	1-1/2-18NEF-2A	15,8	3,9	36,2	20,6	35,3	34,9	44,5	3,7
MS3102R28-**P	1-3/4-18NS-2A	15,8	3,9	36,2	20,6	41,2	39,7	50,8	3,7
MS3102R32-**P	2 -18NS-2A	15,8	3,9	37,8	22,2	47,6	44,5	57,0	4,4
MS3102R36-**P	2-1/4-16UN-2A	15,8	3,9	37,8	22,2	52,4	49,2	63,5	4,4

**Add contact arrangement number (see pages 5-11) *For socket inserts substitute S for P



MS3106E / CA3106E MS3106F / CA06R

MS3106E and F are straight plugs. They mate with 3100 and 3102 receptacles and 3101 plugs.

Note:
MS3106E corresponds to MS3106F, however MS3106F has an O ring seal. For new programs order MS3101F only.

If crimp version is required please order CA3106E...F80 (without O ring), CA3106E...F183(without O ring) or CA06R...F183 (with O ring).

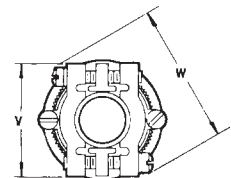
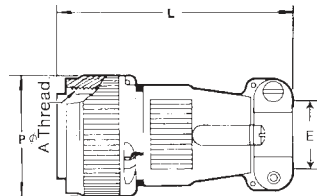

Part Number Pin Insert	A	E ¹⁾ max.	L max.	P max.	V max.	W max.
MS3106E10SL-**P	5/8-24NEF-2B	6,5	55,0	24,1	22,7	27,0
MS3106E12S-**P	3/4-20UNEF-2B	6,5	55,0	25,8	22,7	27,0
MS3106E14S-**P	7/8-20UNEF-2B	9,0	60,0	28,8	27,5	34,0
MS3106E16-**P	1 -20UNEF-2B	11,0	60,0	31,8	30,0	38,0
MS3106E12-**P	3/4-20UNEF-2B	6,5	70,0	25,6	22,7	27,0
MS3106E14-**P	7/8-20UNEF-2B	9,0	70,0	28,8	27,5	34,0
MS3106E16-**P	1 -20UNEF-2B	11,0	70,0	31,8	30,0	38,8
MS3106E18-**P	1-1/8-18NEF-2B	14,2	75,0	34,1	32,2	40,5
MS3106E20-**P	1-1/4-18NEF-2B	15,8	75,0	37,4	37,5	47,5
MS3106E22-**P	1-3/8-18NEF-2B	15,8	75,0	40,5	37,5	47,0
MS3106E24-**P	1-1/2-18NEF-2B	21,4	75,0	43,8	43,3	54,0
MS3106E28-**P	1-3/4-18NS-2B	21,4	90,0	50,2	43,3	73,0
MS3106E32-**P	2 -18NS-2B	26,7	90,0	56,4	51,7	64,5
MS3106E36-**P	2-1/4-16UN-2B	31,7	100,0	62,8	58,0	73,0

**Add contact arrangement number (see pages 5-11) *For socket inserts substitute S for P ¹⁾maximum cable diameter

MS3106R / CA3106R

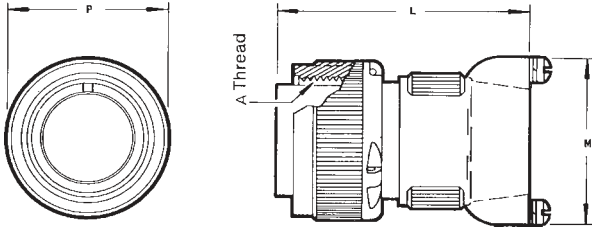

The MS3106R straight plug has a shorter lightweight endbell than MS3106E and F. It contains an O ring seal under the coupling nut. MS3106R plugs mate with 3100 and 3102 receptacles and 3101 plugs.

If crimp version is required please order CA3106R...F80 or CA3106R...183

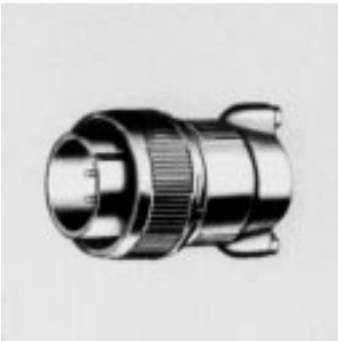

Part Number	A	L	M	P
Pin Insert		max.	max.	max.
MS3106R10SL-**P	5/8-24NEF-2B	40,0	24,4	24,1
MS3106R12S-**P	3/4-20UNEF-2B	40,0	24,4	25,8
MS3106R14S-**P	7/8-20UNEF-2B	45,0	29,0	28,8
MS3106R16S-**R	1 -20UNEF-2B	45,0	31,5	31,8
MS3106R12-**P	3/4-20U EF-2B	55,0	24,4	25,8
MS3106R14-**P	7/820UNEF2B	55,0	29,0	28,8
MS3106R16-**P	1 -20UNEF-2B	55,0	31,5	31,8
MS3106R18-**P	1-1/8-18NEF-2B	60,0	36,5	34,1
MS3106R20-**P	1-1/4-18 EF-2B	60,0	39,7	37,4
MS3106R22-**P	1-3/8-18NEF-2B	60,0	39,7	40,5
MS3106R24-**P	1-1/2-18 EF-2B	60,0	47,4	43,6
MS3106R28-**P	1-3/4-18NS-2B	70,0	47,4	50,2
MS3106R32-**P	2 -18NS-2B	70,0	55,9	56,4
MS3106R36-**P	2-1/4-16UN-2B	90,0	60,8	62,8

**Add contact arrangement number (see pages 5-11) *For socket inserts substitute S for P

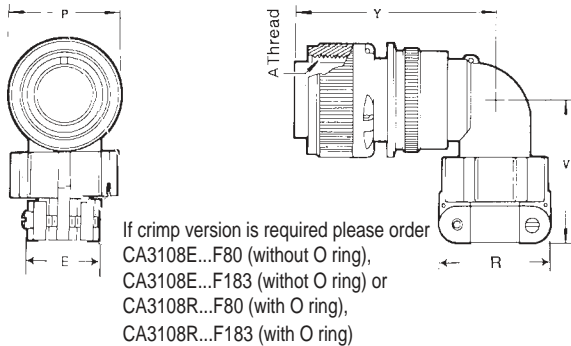

MS3108E / CA3108E MS3108R / CA3108R

MS3108R 90° right angle plugs mate with 3100 and 3102 receptacles and 3101 plugs. The 3108R has an O ring seal under the coupling nut. If no O ring is required the order reference is MS3108E.

Note: MS3108R is without cable clamp. If it is required with cable clamp please order the clamp separately.



Part Number	A	E ¹⁾	P	R	V	Y
Pin Insert		max.	max.	max.	max.	max.
MS3108R10SL-**P	5/8-25NEF-2B	6,5	24,1	22,7	42,0	45,0
MS3108R12S-**P	3/4-20UNEF-2B	6,5	25,8	22,7	42,0	45,0
MS3108R14S-**P	7/8-20UNEF-2B	9,0	28,8	27,5	42,0	47,0
MS3108R16S-**R	1 -20UNEF-2B	11,0	31,8	30,0	45,0	48,0
MS3108R12-**P	3/4-20UNEF-2B	6,5	25,8	22,7	54,0	54,0
MS3108R14-**P	7/8-20UNEF-2B	9,0	28,8	27,5	35,7	55,0
MS3108R16-**P	1 -20UNEF-2B	11,0	31,8	30,0	45,0	57,0
MS3108R18-**P	1-1/8-18NEF-2B	14,2	34,1	32,2	53,0	58,0
MS3108R20-**P	1-1/4-18NEF-2B	15,8	37,4	37,5	53,0	61,0
MS3108R22-**P	1-3/8-18NEF-2B	15,8	40,5	37,5	53,0	61,0
MS3108R24-**P	1-1/2-18NEF-2B	21,4	43,8	43,3	58,0	66,0
MS3108R26-**P	1-3/4-18NS-2B	21,4	50,2	43,3	58,0	66,0
MS3108R32-**P	2 -18NS-2B	26,7	56,4	51,7	66,0	72,0
MS3108R36-**P	2-1/4-16UN-2B	31,7	62,8	58,0	69,0	75,0

**Add contact arrangement number (see pages 5-11) *For socket inserts substitute S for P ¹⁾ maximum cable diameter

Straight Plugs - F Type / Cable Connecting Plug - F Type



CA3106F

CA3106F is a straight plug with external thread, however without cable clamp and O ring seal. Crimp and solder versions are available (please indicate ...F80 ore ...F183). CA3106F mate with 3100, 3101 and 3102 shell styles.

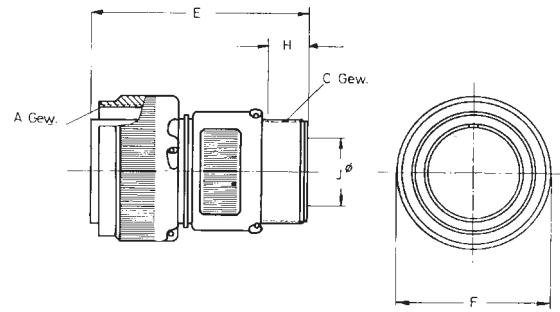

Part Number	A Thread	C Thread	E	F	J	H
Pin Insert			max.	max.	min.	min.
CA3106F10SL-**	5/8-243 EF-2B	5/8-24 EF-2A	50,0	24,1	8,2	9,5
CA3106F12S-**P	3/4-20UNEF-2B	5/8-24NEF2A	50,0	25,8	8,2	9,5
CA3106F14S-**P	7/8-20UNEF-2B	3/4-20UNEF	50,0	28,8	11,1	9,5
CA3106F16S-**P	1 -20UNEF-2B	7/8-20UNEF-2A	50,0	31,8	14,3	9,5
CA3106F12-**P	3/4-20UNEF-2B	5/8-24NEF-2A	60,0	25,8	8,2	9,5
CA3106F14-**P	7/8-20UNEF-2B	3/4-20UNEF-2A	60,0	28,8	11,1	9,5
CA3106F16-**P	1 -20UNEF-2B	7/8-20UNEF-2A	60,0	31,8	14,3	9,5
CA3106F18-**P	1-1/8-18NEF2B	1 -20UNEF-2A	60,0	34,1	16,7	9,5
CA3106F20-**P	1-1/4-18NEF-2B	1-3/16-18NEF-2A	60,0	37,4	19,8	9,5
CA3106F22-**P	1-3/8-18NEF-2B	1-3/16-18NEF-2A	60,0	40,5	19,8	9,5
CA31.06F24-**P	1-1/2-18NEF-2B	1-7/16-18NEF-2A	65,0	43,8	25,4	9,5
CA3106F28-**P	1-3/4-18NS-2B	1-7/16-18NEF-2A	65,0	50,2	27,0	9,5
CA3106F32-**P	2 -18NS-2B	1-3/4-18NS-2A	65,0	56,4	32,5	11,0
CA3106F36-**P	2-1/4-16UN-2B	2 -18NS-2A	80,0	62,8	35,7	11,8

**Add contact arrangement number (see pages 5-11) *For socket inserts substitute S for P



CA3101F

CA3101F is a cable connecting plug with threaded endbell. Crimp and solder versions are available (please indicate ...F80 ore ...F183). CA3101F mate with 3106 and 3108 shell styles.

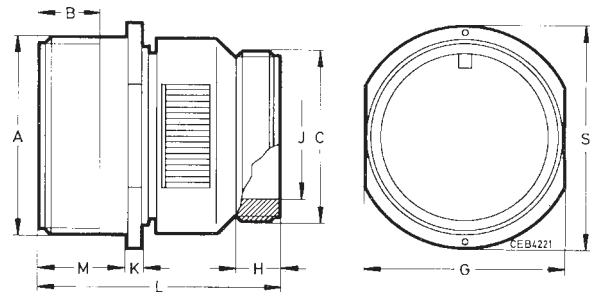

Part Number	A Thread	C Thread	B	H	G	K	L	M	J Ø	S
Pin Insert			min.	min.	max.	±0,7	max.	+0,4	min.	max.
CA3101F10SL-**P	5/8-24NEF-2A	5/8-24NEF-2A	9,5	9,5	16,2	3,0	45,0	14,2	8,2	21,8
CA3101F12S-**P	3/4-20UNEF-2A	5/8-24NEF-2A	9,5	9,5	19,3	3,0	45,0	14,2	8,2	25,0
CA3101F14S-**P	7/8-20UNEF-2A	3/4-20UNEF-2A	9,5	9,5	22,5	3,0	45,0	14,2	11,1	28,2
CA3101F16S-**P	1 -20UNEF-2A	7/8-20UNEF-2A	9,5	9,5	25,6	3,0	45,0	14,2	14,3	31,4
CA3101F12-**P	3/4-20UNEF-2A	5/8-24NEF-2A	15,8	9,5	19,3	3,0	57,0	19,0	8,2	25,0
CA3101F14-**P	7/8-20UNEF-2A	3/4-20UNEF-2A	15,8	9,5	22,5	3,0	57,0	19,0	11,1	29,2
CA3101F16-**P	1 -20UNEF-2A	7/8-20UNEF-2A	15,8	9,5	25,6	3,0	57,0	19,0	14,3	31,4
CA3101F18-**P	1-1/8-18 EF-2A	1 -20UNEF-2A	15,8	9,5	28,8	3,9	57,0	19,0	16,7	34,5
CA3101F20-**P	1-1/4-18NEF-2A	1-3/16-18NEF-2A	15,8	9,5	32,0	3,9	57,0	19,0	19,8	37,6
CA3101F22-**P	1-3/8-18NEF-2A	1-3/16-18NEF-2A	15,8	9,5	35,2	3,9	57,0	19,0	19,8	41,0
CA3101F24-**P	1-1/2-18NEF-2A	1-7/16-18NEF-2A	15,8	9,5	38,4	3,9	57,0	20,6	25,4	43,8
CA3101F28-**P	1-3/4-18NS-2A	1-7/16-18NEF-2A	15,8	9,5	44,8	3,9	62,0	20,6	27,0	50,5
CA3101F32-**P	2 -18NS-2A	1-3/4-18NS-2A	15,8	11,0	51,2	3,9	62,0	22,2	32,5	57,9
CA3101F36-**P	2-1/4-16UN-2A	2 -18NS-2A	15,8	11,8	57,5	3,9	62,0	22,2	35,7	53,2

**Add contact arrangement number (see pages 5-11) *For socket inserts substitute S for P

Straight Plugs with Shrink Boot Adapter / Through Bulkheads

CA3106-DN

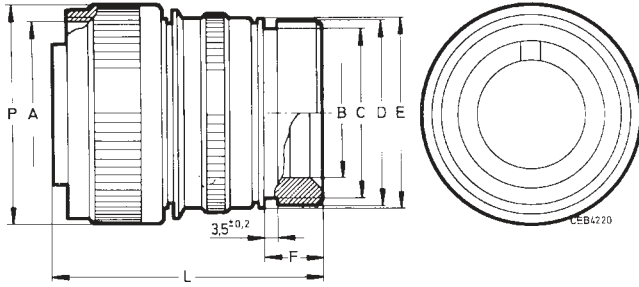

CA3106-DN is a straight plug with endbell for shrink boot adapters. Crimp and solder versions are available (please indicate ...F80 ore ...F183). CA3106-DN mate with 3100, 3101 and 3102 shell styles.



Part Number	A Thread	B	C	D	E	F	L	P
Pin Insert		min.	max.	±0,2	±0,2	±0,5	max.	max.
CA3106E10SL-**-P-DN	5/8-24NEF-2B	7,7	13,2	15,5	17,0	11,7	11,7	50,0
CA3106E12S-**-P-DN	3/4-20UNEF-2B	7,9	13,2	15,5	17,8	11,8	58,8	25,6
CA3106E14S-**-P-DN	7/8-20UNEF-2B	10,6	17,0	19,1	19,1	11,7	50,0	28,6
CA3106E16S-**-P-DN	1 -20UNEF-2B	13,5	21,9	23,9	23,9	11,5	50,0	31,8
CA3106E12-**-P-DN	3/4-20UNEF-2B	7,9	13,2	15,5	17,8	11,7	50,0	25,6
CA3106E14-**-P-DN	7/8-20UNEF-2B	10,6	17,0	19,1	20,1	11,7	60,0	28,6
CA3106E16-**-P-DN	1 -20UNEF-2B	13,5	21,9	23,9	23,5	11,5	60,0	31,8
CA3106E18-**-P-DN	1-1/8-18NEF-2B	14,6	21,9	23,9	26,5	12,7	60,0	34,1
CA3106E20-**-P-DN	1-1/4-18NEF-2B	18,5	26,6	29,6	30,2	12,7	65,0	37,3
CA3106E22-**-P-DN	1-3/8-18NEF-2B	20,8	26,2	29,6	33,6	12,7	65,0	40,5
CA3106E24-**-P-DN	1-1/2-16NEF-2B	24,6	34,5	37,8	36,1	12,7	65,0	43,8
CA3106E28-**-P-DN	1-3/4-18NS-2B	27,0	34,5	37,8	41,4	12,7	65,0	50,0
CA3106E32-**-P-DN	2 -18NS-2B	33,3	43,6	47,8	48,6	15,2	70,0	56,3
CA3106E36-**-P-DN	2-1/4-16UN-2B	38,5	43,6	47,8	54,8	15,2	80,0	62,7

**Add contact arrangement number (see pages 5-11) *For socket inserts substitute S for P

TBF

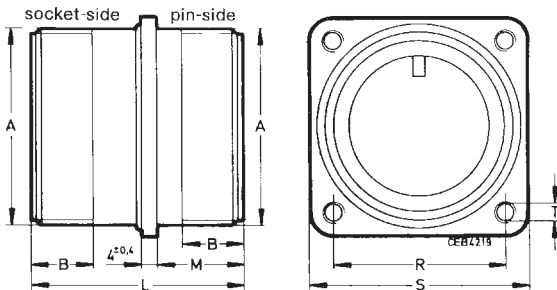

TBF is a through-bulkhead which mates with 3106 and 3108 plugs.

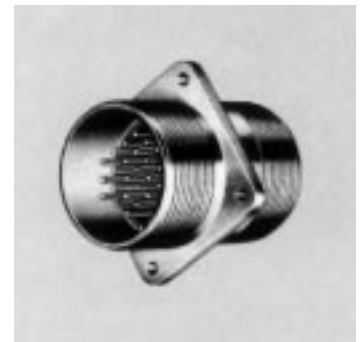

Part Number	A Thread	B	L	M	R	S	T
Pin and Socket Insert		min.	max.	+0,4	±0,1	±0,3	+0,2 -0,1
TBF10SL-**PS	5/8-24NEF-2A	9,5	40,1	14,2	18,2	25,4	3,1
TBF12S-**PS	3/4-20UNEF-2A	9,5	40,1	14,2	20,6	28,0	3,1
TBF14S-**PS	7/8-20UNEF-2A	9,5	40,1	14,2	23,0	30,0	3,1
TBF16S-**PS	1 -20UNEF-2A	9,5	40,1	14,2	24,6	32,5	3,1
TBF12-**PS	3/4-20UNEF-2A	15,8	54,4	19,0	20,6	28,0	3,1
TBF14-**PS	7/8-20UNEF-2A	15,8	54,4	19,0	23,0	30,0	3,1
TBF16-**PS	1 -20UNEF-2A	15,8	54,4	19,0	24,6	32,5	3,1
TBF18-**PS	1-1/8-18NEF-2A	15,8	54,5	19,0	27,0	35,0	3,1
TBF20-**PS	1-1/4-18NEF-2A	15,8	54,5	19,0	29,4	38,0	3,1
TBF22-**PS	1-3/8-18NEF-2A	15,8	54,5	19,0	31,8	41,0	3,1
TBF24-**PS	1-1/2-18NEF-2A	15,8	54,5	20,5	34,9	44,5	3,7
TBF28-**PS	1-3/4-18NS-2A	15,8	54,5	20,6	39,7	50,8	3,7
TBF32-**PS	2 -18NS-2A	15,8	54,5	22,2	44,5	57,0	4,4
TBF36-**PS	2-1/4-16UN-2A	15,8	54,5	22,2	49,2	63,5	4,4

**Add contact arrangement number (see pages 5-11) *For socket inserts substitute S for P

EA / EB Moisture and weatherproof



CA06EA

Straight plug with gland nut sealing adapter and cable clamp. These plugs for jacketed cables incorporate an adapter for sealing and cable strain relief. A cable clamp is provided for additional support. CA06EA is completely moisture and weatherproof by means of a grommet around the cable and O rings under the coupling nut and where the adapter joins the barrel. Additional sealing is provided by the resilient inserts. Solder and crimp versions are available, please add ...F80 or ...F183. CA06EA mates with 3100, 3101 and 3102 shell styles.

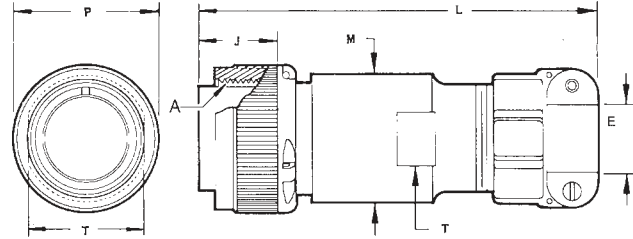

Part Number	A	E cable dia.		L	M	W	P	T
Pin Insert *	Thread	max.	min.	max.	max.	max.	max.	-0,4
CA06EA10SL-**P	5/8-24NEF-2B	8,0	3,3	99,0	20,2	27,0	24,1	16,2
CA06EA12S-**P	3/4-20UNEF-2B	8,0	3,3	99,0	21,2	27,0	25,8	16,2
CA06EA14S-**P	7/8-20UNEF-2B	11,2	5,3	102,0	24,2	34,0	28,8	20,2
CA06EA16-S-**P	1 -20UNEF-2B	13,5	8,1	102,0	27,2	38,0	31,8	23,2
CA06EA12-**P	3/4-20UNEF-2B	8,0	3,3	108,0	21,2	27,0	25,8	16,2
CA06EA14-**P	7/8-20UNEF-2B	11,2	5,3	110,0	24,2	34,0	28,8	20,2
CA06EA16-**P	1 -20UNEF-2B	13,5	8,1	112,0	27,2	38,0	31,8	23,2
CA06EA18-**P	1-1/8-18NEF-2B	15,9	10,9	112,0	32,2	40,5	34,1	27,2
CA06EA20-**P	1-1/4-18NEF-2B	19,1	11,9	112,0	35,2	47,5	37,4	31,2
CA06EA22-**P	1-3/8-18NEF-2B	19,1	11,9	112,00	37,2	47,5	40,5	32,2
CA06EA24-**P	1-1/2-18NEF-2B	23,9	17,0	115,0	41,2	54,0	43,8	37,2
CA06EA28-**P	1-3/4-18NS-2B	23,9	17,0	115,0	47,2	54,0	50,2	41,2
CA06EA32-**P	2 -18NS-2B	31,8	24,4	120,0	53,2	54,5	56,4	46,2
CA06EA36-**P	2-1/4-16UN-2B	34,9	27,4	120,0	59,2	73,0	62,8	52,2

**Add contact arrangement number (see pages 5-11) *For socket inserts substitute S for P



CA06EB

Straight plug with adapter and gland nut. These plugs for jacketed cables incorporate an adapter for sealing and cable strain relief. Instead of a cable clamp a gland nut is supplied at the back of the adapter. An additional support with a Kellems strain relief grip can also be easily adapted to the CA06EB. For complete information on the Kellems grip please consult factory. CA06EB mates with 3100, 3101 and 3102 shell styles.

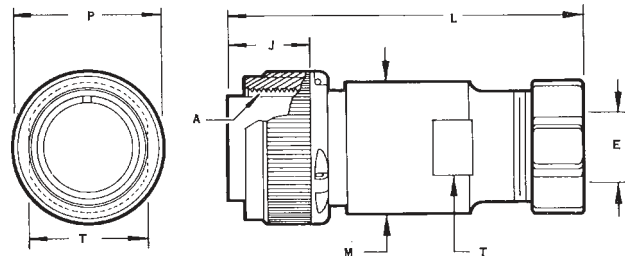

Part Number	A	E cable dia.		L	M	P	T
Pin Insert*	Thread	max.	min.	max.	max.	max.	-0,4
CA06EB10SL-**P	5/8-24NEF-2B	8,0	3,3	85,0	20,2	24,1	16,2
CA06EB12S-**P	3/4-20UNEF-2B	8,0	3,3	85,0	21,2	25,8	16,2
CA06EB14S-**P	7/8-20UNEF	11,2	5,3	87,0	24,2	28,8	20,2
CA06EB16S-**P	1 -20UNEF-2B	13,5	8,1	87,0	27,2	31,8	23,2
CA06EB12-**P	3/4-20UNEF-2B	8,0	3,3	93,0	21,2	25,8	16,2
CA06EB14-**P	7/8-20UNEF-2B	11,2	5,3	95,0	24,2	28,8	20,2
CA06EB16-**P	1 -20UNEF-2B	13,5	6,1	97,0	27,2	31,8	23,4
CA06EB18-**P	1-1/8-18NEF-2B	15,9	10,9	97,0	32,2	34,1	27,2
CA06EB20-**P	1-1/4-18NEF-2B	18,1	11,9	97,0	35,2	37,4	31,2
CA06EB22-**P	1-3/8-18NEF-2B	19,1	11,9	97,0	37,2	40,5	32,2
CA06EB24-**P	1-1/2-18NEF-2B	23,9	17,0	98,0	41,2	43,8	37,2
CA06EB28-**P	1-3/4-18NS-2B	23,9	17,0	98,0	47,2	50,2	41,2
CA06EB32-**P	2 -18NS-2B	31,8	24,4	100,0	53,2	56,4	46,2
CA06EB36-**P	2-1/4-16UN-2B	34,9	27,4	100,0	59,2	62,8	52,2

**Add contact arrangement number (see pages 5-11) *For socket inserts substitute S for P

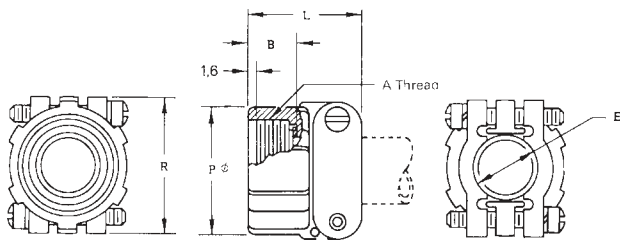

Cable Clamp without Bushing

Cable clamp with or without bushing. To order bushing, add „with bushing“ after the part number.

For example:
MS3057-10A with bushing.



Part No.	Shell Size	A	B max.	E max.	L max.	R max.	Shell Weight gr
MS3057-4A	10S, 12S, 12	5/8-24NEF-2B	10,5	7,9	20,8	22,5	13,2
MS3057-6A	14S, 14	3/4-20UNEF-2B	10,5	11,1	22,4	27,4	18,6
MS3057-8A	16S, 16	7/8-20UNEF-2B	10,5	14,2	24,0	29,8	23,6
MS3057-10A	18	1 -20UNEF-2B	10,5	15,8	24,0	32,2	27,3
MS3057-12A	20, 22	1-3/16-18NEF-2B	10,5	19,0	24,0	37,4	37,2
MS3057-16A	24, 26	1-7/16-18NEF-2B	10,5	23,7	26,4	43,5	56,3
MS3057-20A	32	1-3/4-18NS-2B	12,0	31,8	28,0	51,7	83,9
MS3057-24A	36	2 -18NS-2B	13,7	34,6	29,6	57,8	109,8

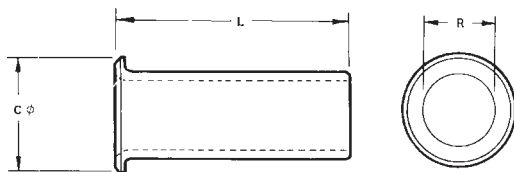

Telescoping Bushing

Telescoping gland bushings (used with cable clamp MS3057A) keep dirt, oil and moisture out of endbell. Taping or wrapping wires is eliminated since bushing protects wires going through clamp. Combinations of bushings may be used to decrease cable entry diameter to improve sealing. Material is polychloroprene (MS).

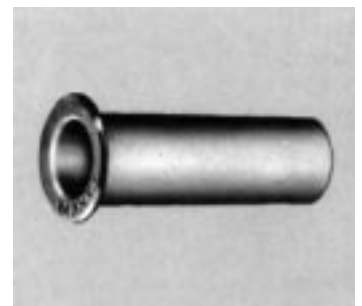

Part No.	Shell Size	C max.	L max.	R -0,3	S -0,3
812-8552-000	10SL, 12, 12S	10,0	70,4	6,7	8,1
012-8554-000	14, 14S	12,8	67,4	9,2	11,0
012-0218-000	16, 16S	18,9	63,9	11,2	14,2
012-0219-000	18	22,1	60,6	14,4	15,8
012-0220-000	20, 22	27,0	57,4	16,0	18,9
012-8555-000	24, 28	27,0	57,4	16,78	21,3

Part No.	Shell Size	C max.	L max.	R -0,3	S -0,3
012-8556-000		33,5	54,4	21,6	23,7
012-8557-000	32	33,05	54,4	21,6	26,6
012-8558-000		40,5	51,4	26,9	31,6
012-8556-000	36	40,5	51,4	26,9	31,6
012-0223-000		47,0	48,4	31,9	34,8

Sealing Gasket

These sealing gaskets made of neoprene are used with flanged receptacles for sealing between the shell and the flange.

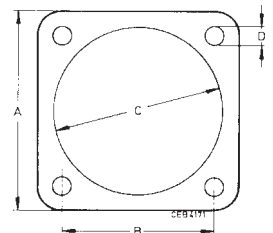

Part No.	MS shell size	A ±0,1	B ±0,3	C ±0,2	D +0,2
075-8512-000	10SL	25,4	18,2	15,7	4,2
075-8513-000	12S, 12	28,0	20,6	18,9	4,2
075-8514-000	14S, 14	30,0	23,0	22,1	3,2
075-8515-000	16S, 16	32,5	24,6	25,3	4,2
075-8516-000	18	35,0	27,0	28,4	4,2
075-8517-000	20	38,0	29,4	31,6	4,2

Part No.	MS shell size	A ±0,1	B ±0,3	C ±0,2	D +0,2
075-8518-000	22	41,0	31,8	34,8	4,2
075-8519-000	24	44,5	34,9	38,0	4,2
075-8520-000	28	50,8	39,7	44,3	5,2
075-8521-000	32	57,0	44,5	50,7	5,2
075-8522-000	36	64,5	49,2	57,0	5,2

Accessories



Plastic protective caps

Material: Polyethylene
Colour: Red

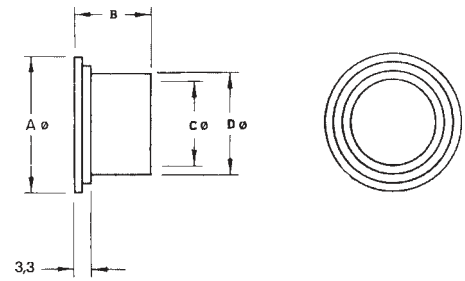

Part Number	MS3100 3101 3102	MS3106 3108	A	B	C	D
			max.	max.	±0,2	max.
025-0460-000	10SL		21,5	17,8	15,2	16,9
025-0477-000		10 SL	20,4	12,5	14,0	15,7
025-0478-000		12S, 12	23,1	14,6	16,8	18,5
025-0462-000	12S, 12		24,7	17,8	18,5	20,2
025-0479-000		14S, 14	26,3	14,6	19,9	21,6
025-0463-000	14S, 14		27,8	17,8	21,6	23,3
025-0480-000		16S, 16	29,5	14,6	23,1	24,8
025-0498-000	16S, 16		31,5	17,8	25,1	26,8
025-0484-000		18	32,8	14,6	25,9	27,8
025-0507-000	18		34,7	17,8	28,2	30,1
025-0467-000		20	35,4	17,8	28,3	30,2
025-0468-000	20		38,1	17,8	31,8	33,4
025-0469-000	22		39,1	14,6	32,6	34,2
025-0486-000		22	41,4	17,8	34,5	36,5
025-0487-000		24	42,3	14,6	35,5	37,4
025-0510-000	24		44,2	17,8	37,8	39,8
025-0488-000		28	48,4	14,6	41,6	43,5
025-0501-000	28		50,4	17,8	43,9	45,9
025-0489-000		32	54,8	14,6	48,0	49,9
025-0502-000	32		57,0	17,8	50,3	52,2
025-0490-000		36	61,3	14,6	54,2	56,3
025-0503-000	36		63,4	17,8	56,6	58,6

Dust caps for mating side of plugs only.

Crimp pot adapters

When cables and contacts of different sizes are used, we offer reduction sleeves. When using reduction sleeves please note that the insulation diameter of the wire has to be within the range of wires shown on page... If this dimension is not being kept it can not be assured that the connector styles 3100, 3101, 3106 and 3108 will be waterproof.

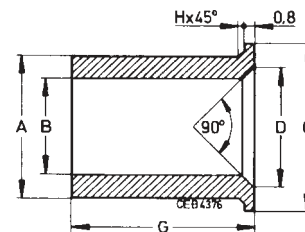

Part Number	suitable for contact size	reduced to wire size	Ø A ca.	Ø B ca.	Ø C ca.	Ø C ca.	G ca.
252-8501-000	8	1,5 mm ²	4,4	1,75	6,4	2,75	10,5
252-8502-000	8	AWG12	4,4	2,5	6,4	4,1	10,5
252-8503-000	100	6 mm ²	4,6	3,4	6,4	4,0	10,5
252-8504-000	15S/15, 16S/16	0,5 mm ²	1,7	1,05	2,75	1,8	6,0
252-8553-000	15S/15, 16S/16	AWG 22/24	1,6	0,9	2,65	1,7	6,0
252-8554-000	15S/15, 16S/16	AWG 20	1,6	1,15	2,65	1,9	6,0
252-8555-000	12, 25	AWG 16, 1,5mm ²	2,4	1,75	3,7	2,75	6,0
252-8556-000	8	6 mm ²	4,4	3,4	6,4	4,8	10,5
252-8557-000	4	AWG 6	7,0	5,65	8,7	7,4	10,5
252-8558-000	0	AWG 2	11,3	9,05	13,1	11,7	14,5
252-8559-000	4	16 mm ²	7,0	6,2	8,7	7,4	10,5
252-8560-000	0	50 mm ²	11,3	10,6	13,1	11,7	14,5
252-8561-000	0	1	11,3	9,9	13,1	11,7	14,5
252-8562-000	500	16 mm ²	10,5	6,2	13,1	8,2	14,5
252-8563-000	100	AWG 12, 2,5 mm ²	4,6	2,4	6,4	4,0	10,5
252-8564-000	500	35 mm ²	10,5	9,2	13,1	11,3	14,5
252-8565-000	500	25 mm ²	10,5	7,6	13,1	9,6	14,5

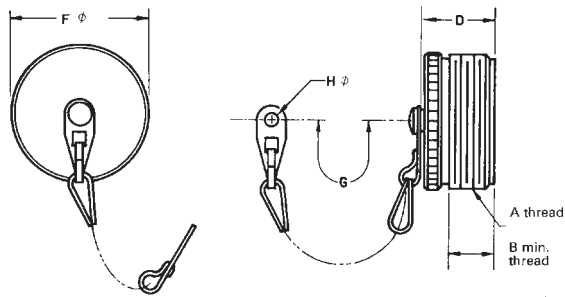

**MS25042
CA17530
CA19741**

Metal protective caps

These externally threaded caps are used to protect 3106 and 3108 plugs. The material is aluminum alloy. The protective caps are furnished with a sash chain. They are also available with a bead chain or less chain.

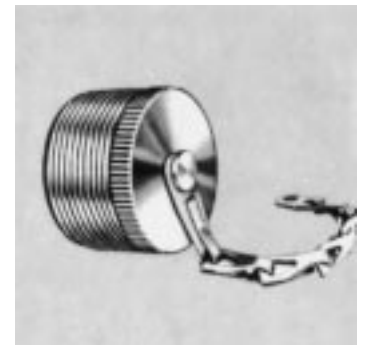

MS Part Number with Sash chain	ITT Cannon Part Number with Sash chain	ITT Cannon Part Number without Sash Chain	Shell Size	A	B min.	H +0,2	F max.	D max.	G max.	Shell Weight with Sash chain gr.	without Sash chain gr.
MS25042-10D	CA17530-5101	CA19741-10	10SL	5/8-24NEF-2A	7,7	3,9	16,7	16,3	107,0	6,4	3,2
MS25042-12D	CA17530-5102	CA19741-12	12S, 12	3/4-20U EF-2A	12,5	3,9	19,8	21,0	120,0	8,7	4,2
MS25042-14D	CA17530-5103	CA19741-14	14S, 14	7/8-20UNEF-2A	12,5	4,9	23,0	21,0	120,0	9,2	5,5
MS25042-16D	CA17530-5104	CA19741-16	16S, 16	1 -20UNEF-2A	12,5	3,9	26,2	21,0	120,0	10,0	6,0
MS25042-18D	CA17530-51005	CA19741-18	18	1-1/8-18NEF-2A	12,5	3,9	21,0	29,4	120,0	13,2	9,2
MS25042-20D	CA17530-5106	CA19741-20	20	1-1/4-18NEF-2A	12,5	4,7	32,5	21,0	124,0	15,5	12,0
MS25042-20D	CA17530.5106	CA19741-20	20	1-1/4-18NEF-2A	12,5	4,7	32,5	21,0	134,0	15,5	12,0
MS25042-22D	CA17530-5107	CA19741-22	22	1-3/8-18NEF-2A	12,5	4,7	35,7	21,0	134,0	16,5	13,3
MS25042-24D	CA17530-5108	CA19741-24	24	1-1/2-18NEF-2A	12,5	4,7	38,9	21,0	147,0	19,2	14,5
MS25042-28D	CA17530-5109	CA19741-28	28	1-3/4-18NS-2A	12,5	4,7	45,2	21,0	207,0	25,5	21,0
MS24042-32S	CA17530-5110	CA19741-32	32	2 -18NS-2A	12,5	5,5	51,6	21,0	207,0	31,0	28,0
MS25042-36D	CA17530-5111	CA19741-36	36	2-1/4-16UN-2A	12,5	5,5	57,9	21,0	207,0	36,05	33,0

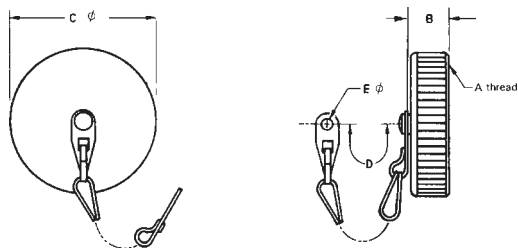

**MS25043
CA2209
CA2322**

Metal protective caps

These internally threaded caps are used to protect 3100, 3101 and 3102 receptacles. The material is aluminum alloy. The protective caps are furnished with or without a sash chain.



MS Part Number with Sash chain	ITT Cannon Part Number with Sash chain	ITT Cannon Part Number without Sash chain	Shell Size	A	B max.	C max.	D max.	E +0,2	Shell Weight with Sash chain gr.	without Sash chain gr.
MS25043-10D	CA2209-5101	CA2322-2	10SL	5/8-24NEF-2B	11,7	20,2	107,0	3,9	5,5	4,1
MS25043-12D	CA2209-5102	CA2322-3	12S, 12	3/4-20UNEF-2B	11,7	23,4	120,0	3,9	7,7	5,0
MS25043-14D	CA2209-5103	CA2322-4	14S, 14	7/8-20UNEF-2B	11,7	26,6	120,0	3,0	8,2	5,5
MS25043-16D	CA2209-5104	CA2322-5	16S, 16	1 -20UNEF-2B	11,7	29,8	120,0	3,9	8,7	6,5
MS25043-18D	CA2209-5105	CA2322-6	18	1-1/8-18NEF-2B	11,7	32,9	120,0	3,9	9,6	7,7
MS25043-20D	CA2209-5106	CA2322-7	20	1-1/4-18NEF-2B	11,7	36,1	134,0	4,7	11,5	9,2
MS25043-22D	CA2209-5107	CA2322-8	22	1-3/8-18NEF-2B	11,7	39,4	134,0	4,7	12,7	10,5
MS25043-24D	CA2209-5108	CA2322-9	24	1-1/2-18NEF-2B	11,7	42,6	147,0	4,7	14,5	8,2
MS25043-28D	CA2209-5109	CA2322-10	28	1-3/4-18NS-2B	13,3	48,9	207,0	4,7	15,0	13,2
MS25043-32D	CA2209-5110	CA2322-11	32	2 -18NS-2B	13,3	55,3	207,0	5,5	26,5	21,0
MS25043-36D	CA2209-5111	CA2322-12	36	2-1/4-16UN-2B	13,3	61,6	207,0	5,5	33,2	27,5

Accessories



Dummy Receptacle MS3105

The dummy receptacle holds 3106 or 3108 plugs when not in use.

Material: Aluminum alloy, finish is olive drab chromate over cadmium plate.

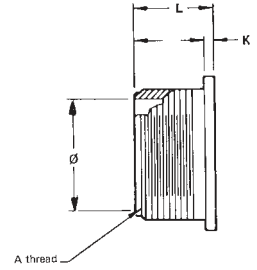
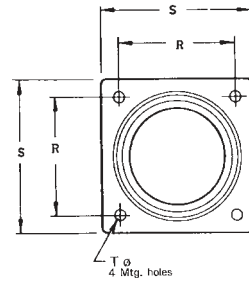

Part Number	Fits	A	K	L	→N	R	S	T	Shell
MS	Shell Size	Thread	max.	max.	max.	±0,1	±0,7	+0,2 -0,1	Weight gr.
MS3105-10S	10SL	5/8-24NEF-2A	2,4	17,2	11,9	18,2	25,4	3,1	5,9
MS3105-12S	12S	3/4-20UNEF-2A	2,4	17,2	14,7	20,6	28,7	3,1	6,4
MS3105-14S	14S	7/8-20UNEF-2A	2,4	17,9	17,9	23,0	30,1	3,1	7,7
MS3105-16S	16S	1 -20UNEF-2A	2,4	17,2	21,0	24,6	32,5	3,1	9,1
MS3105-12	12	3/3-20UNEF-2A	2,4	22,0	14,7	20,6	28,7	3,1	7,3
MS31,05-14	14	7/8-20UNEF	2,4	22,0	17,9	23,0	30,0	3,1	9,1
MS3105-16-	16	1 -20UNEF-2A	2,4	22,0	21,0	24,6	32,5	3,1	10,0
MS3105-18	18	1-1/8-18UNEF-2A	3,0	22,5	24,2	27,0	34,9	3,1	14,1
MS3105-20	20	1-1/4-18UNEF-2A	3,0	22,5	27,4	29,4	38,0	3,1	15,0
MS3105-22	22	1-3/8-18UNEF-2A	3,0	22,5	30,6	31,8	41,3	3,1	16,8
MS3105-24	24	1-1/2-18UNEF-2A	3,0	24,1	33,7	34,9	44,4	3,7	21,8
MS3105-28	28	1-3/4-18UNS-2A	3,0	24,1	39,3	39,7	50,8	3,7	25,4
MS3105-32	32	2 -18UNS-2A	4,3	27,0	45,7	44,5	57,1	4,4	37,2
MS3105-36	36	2-1/4-16UN-2A	4,3	27,0	51,2	49,2	63,4	4,4	44,9

Shell Size	Wire Size		Con- tacts	Part numbers for Crimp Contacts		Part Number for Tools (only for crimp contacts)			
	AWG	metric		metric	AWG	Insertion	Extraction	Crimp	Locators and Dies
10S, 12S 14S, 16S	16S	15S	P	030-8586-000	030-8586-000	CIET-F80-16	CET-F80-16	MS3191-A	600 094
			S	031-8555-000	031-8555-000				600 093
12, 14 16 to 36	16	15	P	030-8587-000	030-8587-000	CIT-F80-16	CET-580-16	MS319,1A	600 092
			S	031-8556-000	031-8556-000				600 091
12, 14 16 to 36	12	25	P	030-8588-000	030-8588-000	CIT-F80-12	CET-F80-12	MS3191A	600 216
			S	031-8557-000	031-8557-000				600 216
16 to 36	8	100	P	030-8590-000	030-8612-000	CIT-8	CET-8		317-8531-000
			S	031-8559-000	031-8519-000				317-8531-001
16 to 36	4	160	P	030-8591-000	030-8613-000	CIT-4	CET-4	Hydraulic tool	317-8532-000
			S	031-8560-000	031-8520-000				317-8532-000
20 to 36	0	500	P	030-8592-000	030-8614-000	CIT-0	CET-0		317-8533-000S
				031-8561-000	030-8521-000				317-8533-001
16 to 36	-	10	P	030-8585-000	-	CIT-F80-20	CET-F80-20	MS3191A	600 219
			S	031-8554-000	-				600 219

P - Pin S - Socket

Crimp Tools

Hydraulic tool

Hand operated, including safety valve
Part no. 4601.00000.330

Hydraulic tool

Foot operated, including safety valve
Part no. 4601.51000.330

Electro-pump

Part no. 46608.00000.020 or 46.00000.840

For additional tools please consult factory.

Accessories for hydraulic tools

Hydraulic crimp head (12 to), part no. 4632.00000.601
to accept the crimp dies mentioned below for contacts AWG 8/100/60/4/160 and 0/500.
High pressure hose, 2 m length, part no. 4604.0000.020.

Crimp dies

For hydraulic tool

Part no.	Contact size	
	AWG	Metric
317-8531-000	8	100/60
317-8531-001		
317-8532-000	4	160
317-8532-001		
317-8533-000	0	500
317-8533-001		

Guide pins

To insert the socket contacts of size 15S/16S, 15/16/25 and 12, the following guiding pins are to be used:

Part no.	Contact size	
	AWG	Metric
226-1017-000	16S/16	15S/15
226-1018-000	12	25

Insertion tools

for contact insertion into the insulator

Contact size	Metric	Part no.
AWG		
-	10	CIT-F80-20
16S/16	15S/15	CIT-F80-16
12	25	CIT-F80-12
8	100	CIT-8
4	160	CIT-4
0	500	CIT-0

Extraction tools

For contact extraction from the insulator

Contact size	Metric	Part no.
AWG		
-	10	CET-F80-16
16S/16	15S/15	CET-F80-16
12	25	CET-F80-12
8	100	CET-8
4	160	CET-4
0	500	CET-0

Wire Hole fillers

Where contacts are not used, the contact cavities are to be closed by wire hole fillers.

Contact size	Wire Size	Part no.	Colour
AWG			
-	20	225-1000-000	red
16S/16	16	225-0017-000	blue
12	12	225-0018-000	yellow
8	8	225-0019-000	white
4	4	225-8502-000	green
0	0	225-8503-000	black

Product Safety Information

THIS NOTE SHOULD BE READ IN CON-JUNCTION WITH THE PRODUCT DATA SHEET/CATALOGUE. FAILURE TO OB-SERVE THE ADVICE IN THIS INFORMATION SHEET AND THE OPERATING CONDITIONS SPECIFIED IN THE PRODUCT DATA SHEET/CATALOGUE COULD RESULT IN HAZAR-DUOUS SITUATIONS.

1. MATERIAL CONTENT AND PHYSICAL FORM

Electrical connectors do not usually contain hazardous materials. They contain conducting and non-conducting materials and can be divided into two groups.

a) Printed circuit types and low cost audio types which employ all plastic insulators and casings.

b) Rugged, Fire Barrier and High Reliability types with metal casings and either natural rubber, synthetic rubber, plastic or glass insulating materials.

Contact materials vary with type of connector and also application and are usually manufactured from either copper, alloys, nickel, alumel, chromel or steel. In special applications, other alloys may be specified.

2. FIRE CHARACTERISTICS AND ELECTRIC SHOCK HAZARD

There is no fire hazard when the connector is correctly wired and used within the specified parameters.

Incorrect wiring or assembly of the connector or careless use of metal tools or conductive fluids, or transit damage to any of the component parts may cause electric shock or burns. Live circuits must be broken by separating mated connectors as this may cause arcing, ionisation and burning.

Heat dissipation is greater at maximum resistance in a circuit. Hot spots may occur when resistance is raised locally by damage, e.g. cracked or deformed contacts, broken strands of wire. Local overheating may also result from the use of the incorrect application tools or from poor quality soldering or slack screw terminals. Overheating may occur if the ratings in the Product Data Sheet/ Catalogue are exceeded and can cause breakdown of insulation and hence electric shock.

If heating is allowed to continue it intensifies by further increasing the local resistance through loss of temper of spring contacts, formation of oxide film on contacts and wires, and leakage currents through carbonisation of insulation and tracking paths. Fire can then result in the presence of combustible materials and this may release noxious fumes. Overheating may not be visually apparent. Burns may result from touching overheated components.

3. HANDLING

Care must be taken to avoid damage to any component parts of electrical connectors during installation and use. Although there are normally no sharp edges, care must be taken when handling certain components to avoid injury to fingers.

Electrical connectors may be damaged in transit to the customers, and damage may result in creation of hazards. Products should therefore be examined prior to installation/use and rejected if found to be damaged.

4. DISPOSAL

Incineration of certain materials may release noxious or even oxid fumes.

5. APPLICATION

Connectors with exposed contacts should not be selected for use on the current supply side of an electrical circuit, because an electric shock could result from touching exposed contacts on an unmated connector. Voltages in excess of 30 V ac or 42.5 V dc are potentially hazardous and care should be taken to ensure that such voltages can not be transmitted in any way to exposed metal parts of the connector body. The connector and wiring should be checked, before making live, to have no damage to metal parts of insulators, no solder blobs, loose strands, conducting lubricants, swarf, or any other undersired conducting particles. Insulation resistance should be checked to make certain that no low resistance joints or spurious conducting path are existing between contacts and exposed metal parts of the connector body. Further the contact resistance of the connectors should be measured within the electrical circuit in order to identify high resistances which result in excessive connector heating.

Always use the correct application tools as specified in the Data Sheet/Catalogue.

Do not permit untrained personnel to wire, assemble or tramper with connectors.

For operation voltage please see appropriate national regulations

IMPORTANT GENERAL INFORMATION.

1. Air and creepage paths/Operating voltage

The admissible operating voltages depend on the individual applications and the valid national and other applicable safety regulations.

For this reason the air and creepage path data are only reference values. Observe reduction of air and creepage paths due to PC board and/or harnessing.

2. Temperature

All information given are temperature limits. The operation temperature depends on the individual application.

3. Other important information

Cannon continuously endeavours to improve their products. Therefore, Cannon products may deviate from the description, technical data and shape as shown in this catalogue and data sheets.

4. Harnessing and Assembly Instructions

If applicable, our special harnessing and/or assembly instruction has to be adhered to. This is provided at request.

ITT Cannon manufactures the highest quality products available in the marketplace; however these products are intended to be used in accordance with the specifications in this catalog. Any use or application that deviates from stated operating specifications is not recommended and may be unsafe. No information and data contained in this catalog shall be construed to create any liability on the part of ITT Cannon. Any new issue of this catalog shall automatically invalidate and supersede any and all previous issues. **A limited warranty applies to ITT Cannon products. Except for obligations assumed by ITT Cannon under this warranty, ITT Cannon shall not be liable for any loss, damage, cost of repairs, incidental or consequential damages of any kind, whether or not based on express or implied warranty, contract, negligence or strict liability arising in connection with the design, manufacture, sale, use or repair of the products.** Product availability, prices and delivery dates are exclusively subject to our respective order confirmation form; the same applies to orders based on development samples delivered. This catalog is not be construed as an offer. It is intended merely as an invitation to make an offer. By this publication, ITT Cannon does not assume responsibility or any liability for any patent infringements or other rights of third parties which may result from its use. Reprinting this catalog is generally permitted, indicating the source. However, ITT Cannon's prior consent must be obtained in all cases.

Cannon is a trademark of ITT Industries, Inc