

Printed-circuit board connector - FKICS 2,5/ 6-STD-5,08-RN - 1808763

Please be informed that the data shown in this PDF Document is generated from our Online Catalog. Please find the complete data in the user's documentation. Our General Terms of Use for Downloads are valid (<http://download.phoenixcontact.com>)

Plug component, Nominal current: 12 A, Rated voltage (III/2): 320 V, Number of positions: 6, Pitch: 5.08 mm, Connection method: Spring-cage conn., Color: green, Contact surface: Tin



Key commercial data

Packing unit	0
Minimum order quantity	1
GTIN	 4 046356 701556
Custom tariff number	85366990
Country of origin	GERMANY

Technical data

Dimensions / positions

Length	26.5 mm
Height	15 mm
Pitch	5.08 mm
Dimension a	25.4 mm
Number of positions	6

Technical data

Range of articles	FKICS 2,5/...-STD-RN
Insulating material group	I
Rated surge voltage (III/3)	4 kV
Rated surge voltage (III/2)	4 kV
Rated surge voltage (II/2)	4 kV
Rated voltage (III/2)	320 V
Rated voltage (II/2)	630 V
Connection in acc. with standard	EN-VDE
Nominal current I_N	12 A
Nominal voltage U_N	320 V

Printed-circuit board connector - FKICS 2,5/ 6-STD-5,08-RN - 1808763

Technical data

Technical data

Nominal cross section	2.5 mm ²
Maximum load current	12 A
Insulating material	PA
Inflammability class according to UL 94	V0
Internal cylindrical gage	A2
Stripping length	10 mm
Nominal voltage, UL/CUL Use Group B	300 V
Nominal current, UL/CUL Use Group B	10 A
Nominal voltage, UL/CUL Use Group D	300 V
Nominal current, UL/CUL Use Group D	10 A

Connection data

Conductor cross section solid min.	0.2 mm ²
Conductor cross section solid max.	2.5 mm ²
Conductor cross section stranded min.	0.2 mm ²
Conductor cross section stranded max.	2.5 mm ²
Conductor cross section stranded, with ferrule without plastic sleeve min.	0.25 mm ²
Conductor cross section stranded, with ferrule without plastic sleeve max.	2.5 mm ²
Conductor cross section stranded, with ferrule with plastic sleeve min.	0.25 mm ²
Conductor cross section stranded, with ferrule with plastic sleeve max.	2.5 mm ²
Conductor cross section AWG/kcmil min.	24
Conductor cross section AWG/kcmil max	12
2 conductors with same cross section, stranded, TWIN ferrules with plastic sleeve, min.	0.5 mm ²
2 conductors with same cross section, stranded, TWIN ferrules with plastic sleeve, max.	1 mm ²
Minimum AWG according to UL/CUL	26
Maximum AWG according to UL/CUL	12

Classifications

ETIM

ETIM 3.0	EC001121
ETIM 4.0	EC002638
ETIM 5.0	EC002638

UNSPSC

UNSPSC 11	39121409
UNSPSC 12.01	39121409
UNSPSC 13.2	39121409

Printed-circuit board connector - FKICS 2,5/ 6-STD-5,08-RN - 1808763

Classifications

UNSPSC

UNSPSC 6.01	30211810
UNSPSC 7.0901	39121409

eCl@ss

eCl@ss 4.0	272607xx
eCl@ss 4.1	27260701
eCl@ss 5.0	27260701
eCl@ss 5.1	27141190
eCl@ss 6.0	27260704
eCl@ss 7.0	27440402

Approvals

Approvals

Approvals

UL Recognized / cUL Recognized / cULus Recognized

Ex Approvals

Approvals submitted

Approval details

UL Recognized 		
	B	D
mm ² /AWG/kcmil	26-12	26-12
Nominal current I _N	10 A	10 A
Nominal voltage U _N	300 V	300 V

cUL Recognized 		
	B	D
mm ² /AWG/kcmil	26-12	26-12
Nominal current I _N	10 A	10 A
Nominal voltage U _N	300 V	300 V

Printed-circuit board connector - FKICS 2,5/ 6-STD-5,08-RN - 1808763

Approvals

cULus Recognized 

Accessories

Accessories

Assembly

Strain relief - STZ 4-FKC-5,08 - 1876877



Strain relief for snapping into the latching chambers of the plugs, 4-pos.

Strain relief - STZ 8-FKC-5,08 - 1876880

Strain relief for snapping into the latching chambers of the plug components, 8-pos.

Marking

Marker cards - SK 5,08/3,8:FORTL.ZAHLEN - 0804293



Marker cards, Card, white, labeled, Horizontal: Consecutive numbers 1 - 10, 11 - 20, etc. up to 91 - (99)100, Mounting type: Adhesive, For terminal block width: 5.08 mm

Plug/Adapter

Keying star - CR-MSTB - 1734401



Coding section, inserted into the recess in the header or the inverted plug, red insulating material

Printed-circuit board connector - FKICS 2,5/ 6-STD-5,08-RN - 1808763

Accessories

Reducing plug - RPS - 0201647



Reducing plug, Color: gray

Test plugs - MPS-MT - 0201744



Test plugs

Tools

Screwdriver - SZS 0,6X3,5 - 1205053



Actuation tool, for ST terminal blocks, insulated, also suitable for use as a bladed screwdriver, size: 0.6 x 3.5 x 100 mm, 2-component grip, with non-slip grip

Drawings

Diagram

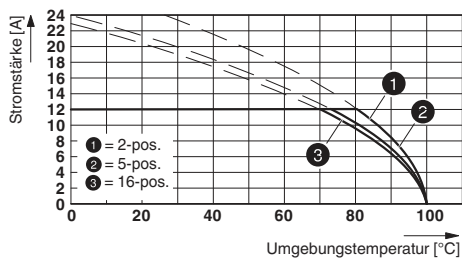

Type: FKIC 2,5/...-ST-5,08-RF with FKICS 2,5/...-STD-5,08-RN

Printed-circuit board connector - FKICS 2,5/ 6-STD-5,08- RN - 1808763

Dimensioned drawing

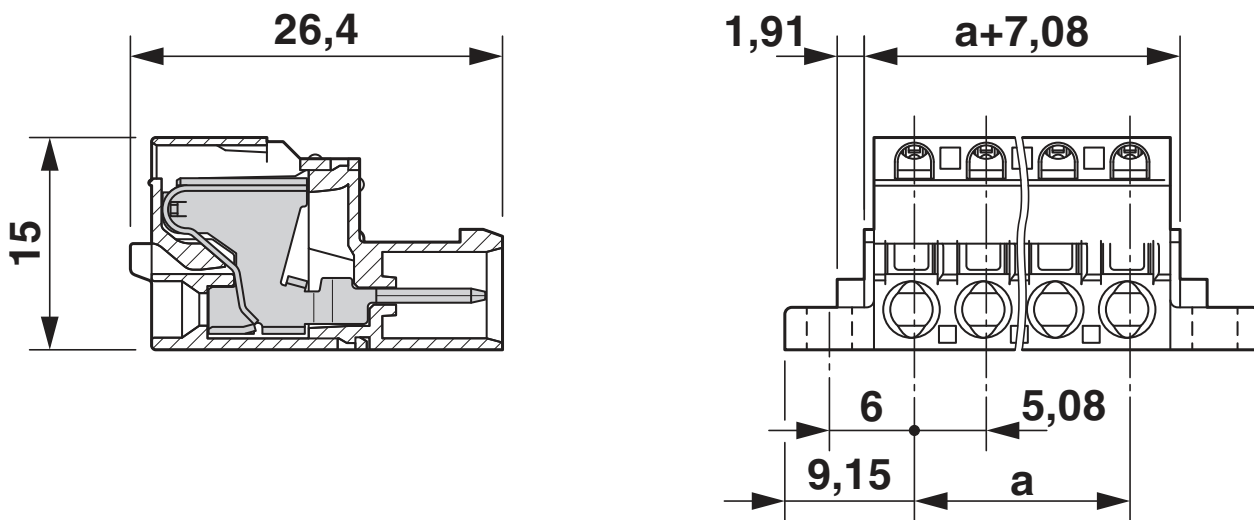



© Phoenix Contact 2012 - all rights reserved
<http://www.phoenixcontact.com>