

STRADA-SQ-FS

Forward throw beam for area lighting. Version with location pins. Assembly with installation tape.

SPECIFICATION:

Dimensions	25.0 x 25.0 mm
Height	12.6 mm
Fastening	tape, pin
ROHS compliant	yes ⓘ



MATERIALS:

Component	Type	Material	Colour	Finish
STRADA-SQ-FS	Single lens	PMMA	clear	
ROSE-TAPE	Tape	Acrylic foam	black	

ORDERING INFORMATION:

Component	Type	Qty in box	MOQ	MPQ	Box weight (kg)
CA13897_STRADA-SQ-FS » Box size: 480 x 280 x 300 mm	Single lens	1568	294	98	6.5

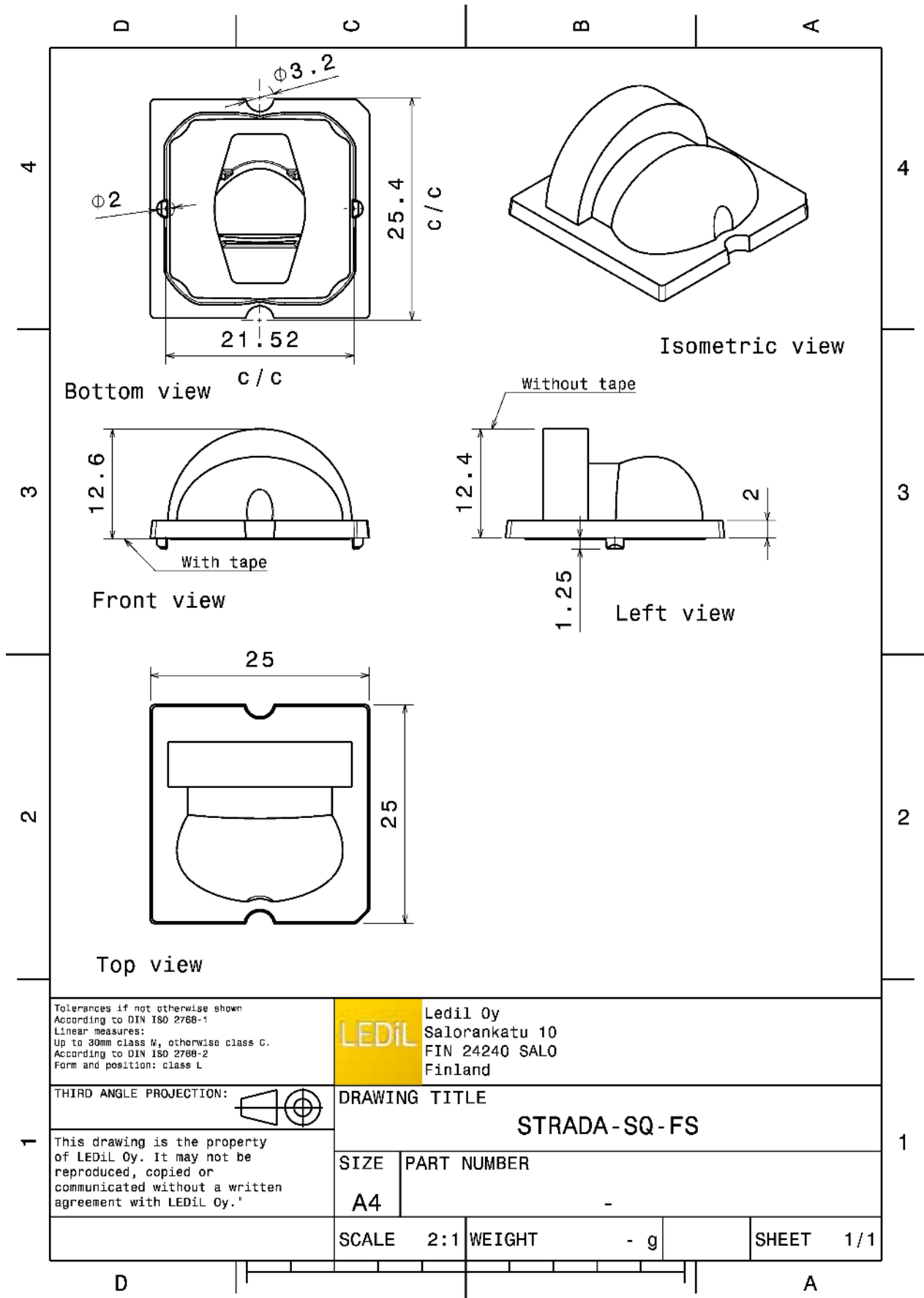

Tolerances if not otherwise shown
According to DIN ISO 2768-1
Linear measures:
Up to 30mm class M, otherwise class C.
According to DIN ISO 2768-2
Form and position: class L

LEDiL Ledil Oy
Salorankatu 10
FIN 24240 SALO
Finland

THIRD ANGLE PROJECTION:

DRAWING TITLE
STRADA-SQ-FS

This drawing is the property of LEDiL Oy. It may not be reproduced, copied or communicated without a written agreement with LEDiL Oy.

SIZE	PART NUMBER
A4	-

SCALE	2:1	WEIGHT	- g	SHEET	1/1
-------	-----	--------	-----	-------	-----

See also our general installation guide: www.ledil.com/installation_guide

OPTICAL RESULTS (MEASURED):

CREE → LED

LED MK-R
 FWHM / FWTM Asymmetric
 Efficiency 93 %
 Peak intensity 0.9 cd/lm
 LEDs/each optic 1
 Light colour White
 Required components:

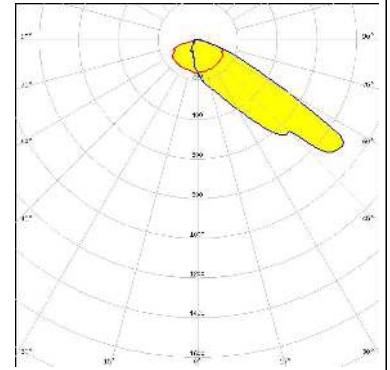

CREE → LED

LED XHP35 HI
 FWHM / FWTM Asymmetric
 Efficiency 93 %
 Peak intensity 1.2 cd/lm
 LEDs/each optic 1
 Light colour White
 Required components:

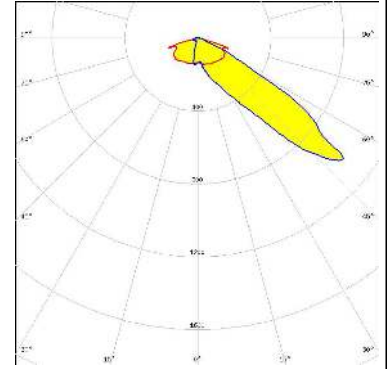

CREE → LED

LED XHP50
 FWHM / FWTM Asymmetric
 Efficiency 93 %
 Peak intensity 0.9 cd/lm
 LEDs/each optic 1
 Light colour White
 Required components:

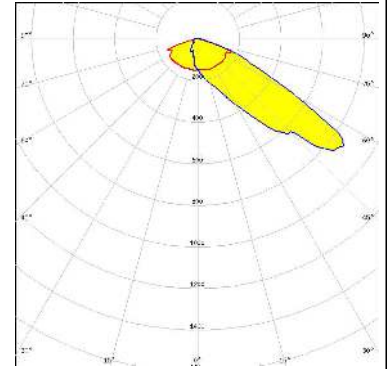





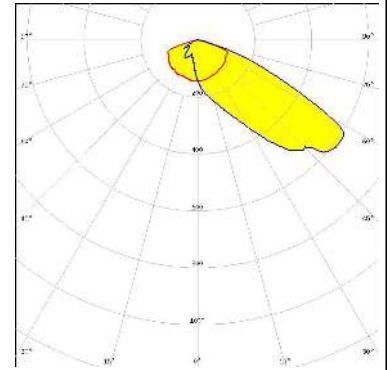

CREE → LED

LED XHP70
 FWHM / FWTM Asymmetric
 Efficiency 80 %
 Peak intensity 0.6 cd/lm
 LEDs/each optic 1
 Light colour White
 Required components:

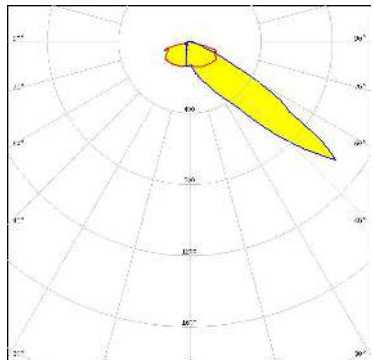
Protective plate, glass

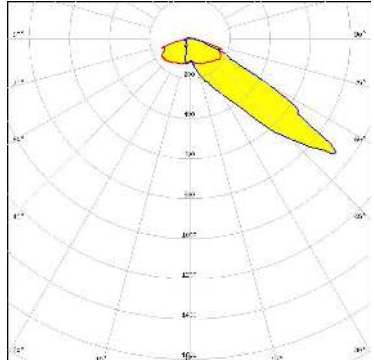

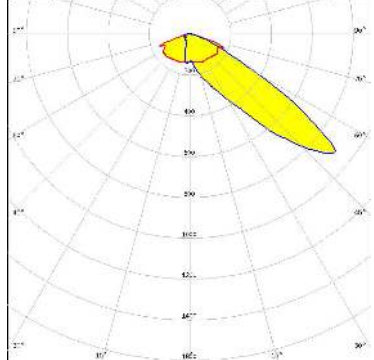
OPTICAL RESULTS (MEASURED):

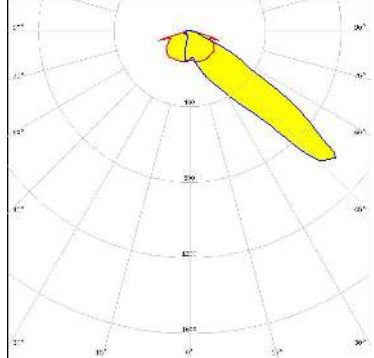
<p>CREE  LED</p> <p>LED XM-L FWHM / FWTM Asymmetric Efficiency 93 % Peak intensity 1.2 cd/lm LEDs/each optic 1 Light colour White Required components:</p>	
<p>CREE  LED</p> <p>LED XP-L HD FWHM / FWTM Asymmetric Efficiency 93 % Peak intensity 1.1 cd/lm LEDs/each optic 1 Light colour White Required components:</p>	
<p>CREE  LED</p> <p>LED XP-L2 FWHM / FWTM Asymmetric Efficiency 93 % Peak intensity 1 cd/lm LEDs/each optic 1 Light colour White Required components:</p>	
<p>CREE  LED</p> <p>LED XT-E FWHM / FWTM Asymmetric Efficiency 93 % Peak intensity 1.2 cd/lm LEDs/each optic 1 Light colour White Required components:</p>	



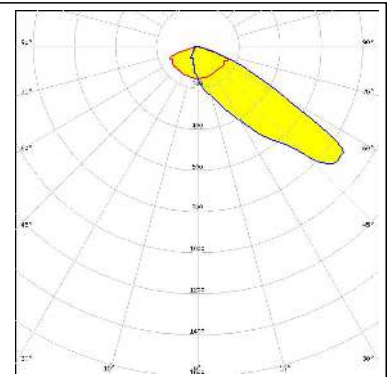
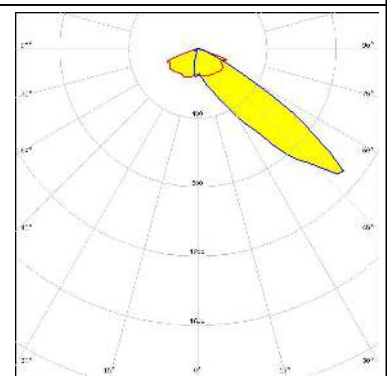
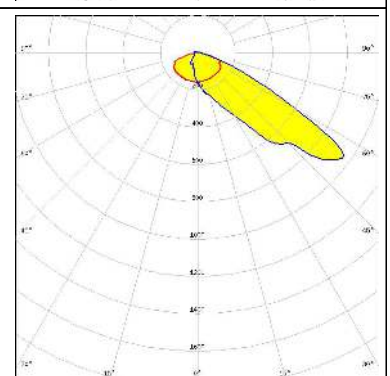
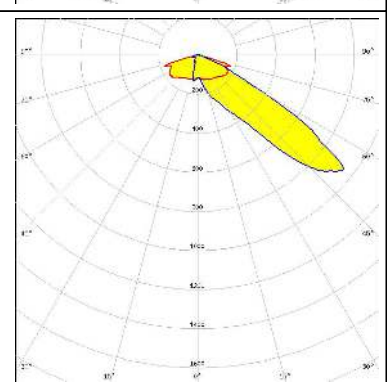

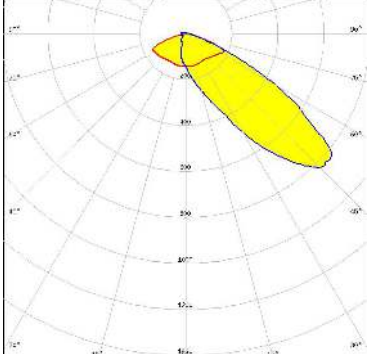
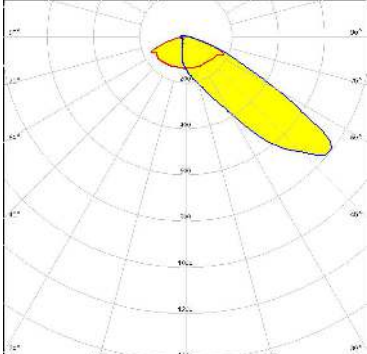

OPTICAL RESULTS (MEASURED):

<p>LUMILEDS</p> <p>LED LUXEON M/MX</p> <p>FWHM / FWTM Asymmetric</p> <p>Efficiency 92 %</p> <p>Peak intensity 0.9 cd/lm</p> <p>LEDs/each optic 1</p> <p>Light colour White</p> <p>Required components:</p>	
<p>LUMILEDS</p> <p>LED LUXEON MZ</p> <p>FWHM / FWTM Asymmetric</p> <p>Efficiency 94 %</p> <p>Peak intensity 1.2 cd/lm</p> <p>LEDs/each optic 1</p> <p>Light colour White</p> <p>Required components:</p>	
<p>LUMILEDS</p> <p>LED LUXEON XR-M Linear (L2M0-xxxx003MC3300)</p> <p>FWHM / FWTM Asymmetric</p> <p>Efficiency 94 %</p> <p>Peak intensity 1 cd/lm</p> <p>LEDs/each optic 1</p> <p>Light colour White</p> <p>Required components:</p>	
<p>NICHIA</p> <p>LED NVSW319B</p> <p>FWHM / FWTM Asymmetric</p> <p>Efficiency 94 %</p> <p>Peak intensity 1.2 cd/lm</p> <p>LEDs/each optic 1</p> <p>Light colour White</p> <p>Required components:</p>	

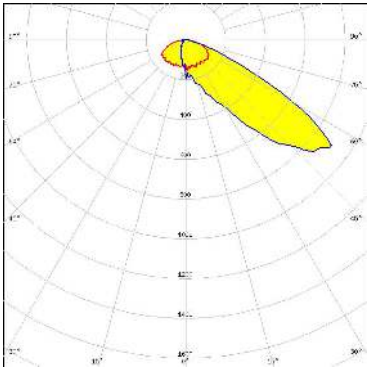
OPTICAL RESULTS (MEASURED):

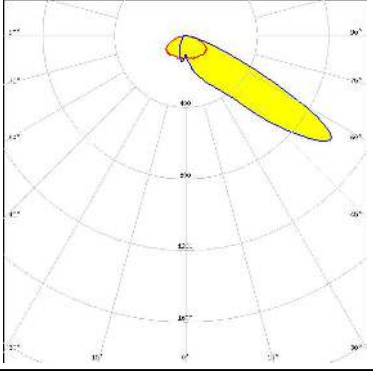
<p>OSRAM Opto Semiconductors</p> <p>LED Duris S10</p> <p>FWHM / FWTM Asymmetric</p> <p>Efficiency 91 %</p> <p>Peak intensity 0.9 cd/lm</p> <p>LEDs/each optic 1</p> <p>Light colour White</p> <p>Required components:</p>	
<p>SEOUL SEMICONDUCTOR</p> <p>LED Z8Y50P</p> <p>FWHM / FWTM Asymmetric</p> <p>Efficiency 89 %</p> <p>Peak intensity 0.8 cd/lm</p> <p>LEDs/each optic 1</p> <p>Light colour White</p> <p>Required components:</p>	

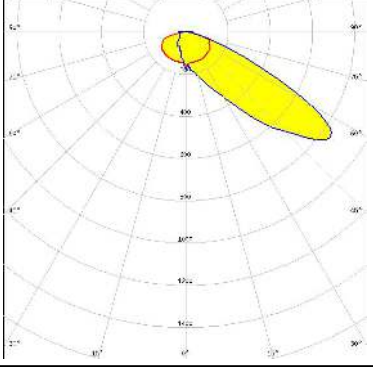
OPTICAL RESULTS (SIMULATED):

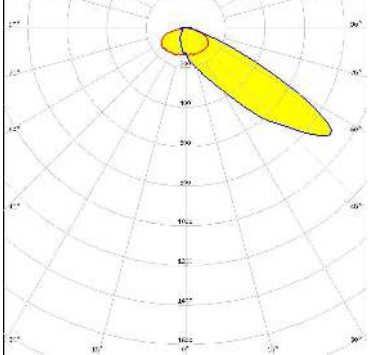
	<p>LED: MHB-A/B FWHM / FWTM: Asymmetric Efficiency: % LEDs/each optic: 1 Light colour: White Required components:</p>	
	<p>LED: XHP35 HD FWHM / FWTM: Asymmetric Efficiency: 92 % Peak intensity: 1 cd/lm LEDs/each optic: 1 Light colour: White Required components:</p>	
	<p>LED: XHP50.2 FWHM / FWTM: 71.0 + 30.0° / 133.0 + 92.0° Efficiency: 93 % Peak intensity: 0.9 cd/lm LEDs/each optic: 1 Light colour: White Required components:</p>	
	<p>LED: XHP50.3 HD FWHM / FWTM: Asymmetric Efficiency: 91 % Peak intensity: 0.9 cd/lm LEDs/each optic: 1 Light colour: White Required components:</p>	

OPTICAL RESULTS (SIMULATED):

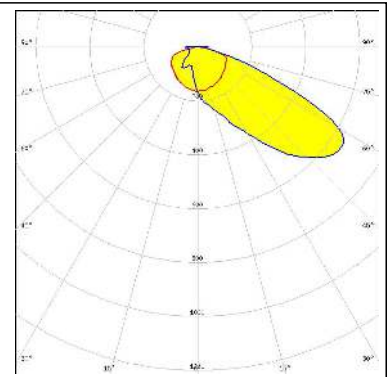
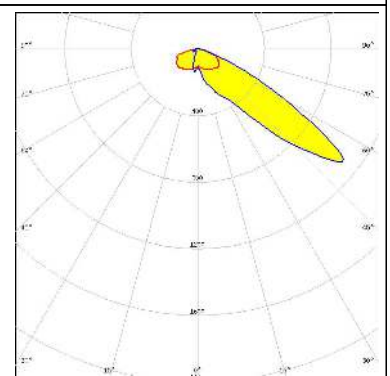
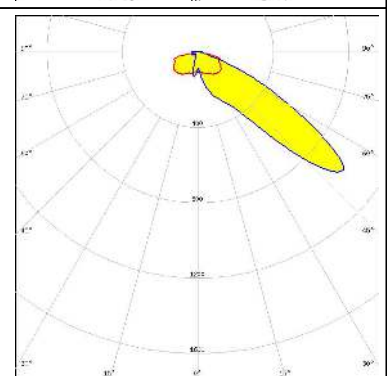
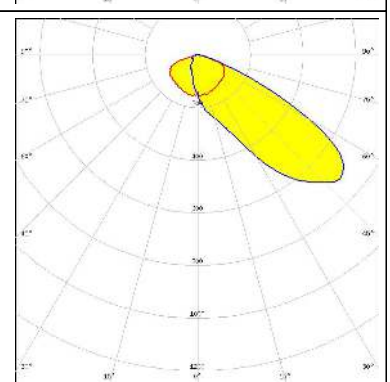
<p>CREE → LED</p> <p>LED: XHP70.2 FWHM / FWTM: Asymmetric Efficiency: 91 % Peak intensity: 0.7 cd/lm LEDs/each optic: 1 Light colour: White Required components:</p>	
<p>CREE → LED</p> <p>LED: XM-L2 FWHM / FWTM: Asymmetric Efficiency: 93 % Peak intensity: 1.1 cd/lm LEDs/each optic: 1 Light colour: White Required components:</p>	
<p>CREE → LED</p> <p>LED: XP-G3 FWHM / FWTM: Asymmetric Efficiency: 93 % Peak intensity: 1 cd/lm LEDs/each optic: 1 Light colour: White Required components:</p>	
<p>LUMILEDS</p> <p>LED: LUXEON 7070 FWHM / FWTM: Asymmetric Efficiency: 82 % Peak intensity: 0.7 cd/lm LEDs/each optic: 1 Light colour: White Required components:</p> <p>Protective plate, glass</p>	

OPTICAL RESULTS (SIMULATED):

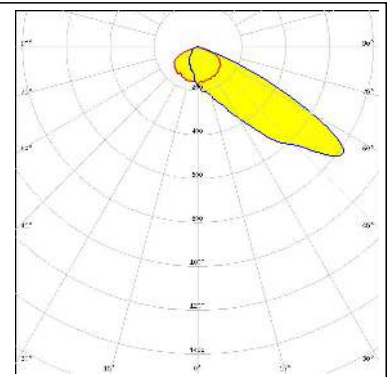
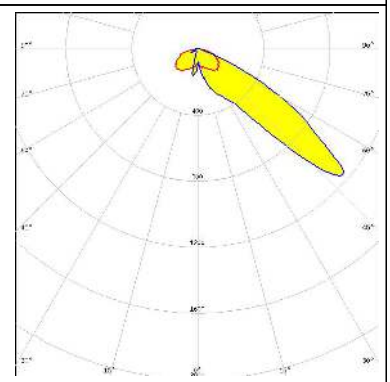
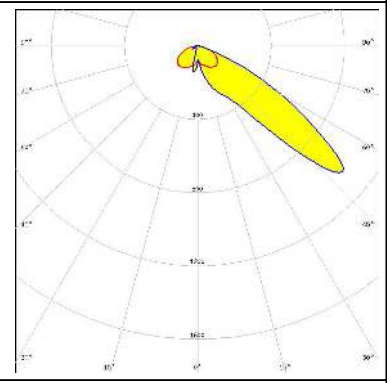
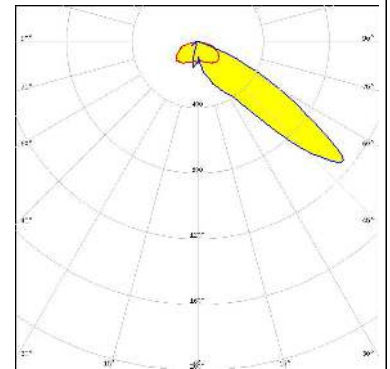
<p>LUMILEDS</p> <p>LED: LUXEON M/MX FWHM / FWTM: Asymmetric Efficiency: 81 % Peak intensity: 0.8 cd/lm LEDs/each optic: 1 Light colour: White Required components:</p> <p>Protective plate, glass</p>	
<p>LUMINUS</p> <p>LED: SFT-40-WCS FWHM / FWTM: Asymmetric Efficiency: 94 % Peak intensity: 1.3 cd/lm LEDs/each optic: 1 Light colour: White Required components:</p>	
<p>LUMINUS</p> <p>LED: SFT-40-WCS FWHM / FWTM: Asymmetric Efficiency: 81 % Peak intensity: 1.1 cd/lm LEDs/each optic: 1 Light colour: White Required components:</p> <p>Protective plate, glass</p>	
<p>LUMINUS</p> <p>LED: SFT-70X-WCS FWHM / FWTM: Asymmetric Efficiency: 94 % Peak intensity: 1.2 cd/lm LEDs/each optic: 1 Light colour: White Required components:</p>	

OPTICAL RESULTS (SIMULATED):

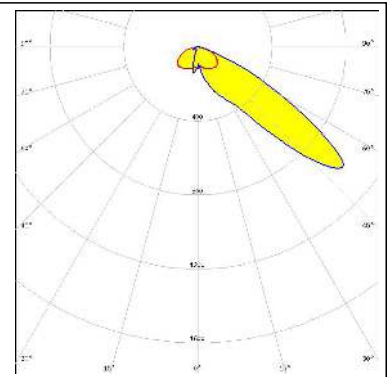
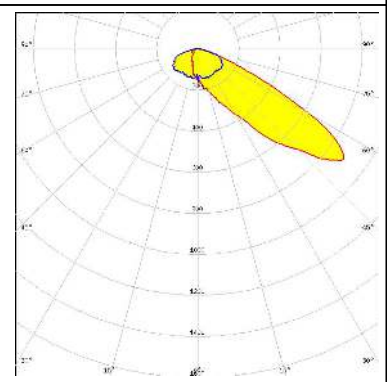
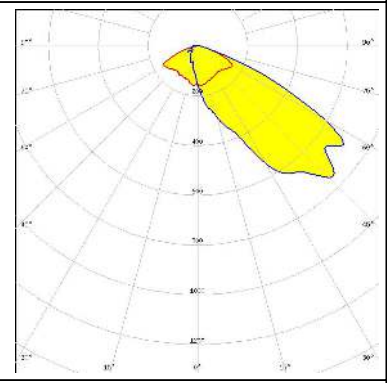
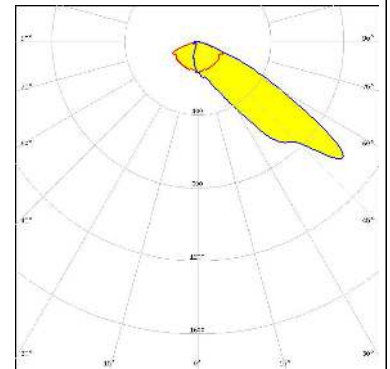
<p>LUMINUS</p> <p>LED SFT-70X-WCS FWHM / FWTM Asymmetric Efficiency 81 % Peak intensity 1 cd/lm LEDs/each optic 1 Light colour White Required components:</p> <p>Protective plate, glass</p>	
<p>NICHIA</p> <p>LED NV4x144A FWHM / FWTM Asymmetric Efficiency 92 % Peak intensity 0.9 cd/lm LEDs/each optic 1 Light colour White Required components:</p>	
<p>NICHIA</p> <p>LED NVSxE21A FWHM / FWTM Asymmetric Efficiency 92 % Peak intensity 0.8 cd/lm LEDs/each optic 9 Light colour White Required components:</p>	
<p>NICHIA</p> <p>LED NVSxE21A FWHM / FWTM Asymmetric Efficiency 91 % Peak intensity 1 cd/lm LEDs/each optic 4 Light colour White Required components:</p>	

OPTICAL RESULTS (SIMULATED):

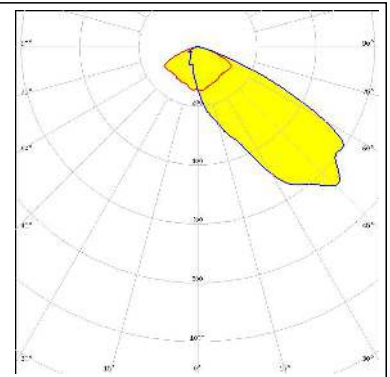
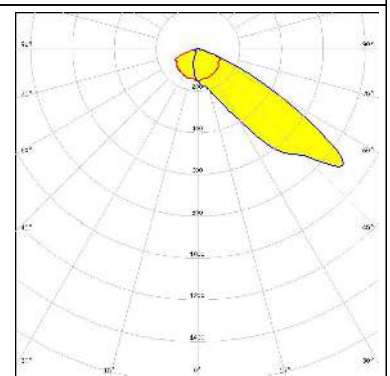
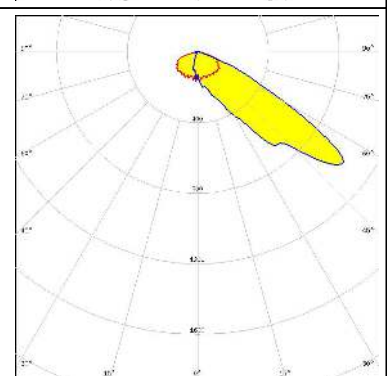
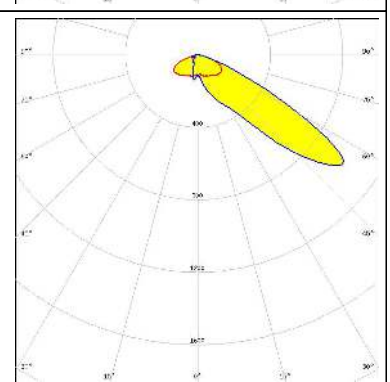
<p>NICHIA</p> <p>LED: NVSxE21A FWHM / FWTM: Asymmetric Efficiency: 80 % Peak intensity: 0.7 cd/lm LEDs/each optic: 9 Light colour: White Required components:</p> <p>Protective plate, glass</p>	
<p>NICHIA</p> <p>LED: NVSxE21A FWHM / FWTM: Asymmetric Efficiency: 79 % Peak intensity: 0.9 cd/lm LEDs/each optic: 4 Light colour: White Required components:</p> <p>Protective plate, glass</p>	
<p>OSRAM <small>Opto Semiconductors</small></p> <p>LED: OSCONIQ P 7070 FWHM / FWTM: Asymmetric Efficiency: 90 % Peak intensity: 1 cd/lm LEDs/each optic: 1 Light colour: White Required components:</p>	
<p>SAMSUNG</p> <p>LED: LH351D FWHM / FWTM: Asymmetric Efficiency: 93 % Peak intensity: 1.1 cd/lm LEDs/each optic: 1 Light colour: White Required components:</p>	

GENERAL INFORMATION:

NOTE: The typical beam angle will be changed by different color, chip size and chip position tolerance. The typical total beam angle is the full angle measured where the luminous intensity is half of the peak value.

MATERIALS:

As part of our continuous research and improvement processes, and to ensure the best possible quality and availability of our products, LEDiL reserves the right to change material grades without notice.

PRODUCT DATA USER AGREEMENT AND DISCLAIMER:

The measured data in the provided downloadable LEDiL Product Datasheets and Mechanical 2D-Drawings is rounded and provided as reference for planning. LEDiL Oy's optical specifications have been verified by conducting performance testing of the products in accordance with the company's quality system. The reported data are averaged results of multiple measurements with typical variation. LEDiL Oy reserves the right to without prior notification make changes and improvements to its products.

LEDiL Oy assumes neither warranty, nor guarantee nor any other liability of any kind for the contents and correctness of the provided data. The provided data has been generated with highest diligence but the provided data may in reality not represent the complete possible variation range of all intrinsic parameters. Therefore, in certain cases a deviation from the provided data could occur.

LEDiL Oy reserves the right to undertake technical changes of its products without further notification which could lead to changes in the provided data. LEDiL Oy assumes no liability of any kind for the possible deviation from any provided data or any other damage resulting from the usage of the provided data.

The user agrees to this disclaimer and user agreement with the download or usage of the provided files.

LEDiL Oy

Joensuunkatu 13
FI-24240 SALO
Finland

LEDiL Inc.

228 West Page Street
Suite D
Sycamore IL 60178
USA

Ledil Optics Technology (Shenzhen) Co., Ltd.

405 , Block B
Casic Motor Building
Shenzhen 518057
P.R.CHINA

Local sales and technical support

[www.ledil.com/
where_to_buy](http://www.ledil.com/where_to_buy)

Shipping locations

Salo, Finland
Hong Kong, China

Distribution Partners

[www.ledil.com/
where_to_buy](http://www.ledil.com/where_to_buy)