

DO NOT SCALE FROM THIS PRINT

FTS-1XX-XX-XX-XX-XX

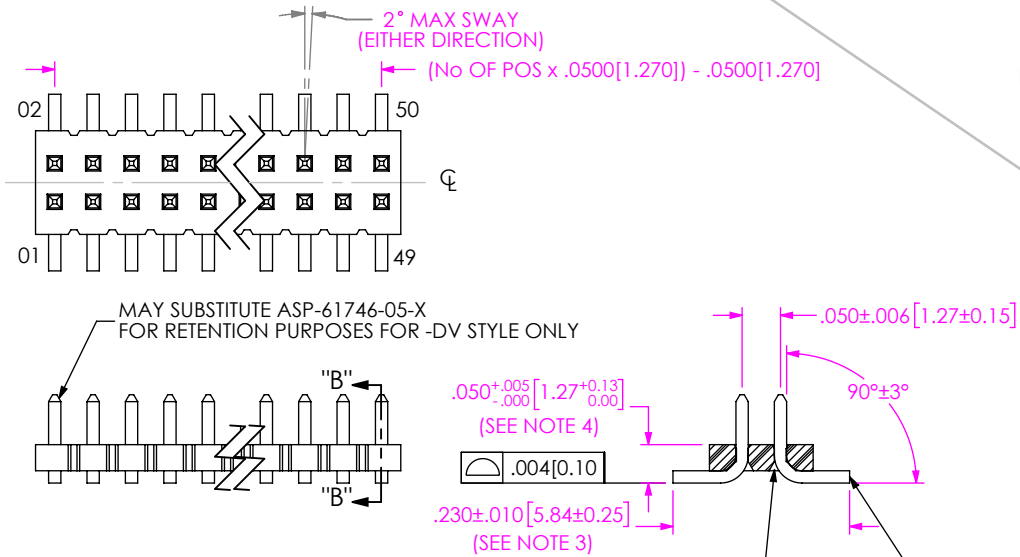
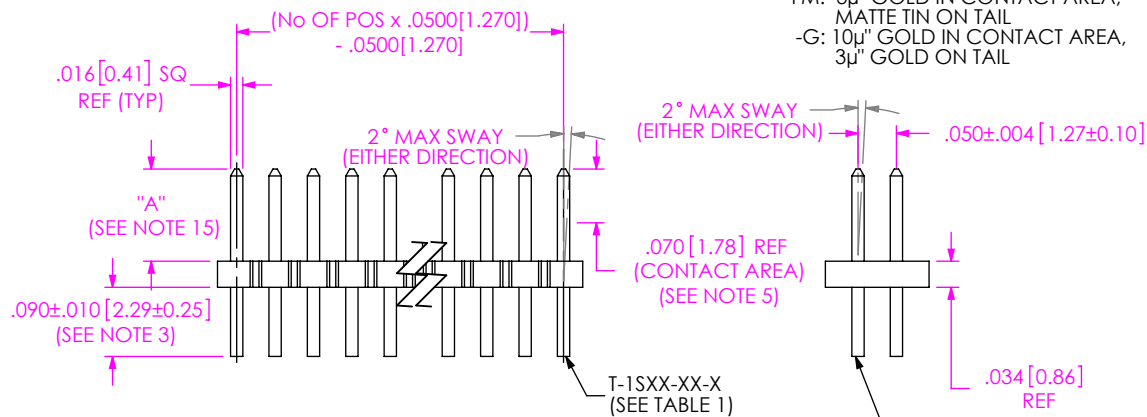
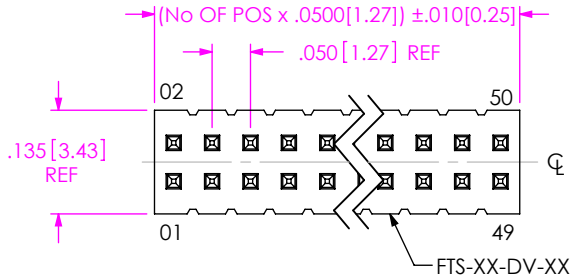

No OF POSITIONS  
 -02 THRU -50 (UNSHROUDED)  
 -05 THRU -46 (SHROUDED)

LEAD STYLE  
 SEE TABLE 1

PLATING SPECIFICATION

- L: 10µ" GOLD IN CONTACT AREA, MATTE TIN ON TAIL
- F: 3µ" GOLD IN CONTACT AREA, MATTE TIN ON TAIL
- S: 30µ" GOLD IN CONTACT AREA, MATTE TIN ON TAIL
- H: 30µ" GOLD IN CONTACT AREA, 3µ" GOLD ON TAIL
- SM: 30µ" GOLD IN CONTACT AREA, MATTE TIN ON TAIL
- LM: 10µ" GOLD IN CONTACT AREA, MATTE TIN ON TAIL
- FM: 3µ" GOLD IN CONTACT AREA, MATTE TIN ON TAIL
- G: 10µ" GOLD IN CONTACT AREA, 3µ" GOLD ON TAIL

- OPTIONS
- P: PICK AND PLACE PAD (USE PPP-25) (AVAILABLE ON POSITIONS 04 THRU 50) (SEE FIG 5, SHT 2 & FIG 7, SHT 3) (USE PPP-25-NT FOR TAPE & REEL)
  - TR: TAPE & REEL PACKAGING (SEE FIG 10, SHT 4) (SEE NOTE 16) (ONLY AVAILABLE WITH -DV OPTION)
  - S: END SHROUDS (SEE FIG 3, SHT 2 & FIG 6 SHT 3) (LEAD STYLE -02 & -03 ONLY) (05 POS MINIMUM, 46 POS MAXIMUM) (NOT AVAILABLE WITH -A OPTION; ORDER -SA FOR ALIGNMENT PIN WITH SHROUD)
  - SA: END SHROUDS W/ ALIGNMENT PINS (SEE FIG 4, SHT 2 & FIG 8, SHT 3) (LEAD STYLE -02 & -03 ONLY) (05 POS MINIMUM, 46 POS MAXIMUM) (SEE NOTES 6 & 7)
  - A: MOLDED ALIGNMENT PIN (USE FTS-XX-DV-XX) (ONLY AVAILABLE IN -DV OPTION, 5 POS MINIMUM) (SEE FIG 9, SHT 3) (NOT AVAILABLE WITH -S OPTION; ORDER -SA FOR ALIGNMENT PIN AND SHROUD)
  - FR: FULL REEL QTY. TAPE & REEL (SEE NOTE 17)
- TAIL OPTION
- D: DOUBLE ROW THROUGH HOLE
  - DV: DOUBLE ROW VERTICAL SURFACE MOUNT

TABLE 1			
LEAD STYLE	"A"	HAND FILL	BKT MACHINE
-01	0.120 [3.05]	T-1S40-04-XX-2	T-1S15-03-XXX
-02	0.075 [1.91]	T-1S15-03-XXX	T-1S15-03-XXX
-03	0.065 [1.65]	T-1S15-06-XXX	T-1S15-03-XXX
-04	0.150 [3.81]	T-1S15-03-XXX	T-1S15-03-XXX

- NOTES:
1. REPRESENTS A CRITICAL DIMENSION.
  2. PARTS MAY BE CUT TO POSITION.
  3. SHEAR TAILS TO DIMENSION RADIUS SHOWN.
  4. MEASURED AT BEND RADIUS, NOT AT END OF PIN.
  5. GOLD PLATING TO BE ON POST, TIN PLATING TO BE ON TAIL.
  6. 4 POSITIONS PER ROW WILL BE COVERED BY SHROUDS. (2 POSITIONS PER ROW ON EACH END).
  7. 4 POSITIONS MUST BE ADDED TO PART CALLOUT TO ALLOW FOR SHROUDS, EXAMPLE FTS-125-02-L-D-SA REQUIRES A 29 POSITION BODY.
  8. NOTE DELETED.
  9. MINIMUM PUSHOUT FORCE: .5 LB (8 OZ)
  10. MAXIMUM CUT FLASH: .015[0.38]
  11. PPP-25-NT MUST BE USED FOR ALL TAPE AND REEL PACKAGING.
  12. FILL BODY SO THAT THE LEAD IN OF THE CORE IS ON THE TAILS SIDE FOR -DV OPTION ONLY.
  13. MAXIMUM BURR ALLOWANCE: .003[0.08]
  14. FOR PACKAGING OPTION LEFT BLANK. POSITIONS -05 THRU -50 TO BE TUBED. POSITIONS -02 THRU -04 ON TAIL OPTION -D TO BE LAYER PACKAGED. POSITIONS -02 THRU -04 ON TAIL OPTION -DV TO BE TAPE AND REELED.
  15. MAX HEIGHT VARIATION BETWEEN ROWS: .005[0.13].
  16. -TR OPTION ORDERS INVOLVING PARTIAL REEL QUANTITIES MAY BE PACKAGED ACCORDING TO THE SAMTEC PACKAGING EFFICIENCY STANDARDS (SPES) FOUND ON WWW.SAMTEC.COM.
  17. -FR OPTIONS WILL BE SHIPPED AT THE MAX QUANTITY PER REEL, BASED ON OPTIONS SELECTED.

FIG 1  
 FTS-1XX-01-XX-D SHOWN

FIG 2  
 FTS-1XX-03-XX-DV SHOWN

UNLESS OTHERWISE SPECIFIED, DIMENSIONS ARE IN INCHES. TOLERANCES ARE:  
 DECIMALS ANGLES  
 .XX: ±.01 [.3] 2°  
 .XXX: ±.005 [.13]  
 .XXXX: ±.0020 [.051]

PROPRIETARY NOTE  
 THIS DOCUMENT CONTAINS CONFIDENTIAL AND PROPRIETARY INFORMATION AND ALL DESIGN, MANUFACTURING, REPRODUCTION, USE, PATENT RIGHTS AND SALES RIGHTS ARE EXPRESSLY RESERVED BY SAMTEC, INC. THIS DOCUMENT SHALL NOT BE DISCLOSED, IN WHOLE OR PART, TO ANY UNAUTHORIZED PERSON OR ENTITY NOR REPRODUCED, TRANSFERRED OR INCORPORATED IN ANY OTHER PROJECT IN ANY MANNER WITHOUT THE EXPRESS WRITTEN CONSENT OF SAMTEC, INC.



520 PARK EAST BLVD, NEW ALBANY, IN 47150  
 PHONE: 812-944-6733 FAX: 812-948-5047  
 e-Mail info@SAMTEC.com code 55322

MATERIAL: DO NOT SCALE DRAWING SHEET SCALE: 4:1  
 INSULATOR: LCP, UL 94 V0, COLOR: BLACK  
 TERMINAL: PHOS BRONZE

DESCRIPTION: .050 X .050 C.L. LOW PROFILE TERMINAL STRIP ASSEMBLY

DWG. NO. FTS-1XX-XX-XX-XX-XX

BY: BRATCHER 11/29/1993 SHEET 1 OF 4

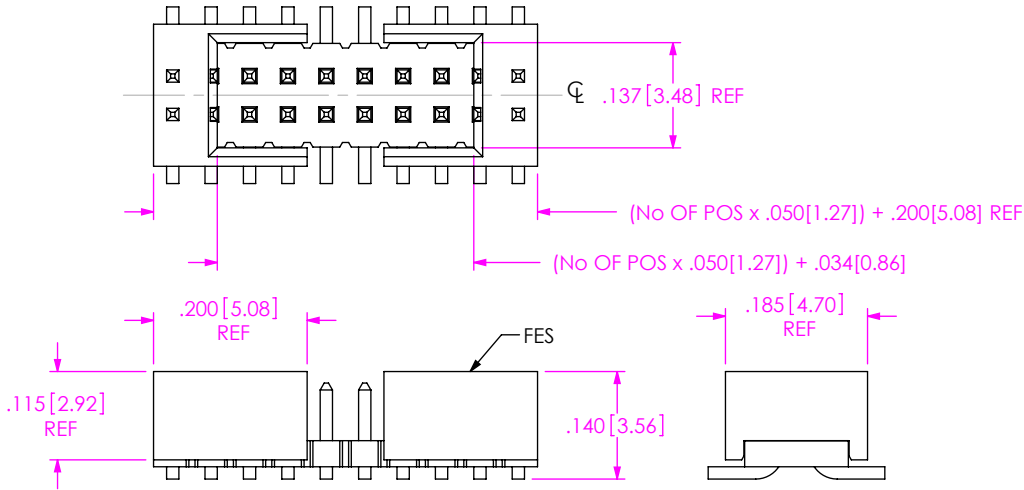

**FIG 3**  
 -DV-S OPTION (SEE NOTES 6 & 7)  
 FTS-106-02-XX-DV-S SHOWN  
 (DIFFERENT AS SHOWN, OTHERWISE SAME AS FIG 1)  
 NOTE: 4 POSITIONS MUST BE ADDED TO PART CALLOUT TO ACHIEVE DIMS  
 (NOT AVAILABLE WITH -A OPTION; ORDER -SA FOR ALIGNMENT PIN WITH SHROUD)

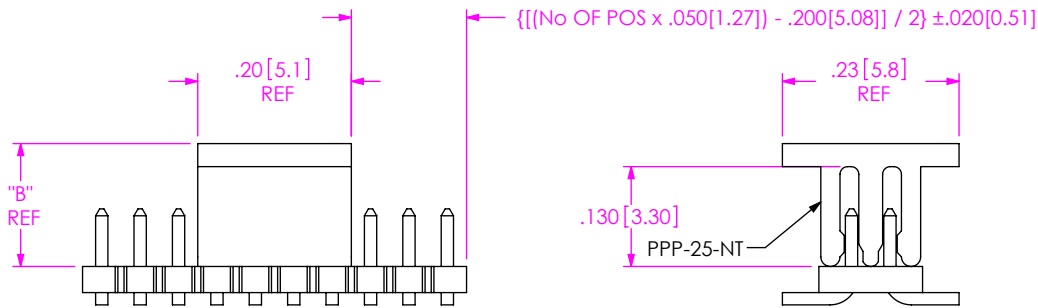

(USE PPP-25-NT FOR TAPE AND REEL PACKAGING ONLY)

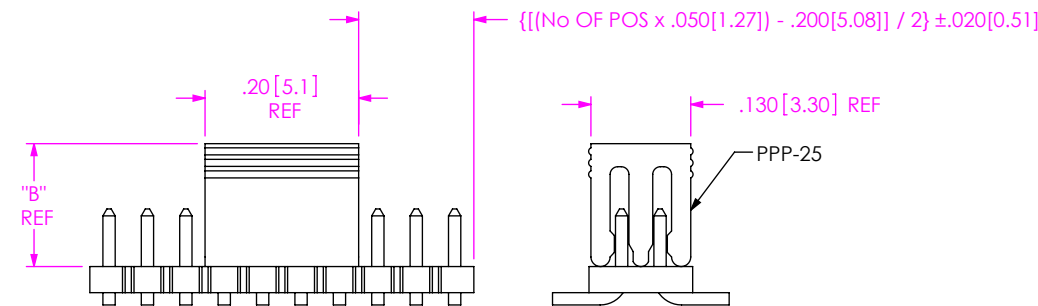

**FIG 5**  
 -DV-P OPTION  
 FTS-110-02-XX-DV-P SHOWN  
 (DIFFERENT AS SHOWN, OTHERWISE SAME AS FIG 1)

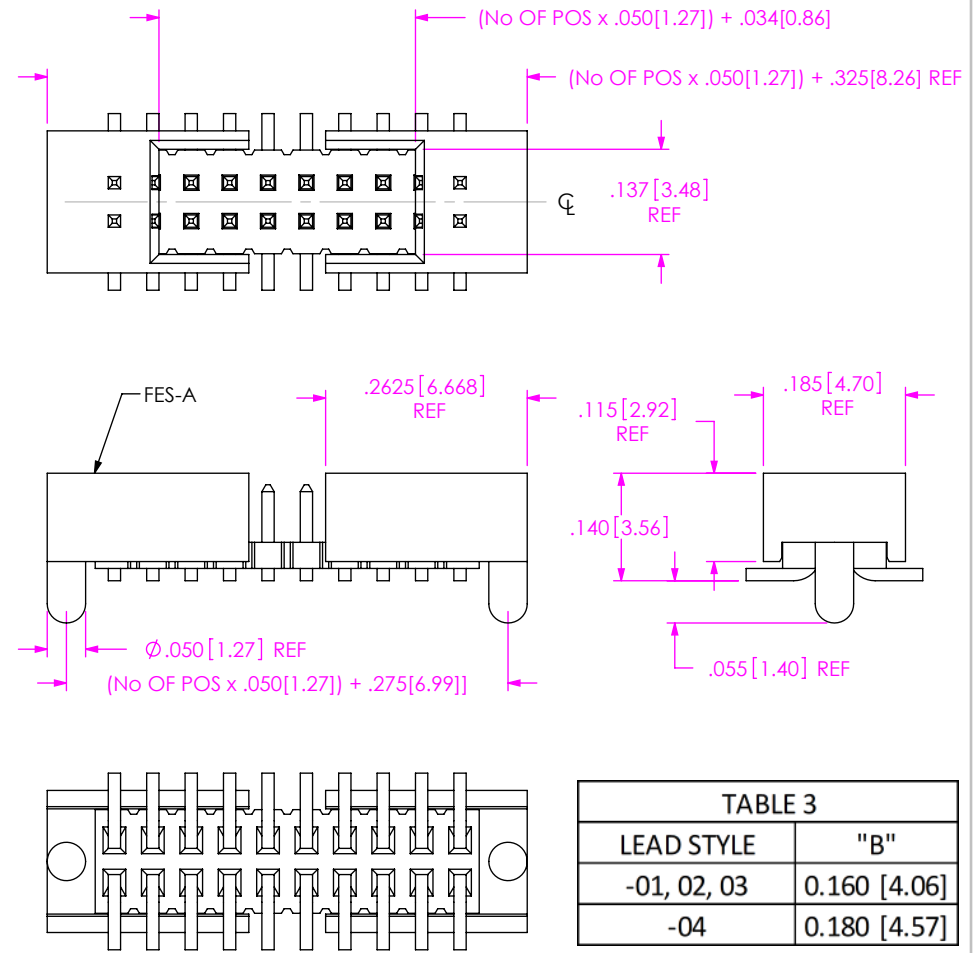

TABLE 3	
LEAD STYLE	"B"
-01, 02, 03	0.160 [4.06]
-04	0.180 [4.57]

**FIG 4**  
 -DV-SA OPTION (SEE NOTES 6 & 7)  
 FTS-106-02-XX-DV-SA SHOWN  
 (DIFFERENT AS SHOWN, OTHERWISE SAME AS FIG 1)  
 NOTE: 4 POSITIONS MUST BE ADDED TO PART CALLOUT TO ACHIEVE DIMS

F:\DWG\MISC\MKTG\FTS-1XX-XX-XX-XX-MKT.SLDDRW

**PROPRIETARY NOTE**

THIS DOCUMENT CONTAINS CONFIDENTIAL AND PROPRIETARY INFORMATION AND ALL DESIGN, MANUFACTURING, REPRODUCTION, USE, PATENT RIGHTS AND SALES RIGHTS ARE EXPRESSLY RESERVED BY SAMTEC, INC. THIS DOCUMENT SHALL NOT BE DISCLOSED, IN WHOLE OR PART, TO ANY UNAUTHORIZED PERSON OR ENTITY NOR REPRODUCED, TRANSFERRED OR INCORPORATED IN ANY OTHER PROJECT IN ANY MANNER WITHOUT THE EXPRESS WRITTEN CONSENT OF SAMTEC, INC.

DO NOT SCALE DRAWING

SHEET SCALE: 4:1



520 PARK EAST BLVD, NEW ALBANY, IN 47150  
 PHONE: 812-944-6733 FAX: 812-948-5047  
 e-Mail info@SAMTEC.com code 55322

DESCRIPTION: .050 X .050 C.L. LOW PROFILE  
 TERMINAL STRIP ASSEMBLY

DWG. NO. **FTS-1XX-XX-XX-XX-XX**

BY: BRATCHER 11/29/1993 SHEET 2 OF 4

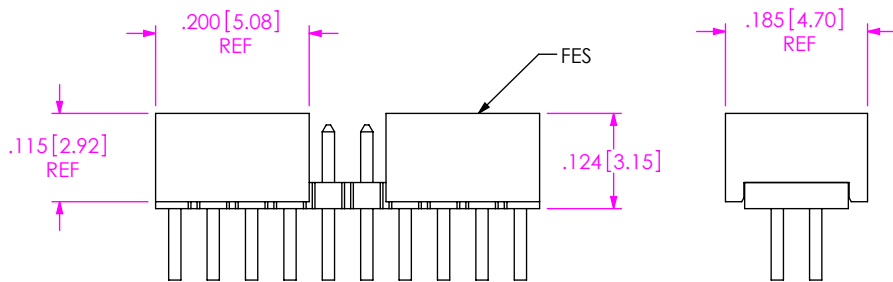
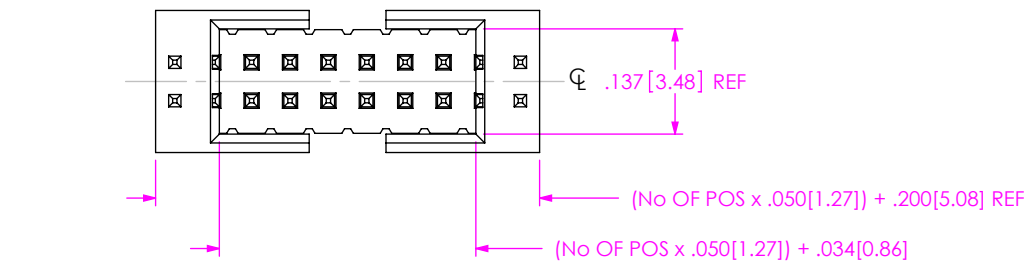

FIG 6  
-D-S OPTION (SEE NOTES 6 & 7)  
FTS-106-02-XX-D-S SHOWN  
(DIFFERENT AS SHOWN, OTHERWISE SAME AS FIG 1)  
NOTE: 4 POSITIONS MUST BE ADDED TO PART CALLOUT TO ACHIEVE DIMS  
(NOT AVAILABLE WITH -A OPTION; ORDER -SA FOR ALIGNMENT PIN WITH SHROUD)

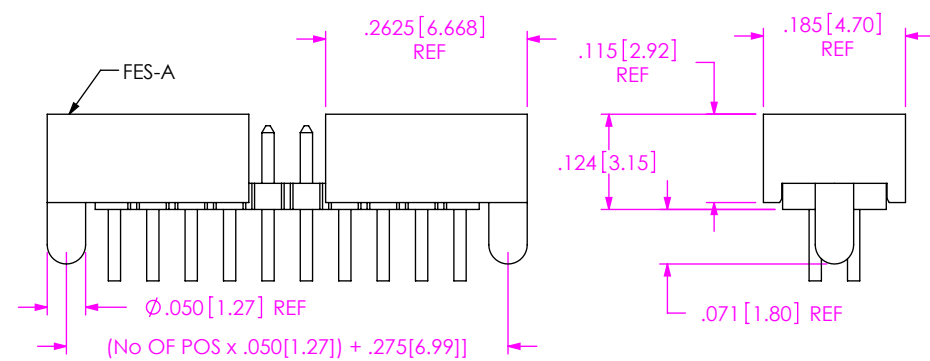
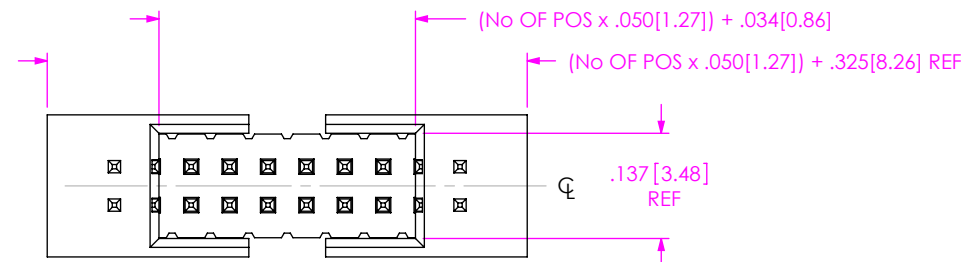

FIG 8  
-D-SA OPTION (SEE NOTES 6 & 7)  
FTS-106-02-XX-D-SA SHOWN  
(DIFFERENT AS SHOWN, OTHERWISE SAME AS FIG 1)  
NOTE: 4 POSITIONS MUST BE ADDED TO PART CALLOUT TO ACHIEVE DIMS

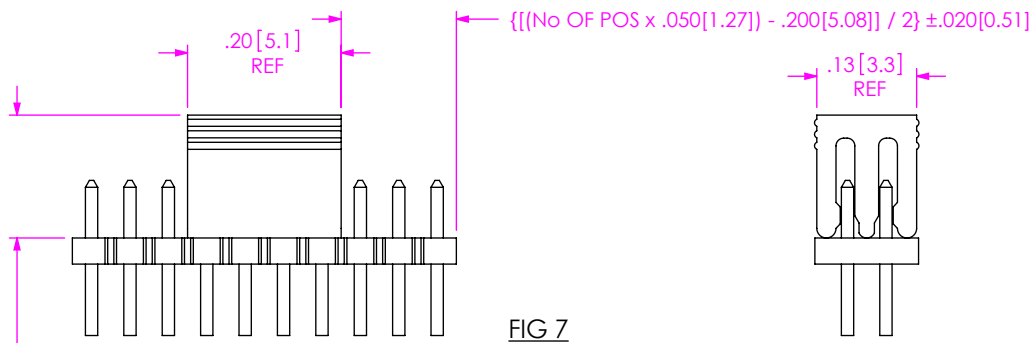

FIG 7  
-D-P OPTION  
FTS-110-02-XX-D-P SHOWN  
(DIFFERENT AS SHOWN, OTHERWISE SAME AS FIG 1)  
"B" REF (SEE TABLE 3, SHT 2)

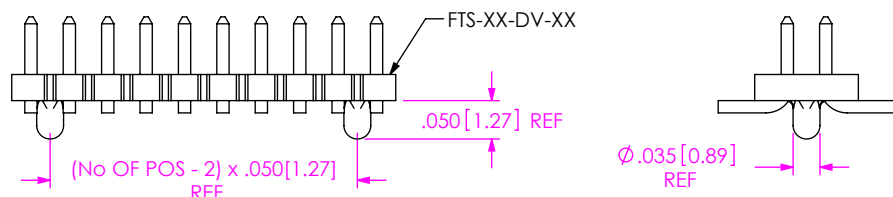

FIG 9  
-A MOLDED ALIGNMENT PIN  
FTS-110-02-XX-DV-A SHOWN  
(ONLY AVAILABLE IN -DV OPTION)  
(DIFFERENT AS SHOWN, OTHERWISE SAME AS FIG 1)

PROPRIETARY NOTE  
THIS DOCUMENT CONTAINS CONFIDENTIAL AND PROPRIETARY INFORMATION AND ALL DESIGN, MANUFACTURING, REPRODUCTION, USE, PATENT RIGHTS AND SALES RIGHTS ARE EXPRESSLY RESERVED BY SAMTEC, INC. THIS DOCUMENT SHALL NOT BE DISCLOSED, IN WHOLE OR PART, TO ANY UNAUTHORIZED PERSON OR ENTITY NOR REPRODUCED, TRANSFERRED OR INCORPORATED IN ANY OTHER PROJECT IN ANY MANNER WITHOUT THE EXPRESS WRITTEN CONSENT OF SAMTEC, INC.

DO NOT SCALE DRAWING

SHEET SCALE: 4:1

F:\DWG\MISC\MKTG\FTS-1XX-XX-XX-XX-MKT.SLDDRW

520 PARK EAST BLVD, NEW ALBANY, IN 47150  
PHONE: 812-944-6733 FAX: 812-948-5047  
e-Mail info@SAMTEC.com code 55322

DESCRIPTION: .050 X .050 C.L. LOW PROFILE TERMINAL STRIP ASSEMBLY

DWG. NO. FTS-1XX-XX-XX-XX-XX

BY: BRATCHER 11/29/1993 SHEET 3 OF 4

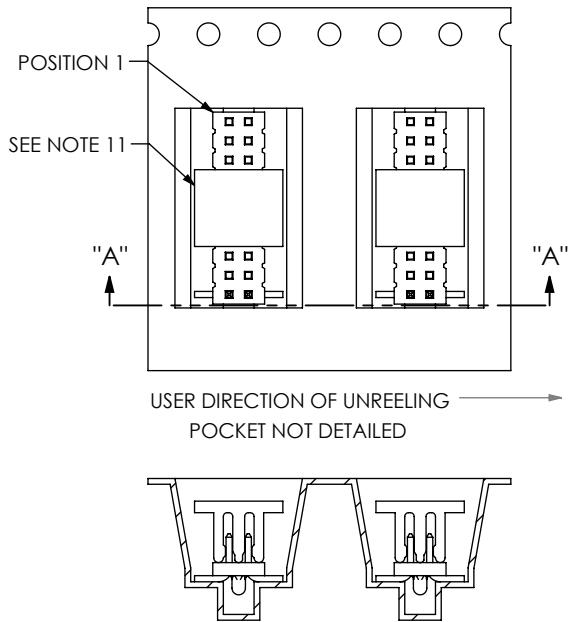

SECTION "A"- "A"

FIG 10

-TR: TAPE AND REEL PACKAGING WITH PPP-25-NT PAD  
NOT AVAILABLE ON THROUGH HOLE LEAD STYLES

TABLE 2		
LEAD STYLE	PACKAGING TUBE	PLUG
-01/02/03/04-D	PT-FW001-D-.070-.198	TP-24
-DV, -D-P, -DV-P, -DV-A	PT-1-24-01-43	TP-24
-D-S(A)-P	PT-1-24-11-09	TP-24
-DV-S(A)-P	PT-1-24-01-09	TP-24
-D-S(A)	PT-1-24-01-37	TP-24-02
DV-S(A)	PT-1-24-02-36	TP-24-02

SEE NOTE 14

TUBE PACKAGING VIEW

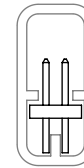

-01-D, -02-D, -03-D

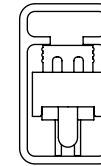

-D-S(A)-P

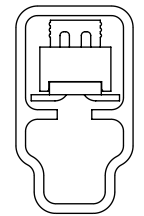

-DV-S(A)-P

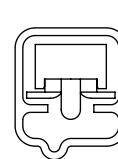

-DV-S(A)

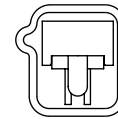

-D-S(A)

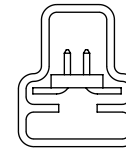

-DV

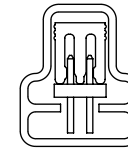

-D-P

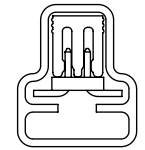

-DV-P

IN PROCESS VIEWS

(HANDFILL ONLY)

NOTE: -02 & -03 LEAD STYLES WITH -A PINS; BKT MACHINE ONLY

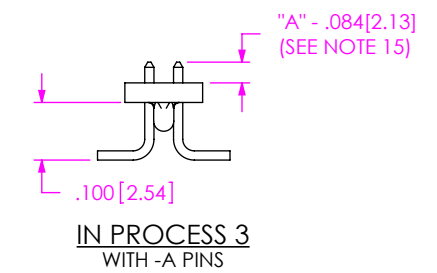
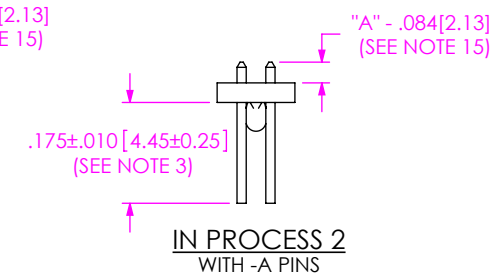
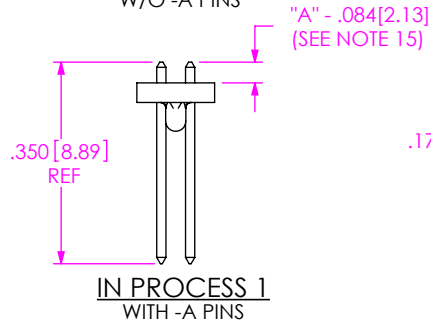
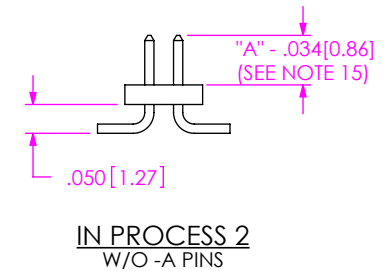
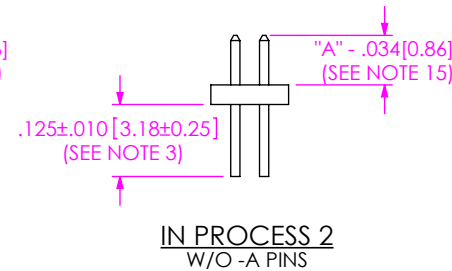
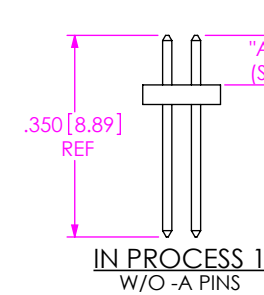

PROPRIETARY NOTE

THIS DOCUMENT CONTAINS CONFIDENTIAL AND PROPRIETARY INFORMATION AND ALL DESIGN, MANUFACTURING, REPRODUCTION, USE, PATENT RIGHTS AND SALES RIGHTS ARE EXPRESSLY RESERVED BY SAMTEC, INC. THIS DOCUMENT SHALL NOT BE DISCLOSED, IN WHOLE OR PART, TO ANY UNAUTHORIZED PERSON OR ENTITY NOR REPRODUCED, TRANSFERRED OR INCORPORATED IN ANY OTHER PROJECT IN ANY MANNER WITHOUT THE EXPRESS WRITTEN CONSENT OF SAMTEC, INC.

DO NOT SCALE DRAWING

SHEET SCALE: 2:1



520 PARK EAST BLVD. NEW ALBANY, IN 47150  
PHONE: 812-944-6733 FAX: 812-948-5047  
e-Mail info@SAMTEC.com code 55322

DESCRIPTION: .050 X .050 C.L. LOW PROFILE  
TERMINAL STRIP ASSEMBLY

DWG. NO. FTS-1XX-XX-XX-XX-XX

BY: BRATCHER 11/29/1993 SHEET 4 OF 4