

ABBREVIATION	DESCRIPTION	COLOR	MATERIAL
A-BLACK	HOUSING, KEYING OPTION A	BLACK	SPS/NYLON GF20
B-LIGHT GRAY	HOUSING, KEYING OPTION B	LIGHT GRAY	SPS/NYLON GF20
C-BROWN	HOUSING, KEYING OPTION C	BROWN	SPS/NYLON GF20
D-GREEN	HOUSING, KEYING OPTION D	GREEN	SPS/NYLON GF20
C-DARK GRAY	HOUSING, KEYING OPTION C	DARK GRAY	SPS/NYLON GF20
D-STONE GRAY	HOUSING, KEYING OPTION D	STONE GRAY	SPS/NYLON GF20
A-YELLOW	HOUSING, KEYING OPTION A	YELLOW	SPS/NYLON GF20
GC	GROMMET CAP (STANDARD)	BLACK	SPS/NYLON GF20
GCL	GROMMET CAP (LENGTHENED)	BLACK	SPS/NYLON GF20
PLR	PLR	NATURAL	SPS/NYLON GF20
M	MAT SEAL	ROYAL BLUE	INHERENTLY LUBRICATED SILICONE

FOR ADDITIONAL INFORMATION SEE SD-33482-0001

ASSEMBLY DESCRIPTION	ASSEMBLY PART NUMBER	COMPONENT				BLOCKED TERMINALS			STATUS	COMMENT	OPTIONAL ATTACHMENTS SOLD SEPARATELY	
		THE PRESENCE OF AN ABBREVIATION INDICATES THE PRESENCE OF THAT COMPONENT				CAVITY WITH A NUMBER INDICATES BLOCKED TERMINAL POSITION CAVITY WITHOUT A NUMBER INDICATES OPEN TERMINAL POSITION					BACKSHELL WITH RIBS	BACKSHELL WITHOUT RIBS
		HOUSING KEY/COLOR	GROMMET CAP	PLR	MAT SEAL							
MX150 ASSY BLD 2X3 BK A/6	334823601	A-BLACK	GC	PLR	M	-	-	-	SALEABLE		34950-0610	34950-0620
MX150 ASSY BLD 2X3 LG B/6	334823602	B-LIGHT GRAY	GC	PLR	M	-	-	-	SALEABLE		34950-0610	34950-0620
MX150 ASSY BLD 2X3 BR C/6	334823603	C-BROWN	GC	PLR	M	-	-	-	NOT RECOMMENDED	SEE 334823628	34950-0610	34950-0620
MX150 ASSY BLD 2X3 GR D/6	334823604	D-GREEN	GC	PLR	M	-	-	-	NOT RECOMMENDED	SEE 334823629	34950-0610	34950-0620
MX150 ASSY BLD 2X3 BK A/5	334823606	A-BLACK	GC	PLR	M	-	-	3	SALEABLE		34950-0610	34950-0620
MX150 ASSY BLD 2X3 LG B/5	334823607	B-LIGHT GRAY	GC	PLR	M	-	-	3	SALEABLE		34950-0610	34950-0620
MX150 ASSY BLD 2X3 BR C/5	334823608	C-BROWN	GC	PLR	M	-	-	3	NOT RECOMMENDED	SEE 334823638	34950-0610	34950-0620
MX150 ASSY BLD 2X3 GR D/5	334823609	D-GREEN	GC	PLR	M	-	-	3	NOT RECOMMENDED	SEE 334823641	34950-0610	34950-0620
MX150 ASSY BLD 2X3 BK A/4	334823611	A-BLACK	GC	PLR	M	-	-	3	SALEABLE		34950-0610	34950-0620
MX150 ASSY BLD 2X3 LG B/4	334823612	B-LIGHT GRAY	GC	PLR	M	4	-	-	SALEABLE		34950-0610	34950-0620
MX150 ASSY BLD 2X3 BR C/4	334823613	C-BROWN	GC	PLR	M	-	-	3	NOT RECOMMENDED	SEE 334823642	34950-0610	34950-0620
MX150 ASSY BLD 2X3 GR D/4	334823614	D-GREEN	GC	PLR	M	-	-	3	NOT RECOMMENDED	SEE 334823643	34950-0610	34950-0620
MX150 ASSY BLD 2X3 BK A/5	334823616	A-BLACK	GC	PLR	M	-	-	3	SALEABLE		34950-0610	34950-0620
MX150 ASSY BLD 2X3 BK A/5	334823617	A-BLACK	GC	PLR	M	-	2	-	SALEABLE		34950-0610	34950-0620
MX150 ASSY BLD 2X3 BK A/4	334823618	A-BLACK	GC	PLR	M	-	-	-	SALEABLE		34950-0610	34950-0620
MX150 ASSY BLD 2X3 BK A/2	334823619	A-BLACK	GC	PLR	M	-	2	3	SALEABLE		34950-0610	34950-0620
MX150 ASSY BLD 2X3 BK A/0	334823620	A-BLACK	GC	PLR	M	1	2	3	SALEABLE		34950-0610	34950-0620

ASSEMBLY DESCRIPTION	ASSEMBLY PART NUMBER	COMPONENT				BLOCKED TERMINALS			STATUS	COMMENT	OPTIONAL ATTACHMENTS SOLD SEPARATELY	
		THE PRESENCE OF AN ABBREVIATION INDICATES THE PRESENCE OF THAT COMPONENT				CAVITY WITH A NUMBER INDICATES BLOCKED TERMINAL POSITION CAVITY WITHOUT A NUMBER INDICATES OPEN TERMINAL POSITION					BACKSHELL WITH RIBS	BACKSHELL WITHOUT RIBS
		HOUSING KEY/COLOR	GROMMET CAP	PLR	MAT SEAL							
MX150 ASSY BLD 2X3 BK A/3	334823621	A-BLACK	GC	PLR	M	1	-	-	SALEABLE		34950-0610	34950-0620
MX150 ASSY BLD 2X3 BK A/3	334823622	A-BLACK	GC	PLR	M	4	5	-	SALEABLE		34950-0610	34950-0620
MX150 ASSY BLD 2X3 BK A/5	334823623	A-BLACK	GC	PLR	M	-	-	-	SALEABLE		34950-0610	34950-0620
MX150 ASSY BLD 2X3 BK A/5	334823624	A-BLACK	GC	PLR	M	4	5	6	SALEABLE		34950-0610	34950-0620
MX150 ASSY BLD 2X3 LG B/4	334823625	B-LIGHT GRAY	GC	PLR	M	-	-	-	SALEABLE		34950-0610	34950-0620
MX150 ASSY BLD 2X3 BK A/2	334823626	A-BLACK	GC	PLR	M	-	5	-	SALEABLE		34950-0610	34950-0620
MX150 ASSY BLD 2X3 BK A/2	334823627	A-BLACK	GC	PLR	M	1	-	-	SALEABLE		34950-0610	34950-0620
MX150 ASSY BLD 2X3 DG C/6	334823628	C-DARK GRAY	GC	PLR	M	1	2	3	SALEABLE		34950-0610	34950-0620
MX150 ASSY BLD 2X3 SG D/6	334823629	D-STONE GRAY	GC	PLR	M	4	-	-	SALEABLE		34950-0610	34950-0620
MX150 ASSY BLD 2X3 BK A/4	334823630	A-BLACK	GC	PLR	M	-	2	3	SALEABLE		34950-0610	34950-0620
MX150 ASSY BLD 2X3 XC BK A/6	334823631	A-BLACK	GCL	PLR	M	-	5	6	SALEABLE		34950-0610	34950-0620
MX150 ASSY BLD 2X3 XC LG B/6	334823632	B-LIGHT GRAY	GCL	PLR	M	-	-	-	SALEABLE		34950-0610	34950-0620
MX150 ASSY BLD 2X3 XC DG C/6	334823633	C-DARK GRAY	GCL	PLR	M	-	-	-	SALEABLE		34950-0610	34950-0620
MX150 ASSY BLD 2X3 XC SG D/6	334823634	D-STONE GRAY	GCL	PLR	M	-	-	-	SALEABLE		34950-0610	34950-0620
MX150 ASSY BLD 2X3 XC DG C/5	334823635	C-DARK GRAY	GCL	PLR	M	-	-	3	SALEABLE		34950-0610	34950-0620
MX150 ASSY BLD 2X3 XC BK A/5	334823636	A-BLACK	GCL	PLR	M	-	-	3	SALEABLE		34950-0610	34950-0620
MX150 ASSY BLD 2X3 BK A/4	334823637	A-BLACK	GC	PLR	M	-	2	-	SALEABLE		34950-0610	34950-0620
MX150 ASSY BLD 2X3 DG C/5	334823638	C-DARK GRAY	GC	PLR	M	-	-	6	SALEABLE		34950-0610	34950-0620
MX150 ASSY BLD 2X3 XC BK A/0	334823639	A-BLACK	GCL	PLR	M	-	-	3	SALEABLE		34950-0610	34950-0620
MX150 ASSY BLD 2X3 BK A/5	334823640	A-BLACK	GC	PLR	M	1	2	3	SALEABLE		34950-0610	34950-0620
MX150 ASSY BLD 2X3 SG D/5	334823641	D-STONE GRAY	GC	PLR	M	4	5	6	SALEABLE		34950-0610	34950-0620
MX150 ASSY BLD 2X3 DG C/4	334823642	C-DARK GRAY	GC	PLR	M	-	-	-	SALEABLE		34950-0610	34950-0620
MX150 ASSY BLD 2X3 SG D/4	334823643	D-STONE GRAY	GC	PLR	M	4	-	-	SALEABLE		34950-0610	34950-0620
MX150 ASSY BLD 2X3 YW A/6	334823644	A-YELLOW	GC	PLR	M	-	-	3	SALEABLE		34950-0610	34950-0620
MX150 ASSY BLD 2X3 BK A/2	334823645	A-BLACK	GC	PLR	M	-	-	-	SALEABLE		34950-0610	34950-0620
MX150 ASSY BLD 2X3 BK A/4	334823646	A-BLACK	GC	PLR	M	4	5	6	SALEABLE		34950-0610	34950-0620
MX150 ASSY BLD 2X3 LG B/4	334823647	B-LIGHT GRAY	GC	PLR	M	-	2	3	SALEABLE		34950-0610	34950-0620

ASSEMBLY DESCRIPTION	ASSEMBLY PART NUMBER	COMPONENT				BLOCKED TERMINALS			STATUS	COMMENT	OPTIONAL ATTACHMENTS SOLD SEPARATELY	
		THE PRESENCE OF AN ABBREVIATION INDICATES THE PRESENCE OF THAT COMPONENT				CAVITY WITH A NUMBER INDICATES BLOCKED TERMINAL POSITION CAVITY WITHOUT A NUMBER INDICATES OPEN TERMINAL POSITION					BACKSHELL WITH RIBS	BACKSHELL WITHOUT RIBS
		HOUSING KEY/COLOR	GROMMET CAP	PLR	MAT SEAL							
MX150 ASSY BLD 2X3 DG C/5	334823648	C-DARK GRAY	GC	PLR	M	-	-	-	SALEABLE		34950-0610	34950-0620
MX150 ASSY BLD 2X3 BK A/4	334823649	A-BLACK	GC	PLR	M	-	-	-	SALEABLE		34950-0610	34950-0620
MX150 ASSY BLD 2X3 BK A/3	334823650	A-BLACK	GC	PLR	M	4	-	6	SALEABLE		34950-0610	34950-0620
MX150 ASSY BLD 2X3 BK A/3	334823651	A-BLACK	GC	PLR	M	1	-	3	SALEABLE		34950-0610	34950-0620
MX150 ASSY BLD 2X3 BK A/3	334823651	A-BLACK	GC	PLR	M	-	5	-	SALEABLE		34950-0610	34950-0620
MX150 ASSY BLD 2X3 BK A/4	334823652	A-BLACK	GC	PLR	M	-	2	-	SALEABLE		34950-0610	34950-0620
MX150 ASSY BLD 2X3 BK A/4	334823652	A-BLACK	GC	PLR	M	4	-	6	SALEABLE		34950-0610	34950-0620
MX150 ASSY BLD 2X3 BK A/4	334823653	A-BLACK	GC	PLR	M	1	-	-	SALEABLE		34950-0610	34950-0620
MX150 ASSY BLD 2X3 BK A/4	334823653	A-BLACK	GC	PLR	M	-	2	-	SALEABLE		34950-0610	34950-0620
MX150 ASSY BLD 2X3 BK A/3	334823654	A-BLACK	GC	PLR	M	-	5	-	SALEABLE		34950-0610	34950-0620
MX150 ASSY BLD 2X3 BK A/3	334823654	A-BLACK	GC	PLR	M	1	-	3	SALEABLE		34950-0610	34950-0620
MX150 ASSY BLD 2X3 BK A/1	334823655	A-BLACK	GC	PLR	M	4	-	-	SALEABLE		34950-0610	34950-0620
MX150 ASSY BLD 2X3 BK A/1	334823655	A-BLACK	GC	PLR	M	1	2	3	SALEABLE		34950-0610	34950-0620
MX150 ASSY BLD 2X3 BK A/3	334823656	A-BLACK	GC	PLR	M	-	5	6	SALEABLE		34950-0610	34950-0620
MX150 ASSY BLD 2X3 BK A/3	334823656	A-BLACK	GC	PLR	M	1	2	3	SALEABLE		34950-0610	34950-0620
MX150 ASSY BLD 2X3 BK A/4	334823657	A-BLACK	GC	PLR	M	-	-	-	SALEABLE		34950-0610	34950-0620
MX150 ASSY BLD 2X3 BK A/4	334823657	A-BLACK	GC	PLR	M	4	5	-	SALEABLE		34950-0610	34950-0620
MX150 ASSY BLD 2X3 BK A/5	334823658	A-BLACK	GC	PLR	M	1	-	-	SALEABLE		34950-0610	34950-0620
MX150 ASSY BLD 2X3 BK A/5	334823658	A-BLACK	GC	PLR	M	-	-	-	SALEABLE		34950-0610	34950-0620
MX150 ASSY BLD 2X3 LG B/5	334823659	B-LIGHT GRAY	GC	PLR	M	1	-	-	SALEABLE		34950-0610	34950-0620
MX150 ASSY BLD 2X3 LG B/5	334823659	B-LIGHT GRAY	GC	PLR	M	-	-	-	SALEABLE		34950-0610	34950-0620
MX150 ASSY BLD 2X3 LG B/5	334823660	B-LIGHT GRAY	GC	PLR	M	-	-	-	SALEABLE		34950-0610	34950-0620
MX150 ASSY BLD 2X3 LG B/5	334823660	B-LIGHT GRAY	GC	PLR	M	-	5	-	SALEABLE		34950-0610	34950-0620
MX150 ASSY BLD 2X3 BK A/4	334823661	A-BLACK	GC	PLR	M	1	-	-	SALEABLE		34950-0610	34950-0620
MX150 ASSY BLD 2X3 BK A/4	334823661	A-BLACK	GC	PLR	M	-	5	-	SALEABLE		34950-0610	34950-0620
MX150 ASSY BLD 2X3 BK A/3	334823662	A-BLACK	GC	PLR	M	-	-	3	SALEABLE		34950-0610	34950-0620
MX150 ASSY BLD 2X3 BK A/3	334823662	A-BLACK	GC	PLR	M	4	-	6	SALEABLE		34950-0610	34950-0620
MX150 ASSY BLD 2X3 LG B/4	334823663	B-LIGHT GRAY	GC	PLR	M	-	-	-	SALEABLE		34950-0610	34950-0620
MX150 ASSY BLD 2X3 LG B/4	334823663	B-LIGHT GRAY	GC	PLR	M	-	5	6	SALEABLE		34950-0610	34950-0620
MX150 ASSY BLD 2X3 BK A/5	334823664	A-BLACK	GC	PLR	M	-	-	-	SALEABLE		34950-0610	34950-0620
MX150 ASSY BLD 2X3 BK A/5	334823664	A-BLACK	GC	PLR	M	-	-	6	SALEABLE		34950-0610	34950-0620
MX150 ASSY BLD 2X3 LG B/5	334823665	B-LIGHT GRAY	GC	PLR	M	-	-	-	SALEABLE		34950-0610	34950-0620
MX150 ASSY BLD 2X3 LG B/5	334823665	B-LIGHT GRAY	GC	PLR	M	-	-	6	SALEABLE		34950-0610	34950-0620
MX150 ASSY BLD 2X3 BK A/3	334823666	A-BLACK	GC	PLR	M	-	2	-	SALEABLE		34950-0610	34950-0620
MX150 ASSY BLD 2X3 BK A/3	334823666	A-BLACK	GC	PLR	M	-	5	6	SALEABLE		34950-0610	34950-0620
MX150 ASSY BLD 2X3 BK A/4	334823667	A-BLACK	GC	PLR	M	1	-	-	SALEABLE		34950-0610	34950-0620
MX150 ASSY BLD 2X3 BK A/4	334823667	A-BLACK	GC	PLR	M	4	-	-	SALEABLE		34950-0610	34950-0620
MX150 ASSY BLD 2X3 BK A/3	334823668	A-BLACK	GC	PLR	M	-	2	3	SALEABLE		34950-0610	34950-0620
MX150 ASSY BLD 2X3 BK A/3	334823668	A-BLACK	GC	PLR	M	-	5	-	SALEABLE		34950-0610	34950-0620















**SHEET DESCRIPTION**  
**BACKSHELL NOTES**

BACKSHELL NOTES: VALID UNLESS OTHERWISE SPECIFIED

1. GENERAL:  
a. APPLICATION SPECIFICATION SEE: AS-34951-001  
-DESIGNED TO MATE WITH BLADE SEALED ASSEMBLY SPECIFIED IN MOLEX DRAWING SD-33482-0001.  
-SYSTEM TO BE USED WITH WIRE WITHIN DIAMETER RANGE OF 1.2mm TO 2.69mm.  
-COMPONENTS ARE OPTIONAL AND MUST BE PURCHASED SEPERATELY.  
-DESIGN IS OWNED BY SCHLEMMER FOR SCHLEMMER BACKSHELL.  
-DESIGN IS OWNED BY MOLEX FOR MOLEX BACKSHELL.  
-90° ADAPTOR DESIGN IS OWNED BY MOLEX.  
-FOR ADDITIONAL INFORMATION SEE THE BACKSHELL COMPONENT DRAWING SD-34950-0001.

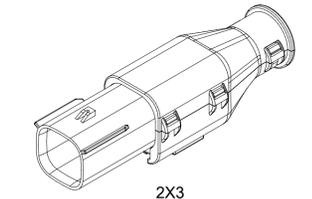

2X3

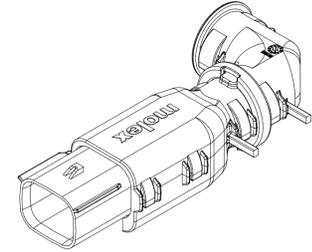

2X4

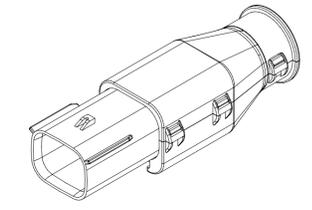

2X4

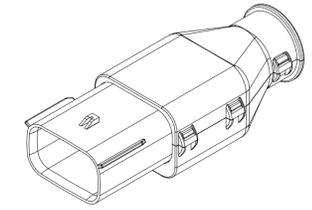

2X6

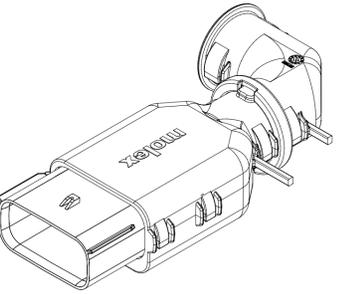

2X8

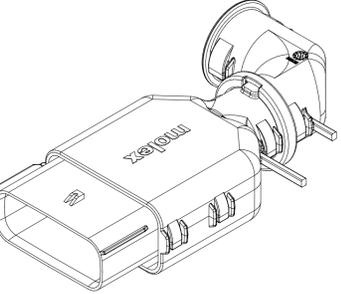

2X10

BACKSHELL CUSTOMER MODEL NUMBER LEGEND

34950-XXXX

- CUSTOMER MODEL COMPONENTS  
0 - SCHLEMMER BACKSHELL ONLY  
1 - SCHLEMMER BACKSHELL & MX150 HOUSING KEY A ASSEMBLY  
2 - SCHLEMMER BACKSHELL & MX150 HOUSING KEY B ASSEMBLY  
3 - SCHLEMMER BACKSHELL & MX150 HOUSING KEY C ASSEMBLY  
4 - SCHLEMMER BACKSHELL & MX150 HOUSING KEY D ASSEMBLY  
5 - MOLEX BACKSHELL ONLY  
6 - MOLEX BACKSHELL & MX150 HOUSING KEY A ASSEMBLY  
7 - MOLEX BACKSHELL & MX150 HOUSING KEY B ASSEMBLY  
8 - MOLEX BACKSHELL & MX150 HOUSING KEY C ASSEMBLY  
9 - MOLEX BACKSHELL & MX150 HOUSING KEY D ASSEMBLY

BACKSHELL FEATURES

- 1 - WITH RIBS  
2 - WITHOUT RIBS  
3 - 90° ADAPTOR

MX150 CIRCUIT SIZE 04, 06, 08, 12, 16, 20

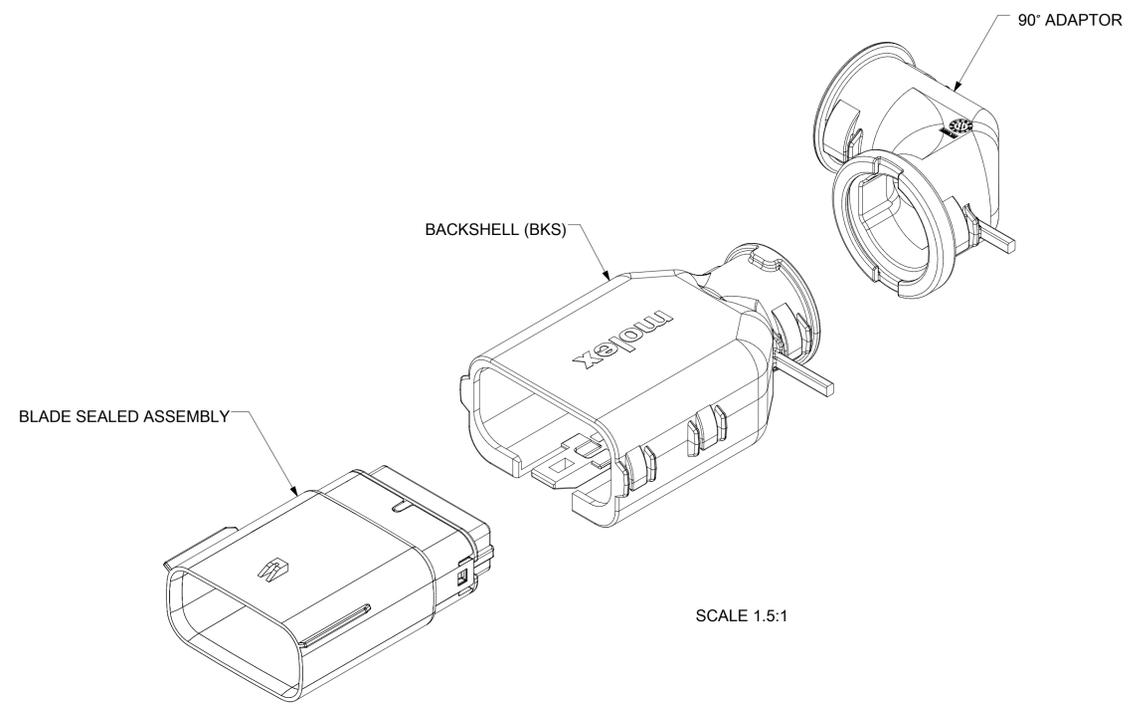

<b>SYMBOLS</b> = 0 = 0 = 0 = 0 = 0 = 0 = 0 = 0 = 0	THIS DRAWING CONTAINS INFORMATION THAT IS PROPRIETARY TO MOLEX ELECTRONIC TECHNOLOGIES, LLC AND SHOULD NOT BE USED WITHOUT WRITTEN PERMISSION		DIMENSION UNITS <b>mm</b>		SCALE <b>1.5:1</b>		CURRENT REV DESC: EC NO: 171650 DRWN: PMANJUNATHAC 2018/01/03 CHK'D: MVANSLAMBROU 2018/02/16 APPR: MVANSLAMBROU 2018/02/16		 MX150 BLADE DUAL ROW SEALED ASSEMBLY MAT SEAL		
	GENERAL TOLERANCES (UNLESS SPECIFIED) ANGULAR TOL ± 1.0°		4 PLACES ± 3 PLACES ± 2 PLACES ± 0.1 1 PLACE ± 0.2 0 PLACES ±		INITIAL REVISION: DRWN: APROFFITT 2014/04/28 APPR: VKOSHY 2014/05/14		PRODUCT CUSTOMER DRAWING				
DRAFT WHERE APPLICABLE MUST REMAIN WITHIN DIMENSIONS		THIRD ANGLE PROJECTION		DRAWING <b>A1-SIZE</b>		SERIES <b>33482</b>		DOCUMENT NUMBER <b>SD-33482-0001</b>		DOC TYPE   DOC PART   REVISION PSD   001   E2	
MATERIAL NUMBER		CUSTOMER		SHEET NUMBER		GENERAL MARKET		7 OF 11			























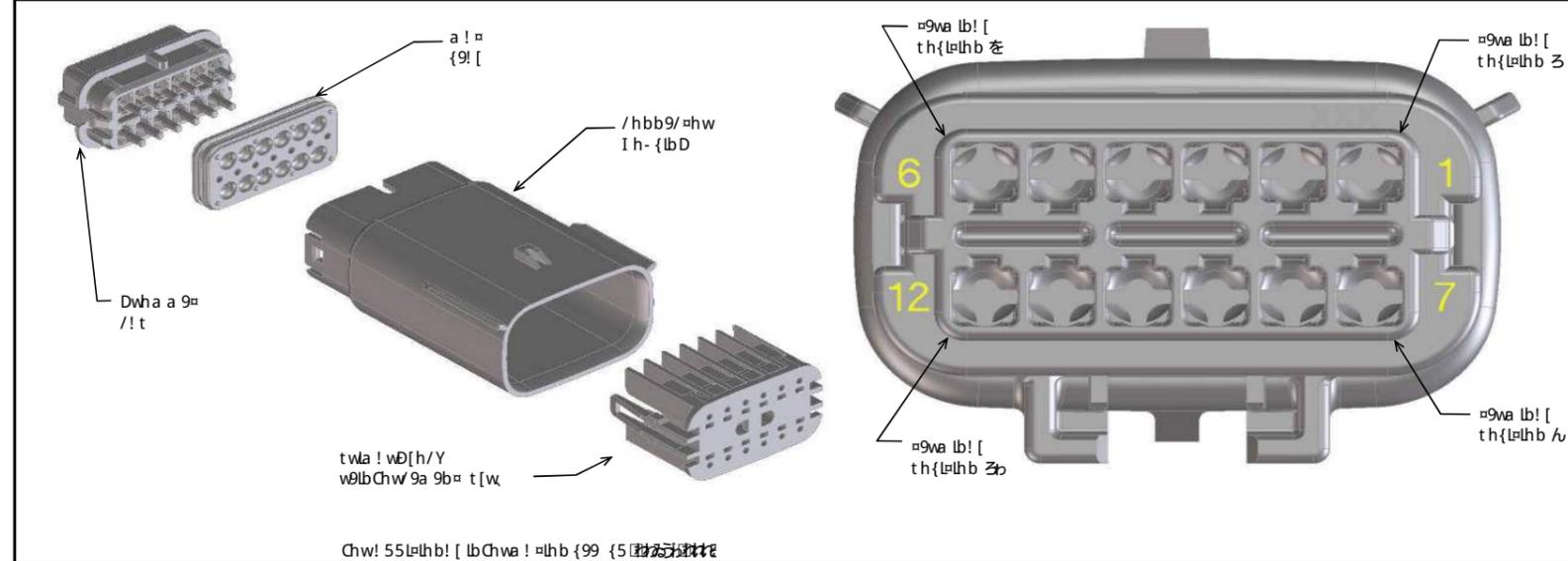

! . w9! ll =lh b	59/wt =lh b	/h[hw	a ! =9wll [
! [Y	I h- {lbDw99bD ht =lh b!	. [! /Y	{t {lbE[hb DC#
. [D	I h- {lbDw99bD ht =lh b .	[lDI = Dw E	{t {lbE[hb DC#
/ [w	I h- {lbDw99bD ht =lh b /	. wh° b	{t {lbE[hb DC#
5 [Dw	I h- {lbDw99bD ht =lh b 5	Dw99b	{t {lbE[hb DC#
! [E	I h- {lbDw99bD ht =lh b !	E9[h°	{t {lbE[hb DC#
/ [SD	I h- {lbDw99bD ht =lh b /	5! wW Dw E	{t {lbE[hb DC#
5 [D	I h- {lbDw99bD ht =lh b 5	{=hb9Dw E	{t {lbE[hb DC#
D/t	Dwha a 9a /! t t[- DD95、	. [! /Y	{t {lbE[hb DC#
t [w	t [w	b! = w [	{t {lbE[hb DC#
a [	a ! =9! [	w {=w95	lbI 9w9b=[D[- . w! ! =95 {ll/hb9
a [	a ! =9! [	whE [ . [- 9	lbI 9w9b=[D[- . w! ! =95 {ll/hb9

! {{9a . [D59/wt =lh b	! {{9a . [Dt! wa b- a . 9w	. [h/Y95 =9wa lb! [ {																{mi = {	/ha a 9b={	ht =lh b! [ ! =! m/I a 9b={ {h5 {9t9w =9 [D			
		/ha thb9b=																		! /Y [I 9 [ ° l [ wL {	! /Y [I 9 [ ° l [ h- = wL {		
! 9tw9b/9hc! b! . . w9! ll =lh b 5L! ! =9 [ =I 9 tw9b/9hc! =! ! /ha thb9b=		I h- {lbD Y9D#h[hw	Dwha a 9a /! t	t [w	a ! =9! [	ろ	わ	わ	ゐ	ゑ	を	ん	う	*	ぢ	ぢ	ぢ						
Y9D! [! /Y	材料仕様	! [Y	D/t	t [w	a [															t [! bb95 h. {h [9/9b/9	{99 材料仕様	材料仕様	材料仕様
Y9D! [DI = Dw E	材料仕様	. [D	D/t	t [w	a [															t [! bb95 h. {h [9/9b/9	{99 材料仕様	材料仕様	材料仕様
Y9D/ [wh° b	材料仕様	/ [w	D/t	t [w	a [															t [! bb95 h. {h [9/9b/9	{99 材料仕様	材料仕様	材料仕様
Y9D5=Dw99b	材料仕様	5 [Dw	D/t	t [w	a [															t [! bb95 h. {h [9/9b/9	{99 材料仕様	材料仕様	材料仕様
1 h15 Y9E	材料仕様																						
Y9D! [! /Y	材料仕様	! [Y	D/t	t [w	a [															t [! bb95 h. {h [9/9b/9	{99 材料仕様	材料仕様	材料仕様
Y9D! [DI = Dw E	材料仕様	. [D	D/t	t [w	a [															t [! bb95 h. {h [9/9b/9	{99 材料仕様	材料仕様	材料仕様
Y9D/ [wh° b	材料仕様	/ [w	D/t	t [w	a [															t [! bb95 h. {h [9/9b/9	{99 材料仕様	材料仕様	材料仕様
Y9D5=Dw99b	材料仕様	5 [Dw	D/t	t [w	a [															t [! bb95 h. {h [9/9b/9	{99 材料仕様	材料仕様	材料仕様
1 h15 Y9E	材料仕様																						
Y9D! [! /Y	材料仕様	! [Y	D/t	t [w	a [															t [! bb95 h. {h [9/9b/9	{99 材料仕様	材料仕様	材料仕様
Y9D! [DI = Dw E	材料仕様	. [D	D/t	t [w	a [															t [! bb95 h. {h [9/9b/9	{99 材料仕様	材料仕様	材料仕様
Y9D/ [wh° b	材料仕様	/ [w	D/t	t [w	a [															t [! bb95 h. {h [9/9b/9	{99 材料仕様	材料仕様	材料仕様
Y9D5=Dw99b	材料仕様	5 [Dw	D/t	t [w	a [															t [! bb95 h. {h [9/9b/9	{99 材料仕様	材料仕様	材料仕様
1 h15 Y9E	材料仕様																						
Y9D! [! /Y	材料仕様	! [Y	D/t	t [w	a [															t [! bb95 h. {h [9/9b/9	{99 材料仕様	材料仕様	材料仕様
Y9D! [DI = Dw E	材料仕様	. [D	D/t	t [w	a [															t [! bb95 h. {h [9/9b/9	{99 材料仕様	材料仕様	材料仕様
Y9D/ [wh° b	材料仕様	/ [w	D/t	t [w	a [															t [! bb95 h. {h [9/9b/9	{99 材料仕様	材料仕様	材料仕様
Y9D5=Dw99b	材料仕様	5 [Dw	D/t	t [w	a [															t [! bb95 h. {h [9/9b/9	{99 材料仕様	材料仕様	材料仕様
1 h15 Y9E	材料仕様																						
Y9D! [! /Y	材料仕様	! [Y	D/t	t [w	a [															t [! bb95 h. {h [9/9b/9	{99 材料仕様	材料仕様	材料仕様
Y9D! [DI = Dw E	材料仕様	. [D	D/t	t [w	a [															t [! bb95 h. {h [9/9b/9	{99 材料仕様	材料仕様	材料仕様
Y9D/ [wh° b	材料仕様	/ [w	D/t	t [w	a [															t [! bb95 h. {h [9/9b/9	{99 材料仕様	材料仕様	材料仕様
Y9D5=Dw99b	材料仕様	5 [Dw	D/t	t [w	a [															t [! bb95 h. {h [9/9b/9	{99 材料仕様	材料仕様	材料仕様
1 h15 Y9E	材料仕様																						
Y9D! [! /Y	材料仕様	! [Y	D/t	t [w	a [															t [! bb95 h. {h [9/9b/9	{99 材料仕様	材料仕様	材料仕様
Y9D! [DI = Dw E	材料仕様	. [D	D/t	t [w	a [															t [! bb95 h. {h [9/9b/9	{99 材料仕様	材料仕様	材料仕様
Y9D/ [wh° b	材料仕様	/ [w	D/t	t [w	a [															t [! bb95 h. {h [9/9b/9	{99 材料仕様	材料仕様	材料仕様
Y9D5=Dw99b	材料仕様	5 [Dw	D/t	t [w	a [															t [! bb95 h. {h [9/9b/9	{99 材料仕様	材料仕様	材料仕様
1 h15 Y9E	材料仕様																						
Y9D! [! /Y	材料仕様	! [Y	D/t	t [w	a [															t [! bb95 h. {h [9/9b/9	{99 材料仕様	材料仕様	材料仕様
Y9D! [DI = Dw E	材料仕様	. [D	D/t	t [w	a [															t [! bb95 h. {h [9/9b/9	{99 材料仕様	材料仕様	材料仕様
Y9D/ [wh° b	材料仕様	/ [w	D/t	t [w	a [															t [! bb95 h. {h [9/9b/9	{99 材料仕様	材料仕様	材料仕様
Y9D5=Dw99b	材料仕様	5 [Dw	D/t	t [w	a [															t [! bb95 h. {h [9/9b/9	{99 材料仕様	材料仕様	材料仕様
1 h15 Y9E	材料仕様																						
Y9D! [! /Y	材料仕様	! [Y	D/t	t [w	a [															t [! bb95 h. {h [9/9b/9	{99 材料仕様	材料仕様	材料仕様
Y9D! [DI = Dw E	材料仕様	. [D	D/t	t [w	a [															t [! bb95 h. {h [9/9b/9	{99 材料仕様	材料仕様	材料仕様
Y9D/ [wh° b	材料仕様	/ [w	D/t	t [w	a [															t [! bb95 h. {h [9/9b/9	{99 材料仕様	材料仕様	材料仕様
Y9D5=Dw99b	材料仕様	5 [Dw	D/t	t [w	a [															t [! bb95 h. {h [9/9b/9	{99 材料仕様	材料仕様	材料仕様
1 h15 Y9E	材料仕様																						
Y9D! [! /Y	材料仕様	! [Y	D/t	t [w	a [															t [! bb95 h. {h [9/9b/9	{99 材料仕様	材料仕様	材料仕様
Y9D! [DI = Dw E	材料仕様	. [D	D/t	t [w	a [															t [! bb95 h. {h [9/9b/9	{99 材料仕様	材料仕様	材料仕様
Y9D/ [wh° b	材料仕様	/ [w	D/t	t [w	a [															t [! bb95 h. {h [9/9b/9	{99 材料仕様	材料仕様	材料仕様
Y9D5=Dw99b	材料仕様	5 [Dw	D/t	t [w	a [															t [! bb95 h. {h [9/9b/9	{99 材料仕様	材料仕様	材料仕様
1 h15 Y9E	材料仕様																						
Y9D! [! /Y	材料仕様	! [Y	D/t	t [w	a [															t [! bb95 h. {h [9/9b/9	{99 材料仕様	材料仕様	材料仕様
Y9D! [DI = Dw E	材料仕様	. [D	D/t	t [w	a [															t [! bb95 h. {h [9/9b/9	{99 材料仕様	材料仕様	材料仕様
Y9D/ [wh° b	材料仕様	/ [w	D/t	t [w	a [															t [! bb95 h. {h [9/9b/9	{99 材料仕様	材料仕様	材料仕様
Y9D5=Dw99b	材料仕様	5 [Dw	D/t	t [w	a [															t [! bb95 h. {h [9/9b/9	{99 材料仕様	材料仕様	材料仕様
1 h15 Y9E	材料仕様																						



Table with columns for phonetic symbols, kana characters, and romanized forms. Includes headers like /ha thb9b= and /h/Y95 =9wa lb! { { and rows of data for various syllables.

Table with multiple columns containing phonetic symbols, kana characters, and numerical/alphabetic codes. The table is organized into several sections with headers like /ha thb9bα and .[h/Y95 α9wa lb! { {.



Table with columns for phonetic symbols, kana characters, and romanized forms. Includes headers like /ha thb9b= and /h/Y95 =9wa lb! { { and rows for various combinations of characters and symbols.







Table with columns for phonetic symbols and kana characters. Headers include /ha thb9b=, . [h/Y95 =9wa lb! [ {, and ht=lhb! [ ! =! /I a 9b= { h5 {9t9w =9D. Rows contain various combinations of symbols and kana like Y9D! ㊦! /Y, ㊦! /Y, etc.



























