

REV.	EN. NO.	DESCRIPTION	SIGN	DATE
C1	N/A	INITIAL DRAWING	Liu	2019/08/13

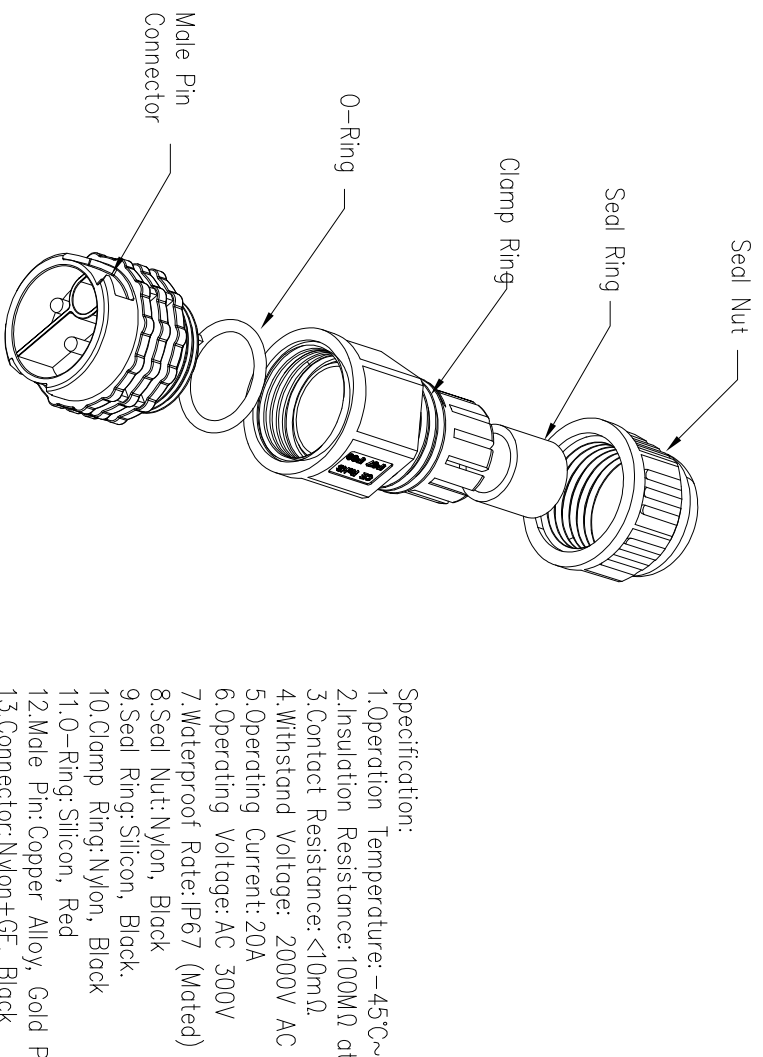
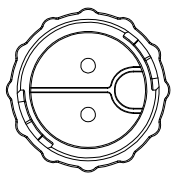
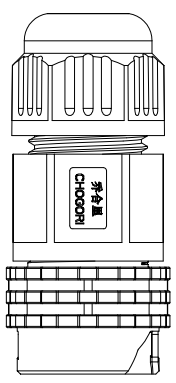
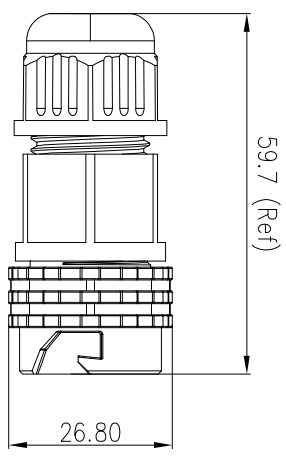

Specification:

- 1.Operation Temperature: -45°C~105°C.
- 2.Insulation Resistance:100MΩ at DC500V.
- 3.Contact Resistance:<10mΩ.
- 4.Withstand Voltage: 2000V AC
- 5.Operating Current:20A
- 6.Operating Voltage:AC 300V
- 7.Waterproof Rate:IP67 (Mated)
- 8.Seal Nut: Nylon, Black
- 9.Seal Ring:Silicon, Black.
- 10.Clamp Ring: Nylon, Black
- 11.O-Ring:Silicon, Red
- 12.Male Pin: Copper Alloy, Gold Plated
- 13.Connector: Nylon+GF, Black
- 14.RoHS Compliant.
- 15.UL Compliant.
- 16.Mating Cap: 806-00068-00

24XXX331-XX Cable Range OD
 01 OD: φ3.5mm~φ6.8mm
 02 OD: φ6.8mm~φ10.5mm
 Pin Number

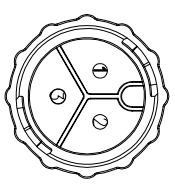
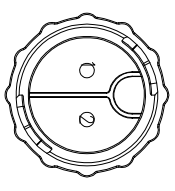

2 Pin
 P/N: 24002331-02

3 Pin
 P/N: 24003331-02

Pin Assignments Front View

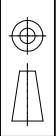

UNIT: mm
 TOLERANCE
 X ±0.25
 XX ±0.15
 XXX ±0.05
 ANGLES ±1°

DESCRIPTION
 Large Series Push Lock
 Female Plug With Male Pin

SCALE: 1:1
 REV: C1
 SIZE: A4
 SHEET: 1 OF 1
 * : Inspection Item

CHOGORI

PART NO
 24XXX331-XX

DWG NO
 CUSTOMER

DRAWN BY
 Liu

CHECKED BY
 Mo
 APPROVED BY
 Panson

DATE
 2019/08/13

DATE
 2019/08/13
 DATE
 2019/08/13