

Digital Fiber Amplifier Unit

E3X-DA-S/MDA

CSM_E3X-DA-S_MDA_DS_E_15_5



Advanced Fiber Amplifier Units

- Features a Power Tuning function that optimizes light reception at the press of a button.
- APC circuits to suppress LED aging degradation used with 4-element LEDs.
- 2-channel models achieve the thinnest* profile in the industry, at only 5 mm per channel.
- 2-channel models also offer AND/OR control output.
- The E3X-MDA0 with two channels supports an EtherCAT Sensor Communications Unit or CompoNet Sensor Communications Unit.

* (Based on July 2012 OMRON investigation.)



Be sure to read *Safety Precautions* on page 15.

Note: As of the end of March 2017, orders of the E3X-DA□SE-S/DA□-S/DA□AT-S/DA□RM-S/DA□TW-S are no longer accepted.
As of the end of March 2019, orders of the E3X-DA□AN-S/DAH□-S/DAB□-S/DAG□-S are no longer accepted.

For the most recent information on models that have been certified for safety standards, refer to your OMRON website.

Features

Models available for a wide variety of applications at manufacturing sites

Industry Leading Two Amplifiers Loaded in a Small Body ··· 2-channel models

Two amplifiers are loaded in a 10 mm-wide body. Space usability can be approximately doubled. In addition, approximately 40% of the energy can be saved. (compared to the value per channel of the former model)



High-speed and High-resolution Analog Output Supports Wide Variety of Applications ··· Advanced Analog Output Models

Analog Control Output

The voltage in the range of 1 to 5 V is output according to the incident level (digital display). Wide variety of applications is possible including positioning control or difference detection with multiple levels.

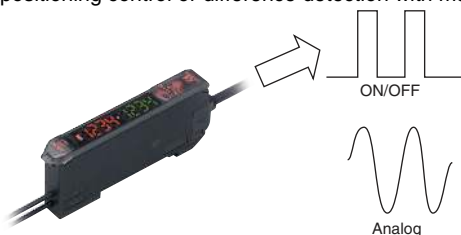

High-speed and High Resolution

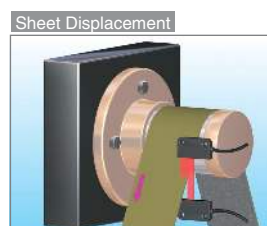

Detection modes can be switched in accordance with applications. High-speed response of 80 μs (super-high-speed mode) supports the positioning controls that require high-speed control.



Ordering Information



Fiber Amplifier Units

Amplifier Units with Cables (2 m) [Refer to Dimensions on page 17.]

Item	Appearance	Functions	Model		
			NPN output	PNP output	
Single-function models		---	E3X-DA11SE-S 2M *	E3X-DA41SE-S 2M *	
Standard models			E3X-DA11-S 2M *	E3X-DA41-S 2M *	
Mark-detecting models (multiple color light sources)		Green LED	Timer, Response speed change	E3X-DAG11-S 2M *	E3X-DAG41-S 2M *
		Blue LED		E3X-DAB11-S 2M *	E3X-DAB41-S 2M *
		Infrared LED		E3X-DAH11-S 2M *	E3X-DAH41-S 2M *
Advanced models		External-input models	Remote setting, counter, differential operation	E3X-DA11RM-S 2M *	E3X-DA41RM-S 2M *
		Twin-output models	Area output, self-diagnosis, differential operation	E3X-DA11TW-S 2M *	E3X-DA41TW-S 2M *
		ATC function models	ATC (Threshold value automatic correction)	E3X-DA11AT-S 2M *	E3X-DA41AT-S 2M *
		Analog output models	Analog output models	E3X-DA11AN-S 2M *	E3X-DA41AN-S 2M *
2-channel models			AND/OR output	E3X-MDA11 2M	E3X-MDA41 2M

* As of the end of March 2017, orders of the E3X-DA□SE-S/DA□S/DA□AT-S/DA□RM-S/DA□TW-S are no longer accepted.
As of the end of March 2019, orders of the E3X-DA□AN-S/DAH□S/DAB□S/DAG□S are no longer accepted.

Amplifier Units with Wire-saving Connectors [Refer to Dimensions on page 18.]

Item	Appearance	Functions	Model		
			NPN output	PNP output	
Single-function models		---	E3X-DA6SE-S *1	E3X-DA8SE-S *1	
Standard models			E3X-DA6-S *1,2	E3X-DA8-S *1,2	
Mark-detecting models (multiple color light sources)		Green LED	Timer, Response speed change	E3X-DAG6-S *1,2	E3X-DAG8-S *1,2
		Blue LED		E3X-DAB6-S *1,2	E3X-DAB8-S *1,2
		Infrared LED		E3X-DAH6-S *1,2	E3X-DAH8-S *1,2
Advanced models		External-input models	Remote setting, counter, differential operation	E3X-DA6RM-S *1,2	E3X-DA8RM-S *1,2
		Twin-output models	Area output, self-diagnosis, differential operation	E3X-DA6TW-S *1,2	E3X-DA8TW-S *1,2
		ATC function models	ATC (Threshold value automatic correction)	E3X-DA6AT-S *1	E3X-DA8AT-S *1
2-channel models			AND/OR output	E3X-MDA6 *2	E3X-MDA8 *2

*1. As of the end of March 2017, orders of the E3X-DA□SE-S/DA□S/DA□AT-S/DA□RM-S/DA□TW-S are no longer accepted.
As of the end of March 2019, orders of the E3X-DA□AN-S/DAH□S/DAB□S/DAG□S are no longer accepted.

*2. These models allow you to use an E3X-DRT21-S VER.3 Sensor Communications Unit. When using the E3X-DRT21-S VER.3, use an E3X-CN02 Connector without a Cable for the Wire-saving Connector.

Amplifier Units with Connectors for EtherCAT or CompoNet Sensor Communications Units [Refer to Dimensions on page 19.]

Item	Appearance	Functions	Model	Applicable Sensor Communications Unit
2-channel model		AND/OR output	E3X-MDA0	E3X-ECT E3X-CRT

Ratings and Specifications

Type	Light source	Response time	Control output/input			Functions					
			ON/OFF output	Input	Analog output	Power tuning	Timer	Interference prevention	Differential detection	counter	ATC
Single-function models	Red LED	1 ms	Only main	---	---	---	---	○	---	---	---
Standard models		50 s to 4 ms									
Mark-detecting models	E3X-DA□G-S	50 s to 4 ms	Only main	---	---	○	○	○	---	---	---
	3X-DA□B-S										
	E3X-DA□H-S										
Advanced models	Red LED	50 s to 4 ms	Main + sub (2 lines)	---	---	○	○	○	○	---	○
		80 s to 4 ms									
		130 s to 4 ms									
		80 s to 4 ms									
2-channel models	Red LED	130 s to 4 ms	Main + main (2 independent lines)	---	---	○	○	○	---	---	---

Accessories (Order Separately)

Amplifier Unit Connectors (Required for models for Wire-saving Connectors.)

Note: Protector seals are provided as accessories. [Refer to *Dimensions* on page 19.]

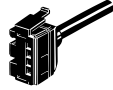
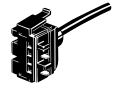
Item	Appearance	Cable length	No. of conductors	Model
Master Connector		2 m	3	E3X-CN11
			4	E3X-CN21
Slave Connector			1	E3X-CN12
			2	E3X-CN22

Ordering Precaution for Amplifier Units with Wire-saving Connectors



Amplifier Units and Connectors are sold separately. Refer to the following tables when placing an order.

Fiber Amplifier Unit			Applicable Connector (Order Separately)	
Model	NPN output	PNP output	Master Connector	Slave Connector
Single-function models	E3X-DA6SE-S	E3X-DA8SE-S	E3X-CN11	E3X-CN12
Standard models	E3X-DA6-S	E3X-DA8-S		
Mark-detecting models (multiple color light sources)	E3X-DAG6-S	E3X-DAG8-S		
	E3X-DAB6-S	E3X-DAB8-S		
	E3X-DAH6-S	E3X-DAH8-S		
Advanced models	E3X-DA6TW-S	E3X-DA8TW-S	E3X-CN21	E3X-CN22
	E3X-DA6RM-S	E3X-DA8RM-S		
	E3X-DA6AT-S	E3X-DA8AT-S		
2-channel models	E3X-MDA6	E3X-MDA8		

When Using 5 Amplifier Units

Fiber Amplifier Units (5 Units)	+	1 Master Connector + 4 Slave Connectors
---------------------------------	---	---

Mobile Console [Refer to *Dimensions* on page 20.]

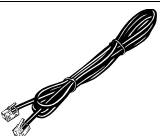
Appearance	Model	Remarks
	E3X-MC11-SV2 (model number of set)	Mobile Console with Head, Cable, and AC adapter provided as accessories
	E3X-MC11-C1-SV2	Mobile Console
	E3X-MC11-H1	Head
	E39-Z12-1	Cable (1.5 m)

Note: Use the E3X-MC11-SV2 Mobile Console for the E3X-DA-S/MDA-series Fiber Amplifier Units.
The E3X-MC11-SV2 is an upgraded version of the E3X-MC11-S that is fully interchangeable with the older model.

Mounting Bracket [Refer to *E39-L/E39-S/E39-R*.]

Appearance	Model	Quantity
	E39-L143	1

End Plate [Refer to *PFP-□*.]

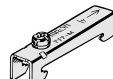
Appearance	Model	Quantity
	PFP-M	1

Ratings and Specifications

Refer to pages 17 to 20 for dimensions.

Fiber Amplifier Units

● Single-function, Standard, and Mark-detecting Amplifier Units

Item	Type	Single-function models E3X-DA□SE-S	Standard models E3X-DA□-S	Mark-detecting models (multiple color light sources)		
	Model			Green LED E3X-DAG□-S	Blue LED E3X-DAB□-S	Infrared LED E3X-DAH□-S
Light source (wavelength)		Red LED (635 nm)		Green LED (525 nm)	Blue LED (470 nm)	Infrared LED (870nm)
Power supply voltage		12 to 24 VDC ±10%, ripple (p-p) 10% max.				
Power consumption		960 mW max. (current consumption: 40 mA max. at power supply voltage of 24 VDC)				
Control output		Load power supply voltage: 26.4 VDC; NPN/PNP open collector; load current: 50 mA max.; residual voltage: 1 V max.				
Remote control input		No-voltage input (contact/non-contact)	---			
Protection circuits		Reverse polarity for power supply connection, output short-circuit				
Re-sponse time	Super-high-speed mode	---	Operate: 48 μs, reset: 50 μs *1,*2			
	High-speed mode	---	Operate/reset: 250 μs			
	Standard mode	Operate or reset: 1 ms				
	High-resolution mode	---	Operate or reset: 4 ms			
Sensitivity setting		Teaching or manual method				
Func-tions	Power tuning	---	Light emission power and reception gain, digital control method			
	Timer function	---	Select from OFF-delay, ON-delay, or one-shot timer. 1 ms to 5 s (1 to 20 ms set in 1-ms increments, 20 to 200 ms set in 10-ms increments, 200 ms to 1 s set in 100-ms increments, and 1 to 5 s set in 1 s-increments)			
	Automatic power control (APC)	High-speed control method for emission current				
	Zero-reset	---	Negative values can be displayed. (Threshold value is shifted.)			
	Initial reset	Settings can be returned to defaults as required.				
	Mutual interference prevention	Possible for up to 10 Units *3				
Display		Operation indicator (orange)	Operation indicator (orange), Power Tuning indicator (orange)			
Digital display		incident level + threshold	Select from incident level + threshold or other 6 patterns			
Display orientation		---	Switching between normal/reversed display is possible.			
Ambient illumination (Receiver side)		Incandescent lamp: 10,000 lux max. Sunlight: 20,000 lux max.				
Ambient temperature range		Operating: Groups of 1 to 2 Amplifiers: -25°C to 55°C Groups of 3 to 10 Amplifiers: -25°C to 50°C Groups of 11 to 16 Amplifiers: -25°C to 45°C Storage: -30°C to 70°C (with no icing or condensation)				
Ambient humidity range		Operating and storage: 35% to 85% (with no condensation)				
Insulation resistance		20 MΩ min. (at 500 VDC)				
Dielectric strength		1,000 VAC at 50/60 Hz for 1 minute				
Vibration resistance		Destruction: 10 to 55 Hz with a 1.5-mm double amplitude for 2 hrs each in X, Y and Z directions				
Shock resistance		Destruction: 500 m/s ² , for 3 times each in X, Y and Z directions				
Degree of protection		IEC 60529 IP50 (with Protective Cover attached)				
Connection method		Pre-wired or amplifier unit connector				
Weight (packed state)		Pre-wired model: Approx. 100 g, Amplifier unit connector model: Approx. 55 g				
Materials	Case	Polybutylene terephthalate (PBT)				
	Cover	Polycarbonate (PC)				
Accessories		Instruction manual				

*1. Communications are disabled if the detection mode is selected during super-high-speed mode, and the communications functions for mutual interference prevention and the Mobile Console will not function.

*2. PNP output is as follows: Operate: 53 μs, reset: 55 μs.

*3. Mutual interference prevention can be used for only up to 6 Units if power tuning is enabled.

● Advanced and 2-channel Amplifier Units

Item	Type Model	Advanced models				2-channel models	
		External input models	Twin output models	ATC function models	Analog output models	Standard models	Model for Sensor Communications Unit *1
		E3X-DA□RM-S	E3X-DA□TW-S	E3X-DA□AT-S	E3X-DA□AN-S	E3X-MDA□ (□: 11/41/6/8)	E3X-MDA0
Light source (wavelength)		Red LED (635 nm)					
Power supply voltage		12 to 24 VDC ±10%, ripple (p-p) 10% max.					
Power consumption		1,080 mW max. (current consumption: 45 mA max. at power supply voltage of 24 VDC)					
Control output	ON/OFF output	Load power supply voltage: 26.4 VDC; NPN/PNP open collector; load current: 50 mA max.; residual voltage: 1 V max.					Supplied from the connector through the Sensor Communications Unit
	Analog output	---			Control output Voltage output: 1 to 5 VDC (Connection load 10 kΩ min.) Temperature characteristics 0.3%F.S./°C Response speed/repeat accuracy Super-high-speed mode: 80 μs/1.5%F.S. High-speed mode: 250 μs/1.5%F.S. Standard mode: 1 ms/1%F.S. High-resolution mode: 4 ms/0.75%F.S.	---	
Remote control input		No-voltage input (contact/transistor) *2	---				
Protection circuits		Reverse polarity for power supply connection, output short-circuit					
Response time	Super-high-speed mode	Operate: 48 μs, reset: 50 μs *3, *4, *5	Operate or reset: 80 μs *3			Operate or reset: 130 μs *3, *6	---
	High-speed mode	Operate or reset: 250 μs				Operate or reset: 450 μs	
	Standard mode	Operate or reset: 1 ms					
	High-resolution mode	Operate or reset: 4 ms					
Sensitivity setting		Teaching or manual method					
Functions	Power tuning	Light emission power and reception gain, digital control method					
	Differential detection	Switchable between single edge and double edge detection mode Single edge: Can be set to 250 μs, 500 μs, 1 ms, 10 ms, or 100 ms. Double edge: Can be set to 500 μs, 1 ms, 2 ms, 20 ms, or 200 ms.				---	
	Timer function	Select from OFF-delay, ON-delay, or one-shot timer. 1 ms to 5 s (1 to 20 ms set in 1-ms increments, 20 to 200 ms set in 10-ms increments, 200 ms to 1 s set in 100-ms increments, and 1 to 5 s set in 1 s-increments)					
	Automatic power control (APC)	High-speed control method for emission current					
	Zero-reset	Negative values can be displayed. (Threshold value is shifted.)					
	Initial reset	Settings can be returned to defaults as required.					
	Mutual interference prevention	Possible for up to 10 Units *7				Possible for up to 9 Units (18 channels) *8	
	Counter	Switchable between up counter and down counter. Set count: 0 to 9,999,999	---				

*1. This model allows you to use an E3X-ECT EtherCAT Sensor Communications Unit or E3X-CRT CompoNet Sensor Communications Unit.

*2. Input Specifications

	Contact input (relay or switch)	Non-contact input (transistor)
NPN	ON: Shorted to 0 V (sourcing current: 1 mA max.). OFF: Open or shorted to Vcc.	ON: 1.5 V max. (sourcing current: 1 mA max.) OFF: Vcc - 1.5 V to Vcc (leakage current: 0.1 mA max.)
PNP	ON: Shorted to Vcc (sinking current: 3 mA max.). OFF: Open or shorted to 0 V.	ON: Vcc - 1.5 V to Vcc (sinking current: 3 mA max.) OFF: 1.5 V max. (leakage current: 0.1 mA max.)

*3. Communications are disabled if the detection mode is selected during super-high-speed mode, and the communications functions for mutual interference prevention and the Mobile Console will not function.

*4. PNP output is as follows: Operate: 53 μs, reset: 55 μs.

*5. When counter is enabled: 80 μs for operate and reset respectively.

*6. When differential output is selected for the output setting, the second channel output is 200 μs for operation and reset respectively.

*7. Mutual interference prevention can be used for only up to 6 Units if power tuning is enabled.

*8. Mutual interference prevention can be used for up to 5 Units (10 channels) if power tuning is enabled.

Item		Type Model	Advanced models				2-channel models	
			External input models	Twin-output models	ATC function models	Analog output models	Standard models	Model for Sensor Communications Unit
			E3X-DA□RM-S	E3X-DA□TW-S	E3X-DA□AT-S	E3X-DA□AN-S	E3X-MDA□ (□: 11/41/6/8)	E3X-MDA0
Functions	I/O setting	External input setting (Select from teaching, power tuning, zero reset, light OFF, or counter reset.)	Output setting (Select from channel 2 output, area output, or self-diagnosis.)	Output setting (Select from channel 2 output, area output, self-diagnosis output, or ATC error output)	Analog output setting (offset voltage adjustable)	Output setting (Select from channel 2 output, AND, OR, leading edge sync, falling edge sync, or differential output)		
Display		Operation indicator (orange), Power Tuning indicator (orange)	Operation indicator for channel 1 (orange), Operation indicator for channel 2 (orange)		Operation indicator (orange), Power Tuning indicator (orange)	Operation indicator for channel 1 (orange), Operation indicator for channel 2 (orange)		
Digital display		Select from incident level + threshold or other 7 patterns	Select from incident level + threshold or other 6 patterns			Select from incident level for channel 1 + incident level for channel 2 or other 7 patterns		
Display orientation		Switching between normal/reversed display is possible.						
Ambient illumination (Receiver side)		Incandescent lamp: 10,000 lux max. Sunlight: 20,000 lux max.						
Ambient temperature range		Operating: Groups of 1 to 2 Amplifiers: -25°C to 55°C Groups of 3 to 10 Amplifiers: -25°C to 50°C Groups of 11 to 16 Amplifiers: -25°C to 45°C *9 Storage: -30°C to 70°C (with no icing or condensation)						
Ambient humidity range		Operating and storage: 35% to 85% (with no condensation)						
Insulation resistance		20 MΩ min. (at 500 VDC)						
Dielectric strength		1,000 VAC at 50/60 Hz for 1 minute						
Vibration resistance (Destruction)		10 to 55 Hz with a 1.5-mm double amplitude for 2 hrs each in X, Y and Z directions				10 to 150 Hz with a 0.7-mm double amplitude for 80 min each in X, Y, and Z directions		
Shock resistance (Destruction)		500 m/s ² , for 3 times each in X, Y and Z directions				200 m/s ² for 3 times each in X, Y, and Z directions		
Degree of protection		IEC 60529 IP50 (with Protective Cover attached)						
Connection method		Pre-wired or amplifier unit connector				Connector for Sensor Communications Unit		
Weight (packed state)		Pre-wired model: Approx. 100 g, Amplifier unit connector model: Approx. 55 g				Approx. 55 g		
Materials	Case	Polybutylene terephthalate (PBT)						
	Cover	Polycarbonate (PC)						
Accessories		Instruction manual						

*9. The following temperature ranges apply for operation when an E3X-ECT or E3X-CRT Sensor Communications Unit is used with the E3X-MDA0: Groups of 1 or 2 Amplifier Units: 0 to 55°C, Groups of 3 to 10 Amplifier Units: 0 to 50°C, Groups of 11 to 16 Amplifier Units: 0 to 45°C, Groups of 17 to 30 Amplifier Units (with the E3X-ECT): 0 to 40°C.

Amplifier Unit Connectors

Item	Model	E3X-CN11/21/22	E3X-CN12
Rated current		2.5 A	
Rated voltage		50 V	
Contact resistance		20 mΩ max. (20 mVDC max., 100 mA max.) (The figure is for connection to the Fiber Amplifier Unit and the adjacent Connector. It does not include the conductor resistance of the cable.)	
No. of insertions		Destruction: 50 times (The figure for the number of insertions is for connection to the Fiber Amplifier Unit and the adjacent Connector.)	
Materials	Housing	Polybutylene terephthalate (PBT)	
	Contacts	Phosphor bronze/gold-plated nickel	
Weight (packed state)		Approx. 55 g	Approx. 25 g

Mobile Console

Item	Model	E3X-MC11-SV2
Applicable Fiber Amplifier Units		E3X-DA-S E3X-MDA E3C-LDA E2C-EDA
Power supply voltage		Charged with AC adapter
Connection method		Connected via adapter
Weight (packed state)		Approx. 580 g (Console only: 120 g)

Refer to *Instruction Manual* provided with the Mobile Console for details.

Sensing Distance

● Single-function, Standard, Advanced, and 2-channel Amplifier Units

Threaded Models

(Unit: mm)

Sensing method	Sensing direction	Size	Model	E3X-DA□-S				E3X-MDA□				
				High-resolution mode	Standard mode	High-speed mode	Super-high-speed mode	High-resolution mode	Standard mode	High-speed mode	Super-high-speed mode	
Through-beam	Right-angle	M4	E32-T11N 2M	700	530	350	140	450	350	230	140	
			E32-LT11N 2M	2,300	1,750	1,150	460	1,500	1,150	750	460	
	Straight		E32-T11R 2M	700	530	350	140	450	350	230	140	
			E32-LT11 2M	2,700	2,050	1,350	540	1,750	1,350	890	540	
Reflective	Right-angle	M3	E32-C31N 2M	40	25	16	7	24	16	10	7	
			E32-C21N 2M	75	65	45	20	50	45	30	20	
		M4	E32-D21N 2M	300	170	120	50	170	120	80	50	
			E32-C11N 2M	280	170	110	50	160	110	70	50	
		M6	E32-LD11N 2M	300	170	120	50	170	120	80	50	
			E32-D21R 2M	50	30	20	8	30	22	14	8	
	Straight	M3	E32-C31 2M	120	75	50	22	75	50	30	22	
			E32-C31M 1M									
			E32-D211R 2M	50	30	20	8	30	22	14	8	
		M4	E32-D11R 2M	300	170	120	50	170	120	80	50	
			M6	E32-CC200 2M	500	300	200	90	300	210	140	90
				E32-LD11 2M	305	180	125	55	175	125	85	55
	E32-LD11R 2M	300	170	120	50	170	120	80	50			

Cylindrical Models

Sensing method	Size	Sensing direction	Model	E3X-DA□-S				E3X-MDA□			
				High-resolution mode	Standard mode	High-speed mode	Super-high-speed mode	High-resolution mode	Standard mode	High-speed mode	Super-high-speed mode
Through-beam	1 dia.	Top-view	E32-T223R 2M	160	130	75	30	110	85	55	30
	1.5 dia.		E32-T22B 2M	240	200	110	45	150	110	70	45
Reflective	3 dia.	Side-view	E32-T12R 2M	700	530	350	140	450	350	230	140
			E32-T14LR 2M	270	210	130	50	170	130	85	50
	1.5 dia.	Top-view	E32-D22B 2M	50	30	20	8	30	22	14	8
			1.5 dia. + 0.5 dia.	E32-D43M 1M	10	6	4	2	6	4	2.5
	E32-D22R 2M			50	30	20	8	30	22	14	8
	3 dia.		E32-D221B 2M	110	70	45	20	70	50	30	20
			E32-D32L 2M	250	150	100	45	150	100	65	45
	3 dia. + 0.8 dia.		E32-D33 2M	25	16	10	4	16	10	6	4

Flat Models

Sensing method	Sensing direction	Model	E3X-DA□-S				E3X-MDA□			
			High-resolution mode	Standard mode	High-speed mode	Super-high-speed mode	High-resolution mode	Standard mode	High-speed mode	Super-high-speed mode
Through-beam	Top-view	E32-T15XR 2M	700	530	350	140	450	350	230	140
	Side-view	E32-T15YR 2M	270	210	130	50	170	130	85	50
	Flat-view	E32-T15ZR 2M								
Reflective	Top-view	E32-D15XR 2M	300	170	120	50	170	120	80	50
	Side-view	E32-D15YR 2M	70	40	26	12	40	29	19	12
	Flat-view	E32-D15ZR 2M								

Note: The super-high-speed mode cannot be used with the E3X-MDA0.

Sleeve Models

Sensing method	Sensing direction	Model	E3X-DA□-S				E3X-MDA□			
			High-resolution mode	Standard mode	High-speed mode	Super-high-speed mode	High-resolution mode	Standard mode	High-speed mode	Super-high-speed mode
Through-beam	Side-view	E32-T24R 2M	60	50	25	10	35	27	18	10
		E32-T24E 2M	160	130	75	30	100	70	45	30
	Top-view	E32-T21-S1 2M	180	150	85	34	120	85	57	34
		E32-T33 1M	53	44	25	10	35	28	18	10
		E32-TC200BR 2M	700	530	350	140	450	350	230	140
Reflective	Side-view	E32-D24R 2M	26	15	10	4	15	10	6	4
		E32-D24-S2 2M	40	26	23	7	26	23	15	7
	Top-view	E32-D43M 1M	10	6	4	2	6	4	2.5	2
		E32-D331 2M	5	3	2	0.8	3	2	1.3	0.8
		E32-D33 2M	25	16	10	4	16	10	6	4
		E32-D32-S1 0.5M	21	13	9	3	14	9	6	3
		E32-D31-S1 0.5M								
		E32-DC200F4R 2M	50	30	20	8	30	22	14	8
		E32-D22-S1 2M	85	55	36	15	56	36	24	15
		E32-D21-S3 2M								
		E32-DC200BR 2M	300	170	120	50	170	120	80	50
E32-D25-S3 2M	85	55	36	15	56	36	24	15		

Small-spot, Reflective

Type	spot diameter	Center distance (mm)	Model	E3X-DA□-S				E3X-MDA□			
				High-resolution mode	Standard mode	High-speed mode	Super-high-speed mode	High-resolution mode	Standard mode	High-speed mode	Super-high-speed mode
Variable spot	0.1 to 0.6 dia.	6 to 5	E32-C42 1M + E39-F3A	Spot diameter of 0.1 to 0.6 mm at 6 to 15 mm.				Spot diameter of 0.1 to 0.6 mm at 6 to 15 mm.			
	0.3 to 1.6 dia.	10 to 30	E32-C42 1M + E39-F17	Spot diameter of 0.3 to 1.6 mm at 10 to 30 mm.				Spot diameter of 0.3 to 1.6 mm at 10 to 30 mm.			
Parallel light	4 dia.	0 to 20	E32-C31 2M + E39-F3C	Spot diameter of 4 mm max. at 0 to 20 mm.				Spot diameter of 4 mm max. at 0 to 20 mm.			
			E32-C31N 2M + E39-F3C								
Integrated lens	0.1 dia.	5	E32-C42S 1M	Spot diameter of 0.1 mm at 5 mm.				Spot diameter of 0.1 mm at 5 mm.			
Small-spot	0.1 dia.	7	E32-C41 1M + E39-F3A-5	Spot diameter of 0.1 mm at 7 mm.				Spot diameter of 0.1 mm at 7 mm.			
	0.5 dia.		E32-C31 2M + E39-F3A-5	Spot diameter of 0.5 mm at 7 mm.				Spot diameter of 0.5 mm at 7 mm.			
			E32-C31N 2M + E39-F3A-5	Spot diameter of 0.5 mm at 7 mm.				Spot diameter of 0.5 mm at 7 mm.			
	0.2 dia.	17	E32-C41 1M + E39-F3B	Spot diameter of 0.2 mm at 17 mm.				Spot diameter of 0.2 mm at 17 mm.			
	0.5 dia.		E32-C31 2M + E39-F3B	Spot diameter of 0.5 mm at 17 mm.				Spot diameter of 0.5 mm at 17 mm.			
			E32-C31N 2M + E39-F3B	Spot diameter of 0.5 mm at 17 mm.				Spot diameter of 0.5 mm at 17 mm.			
3 dia.	50	E32-CC200 2M + E39-F18	Spot diameter of 3 mm at 50 mm.				Spot diameter of 3 mm at 50 mm.				
			E32-C11N 2M + E39-F18	Spot diameter of 3 mm at 50 mm.				Spot diameter of 3 mm at 50 mm.			

Note: The super-high-speed mode cannot be used with the E3X-MDA0.

High-power Beam

Type	Sensing direction	Aperture angle	Model	E3X-DA□-S				E3X-MDA□			
				High-resolution mode	Standard mode	High-speed mode	Super-high-speed mode	High-resolution mode	Standard mode	High-speed mode	Super-high-speed mode
Through-beam Integrated lens	Right-angle	15 °	E32-LT11N 2M	2,300	1,750	1,150	460	1,500	1,150	750	460
		10 °	E32-T17L 10M	20,000 *1	20,000 *1	10,000	4,000	13,000	10,000	6,500	4,000
	Top-view	15 °	E32-LT11 2M	2,700	2,050	1,350	540	1,750	1,350	890	540
			E32-LT11R 2M	2,300	1,750	1,150	460	1,500	1,150	750	460
Side-view	30 °	E32-T14 2M	4,000 *2	3,400	2,250	900	2,900	2,200	1,450	900	
Through-beam models with lenses	Right-angle	12 °	E32-T11N 2M + E39-F1	4,000 *2	3,700	2,400	970	3,100	2,400	1,600	970
		6 °	E32-T11N 2M + E39-F16	4,000 *2	4,000 *2	4,000 *2	1,700	4,000 *2	4,000 *2	2,900	1,700
	Top-view	12 °	E32-T11R 2M + E39-F1	4,000 *2	3,700	2,400	970	3,100	2,400	1,600	970
		6 °	E32-T11R 2M + E39-F16	4,000 *2	4,000 *2	4,000 *2	1,700	4,000 *2	4,000 *2	2,900	1,700
	Side-view	60 °	E32-T11R 2M + E39-F2	520	400	250	100	330	260	170	100
	Top-view	12 °	E32-T11 2M + E39-F1	4,000 *2	3,600	2,300	930	3,000	2,300	1,500	930
		6 °	E32-T11 2M + E39-F16	4,000 *2	4,000 *2	4,000 *2	2,200	4,000 *2	4,000 *2	3,700	2,200
	Side-view	60 °	E32-T11 2M + E39-F2	820	660	430	160	530	430	280	160
	Top-view	12 °	E32-T51R 2M + E39-F1	3,900	2,900	1,900	780	2,500	1,900	1,300	780
		6 °	E32-T51R 2M + E39-F16	4,000 *2	4,000 *2	3,500	1,400	4,000 *2	3,500	2,300	1,400
	Side-view	60 °	E32-T51R 2M + E39-F2	500	380	250	100	320	250	160	100
	Top-view	12 °	E32-T81R-S 2M + E39-F1	4,000 *2	3,200	2,100	840	2,700	2,100	1,380	840
		6 °	E32-T81R-S 2M + E39-F16	4,000 *2	4,000 *2	3,700	1,500	4,000 *2	3,700	2,500	1,500
	Side-view	60 °	E32-T81R-S 2M + E39-F2	540	410	270	100	350	270	170	100
	Top-view	12 °	E32-T61-S 2M + E39-F1	4,000	3,400	2,200	900	3,000	2,200	1,450	900
		6 °	E32-T61-S 2M + E39-F16	4,000 *2	4,000 *2	3,700	1,500	4,000 *2	3,700	2,500	1,500
	Side-view	60 °	E32-T61-S 2M + E39-F2	600	450	300	120	390	300	200	120
	Top-view	12 °	E32-T51 2M + E39-F1-33	4,000 *2	4,000 *2	3,500	1,400	4,000 *2	3,500	2,300	1,400
		6 °	E32-T51 2M + E39-F16	4,000 *2	4,000 *2	4,000 *2	2,500	4,000 *2	4,000 *2	4,000 *2	2,500
	Reflective Integrated lens	Top-view	4 °	E32-D16 2M	40 to 1,000	40 to 700	40 to 450	40 to 240	40 to 600	40 to 490	40 to 300

*1. The fiber length is 10 m on each side, so the sensing distance is given as 20,000 mm.

*2. The fiber length is 2 m on each side, so the sensing distance is given as 4,000 mm.

Narrow View

Sensing method	Sensing direction	Aperture angle	Model	E3X-DA□-S				E3X-MDA□			
				High-resolution mode	Standard mode	High-speed mode	Super-high-speed mode	High-resolution mode	Standard mode	High-speed mode	Super-high-speed mode
Through-beam	Side-view	1.5 °	E32-A03 2M	1,150	890	600	250	750	580	380	250
			E32-A03-1 2M								
		3.4 °	E32-A04 2M	460	340	225	100	300	220	145	100
			E32-T24SR 2M	1,480	1,100	730	290	920	730	480	290
			E32-T24S 2M	1,750	1,300	870	350	1,100	870	580	350
	E32-T22S 2M	2,500	1,900	1,250	500	1,600	1,250	830	500		

Detection without Background Interference

Sensing method	Sensing direction	Model	E3X-DA□-S				E3X-MDA□			
			High-resolution mode	Standard mode	High-speed mode	Super-high-speed mode	High-resolution mode	Standard mode	High-speed mode	Super-high-speed mode
Limited-reflective	Flat-view	E32-L16-N 2M	0 to 15				0 to 12			
		E32-L24S 2M	0 to 4				0 to 4			
	Side-view	E32-L25L 2M	5.4 to 9 (center 7.2)				5.4 to 9 (center 7.2)			

Transparent Object Detection (Retro-reflective)

Sensing method	Feature	Size	Model	E3X-DA□-S				E3X-MDA□			
				High-resolution mode	Standard mode	High-speed mode	Super-high-speed mode	High-resolution mode	Standard mode	High-speed mode	Super-high-speed mode
Retro-reflective	Film detection	M3	E32-C31 2M + E39-F3R + E39-RP37	250	150	100	45	150	100	65	45
	Square	-	E32-R16 2M	150 to 1500				150 to 1500			
	Threaded models	M6	E32-R21 2M	10 to 250				10 to 250			
	Hex-shaped	M6	E32-LR11NP 2M + E39-RP1	630	600	500	275	600	500	330	275

Note: The super-high-speed mode cannot be used with the E3X-MDA0.

Transparent Object Detection (Limited-reflective)

Sensing method	Feature	Sensing direction	Model	E3X-DA□-S				E3X-MDA□			
				High-resolution mode	Standard mode	High-speed mode	Super-high-speed mode	High-resolution mode	Standard mode	High-speed mode	Super-high-speed mode
Limited-reflective	Small size	Flat-view	E32-L24S 2M	0 to 4				0 to 4			
	Standard		E32-L16-N 2M	0 to 15		0 to 12		0 to 15		0 to 12	
	Glass substrate alignment, 70 °C		E32-A08 2M	10 to 20		-		10 to 20		-	
	Standard/long-distance		E32-A12 2M	12 to 30		-		12 to 30		-	
	Side view form	Side-view	E32-L25L 2M	5.4 to 9 (center 7.2)				5.4 to 9 (center 7.2)			
Glass substrate mapping, 70 °C	Top-view	E32-A09 2M	15 to 38		-		15 to 38		-		

Chemical-resistant, Oil-resistant

Sensing method	Type	Sensing direction	Model	E3X-DA□-S				E3X-MDA□			
				High-resolution mode	Standard mode	High-speed mode	Super-high-speed mode	High-resolution mode	Standard mode	High-speed mode	Super-high-speed mode
Through-beam	Oil-resistant	Right-angle	E32-T11NF 2M	4,000 *	4,000 *	2,800	1,100	3,600	2,800	1,800	1,100
	Chemical/oil-resistant	Top-view	E32-T12F 2M	4,000 *	3,000	2,000	800	2,600	2,000	1,300	800
		Side-view	E32-T11F 2M	2,500	2,000	1,300	520	1,600	1,300	850	520
				E32-T14F 2M	500	400	250	100	320	250	160
	Chemical/oil-resistant at 150 °C	Top-view	E32-T51F 2M	1,800	1,400	900	350	1,190	920	600	350
Reflective	Chemical/oil-resistant	Top-view	E32-D12F 2M	160	95	65	30	95	70	45	30
	Chemical-resistant cable		E32-D11U 2M	300	170	120	50	170	125	80	50

* The fiber length is 2 m on each side, so the sensing distance is given as 4,000 mm.

Bending-resistant

Sensing method	Size	Model	E3X-DA□-S				E3X-MDA□			
			High-resolution mode	Standard mode	High-speed mode	Super-high-speed mode	High-resolution mode	Standard mode	High-speed mode	Super-high-speed mode
Through-beam	1.5 dia.	E32-T22B 2M	240	200	110	45	150	110	70	45
	M3	E32-T21 2M								
	M4	E32-T11 2M								
	Square	E32-T25XB 2M	180	150	85	35	125	95	60	35
Reflective	1.5 dia.	E32-D22B 2M	50	30	20	8	30	22	14	8
	M3	E32-D21 2M								
	3 dia.	E32-D221B 2M	110	70	45	20	70	50	30	20
	M4	E32-D21B 2M								
	M6	E32-D11 2M								
		Square	E32-D25XB 2M	85	50	30	15	50	35	23

Heat-resistant

Sensing method	Heat-resistant temperature	Model	E3X-DA□-S				E3X-MDA□			
			High-resolution mode	Standard mode	High-speed mode	Super-high-speed mode	High-resolution mode	Standard mode	High-speed mode	Super-high-speed mode
Through-beam	100 °C	E32-T51R 2M	560	425	280	110	360	280	180	110
	150 °C	E32-T51 2M	1,000	760	500	200	650	500	330	200
	200 °C	E32-T81R-S 2M	360	280	180	70	230	180	120	70
	350 °C	E32-T61-S 2M	600	450	300	120	390	300	200	120
Reflective	100 °C	E32-D51R 2M	240	135	95	40	130	95	60	40
	150 °C	E32-D51 2M	400	230	160	72	230	165	110	72
	200 °C	E32-D81R-S 2M	150	90	60	27	90	63	40	27
	300 °C	E32-A08H2 2M	10 to 20		-		10 to 20		-	
		E32-A09H2 2M	20 to 30		-		20 to 30		-	
	350 °C	E32-D611-S 2M	150	90	60	27	90	63	40	27
		E32-D61-S 2M								
	400 °C	E32-D73-S 2M	100	60	40	18	60	40	25	18

Note: The super-high-speed mode cannot be used with the E3X-MDA0.

Area Beam

Sensing method	Type	Sensing width	Model	E3X-DA□-S				E3X-MDA□			
				High-resolution mode	Standard mode	High-speed mode	Super-high-speed mode	High-resolution mode	Standard mode	High-speed mode	Super-high-speed mode
Through-beam	Area	11 mm	E32-T16PR 2M	1,100	840	560	220	730	560	370	220
			E32-T16JR 2M	980	750	480	190	600	480	320	190
Reflective	Array	11 mm	E32-T16WR 2M	1,700	1,300	850	340	1,100	860	570	340
			E32-D36P1 2M	250	150	100	45	150	100	65	45

Liquid-level Detection

Sensing method	Tube diameter	Feature	Model	E3X-DA□-S				E3X-MDA□			
				High-resolution mode	Standard mode	High-speed mode	Super-high-speed mode	High-resolution mode	Standard mode	High-speed mode	Super-high-speed mode
Tube-mounting	3.2/6.4/9.5 dia.	Stable residual quantity detection	E32-A01 5M	Applicable tube: Transparent tube with a diameter of 3.2, 6.4, or 9.5 mm, Recommended wall thickness: 1 mm				Applicable tube: Transparent tube with a diameter of 3.2, 6.4, or 9.5 mm, Recommended wall thickness: 1 mm			
	8 to 10 dia.	Mounting at multi levels	E32-L25T 2M	Applicable tube: Transparent tube with a diameter of 8 to 10 mm, Recommended wall thickness: 1 mm				Applicable tube: Transparent tube with a diameter of 8 to 10 mm, Recommended wall thickness: 1 mm			
	No restrictions	Large tubes	E32-D36T 2M	Applicable tube: Transparent tube (no restriction on diameter)				Applicable tube: Transparent tube (no restriction on diameter)			
Liquid contact (heat-resistant up to 200 °C)	–	–	E32-D82F1 4M	Liquid-contact Type				Liquid-contact Type			

Vacuum-resistant

Sensing method	Heat-resistant temperature	Model	E3X-DA□-S				E3X-MDA□			
			High-resolution mode	Standard mode	High-speed mode	Super-high-speed mode	High-resolution mode	Standard mode	High-speed mode	Super-high-speed mode
Through-beam	120 °C	E32-T51V 1M	260	200	130	50	170	130	85	50
		E32-T51V 1M + E39-F1V	1,350	1,000	680	260	850	650	430	260
	200 °C	E32-T84SV 1M	630	480	320	130	410	310	200	130

FPD, Semiconductors, and Solar Cells

Sensing method	Application	Operating temperature	Model	E3X-DA□-S				E3X-MDA□			
				High-resolution mode	Standard mode	High-speed mode	Super-high-speed mode	High-resolution mode	Standard mode	High-speed mode	Super-high-speed mode
Limited-reflective	Glass presence detection	70 °C	E32-L16-N 2M	0 to 15			0 to 12	0 to 15			0 to 12
			E32-A08 2M	10 to 20			–	10 to 20			–
	Glass substrate alignment	300 °C	E32-A08H2 2M	12 to 30			–	12 to 30			–
			E32-A12 2M	15 to 38			–	15 to 38			–
	Glass substrate mapping	300 °C	E32-A09 2M	20 to 30			–	20 to 30			–
E32-A09H2 2M											
Through-beam	Wafer mapping	70 °C	E32-A03 2M	1,150	890	600	250	750	580	380	250
			E32-A03-1 2M								
			E32-A04 2M	460	340	225	100	300	220	145	100
			E32-T24SR 2M	1,480	1,100	730	290	920	730	480	290
			E32-T24S 2M	1,750	1,300	870	350	1,100	870	580	350

Note: The super-high-speed mode cannot be used with the E3X-MDA0.

● Mark-detecting Amplifier Units (Different Colors of Light Sources)

Threaded Models

Sensing method	Sensing direction	Size	Model	E3X-DAG□-S/DAB□-S				E3X-DAH□-S			
				High-resolution mode	Standard mode	High-speed mode	Super-high-speed mode	High-resolution mode	Standard mode	High-speed mode	Super-high-speed mode
Through-beam	Right-angle	M4	E32-T11N 2M	65	50	35	30	280	190	130	55
	Straight		E32-T11R 2M								
Reflective	Straight	M3	E32-C31 2M	7.5	6	4	3.5	50	37	25	8.5
		M6	E32-D11R 2M	17	14	10	8	120	90	60	21
			E32-CC200 2M	32	25	16	16	200	150	100	35

Cylindrical Models

Sensing method	Size	Sensing direction	Model	E3X-DAG□-S/DAB□-S				E3X-DAH□-S			
				High-resolution mode	Standard mode	High-speed mode	Super-high-speed mode	High-resolution mode	Standard mode	High-speed mode	Super-high-speed mode
Through-beam	3 dia.	Top-view	E32-T12R 2M	65	50	35	30	280	190	130	55
		Side-view	E32-T14LR 2M	25	20	22	12	100	75	80	21
Reflective	3 dia.	Top-view	E32-D32L 2M	15	12	8	7.5	100	75	50	17

Flat Models

Sensing method	Sensing direction	Model	E3X-DAG□-S/DAB□-S				E3X-DAH□-S			
			High-resolution mode	Standard mode	High-speed mode	Super-high-speed mode	High-resolution mode	Standard mode	High-speed mode	Super-high-speed mode
Through-beam	Top-view	E32-T15XR 2M	65	50	35	30	280	190	130	55
	Side-view	E32-T15YR 2M								
	Flat-view	E32-T15ZR 2M								
Reflective	Top-view	E32-D15XR 2M	17	14	10	8	120	90	60	21
	Side-view	E32-D15YR 2M								
	Flat-view	E32-D15ZR 2M								

Sleeve Models

Sensing method	Sensing direction	Model	E3X-DAG□-S/DAB□-S				E3X-DAH□-S			
			High-resolution mode	Standard mode	High-speed mode	Super-high-speed mode	High-resolution mode	Standard mode	High-speed mode	Super-high-speed mode
Through-beam	Top-view	E32-TC200BR 2M	65	50	35	30	280	190	130	55
Reflective	Top-view	E32-DC200BR 2M	17	14	10	8	120	90	60	21

High-power Beam

Type	Sensing direction	Aperture angle	Model	E3X-DAG□-S/DAB□-S				E3X-DAH□-S			
				High-resolution mode	Standard mode	High-speed mode	Super-high-speed mode	High-resolution mode	Standard mode	High-speed mode	Super-high-speed mode
Through-beam Integrated lens	Side-view	30 °	E32-T14 2M	320	260	220	160	1800	1200	820	360

Output Circuit Diagrams

NPN Output

Model	Operation mode	Timing charts	Operation selector	Output circuit
E3X-DA11-S E3X-DA6-S E3X-DAG11-S E3X-DAG6-S E3X-DAB11-S E3X-DAB6-S E3X-DAH11-S E3X-DAH6-S E3X-DA11SE-S E3X-DA6SE-S	Light-ON		LIGHT ON (L-ON)	
	Dark-ON		DARK ON (D-ON)	
E3X-DA11TW-S E3X-DA6TW-S E3X-MDA11 E3X-MDA6 E3X-DA11AT-S E3X-DA6AT-S	Light-ON		LIGHT ON (L-ON)	
	Dark-ON		DARK ON (D-ON)	
E3X-DA11RM-S E3X-DA6RM-S	Light-ON		LIGHT ON (L-ON)	
	Dark-ON		DARK ON (D-ON)	
E3X-DA11AN-S	Light-ON		LIGHT ON (L-ON)	
	Dark-ON		DARK ON (D-ON)	

Note: 1. The ON/OFF regions when areas settings are used with the E3X-DA□TW-S are as follows:
 LIGHT ON: ON when the incident level is between the thresholds for channels 1 and 2.
 DARK ON: OFF when the incident level is between the thresholds for channels 1 and 2.
 2. Timing Charts for Timer Function Settings (T: Set Time)

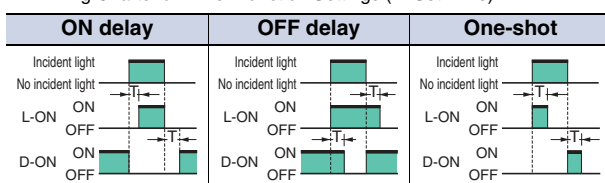

3. Control Output (AND, OR, Sync) and Timing Chart for Timer Settings (T: Set Time)

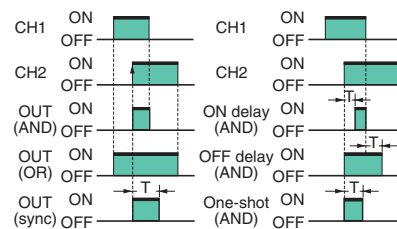

PNP Output

Model	Operation mode	Timing chart	Operation selector	Output circuit
E3X-DA41-S E3X-DA8-S E3X-DAG41-S E3X-DAG8-S E3X-DAB41-S E3X-DAB8-S E3X-DAH41-S E3X-DAH8-S E3X-DA41SE-S E3X-DA8SE-S	Light-ON		LIGHT ON (L-ON)	
	Dark-ON		DARK ON (D-ON)	
E3X-DA41TW-S E3X-DA8TW-S E3X-MDA41 E3X-MDA8 E3X-DA41AT-S E3X-DA8AT-S	Light-ON		LIGHT ON (L-ON)	
	Dark-ON		DARK ON (D-ON)	
E3X-DA41RM-S E3X-DA8RM-S	Light-ON		LIGHT ON (L-ON)	
	Dark-ON		DARK ON (D-ON)	
E3X-DA41AN-S	Light-ON		LIGHT ON (L-ON)	
	Dark-ON		DARK ON (D-ON)	

Note: The ON/OFF regions when areas settings are used with the E3X-DA□TW-S are as follows:
 LIGHT ON: ON when the incident level is between the thresholds for channels 1 and 2.
 DARK ON: OFF when the incident level is between the thresholds for channels 1 and 2.

Nomenclature

Fiber Amplifier Units

E3X-DA□-S

E3X-DA□RM-S

E3X-DA□AN-S

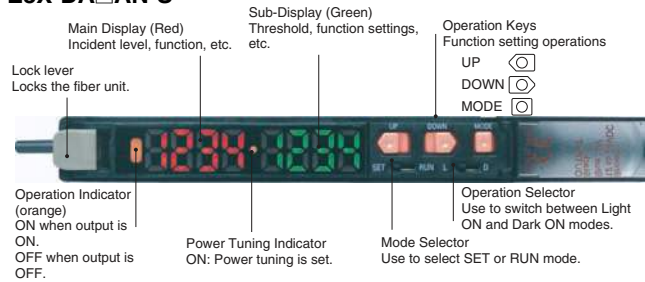

E3X-DA□TW-S

E3X-DA□AT-S

E3X-MDA□

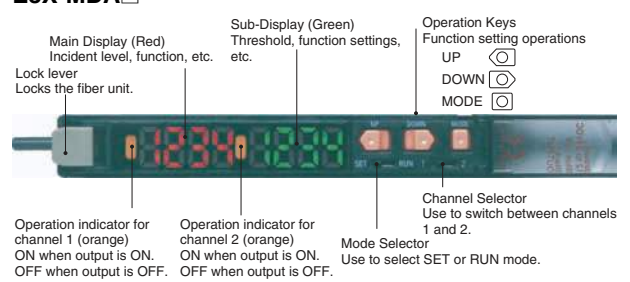

Safety Precautions

Refer to *Warranty and Limitations of Liability*.

⚠ WARNING

This product is not designed or rated for ensuring safety of persons either directly or indirectly. Do not use it for such purposes.



Precautions for Correct Use

Do not use the product in atmospheres or environments that exceed product ratings.

Fiber Amplifier Unit

● Designing

Operation after Turning Power ON

The Sensor is ready to detect 200 ms after the power supply is turned ON. If the Sensor and load are connected to separate power supplies, be sure to turn ON the Sensor first.

● Mounting

Connecting and Disconnecting Wire-saving Connectors

Mounting Connectors

1. Insert the Master or Slave Connector into the Amplifier Unit until it clicks into place.

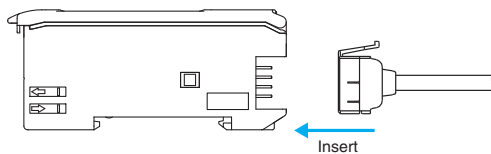

2. Attach the protector seals (provided as accessories) to the sides of master and slave connectors that are not connected.

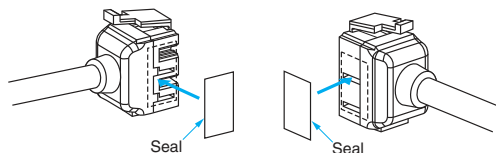

Note: Attach the seals to the sides with grooves.

Removing Connectors

1. Slide the slave Amplifier Unit(s) for which the Connector is to be removed away from the rest of the group.
2. After the Amplifier Unit(s) has been separated, press down on the lever on the Connector and remove it. (Do not attempt to remove Connectors without separating them from other Amplifier Units first.)

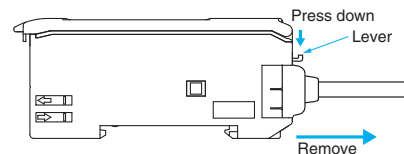

Adding and Removing Fiber Amplifier Units

Adding Fiber Amplifier Units

1. Mount the Amplifier Units one at a time onto the DIN track.

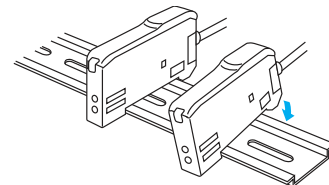

2. Slide the Amplifier Units together, line up the clips, and press the Amplifier Units together until they click into place.

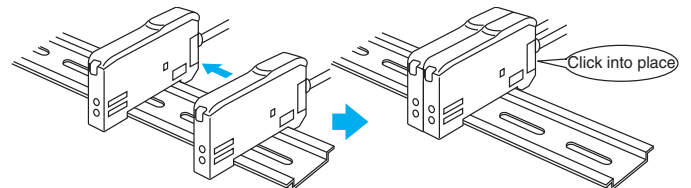

Removing Fiber Amplifier Units

Slide Amplifier Units away from each other, and remove from the DIN track one at a time. (Do not attempt to remove Amplifier Units from the DIN track without separating them first.)

- Note: 1. The specifications for ambient temperature will vary according to the number of Amplifier Units used together. For details, refer to *Ratings and Specifications*.
2. Always turn OFF the power supply before joining or separating Amplifier Units.

Mounting the End Plate (PFP-M)

An End Plate should be used if there is a possibility of the Amplifier Unit moving, e.g., due to vibration. If a Mobile Console is going to be mounted, connect the End Plate in the direction shown in the following diagram.

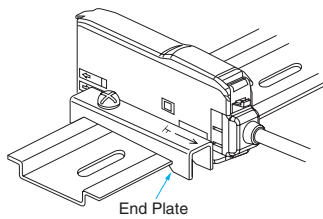

Mounting the Mobile Console Head

Leave a gap of at least 20 mm between the nearest Amplifier Unit and the Mobile Console head.

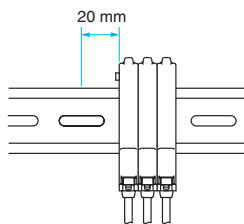

Fiber Unit Connection

The E3X Amplifier Unit has a lock button for easy connection of the Fiber Unit. Connect or disconnect the fiber units using the following procedures:

1. Connection

Open the protective cover, insert the fiber units according to the fiber unit insertion marks on the side of the Amplifier Unit, and lower the lock lever.

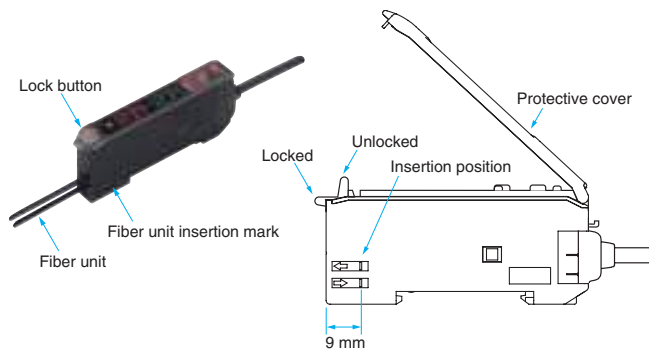

Note: If one of the fibers from the Fiber Unit is labeled as the Emitter fiber, such as with a Coaxial Sensor, insert that fiber into the Emitter section. Refer to *Dimensions for the Fiber Unit* to see if there is an Emitter fiber label.

Fiber Units with E39-F9 Attachment

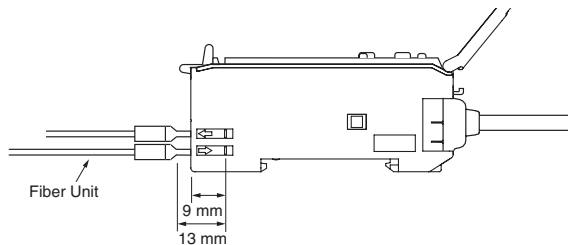

Fiber Units That Cannot Be Free-Cut (with Sleeves)

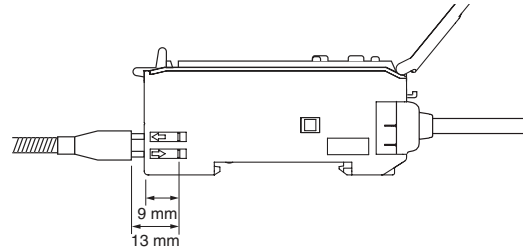

2. Disconnecting Fiber Units

Remove the protective cover and raise the lock lever to pull out the fiber units.

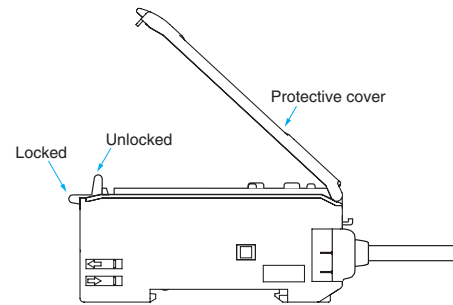

Note: 1. To maintain the fiber unit properties, confirm that the lock is released before removing the fiber units.
2. Be sure to lock or unlock the lock button within an ambient temperature range between -10°C and 40°C .

● Adjusting

Mutual Interference Protection Function

There may be some instability in the digital display values due to light from other sensors. If this occurs, decrease the sensitivity (i.e., decrease the power or increase the threshold) to perform stable detection.

EEPROM Writing Error

If the data is not written to the EEPROM correctly due to a power failure or static-electric noise, initialize the settings with the keys on the Amplifier Unit. ERR/EEP will flash on the display when a writing error has occurred.

Optical Communications

Several Amplifier Units can be slid together and used in groups. Do not, however, slide the Amplifier Units or attempt to remove any of the Amplifier Units during operation.

● Others

Protective Cover

Always keep the protective cover in place when using the Amplifier Unit.

Mobile Console

Use the E3X-MC11-SV2 Mobile Console for the E3X-DA-S-series Amplifier Units.

Dimensions

Fiber Amplifier Units

Amplifier Units with Cables

- E3X-DA11-S
- E3X-DA41-S
- E3X-DAG11-S
- E3X-DAG41-S
- E3X-DAB11-S
- E3X-DAB41-S
- E3X-DAH11-S
- E3X-DAH41-S
- E3X-DA11RM-S
- E3X-DA41RM-S
- E3X-DA11TW-S
- E3X-DA41TW-S
- E3X-DA11SE-S
- E3X-DA41SE-S
- E3X-DA11AT-S
- E3X-DA41AT-S
- E3X-DA11AN-S
- E3X-DA41AN-S
- E3X-MDA11
- E3X-MDA41



Area of digital indication

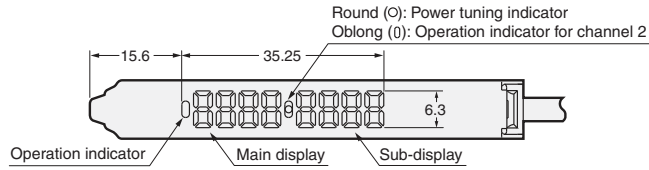

DIN track mounting

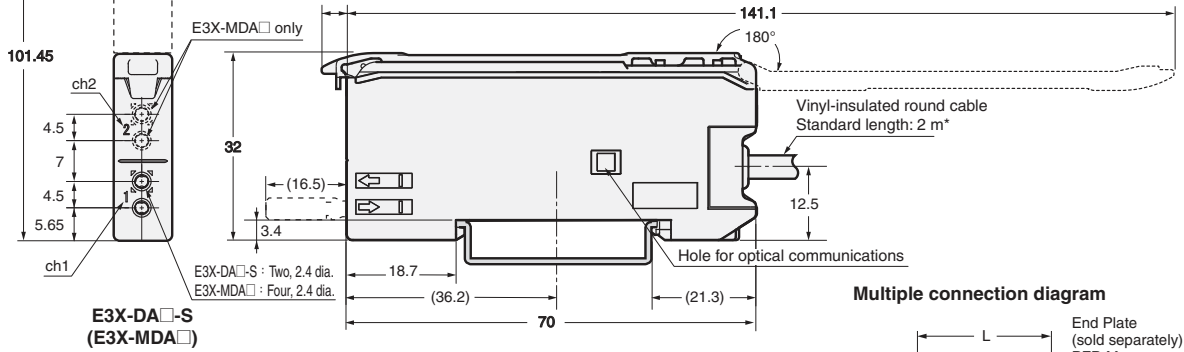

Multiple connection diagram

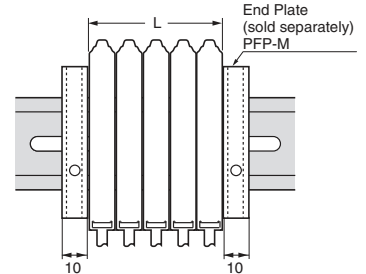

The number of expansion	L (mm)
1	10
2	20
3	30
4	40
5	50
6	60
7	70
8	80
9	90
10	100

* Cable Specifications

E3X-DA11-S -DA41-S -DAG11-S -DAG41-S -DAB11-S -DAB41-S -DAH11-S -DAH41-S	4-dia., 3-conductor (Conductor cross section: 0.2 mm ² , insulator diameter: 1.1 mm)
E3X-DA11TW-S -DA41TW-S -DA11RM-S -DA41RM-S	4-dia., 4-conductor (Conductor cross section: 0.2 mm ² , insulator diameter, 1.1 mm)
E3X-MDA11 -MDA41	4-dia., 2-conductor (Conductor cross section: 0.2 mm ² , insulator diameter: 1.1 mm)

With Mounting Bracket Attached

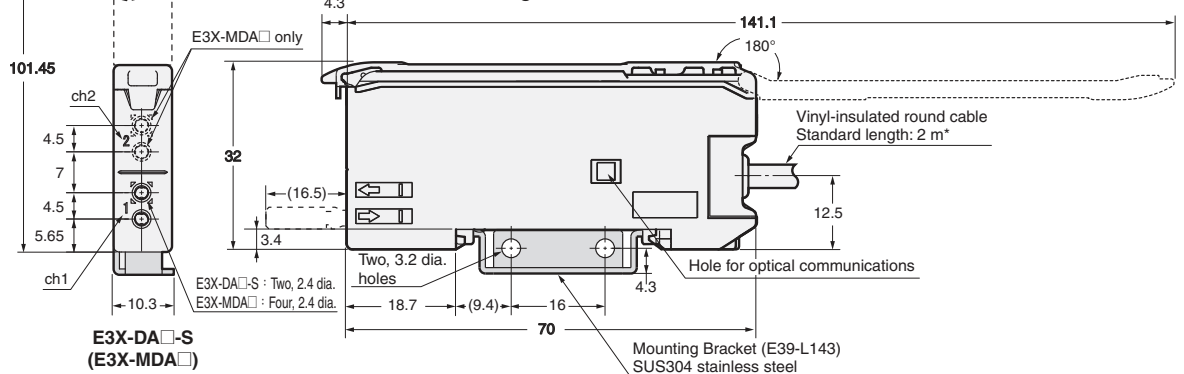

Mounting Holes

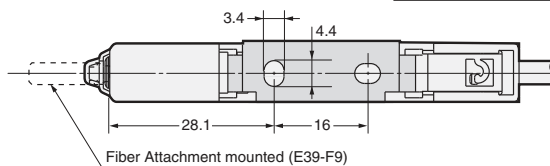
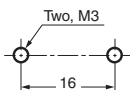

Note: When using E39-L143 Mounting Brackets, there will be small gaps between the Fiber Amplifier Units if they are mounted side by side.

Amplifier Units with Wire-saving Connectors

- E3X-DA6-S
- E3X-DA8-S
- E3X-DAG6-S
- E3X-DAG8-S
- E3X-DAB6-S
- E3X-DAB8-S
- E3X-DAH6-S
- E3X-DAH8-S
- E3X-DA6RM-S
- E3X-DA8RM-S
- E3X-DA6TW-S
- E3X-DA8TW-S
- E3X-DA6SE-S
- E3X-DA8SE-S
- E3X-DA6AT-S
- E3X-DA8AT-S
- E3X-MDA6
- E3X-MDA8

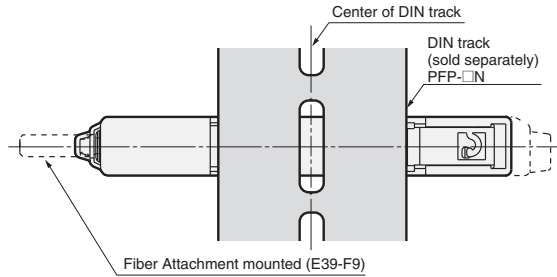
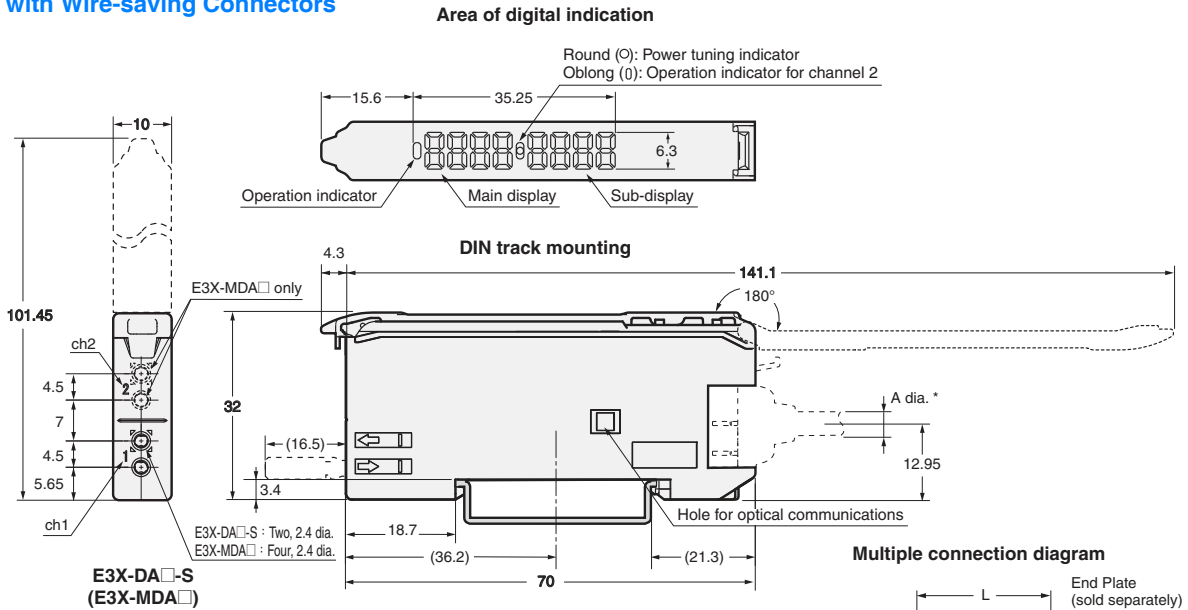

* Cable Diameters

E3X-CN22 (2 conductors)	4.0-mm dia.
E3X-CN21 (4 conductors)	
E3X-CN11 (3 conductors)	
E3X-CN12 (1 conductor)	2.6-mm dia.

Multiple connection diagram

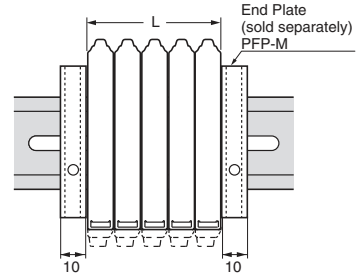

The number of expansion	L (mm)
1	10
2	20
3	30
4	40
5	50
6	60
7	70
8	80
9	90
10	100

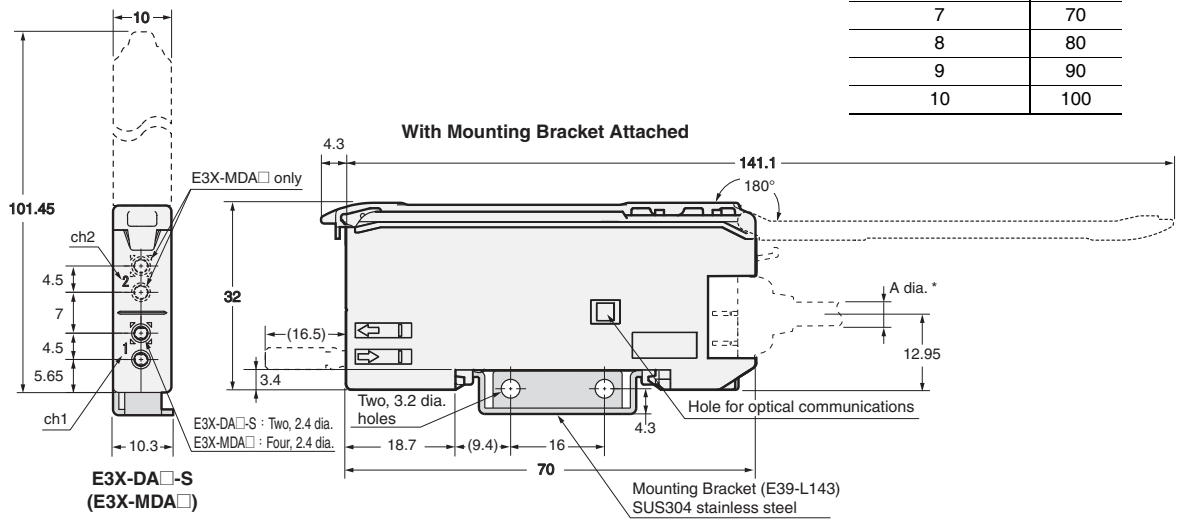

Mounting Holes

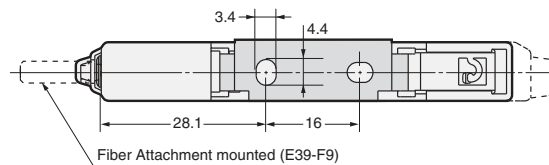
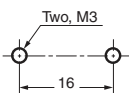

Note: When using E39-L143 Mounting Brackets, there will be small gaps between the Fiber Amplifier Units if they are mounted side by side.

Amplifier Unit with Connector for Sensor Communications Unit E3X-MDA0

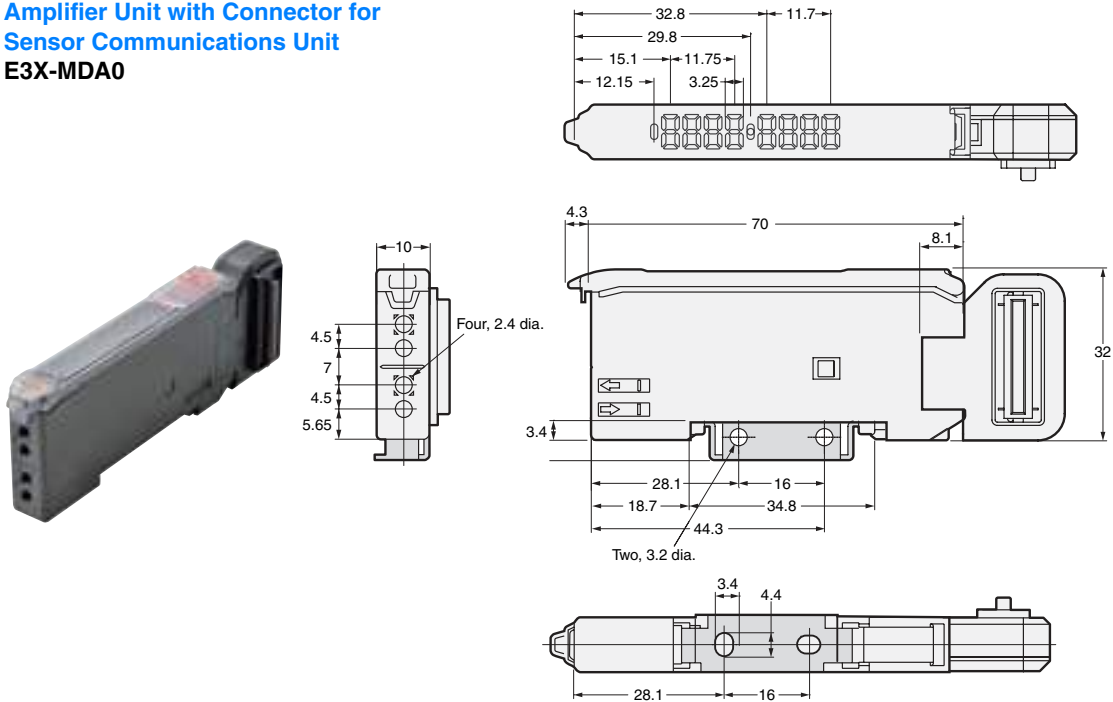

Amplifier Unit Connectors

Master Connectors

E3X-CN11
E3X-CN21

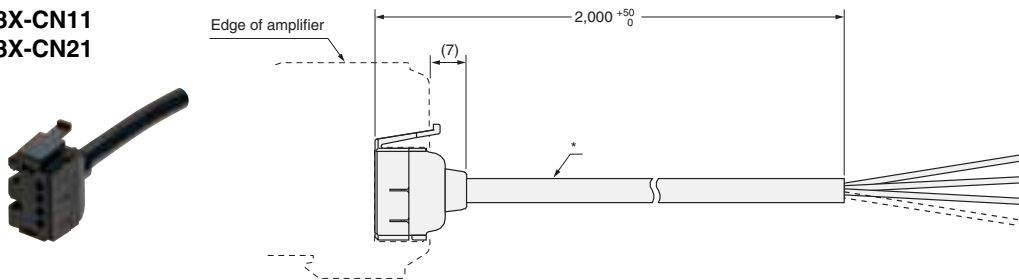

* E3X-CN11: **4 dia.** cable / **3 conductors** / Standard length: 2 m (Conductor cross section: 0.2 mm² (AWG24), Insulator diameter: 1.1 mm)
E3X-CN21: **4 dia.** cable / **4 conductors** / Standard length: 2 m (Conductor cross section: 0.2 mm² (AWG24), Insulator diameter: 1.1 mm)

Slave Connectors

E3X-CN12
E3X-CN22

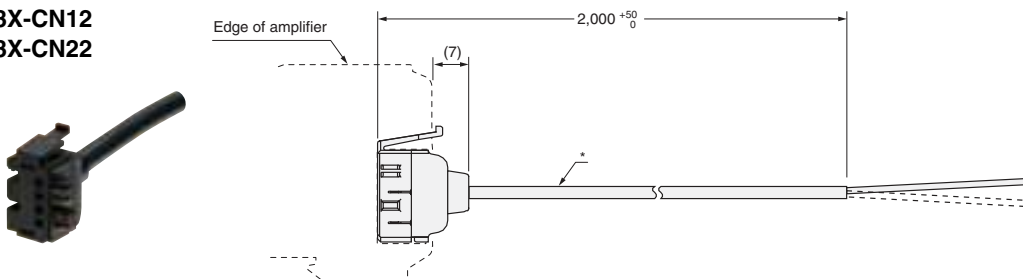

* E3X-CN12: **2.6 dia.** cable / **1 conductor** / Standard length: 2 m (Conductor cross section: 0.2 mm² (AWG24), Insulator diameter: 1.1 mm)
E3X-CN22: **4 dia.** cable / **2 conductors** / Standard length: 2 m (Conductor cross section: 0.2 mm² (AWG24), Insulator diameter: 1.1 mm)

Mobile Console

E3X-MC11-SV2

Mobile Console

Mobile Console Head

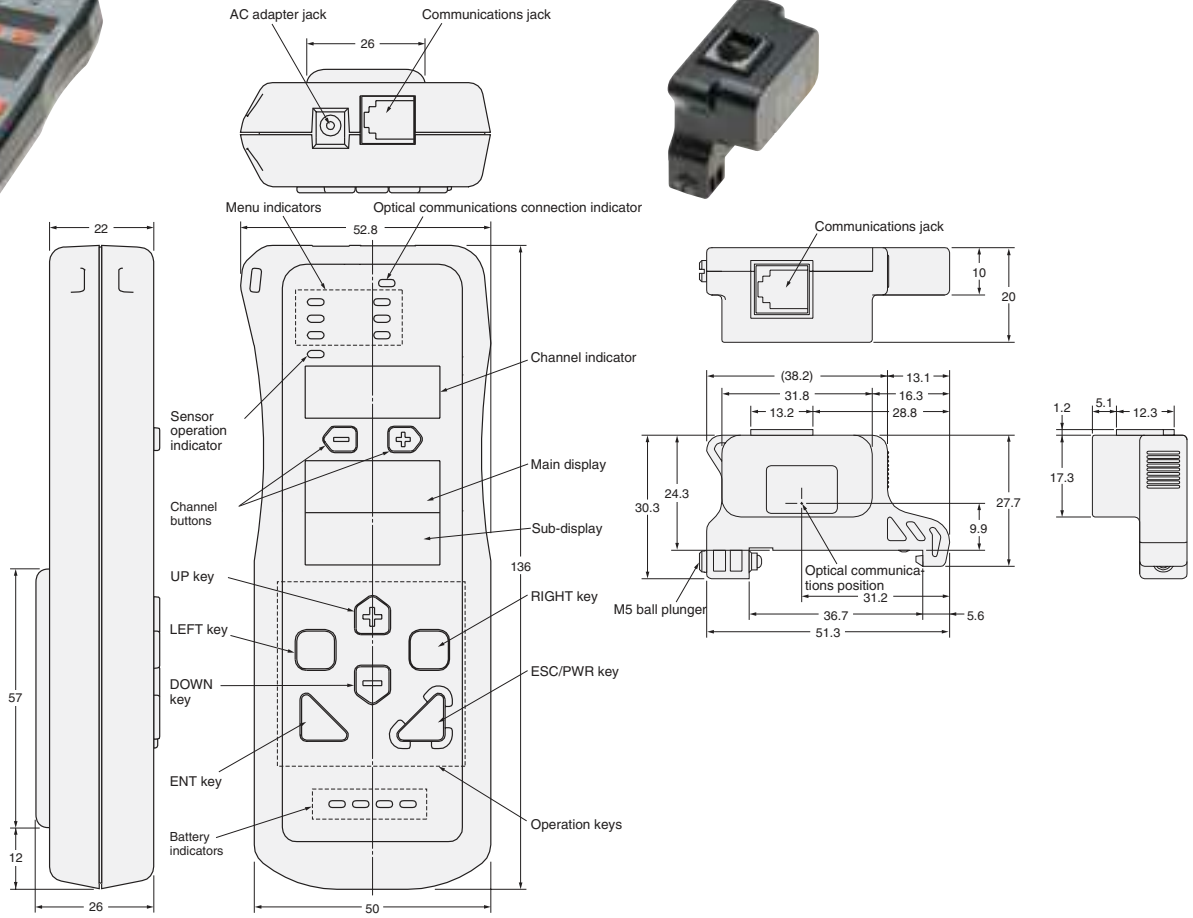

Refer to *E32 Series* for details on Fiber Units.

Terms and Conditions Agreement

Read and understand this catalog.

Please read and understand this catalog before purchasing the products. Please consult your OMRON representative if you have any questions or comments.

Warranties.

(a) Exclusive Warranty. Omron's exclusive warranty is that the Products will be free from defects in materials and workmanship for a period of twelve months from the date of sale by Omron (or such other period expressed in writing by Omron). Omron disclaims all other warranties, express or implied.

(b) Limitations. OMRON MAKES NO WARRANTY OR REPRESENTATION, EXPRESS OR IMPLIED, ABOUT NON-INFRINGEMENT, MERCHANTABILITY OR FITNESS FOR A PARTICULAR PURPOSE OF THE PRODUCTS. BUYER ACKNOWLEDGES THAT IT ALONE HAS DETERMINED THAT THE PRODUCTS WILL SUITABLY MEET THE REQUIREMENTS OF THEIR INTENDED USE.

Omron further disclaims all warranties and responsibility of any type for claims or expenses based on infringement by the Products or otherwise of any intellectual property right. (c) Buyer Remedy. Omron's sole obligation hereunder shall be, at Omron's election, to (i) replace (in the form originally shipped with Buyer responsible for labor charges for removal or replacement thereof) the non-complying Product, (ii) repair the non-complying Product, or (iii) repay or credit Buyer an amount equal to the purchase price of the non-complying Product; provided that in no event shall Omron be responsible for warranty, repair, indemnity or any other claims or expenses regarding the Products unless Omron's analysis confirms that the Products were properly handled, stored, installed and maintained and not subject to contamination, abuse, misuse or inappropriate modification. Return of any Products by Buyer must be approved in writing by Omron before shipment. Omron Companies shall not be liable for the suitability or unsuitability or the results from the use of Products in combination with any electrical or electronic components, circuits, system assemblies or any other materials or substances or environments. Any advice, recommendations or information given orally or in writing, are not to be construed as an amendment or addition to the above warranty.

See <http://www.omron.com/global/> or contact your Omron representative for published information.

Limitation on Liability: Etc.

OMRON COMPANIES SHALL NOT BE LIABLE FOR SPECIAL, INDIRECT, INCIDENTAL, OR CONSEQUENTIAL DAMAGES, LOSS OF PROFITS OR PRODUCTION OR COMMERCIAL LOSS IN ANY WAY CONNECTED WITH THE PRODUCTS, WHETHER SUCH CLAIM IS BASED IN CONTRACT, WARRANTY, NEGLIGENCE OR STRICT LIABILITY.

Further, in no event shall liability of Omron Companies exceed the individual price of the Product on which liability is asserted.

Suitability of Use.

Omron Companies shall not be responsible for conformity with any standards, codes or regulations which apply to the combination of the Product in the Buyer's application or use of the Product. At Buyer's request, Omron will provide applicable third party certification documents identifying ratings and limitations of use which apply to the Product. This information by itself is not sufficient for a complete determination of the suitability of the Product in combination with the end product, machine, system, or other application or use. Buyer shall be solely responsible for determining appropriateness of the particular Product with respect to Buyer's application, product or system. Buyer shall take application responsibility in all cases.

NEVER USE THE PRODUCT FOR AN APPLICATION INVOLVING SERIOUS RISK TO LIFE OR PROPERTY OR IN LARGE QUANTITIES WITHOUT ENSURING THAT THE SYSTEM AS A WHOLE HAS BEEN DESIGNED TO ADDRESS THE RISKS, AND THAT THE OMRON PRODUCT(S) IS PROPERLY RATED AND INSTALLED FOR THE INTENDED USE WITHIN THE OVERALL EQUIPMENT OR SYSTEM.

Programmable Products.

Omron Companies shall not be responsible for the user's programming of a programmable Product, or any consequence thereof.

Performance Data.

Data presented in Omron Company websites, catalogs and other materials is provided as a guide for the user in determining suitability and does not constitute a warranty. It may represent the result of Omron's test conditions, and the user must correlate it to actual application requirements. Actual performance is subject to the Omron's Warranty and Limitations of Liability.

Change in Specifications.

Product specifications and accessories may be changed at any time based on improvements and other reasons. It is our practice to change part numbers when published ratings or features are changed, or when significant construction changes are made. However, some specifications of the Product may be changed without any notice. When in doubt, special part numbers may be assigned to fix or establish key specifications for your application. Please consult with your Omron's representative at any time to confirm actual specifications of purchased Product.

Errors and Omissions.

Information presented by Omron Companies has been checked and is believed to be accurate; however, no responsibility is assumed for clerical, typographical or proofreading errors or omissions.