

ACPDQC3V3T-HF

RoHS Device
Halogen Free



Features

- Bi-directional ESD protection.
- IEC 61000-4-2 ±30kV(Contact).
- ESD Rating of Class 3 per Human Body Model.
- ESD Rating of Class 4 per Machine Model.
- Surface mount package.
- Ultra small SMD package:0402
- High component density.
- Comply with AEC-Q101

Mechanical data

- Case: 0402C/SOD-923 Standard package, molded plastic.
- Terminals: Matte tin plated, solderable per MIL-STD-750, method 2026.
- Mounting position: Any.
- Weight: 0.001 grams(approx.).

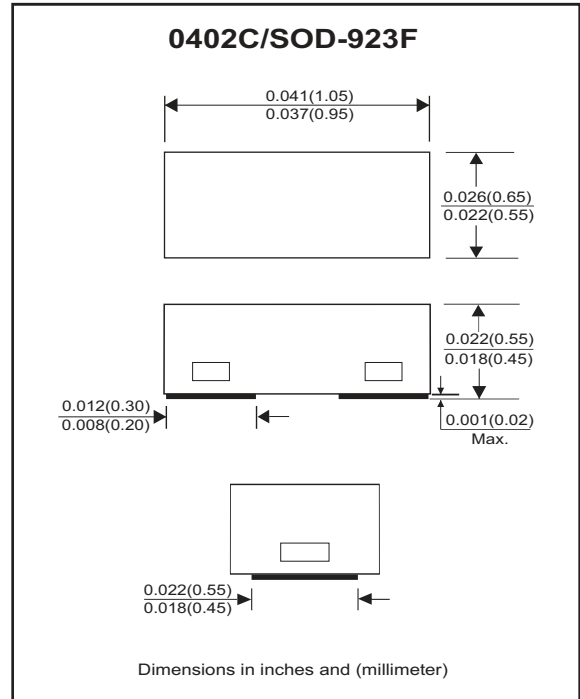

Circuit diagram



Maximum Rating (at TA=25°C unless otherwise noted)

Parameter	Conditions	Symbol	Value	Unit
Peak pulse power	T _P = 8/20us	P _{PP}	170	W
Peak pulse current	T _P = 8/20us	I _{PP}	16	A
ESD capability	IEC 61000-4-2(air)	ESD	±30	kV
	IEC 61000-4-2(contact)	ESD	±30	
Operation temperature range		T _J	-40~+125	°C
Storage temperature range		T _{STG}	-55~+150	°C

Electrical Characteristics (at TA=25°C unless otherwise noted)

Parameter	Conditions	Symbol	Min	Typ	Max	Unit
Working peak reverse voltage		V _{RWM}			3.3	V
Breakdown voltage	I _T = 1mA	V _{BR}	3.6	4.2	4.6	V
Reverse leakage current	V _{RWM} = 3.3V	I _R		<0.02	0.5	uA
Clamping voltage	I _{PP} = 1A, T _P = 8/20us	V _C		4.65		V
	I _{PP} = 16A, T _P = 8/20us			9.8		
Clamping voltage	I _{PP} = 5A, T _P = 100ns	V _{CL}		6		V
	I _{PP} = 18A, T _P = 100ns			8.75		
Dynamic resistance		RDYN		0.18		Ω
Junction capacitance	V _R = 0V, f = 1MHz	C _J		20	25	pF

RATING AND CHARACTERISTIC CURVES (ACPDQC3V3T-HF)

Fig.1 - 8/20us Peak Pulse Current Waveform ACC. IEC 61000-4-5

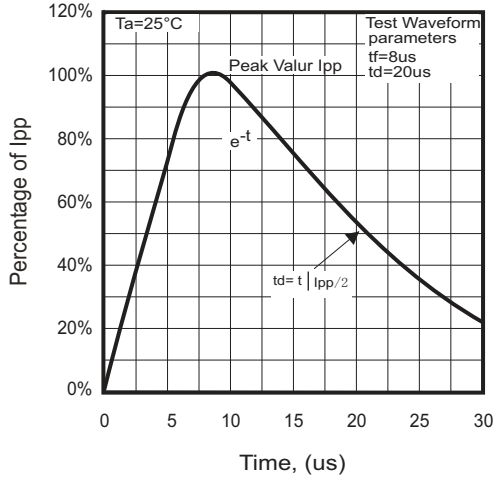

Fig.2 - Typical Capacitance Between Terminals Characteristics

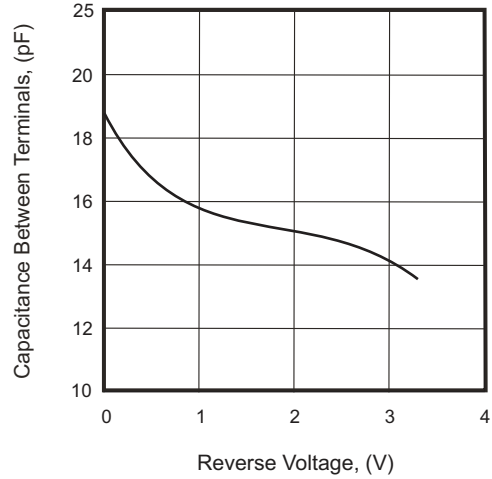

Fig.3 - Clamping Voltage Vs. Peak Pulse Current

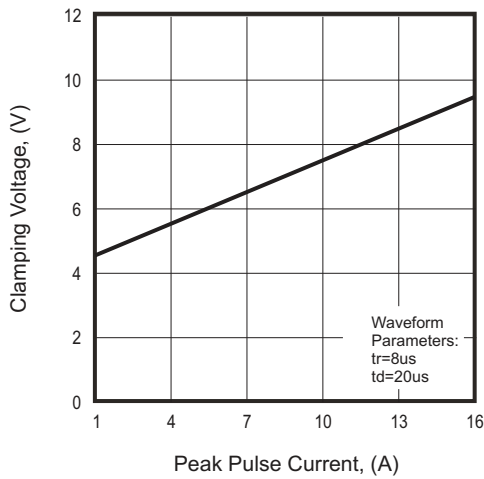

Fig.4 - Power Rating Derating Curve

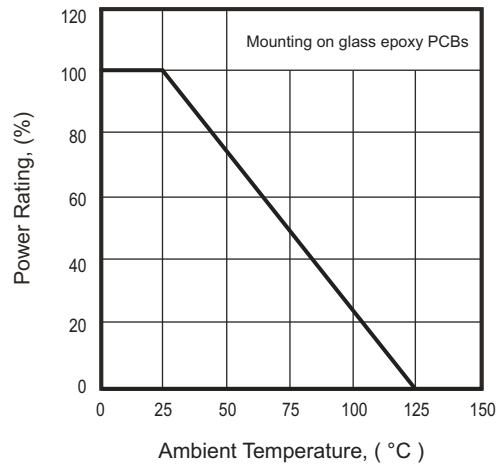

Fig. 5 - Pin1 To Pin2

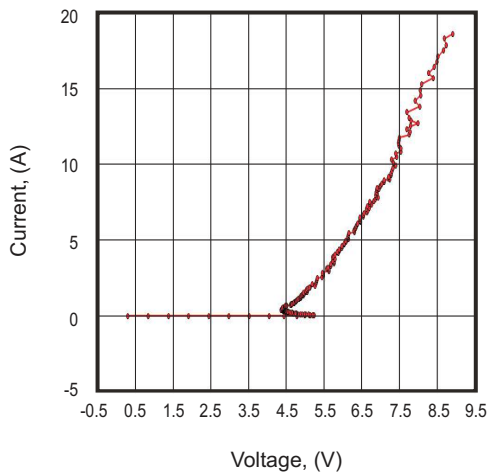
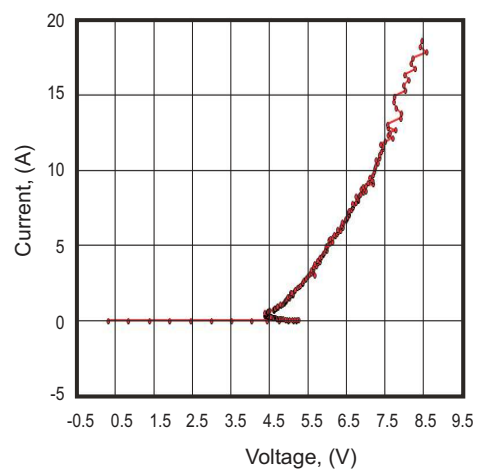
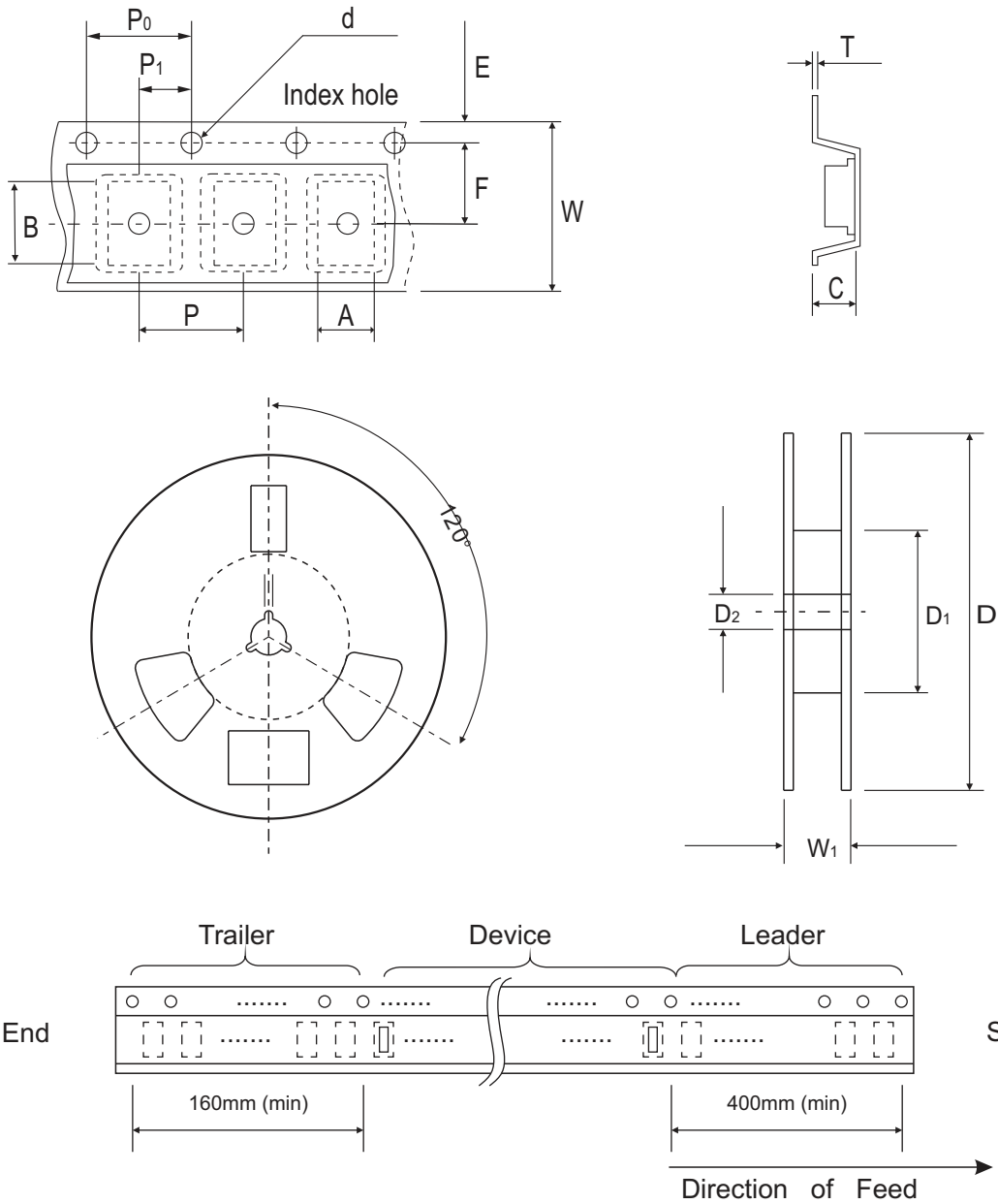

Fig.6 - Pin2 To Pin1



Reel Taping Specification



0402C (SOD-923F)	SYMBOL	A	B	C	d	D	D ₁	D ₂
	(mm)	0.75 ± 0.05	1.17 ± 0.05	0.65 ± 0.05	1.50 + 0.10 - 0	178.00 ± 1.00	60.00 ± 0.50	13.50 ± 0.20
	(inch)	0.030 ± 0.002	0.046 ± 0.002	0.026 ± 0.002	0.059 + 0.004 - 0	7.008 ± 0.039	2.362 ± 0.020	0.531 ± 0.008

0402C (SOD-923F)	SYMBOL	E	F	P	P ₀	P ₁	T	W	W ₁
	(mm)	1.75 ± 0.10	3.50 ± 0.10	4.00 ± 0.10	4.00 ± 0.10	2.00 ± 0.10	0.20 + 0.02 - 0.05	8.00 ± 0.20	12.00 + 0.50 - 0
	(inch)	0.069 ± 0.004	0.138 ± 0.004	0.157 ± 0.004	0.157 ± 0.004	0.079 ± 0.004	0.008 + 0.001 - 0.002	0.315 ± 0.008	0.472 + 0.020 - 0

Company reserves the right to improve product design, functions and reliability without notice.

REV:A

Marking Code

Part Number	Marking Code
ACPDQC3V3T-HF	E3



Suggested PAD Layout

SIZE	0402C/SOD-923F	
	(mm)	(inch)
A	0.70	0.028
B	0.40	0.016
C	0.70	0.028
D	1.10	0.043
E	0.30	0.012

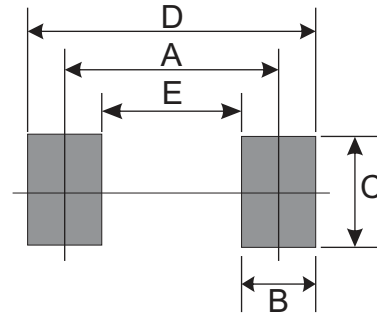

Standard Packaging

Case Type	REEL PACK	
	REEL (pcs)	Reel Size (inch)
0402C/SOD-923F	5,000	7