

MSC035SMA170B Silicon Carbide N-Channel Power MOSFET

Product Overview

The silicon carbide (SiC) power MOSFET product line from Microsemi increases the performance over silicon MOSFET and silicon IGBT solutions while lowering the total cost of ownership for high-voltage applications. The MSC035SMA170B device is a 1700 V, 35 mΩ SiC MOSFET in a TO-247 package.

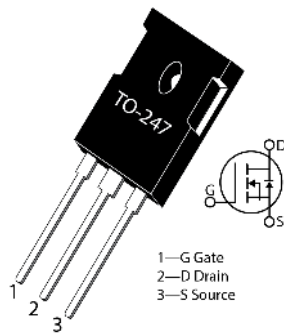

Features

The following are key features of the MSC035SMA170B device:

- Low capacitances and low gate charge
- Fast switching speed due to low internal gate resistance (ESR)
- Stable operation at high junction temperature, $T_{J(max)} = 175\text{ °C}$
- Fast and reliable body diode
- Superior avalanche ruggedness
- RoHS compliant

Benefits

The following are benefits of the MSC035SMA170B device:

- High efficiency to enable lighter, more compact system
- Simple to drive and easy to parallel
- Improved thermal capabilities and lower switching losses
- Eliminates the need for external freewheeling diode
- Lower system cost of ownership

Applications

The MSC035SMA170B device is designed for the following applications:

- PV inverter, converter, and industrial motor drives
- Smart grid transmission and distribution
- Induction heating and welding
- H/EV powertrain and EV charger
- Power supply and distribution

Device Specifications

This section shows the specifications of the MSC035SMA170B device.

Absolute Maximum Ratings

The following table shows the absolute maximum ratings of the MSC035SMA170B device.

Table 1 • Absolute Maximum Ratings

Symbol	Characteristic	Ratings	Unit
V _{DSS}	Drain source voltage	1700	V
I _D	Continuous drain current at T _C = 25 °C	68	A
	Continuous drain current at T _C = 100 °C	48	
I _{DM}	Pulsed drain current ¹	200	
V _{GS}	Gate-source voltage	23 to -10	V
P _D	Total power dissipation at T _C = 25 °C	370	W
	Linear derating factor	2.47	W/°C

Note:

1. Repetitive rating: pulse width and case temperature limited by maximum junction temperature.

The following table shows the thermal and mechanical characteristics of the MSC035SMA170B device.

Table 2 • Thermal and Mechanical Characteristics

Symbol	Characteristic	Min	Typ	Max	Unit
R _{θJC}	Junction-to-case thermal resistance		0.27	0.41	°C/W
T _J	Operating junction temperature	-55		175	°C
T _{STG}	Storage temperature	-55		150	
T _L	Soldering temperature for 10 seconds (1.6 mm from case)			260	
	Mounting torque, 6-32 or M3 screw			10	lbf-in
				1.1	N-m
Wt	Package weight		0.22		oz
			6.2		g

Electrical Performance

The following table shows the static characteristics of the MSC035SMA170B device. $T_J = 25\text{ }^\circ\text{C}$ unless otherwise specified.

Table 3 • Static Characteristics

Symbol	Characteristic	Test Conditions	Min	Typ	Max	Unit
$V_{(BR)DSS}$	Drain-source breakdown voltage	$V_{GS} = 0\text{ V}, I_D = 100\text{ }\mu\text{A}$	1700			V
$R_{DS(on)}$	Drain-source on resistance ¹	$V_{GS} = 20\text{ V}, I_D = 30\text{ A}$		35	45	m Ω
$V_{GS(th)}$	Gate-source threshold voltage	$V_{GS} = V_{DS}, I_D = 2.5\text{ mA}$	1.8	3.25		V
$\Delta V_{GS(th)}/\Delta T_J$	Threshold voltage coefficient	$V_{GS} = V_{DS}, I_D = 2.5\text{ mA}$		-5.1		mV/ $^\circ\text{C}$
I_{DSS}	Zero gate voltage drain current	$V_{DS} = 1700\text{ V}, V_{GS} = 0\text{ V}$			100	μA
		$V_{DS} = 1700\text{ V}, V_{GS} = 0\text{ V}$ $T_J = 125\text{ }^\circ\text{C}$			500	
I_{GSS}	Gate-source leakage current	$V_{GS} = 20\text{ V}/-10\text{ V}$			± 100	nA

Note:

1. Pulse test: pulse width < 380 μs , duty cycle < 2%.

The following table shows the dynamic characteristics of the MSC035SMA170B device. $T_J = 25\text{ }^\circ\text{C}$ unless otherwise specified.

Table 4 • Dynamic Characteristics

Symbol	Characteristic	Test Conditions	Min	Typ	Max	Unit
C_{iss}	Input capacitance	$V_{GS} = 0\text{ V}, V_{DD} = 1000\text{ V}$ $V_{AC} = 25\text{ mV}, f = 1\text{ MHz}$		3300		pF
C_{rss}	Reverse transfer capacitance			10		
C_{oss}	Output capacitance			150		
Q_g	Total gate charge	$V_{GS} = -5\text{ V}/20\text{ V}, V_{DD} = 850\text{ V}$ $I_D = 30\text{ A}$		178		nC
Q_{gs}	Gate-source charge			49		
Q_{gd}	Gate-drain charge			27		
$t_{d(on)}$	Turn-on delay time	$V_{DD} = 1300\text{ V}, V_{GS} = -5\text{ V}/20\text{ V}$ $I_D = 50\text{ A}, R_{G(ext)} = 4\text{ }\Omega^1$, Freewheeling diode = MSC035SMA170B ($V_g = -5\text{ V}$)		9		ns
t_r	Current rise time			10		
$t_{d(off)}$	Turn-off delay time			15		

Symbol	Characteristic	Test Conditions	Min	Typ	Max	Unit	
t_f	Current fall time			17			
E_{on}	Turn-on switching energy ²			2025		μ J	
E_{off}	Turn-off switching energy			366			
$t_{d(on)}$	Turn-on delay time	$V_{DD} = 1300$ V, $V_{GS} = -5$ V/20 V $I_D = 50$ A, $R_{G(ext)} = 4$ Ω ¹ , Freewheeling diode = MSC050SDA170B		9		ns	
t_r	Current rise time			10			
$t_{d(off)}$	Turn-off delay time			15			
t_f	Current fall time			17			
E_{on}	Turn-on switching energy ²				1712		μ J
E_{off}	Turn-off switching energy				278		
ESR	Equivalent series resistance	$f = 1$ MHz, 25 mV, drain short		0.85		Ω	
SCWT	Short circuit withstand time	$V_{DS} = 1200$ V, $V_{GS} = 20$ V		3		μ s	
E_{AS}	Avalanche energy, single pulse	$V_{DS} = 150$ V, $V_{GS} = 20$ V, $I_D = 30$ A		4000		mJ	

Notes:

1. R_G is total gate resistance excluding internal gate driver impedance.
2. E_{on} includes energy of the freewheeling diode.

The following table shows the body diode characteristics of the MSC035SMA170B device. $T_J = 25\text{ }^\circ\text{C}$ unless otherwise specified.

Table 5 • Body Diode Characteristics

Symbol	Characteristic	Test Conditions	Min	Typ	Max	Unit
V_{SD}	Diode forward voltage	$I_{SD} = 30\text{ A}, V_{GS} = 0\text{ V}$		3.7		V
		$I_{SD} = 30\text{ A}, V_{GS} = -5\text{ V}$		3.9		V
t_{rr}	Reverse recovery time	$I_{SD} = 50\text{ A}, V_{GS} = -5\text{ V},$ $V_{DD} = 1200\text{ V}, dI/dt = -8000\text{ A}/\mu\text{s}$		27		ns
Q_{rr}	Reverse recovery charge			650		nC
I_{RRM}	Reverse recovery current			46		A

Typical Performance Curves

This section shows the typical performance curves of the MSC035SMA170B device.

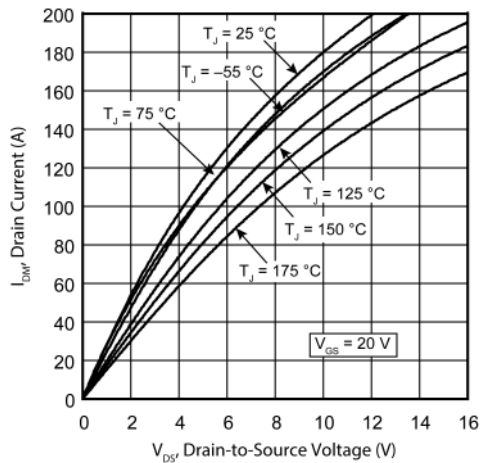

Figure 1 • Drain Current vs. V_{DS}

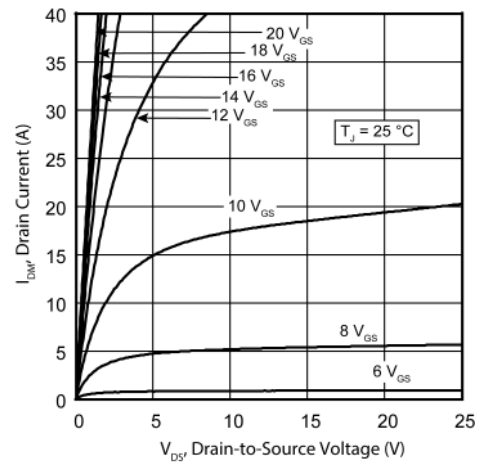

Figure 2 • Drain Current vs. V_{DS}

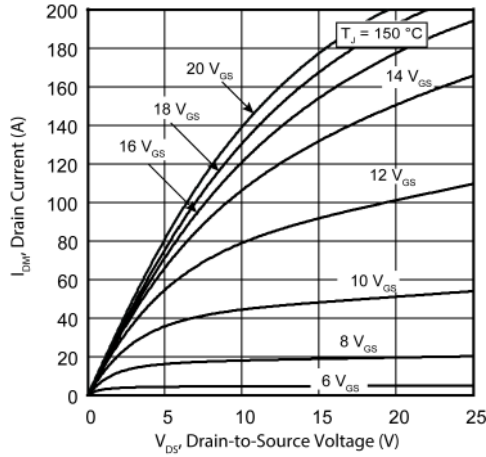

Figure 3 • Drain Current vs. V_{DS}

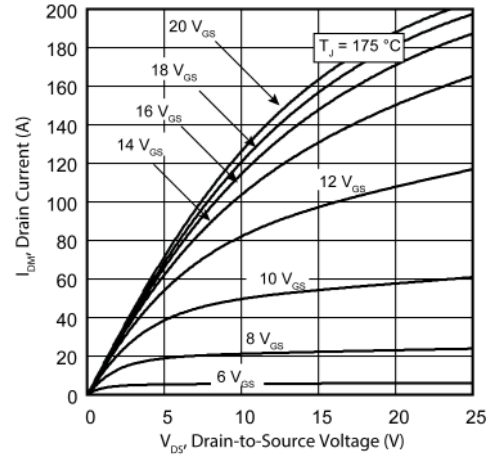

Figure 4 • Drain Current vs. V_{DS}

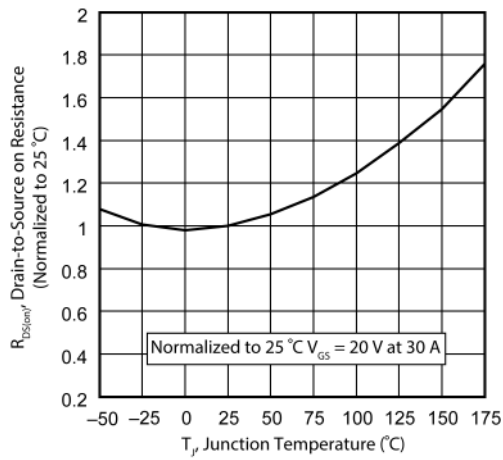

Figure 5 • $R_{DS(on)}$ vs. Junction Temperature

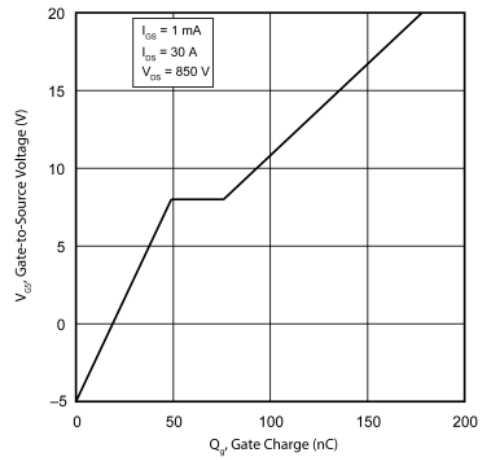

Figure 6 • Gate Charge Characteristics

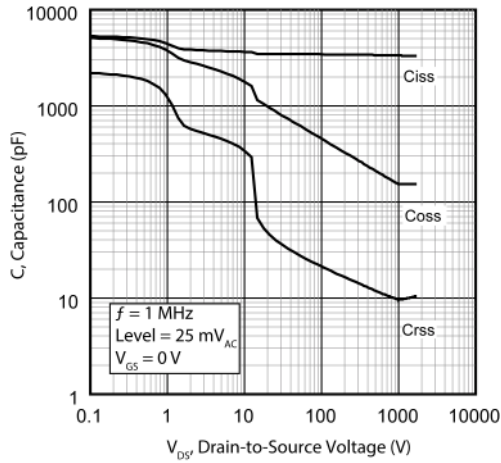

Figure 7 • Capacitance vs. Drain-to-Source Voltage

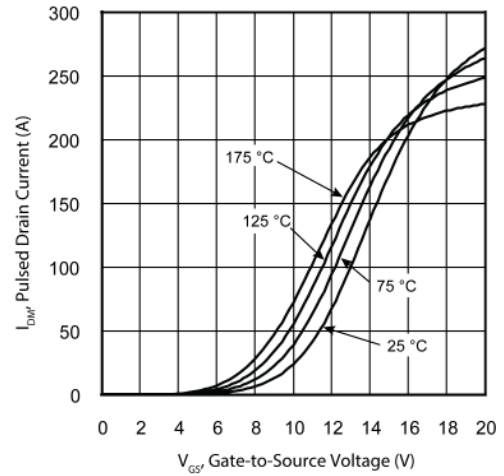

Figure 8 • I_{DM} vs. Gate-to-Source Voltage

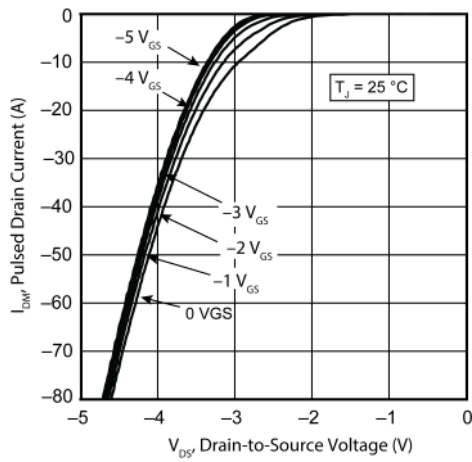

Figure 9 • I_{DM} vs. V_{DS} 3rd Quadrant Conduction

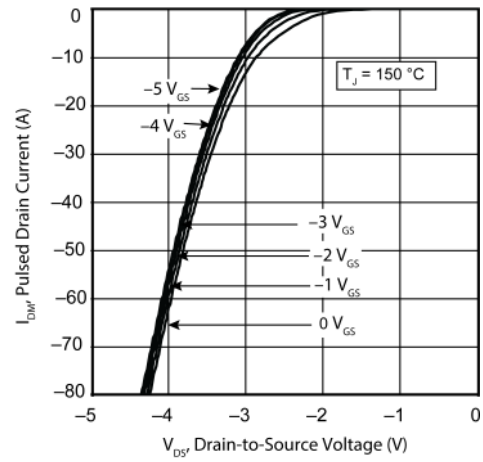

Figure 10 • I_{DM} vs. V_{DS} 3rd Quadrant Conduction

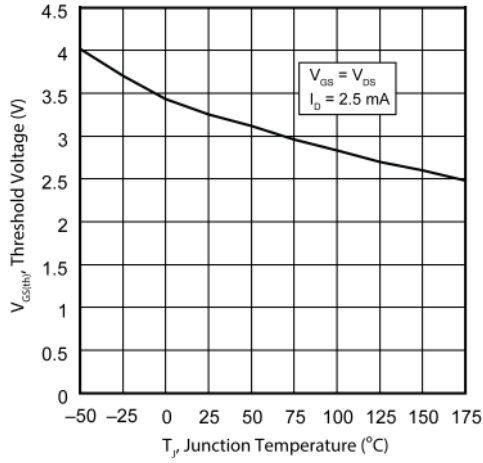

Figure 11 • Threshold Voltage vs. Junction Temp.

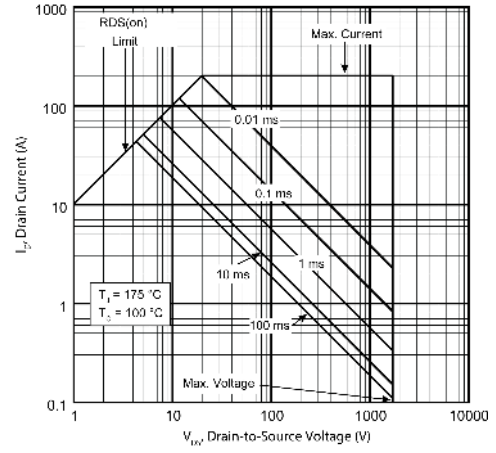

Figure 12 • Forward Safe Operating Area

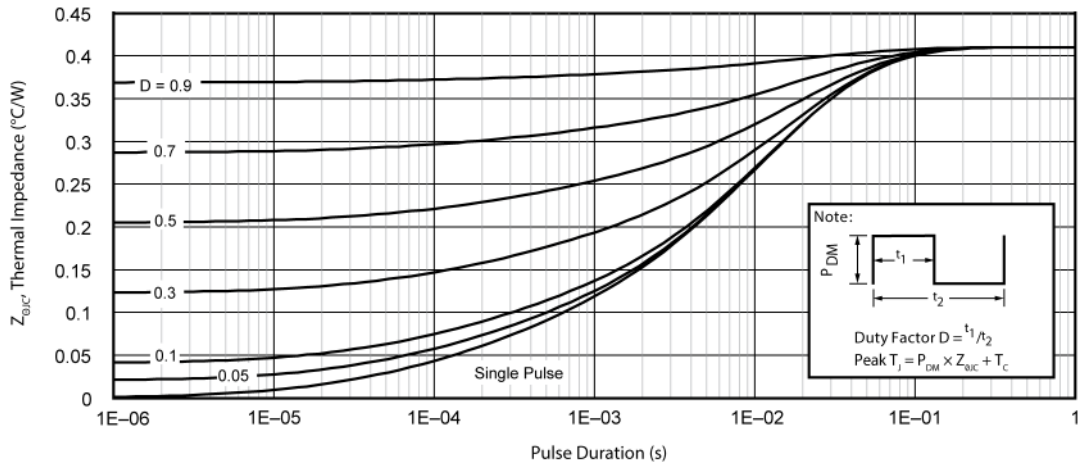

Figure 13 • Maximum Transient Thermal Impedance

Package Specification

This section shows the package specification of the MSC035SMA170B device.

Package Outline Drawing

The following figure illustrates the TO-247 package drawing for the MSC035SMA170B device. The dimensions in the figure below are in millimeters and (inches).

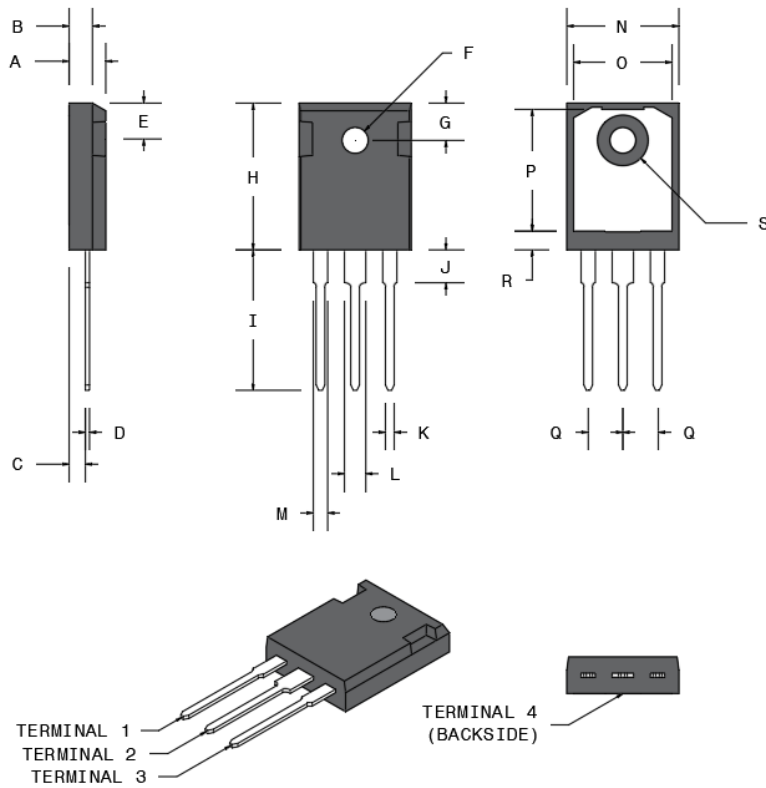

Figure 14 • Package Outline Drawing

The following table shows the MSC040SMA120B dimensions and should be used in conjunction with the package outline drawing.

Table 6 • TO-247 Dimensions

Symbol	Min (mm)	Max (mm)	Min (in.)	Max (in.)
A	4.69	5.31	0.185	0.209
B	1.49	2.49	0.059	0.098
C	2.21	2.59	0.087	0.102
D	0.40	0.79	0.016	0.031
E	5.38	6.20	0.212	0.244

Symbol	Min (mm)	Max (mm)	Min (in.)	Max (in.)
F	3.50	3.81	0.138	0.150
G	6.15 BSC		0.242 BSC	
H	20.80	21.46	0.819	0.845
I	19.81	20.32	0.780	0.800
J	4.00	4.50	0.157	0.177
K	1.01	1.40	0.040	0.055
L	2.87	3.12	0.113	0.123
M	1.65	2.13	0.065	0.084
N	15.49	16.26	0.610	0.640
O	13.50	14.50	0.531	0.571
P	16.50	17.50	0.650	0.689
Q	5.45 BSC		0.215 BSC	
R	2.00	2.75	0.079	0.108
S	7.10	7.50	0.280	0.295
Terminal 1	Gate			
Terminal 2	Drain			
Terminal 3	Source			
Terminal 4	Drain			

**Microsemi**

2355 W. Chandler Blvd.
 Chandler, AZ 85224 USA

Within the USA: +1 (480) 792-7200
 Fax: +1 (480) 792-7277

www.microsemi.com © 2020 Microsemi and its corporate affiliates. All rights reserved. Microsemi and the Microsemi logo are trademarks of Microsemi Corporation and its corporate affiliates. All other trademarks and service marks are the property of their respective owners.

Microsemi's product warranty is set forth in Microsemi's Sales Order Terms and Conditions. Information contained in this publication is provided for the sole purpose of designing with and using Microsemi products. Information regarding device applications and the like is provided only for your convenience and may be superseded by updates. Buyer shall not rely on any data and performance specifications or parameters provided by Microsemi. It is your responsibility to ensure that your application meets with your specifications. THIS INFORMATION IS PROVIDED "AS IS." MICROSEMI MAKES NO REPRESENTATIONS OR WARRANTIES OF ANY KIND WHETHER EXPRESS OR IMPLIED, WRITTEN OR ORAL, STATUTORY OR OTHERWISE, RELATED TO THE INFORMATION, INCLUDING BUT NOT LIMITED TO ITS CONDITION, QUALITY, PERFORMANCE, NON-INFRINGEMENT, MERCHANTABILITY OR FITNESS FOR A PARTICULAR PURPOSE. IN NO EVENT WILL MICROSEMI BE LIABLE FOR ANY INDIRECT, SPECIAL, PUNITIVE, INCIDENTAL OR CONSEQUENTIAL LOSS, DAMAGE, COST OR EXPENSE WHATSOEVER RELATED TO THIS INFORMATION OR ITS USE, HOWEVER CAUSED, EVEN IF MICROSEMI HAS BEEN ADVISED OF THE POSSIBILITY OR THE DAMAGES ARE FORESEEABLE. TO THE FULLEST EXTENT ALLOWED BY LAW, MICROSEMI'S TOTAL LIABILITY ON ALL CLAIMS IN RELATED TO THIS INFORMATION OR ITS USE WILL NOT EXCEED THE AMOUNT OF FEES, IF ANY, YOU PAID DIRECTLY TO MICROSEMI FOR THIS INFORMATION. Use of Microsemi devices in life support, mission-critical equipment or applications, and/or safety applications is entirely at the buyer's risk, and the buyer agrees to defend and indemnify Microsemi from any and all damages, claims, suits, or expenses resulting from such use. No licenses are conveyed, implicitly or otherwise, under any Microsemi intellectual property rights unless otherwise stated.

Microsemi Corporation, a subsidiary of Microchip Technology Inc. (Nasdaq: MCHP), and its corporate affiliates are leading providers of smart, connected and secure embedded control solutions. Their easy-to-use development tools and comprehensive product portfolio enable customers to create optimal designs which reduce risk while lowering total system cost and time to market. These solutions serve more than 120,000 customers across the industrial, automotive, consumer, aerospace and defense, communications and computing markets. Headquartered in Chandler, Arizona, the company offers outstanding technical support along with dependable delivery and quality. Learn more at www.microsemi.com.

050-7769 | March 2020 | Released