

DESCRIPTION

The EVM38222-R-01A Evaluation Board is designed to demonstrate the capabilities of MPS' MPM38222. The MPM38222 is a Dual Channels DC-DC Module. The module includes monolithic step-down switch mode converter with built-in internal power MOSFETs and inductors. It's designed to simplify power system design and provide ease of use.

The MPM38222 operates from a 2.7V-to-6V input, generates an output voltage as low as 0.608V, and has a 45µA quiescent current that makes it ideal for powering portable equipment that runs on a single cell lithium-ion (Li+) battery.

ELECTRICAL SPECIFICATION

Parameter	Symbol	Value	Units
Input Voltage	V_{IN}	2.7 – 6	V
Output Voltage	V_{OUT1}/V_{OUT2}	1.8/1.2	V
Output Current	I_{OUT1}/I_{OUT2}	2/2	A

FEATURES

- Dual 2A-Output Current
- >93% Peak Efficiency
- >80% Light-Load Efficiency
- Ultra Low IQ: 45µA
- 80mΩ and 35mΩ Internal Power MOSFET
- Wide 2.7V to 6V Operating Input Range
- Default 1MHz Switching Frequency
- 180° Phase-Shifted Operation
- 4mmx4mmx1.6mm QFN14 package
- 100% Duty Cycle Operation
- Cycle-by-Cycle Over-Current Protection
- Short Circuit Protection with Hiccup Mode
- Thermal Shutdown

APPLICATIONS

- Small/Handhold Devices
- DVD Drivers
- Portable Instruments
- Smart Phones and Feature Phones
- Battery-Powered Devices

All MPS parts are lead-free, halogen-free, and adhere to the RoHS directive. For MPS green status, please visit the MPS website under Quality Assurance. "MPS", the MPS logo, and "Simple, Easy Solutions" are trademarks of Monolithic Power Systems, Inc. or its subsidiaries.

EVM38222-R-01A EVALUATION BOARD

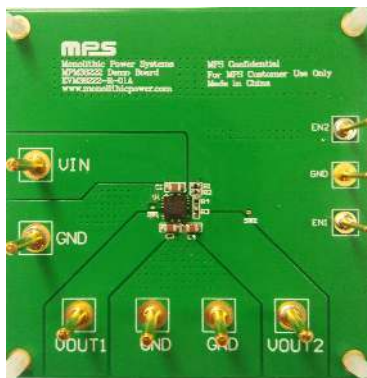

(L x W x H) 6.5cm x 6.5cm x 1.6cm

Board Number	MPS IC Number
EVM38222-R-01A	MPM38222

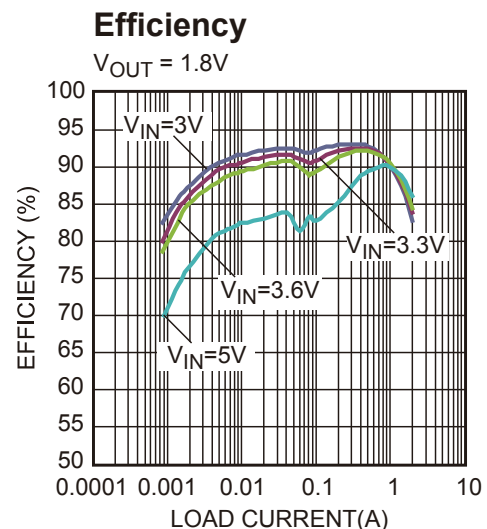

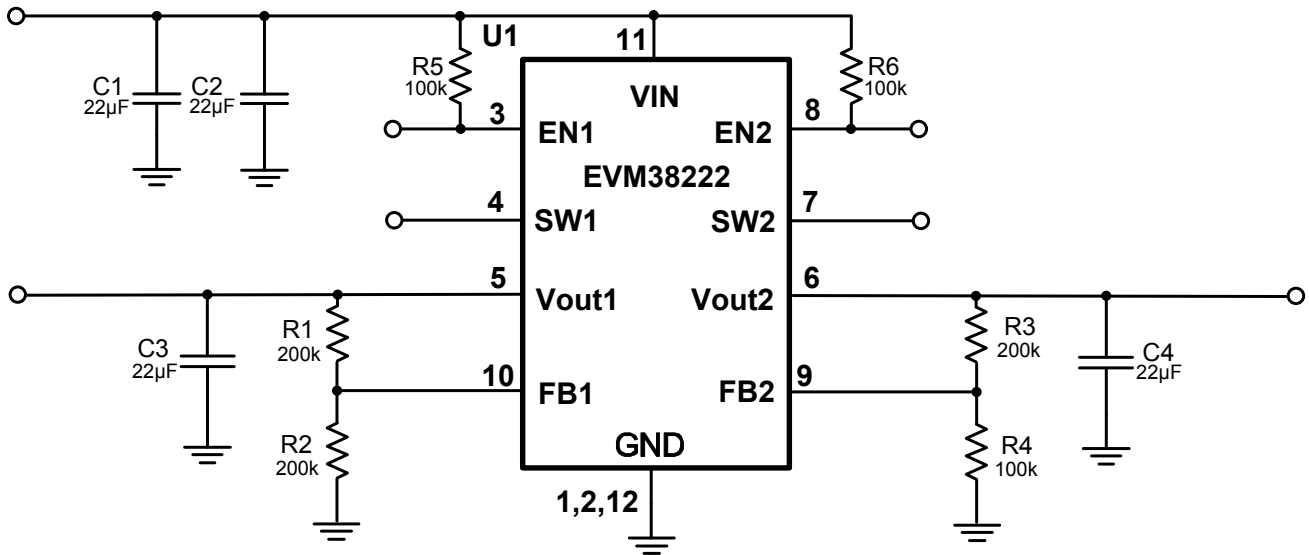
EVALUATION BOARD SCHEMATIC

EVM38222-R-01A BILL OF MATERIALS

Qty	Ref	Value	Description	Package	Manufacturer	Part Number
3	R1, R3, R2	200kΩ	Film Res,1%	0603	ROYAL	RL0603FR-07200KL
3	R4, R5, R6	100kΩ	Film Res,1%	0603	ROYAL	RL0603FR-07100KL
4	C1, C2, C3, C4	22µF	Ceramic Cap,10V, X5R	0805	muRata	GRM21BR61A226ME51L
1	U1	MPM38222	Dual Channel Step Down Switcher	QFN-14 4.0x4.0mm	MPS	MPM38222GR

EVB TEST RESULTS

Performance waveforms are tested on the evaluation board.

$V_{IN} = 5V$, $V_{OUT1} = 1.8V$, $V_{OUT2} = 1.2V$, $C_{OUT1} = C_{OUT2} = 22\mu F$, $T_A = 25^\circ C$, unless otherwise noted.

Output Ripple
 $I_{OUT1} = I_{OUT2} = 0A$

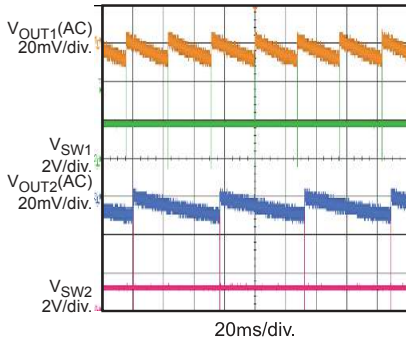

Output Ripple
 $I_{OUT1} = I_{OUT2} = 1A$

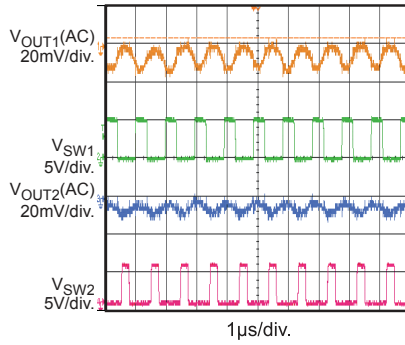

Output Ripple
 $I_{OUT1} = I_{OUT2} = 2A$

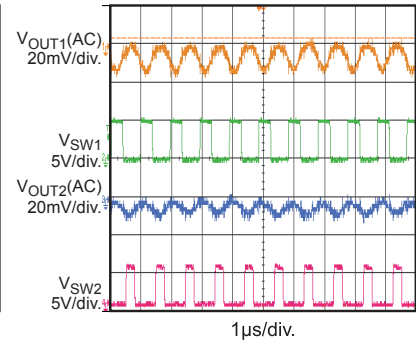

V_{IN} Power Up without Load
 $I_{OUT1} = I_{OUT2} = 0A$

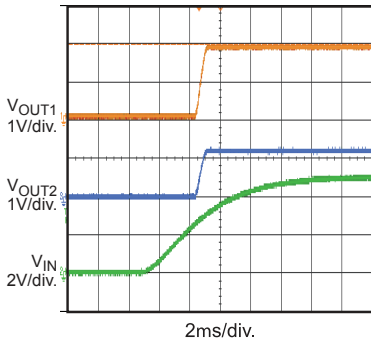

V_{IN} Power Up with 1A Load
 $I_{OUT1} = I_{OUT2} = 1A$

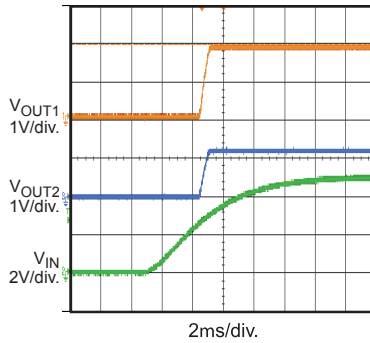

V_{IN} Power Up with 2A Load
 $I_{OUT1} = I_{OUT2} = 2A$

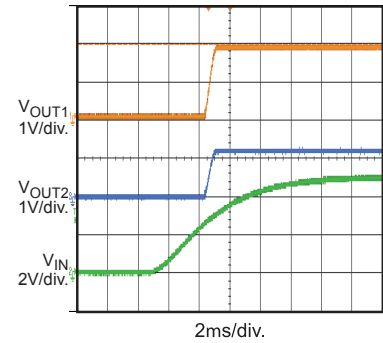

V_{IN} Power Down without Load
 $I_{OUT1} = I_{OUT2} = 0A$

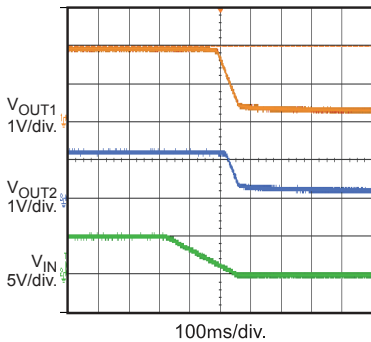

V_{IN} Power Down with 1A Load
 $I_{OUT1} = I_{OUT2} = 1A$

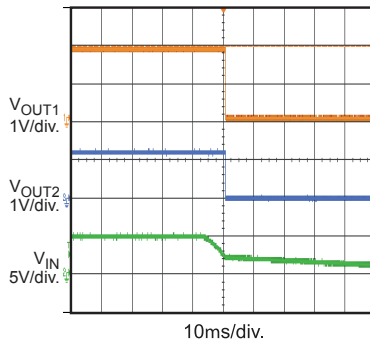

V_{IN} Power Down with 2A Load
 $I_{OUT1} = I_{OUT2} = 2A$

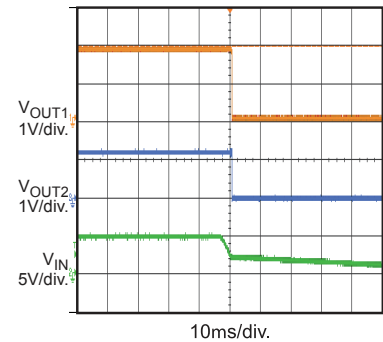

EVB TEST RESULTS (continued)

Performance waveforms are tested on the evaluation board.

$V_{IN} = 5V$, $V_{OUT1} = 1.8V$, $V_{OUT2} = 1.2V$, $C_{OUT1} = C_{OUT2} = 22\mu F$, $T_A = 25^\circ C$, unless otherwise noted.

EN On without Load
 $I_{OUT1} = I_{OUT2} = 0A$

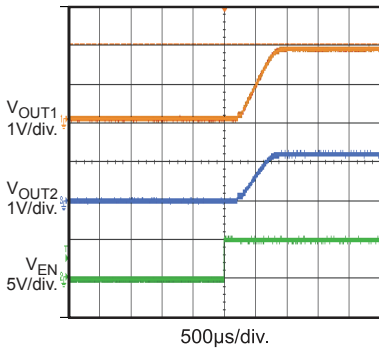

EN On with 1A Load
 $I_{OUT1} = I_{OUT2} = 1A$

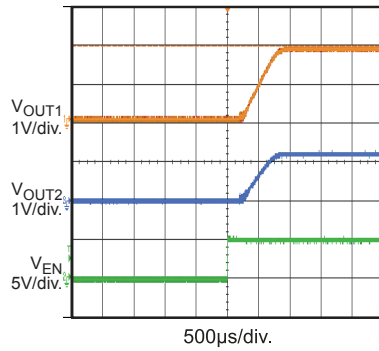

EN On with 2A Load
 $I_{OUT1} = I_{OUT2} = 2A$

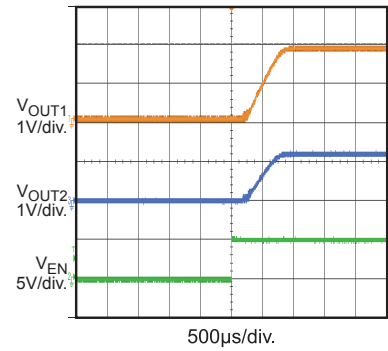

EN Down without Load
 $I_{OUT1} = I_{OUT2} = 0A$

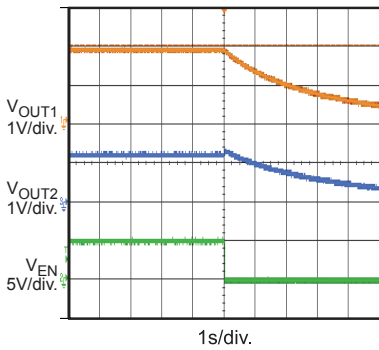

EN Down with 1A Load
 $I_{OUT1} = I_{OUT2} = 1A$

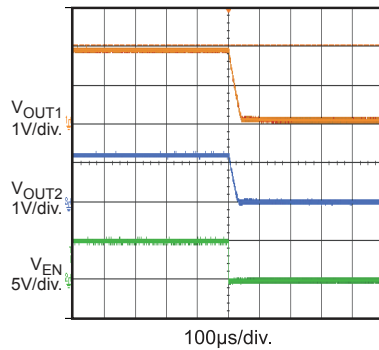

EN Down with 2A Load
 $I_{OUT1} = I_{OUT2} = 2A$

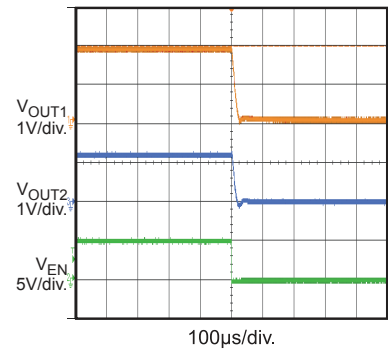

VIN Power On without Load
 $I_{OUT1} = I_{OUT2} = 0A$

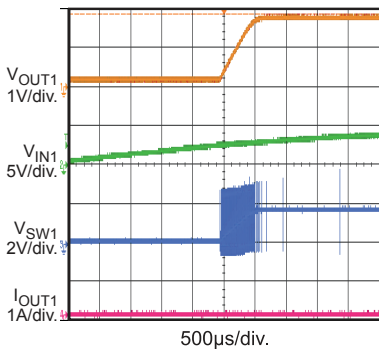

VIN Power On with 1A Load
 $I_{OUT1} = 1A, I_{OUT2} = 0A$

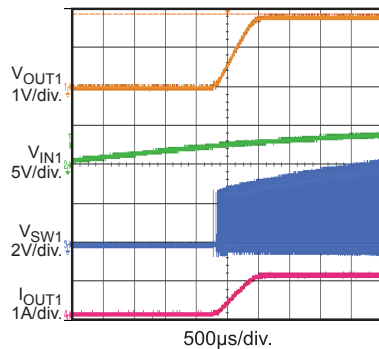

VIN Power On with 2A Load
 $I_{OUT1} = 2A, I_{OUT2} = 0A$

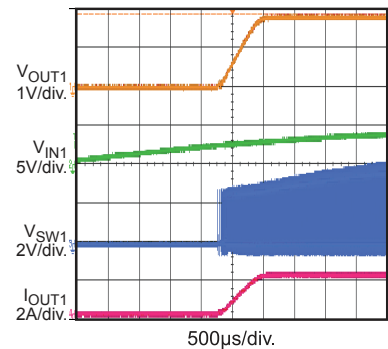

EVB TEST RESULTS (continued)

Performance waveforms are tested on the evaluation board.

 $V_{IN} = 5V$, $V_{OUT1} = 1.8V$, $V_{OUT2} = 1.2V$, $C_{OUT1} = C_{OUT2} = 22\mu F$, $T_A = 25^\circ C$, unless otherwise noted.

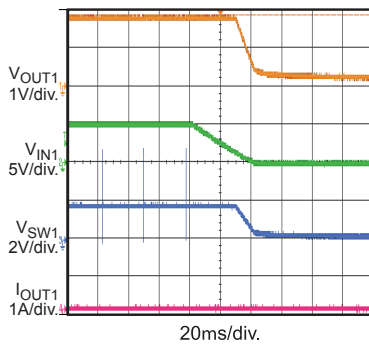
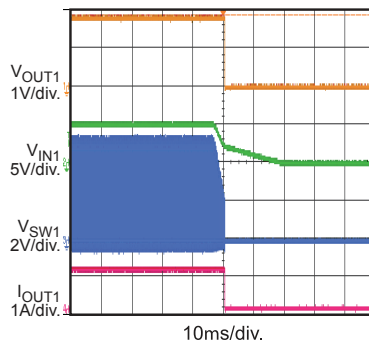
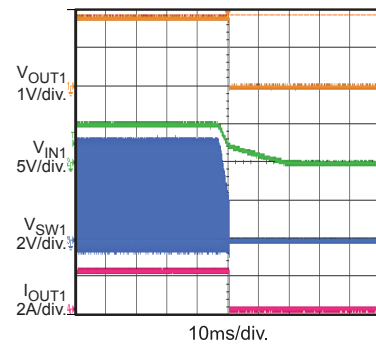
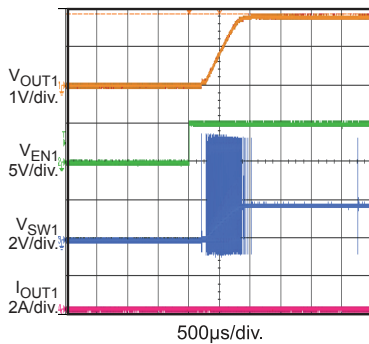
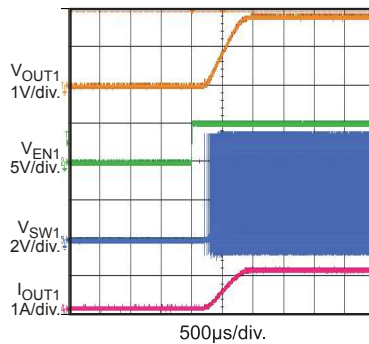
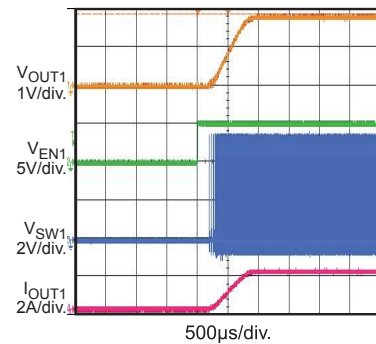
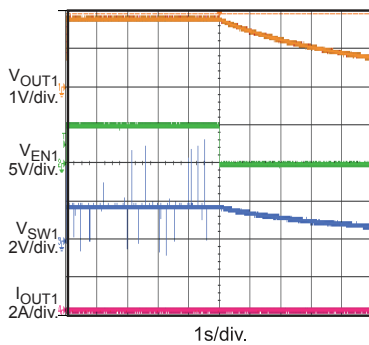
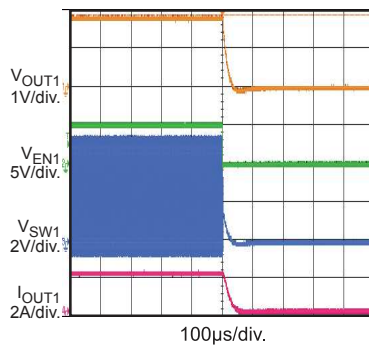
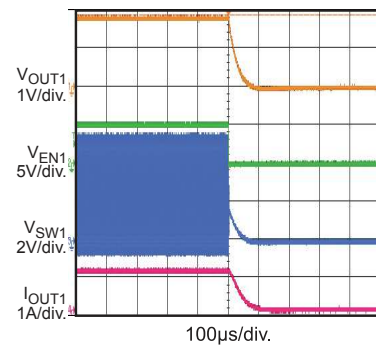
 **V_{IN} Power Down
without Load**
 $I_{OUT1} = I_{OUT2} = 0A$

 **V_{IN} Power Down
with 1A Load**
 $I_{OUT1} = 1A$, $I_{OUT2} = 0A$

 **V_{IN} Power Down
with 2A Load**
 $I_{OUT1} = 2A$, $I_{OUT2} = 0A$

Enable On without Load
 $I_{OUT1} = I_{OUT2} = 0A$

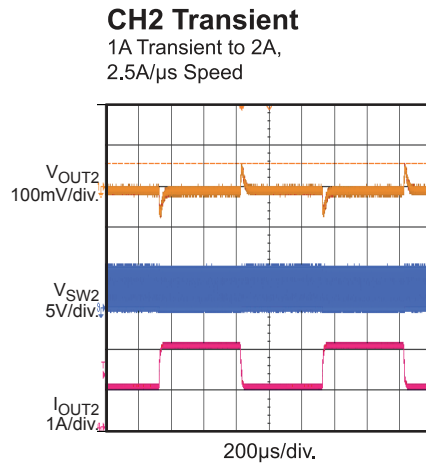
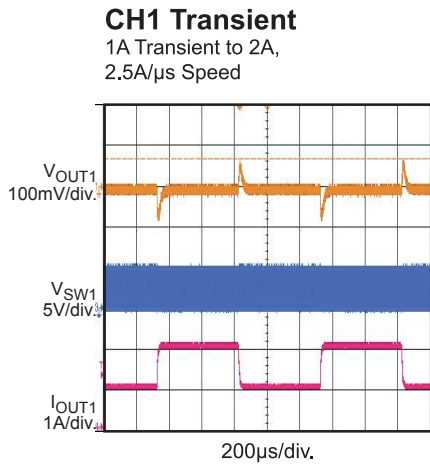
Enable On with 1A Load
 $I_{OUT1} = 1A$, $I_{OUT2} = 0A$

Enable On with 2A Load
 $I_{OUT1} = 2A$, $I_{OUT2} = 0A$

Enable Down without Load
 $I_{OUT1} = I_{OUT2} = 0A$

Enable Down with 1A Load
 $I_{OUT1} = 1A$, $I_{OUT2} = 0A$

Enable Down with 2A Load
 $I_{OUT1} = 2A$, $I_{OUT2} = 0A$

EVB TEST RESULTS *(continued)*

Performance waveforms are tested on the evaluation board.

$V_{IN} = 5V$, $V_{OUT1} = 1.8V$, $V_{OUT2} = 1.2V$, $C_{OUT1} = C_{OUT2} = 22\mu F$, $T_A = 25^\circ C$, unless otherwise noted.



PRINTED CIRCUIT BOARD LAYOUT

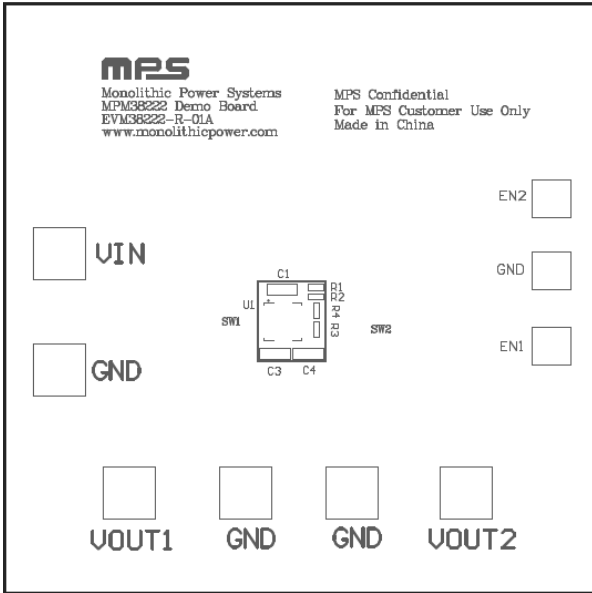

Figure 1: Top Silk Layer

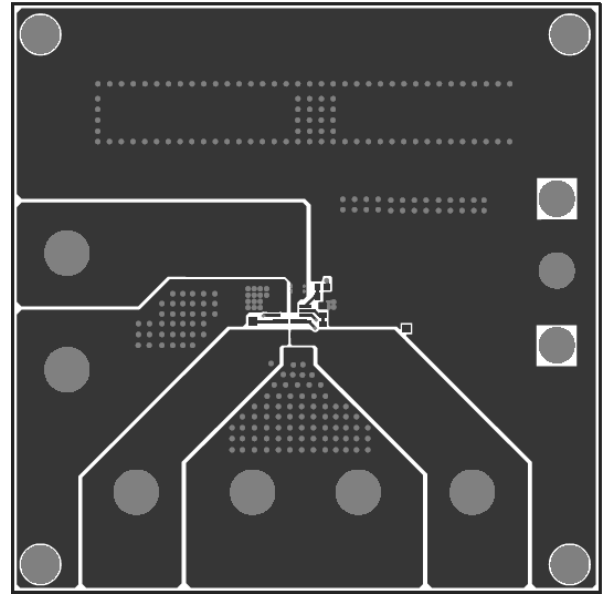

Figure 2: Top Layer

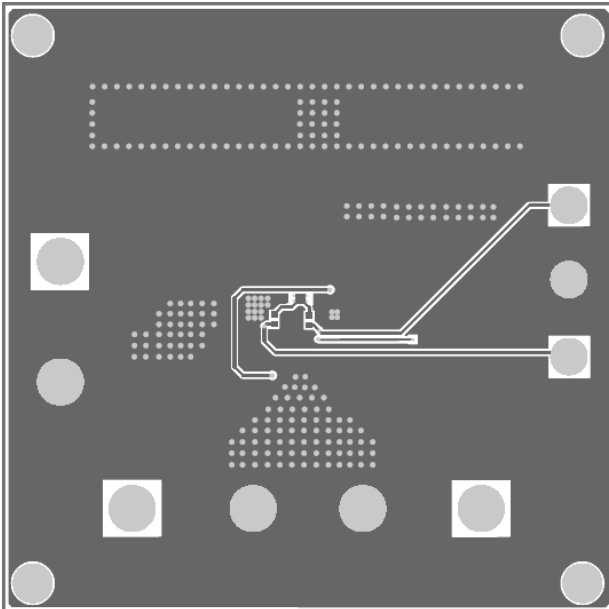

Figure 3: Bottom Layer

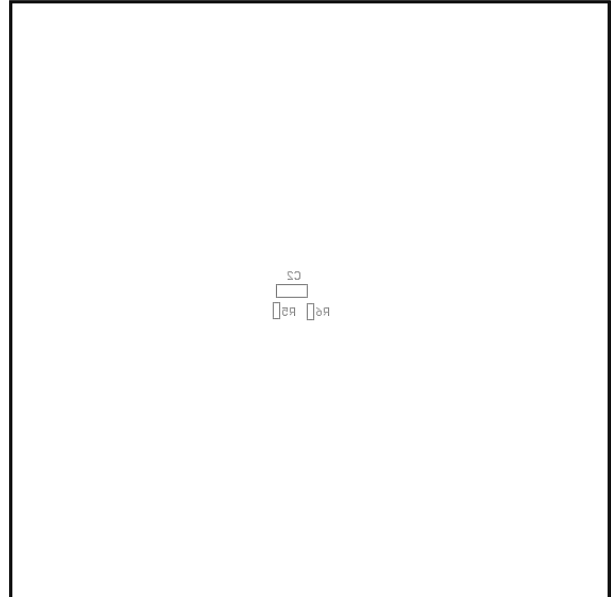

Figure 4: Bottom Silk Layer

QUICK START GUIDE

The output voltage of this board is set externally by operating from +2.7V to +6V input. The default output voltage of this board is set to $V_{OUT1}=1.8V$, $V_{OUT2}=1.2V$.

1. Preset Power Supply to $2.7V \leq V_{IN} \leq 6V$.
2. Turn Power Supply off.
3. Connect Power Supply terminals to:
 - a. Positive (+): V_{IN}
 - b. Negative (-): GND
4. Connect Load to:
 - a. Positive (+): V_{OUT1}
 - b. Negative (-): GND
 - c. Positive (+): V_{OUT2}
 - d. Negative (-): GND
5. Turn Power Supply on after making connections.
6. To enable the MPM38222, apply a voltage, $1.2V \leq V_{EN} \leq 6V$, to the EN pin. To disable the MPM38222, apply a voltage, $V_{EN} < 0.4V$, to the EN pin. The EN pin can be connected to V_{IN} with a 100k Ω resistor for automatic startup.
7. The output voltage V_{OUT} can be changed by varying R1. Calculate the new value by formula:

$$R2 = \frac{R1}{\frac{V_{OUT}}{0.608V} - 1}$$

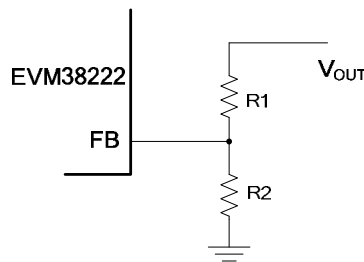

Figure 5

NOTICE: The information in this document is subject to change without notice. Please contact MPS for current specifications. Users should warrant and guarantee that third party Intellectual Property rights are not infringed upon when integrating MPS products into any application. MPS will not assume any legal responsibility for any said applications.