

PRODUCT NUMBER

51720-ABBCCDDEF..

SEE NOTE 1

SEE DETAIL A SEE DETAIL B

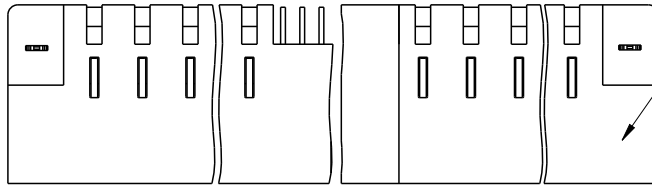
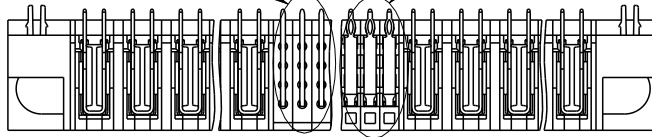

SEE NOTE 9

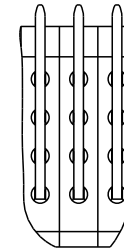

DETAIL A
SCALE 2:1
FOR SOLDER TO BOARD ONLY

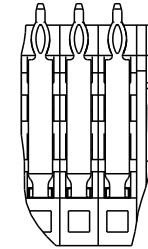

DETAIL B
SCALE 2:1
FOR PRESS FIT ONLY

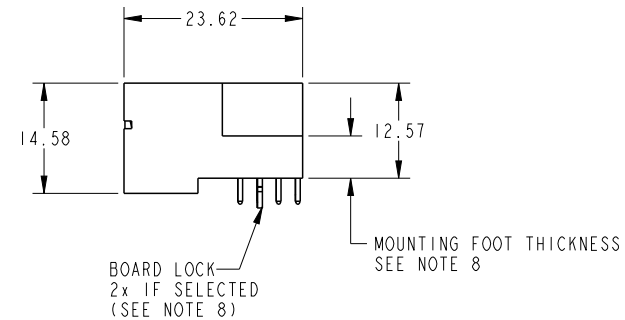
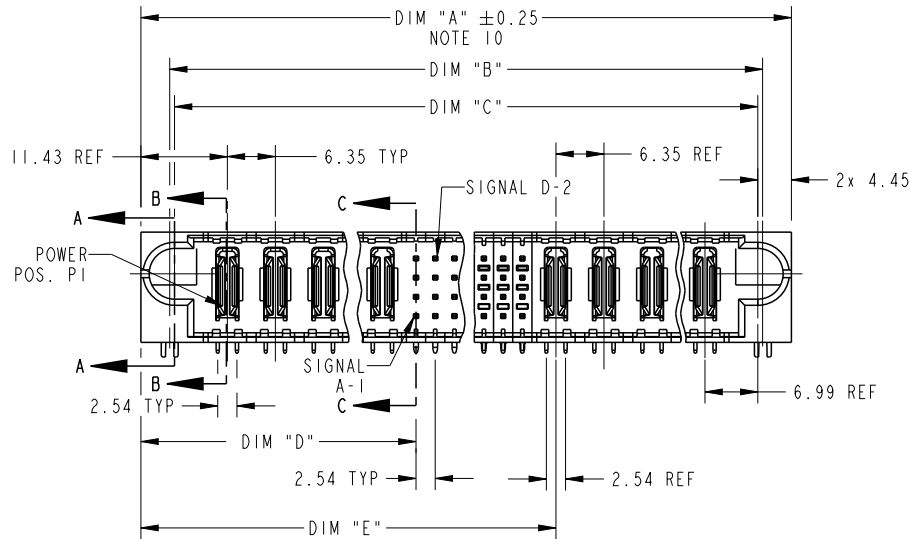

Copyright FCI.

spec ref	*	dr	w wcadmin	2006/11/08	projection	MM	size	A4	scale	1:1	
tolerance std	ASME Y14.5	eng	Ruan MT	2015/09/29			←→	ecn no	ELX-DG-21593-1		
TOLERANCES UNLESS OTHERWISE SPECIFIED		chr	Fancy Zhang	2015/09/30		product family		PwrBlade	rel level	Released	
surface	✓	appr	Pei-Ming Zheng	2015/09/30	www.fci.com		title	R/A HEADER WITH GUIDE PIN		rev	
ASME Y14.5	linear	0.X	±0.5		title	POWER / SIGNAL / POWER		dwg no	51720		
		0.XX	±0.25		cat. no.	51720	Product - Customer Drw		sheet	1 of 3	
	angular	0°	±2°								

PRODUCT NUMBER	DIM	LENGTH FORMULAS (SEE NOTE 10)
51720-ABBCCDDEF..	DIM "A"	6.35 x BB + 2.54 x (CCC/4) + 6.35 x DD + 16.51(NOTE 10)
SEE NOTE 1	DIM "B"	6.35 x BB + 2.54 x (CCC/4) + 6.35 x DD + 8.89
	DIM "C"	6.35 x BB + 2.54 x (CCC/4) + 6.35 x DD + 7.62
	DIM "D"	6.35 x BB + 9.53
	DIM "E"	6.35 x BB + 2.54 x (CCC/4) + 11.43
	DIM "F"	6.35 x BB + 2.54 x (CCC/4) + 6.35 x DD + 17.27
	DIM "G"	6.35 x BB + 5.72
	DIM "H"	6.35 x BB + 2.54 x (CCC/4) + 6.35

CONNECTOR NOTES

1. PRODUCT NUMBER CODE:
 51720 - A BB CCC DD E F LF
- NO THIS SUFFIX: 100u"/2.54um SnPb ON PCB INTERFACE
 - ADD THIS SUFFIX: 78u"/2.00um Sn OR 5u" Au ON PCB INTERFACE
 - RETENTION TO PCB (NOTE 8)
 - TAIL OPTIONS (NOTE 7)
 - NUMBER OF RIGHT END POWER CONTACTS (NOTE 6)
 - NUMBER OF SIGNAL CONTACTS (NOTE 5)
 - NUMBER OF LEFT END POWER CONTACTS (NOTE 4)
 - PLATING (NOTE 3)
 - BASE NUMBER

2. HOUSING MATERIAL: GLASS FILLED V-O HIGH TEMP THERMO PLASTIC.
 SIGNAL CONTACT MATERIAL: COPPER ALLOY
 POWER CONTACT MATERIAL: COPPER ALLOY
3. PLATING OPTION:
 I = SEE ITEM PRINT 10064183 FOR PLATING SPEC OF 51720-ABBCCDDEF; 51720-ABBCCDDEF LF

4. LEFT END POWER CONTACTS, 01 TO 19 AVAILABLE.
 MAXIMUM OF 20 POWER CONTACTS PER CONNECTOR.
5. SIGNAL CONTACTS, 004 TO 148 AVAILABLE.
6. RIGHT END POWER CONTACTS, 01 TO 19 AVAILABLE.
 MAXIMUM OF 20 POWER CONTACTS PER CONNECTOR.



7. TAIL OPTIONS:
 A = 3.43 SOLDER TO BOARD
 B = 4.19 SOLDER TO BOARD
 C = 3.43 PRESS FIT
 D = 2.34 SOLDER TO BOARD

8. RETENTION TO PCB OPTIONS:
 A = BOARD LOCK (2.49 +0.05, -0.03 THRU HOLE IN PCB).
 MOUNTING FOOT THICKNESS: 5.59
 B = 3.81 THRU HOLE (REQUIRES 4.01±0.07 THRU HOLE IN PCB).
 MOUNTING FOOT THICKNESS: 4.06
 MOUNTING HOLES, WHERE APPLICABLE, ARE UNPLATED.
9. MANUFACTURE'S NAME, P/N, AND DATE CODE TO APPEAR ON THIS SURFACE.
10. THE MAXIMUM OVERALL LENGTH (DIM A) OF A PART IS 203.2
11. PRODUCT SPECIFICATION GS-12-149
 APPLICATION SPECIFICATION BUS-20-067
12. REFERENCE 51697 FOR SELECT LOAD/FMLB WORKSHEET.

- PCB NOTES:
13. ALL DIMENSIONS ARE BASIC UNLESS OTHERWISE SPECIFIED.
14. ALL THROUGH HOLES ARE LOCATED WITH A TRUE POSITION OF 0.10
15. ALL HOLE DIAMETERS ARE FINISHED HOLE SIZE.
16. Ø1.151±0.025 DRILLED HOLES PLATED WITH 0.008 MIN SnPb or Sn OVER 0.03 TO 0.08 PLATING TO ACHIEVE A 1.02±0.07 HOLE.
17. A  SYMBOL WILL BE NEXT TO ANY DIMENSION, VIEW, OR NOTE WHICH HAS BEEN MODIFIED WITH THE CURRENT DRAWING REVISION.
18. CONNECTOR KEEP OUT ZONE.

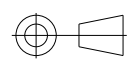
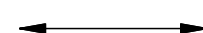

Copyright FCI.

dr	wcadmin	2006/11/08	projection 	MM 	size	A4	scale	1:1	
eng	Ruan MT	2015/09/29			ecn no	ELX-DG-21593-1			
chr	Fancy Zhang	2015/09/30			rel level	Released			
appr	Pei-Ming Zheng	2015/09/30	product family	PwrBlade		rev	S		
		title			R/A HEADER WITH GUIDE PIN		dwg no		51720
www.fci.com		cat. no.			51720		Product - Customer Drw		sheet 2 of 3

PRODUCT NUMBER

51720-ABBCCDDEF..

SEE NOTE 1

SIGNAL D
SIGNAL C
SIGNAL B
SIGNAL A

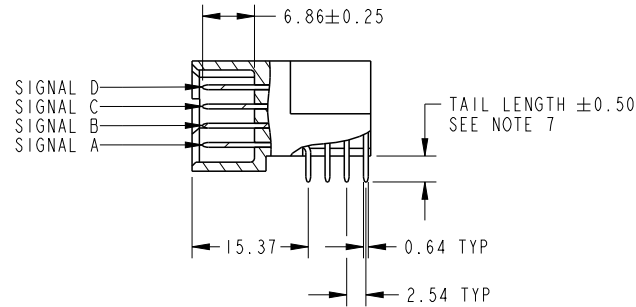

△ BROKEN-OUT SECTION C-C FOR SOLDER TO BOARD ONLY

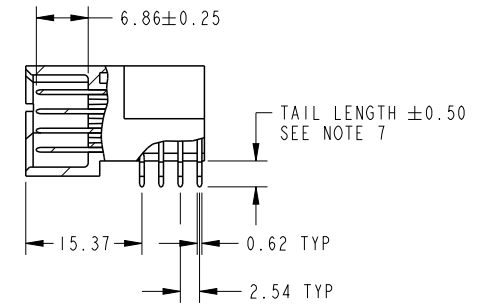

△ BROKEN-OUT SECTION C-C FOR PRESS FIT ONLY

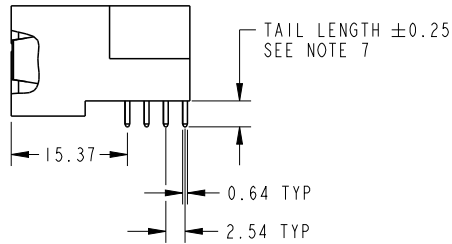

△ BROKEN-OUT SECTION B-B FOR SOLDER TO BOARD ONLY

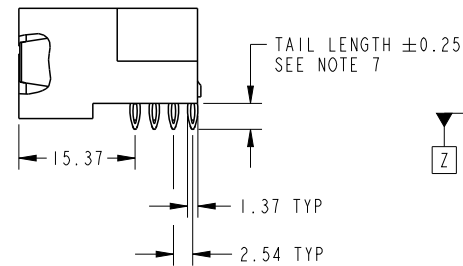

△ BROKEN-OUT SECTION B-B FOR PRESS FIT ONLY

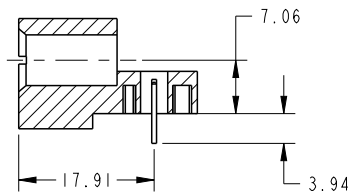

SECTION A-A

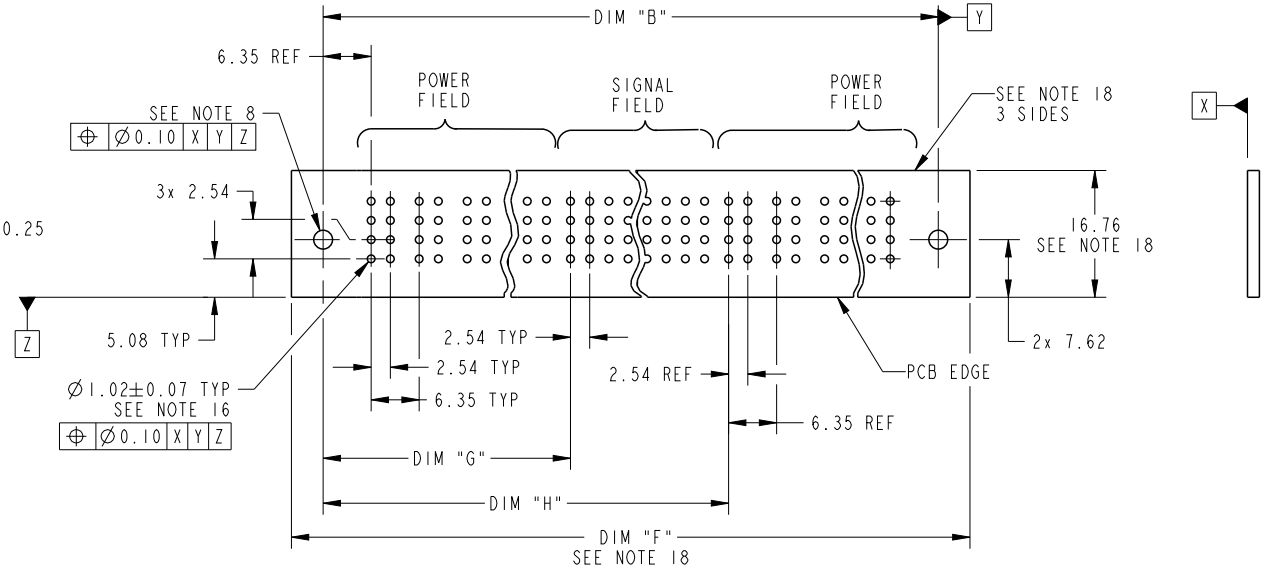

RECOMMENDED PCB LAYOUT

dr	w wcadmin	2006/11/08	projection	MM	size	A4	scale	1:1
eng	Ruan MT	2015/09/29			ecn no	ELX-DG-21593-1		
chr	Fancy Zhang	2015/09/30				rel level	Released	
appr	Pei-Ming Zheng	2015/09/30	product family	PwrBlade				
			title	R/A HEADER WITH GUIDE PIN		dwg no	51720	
			title	POWER / SIGNAL / POWER			rev	
www.fci.com			cat. no.	51720	Product - Customer Drw		sheet 3 of 3	

FCI
Copyright FCI.