

4

3

2

1

THIS DRAWING IS UNPUBLISHED. RELEASED FOR PUBLICATION, 19 .

© COPYRIGHT 19 BY AMP INCORPORATED. ALL RIGHTS RESERVED.

LOC	DIST	REVISIONS			
P	LTR	DESCRIPTION	DATE	DWN	APVD
G	14	E	REV PER 063A-0541-00	25SEP00	JR TM

1 WIRE INSULATION DIA IS 1.90-2.21
[.075-.087]

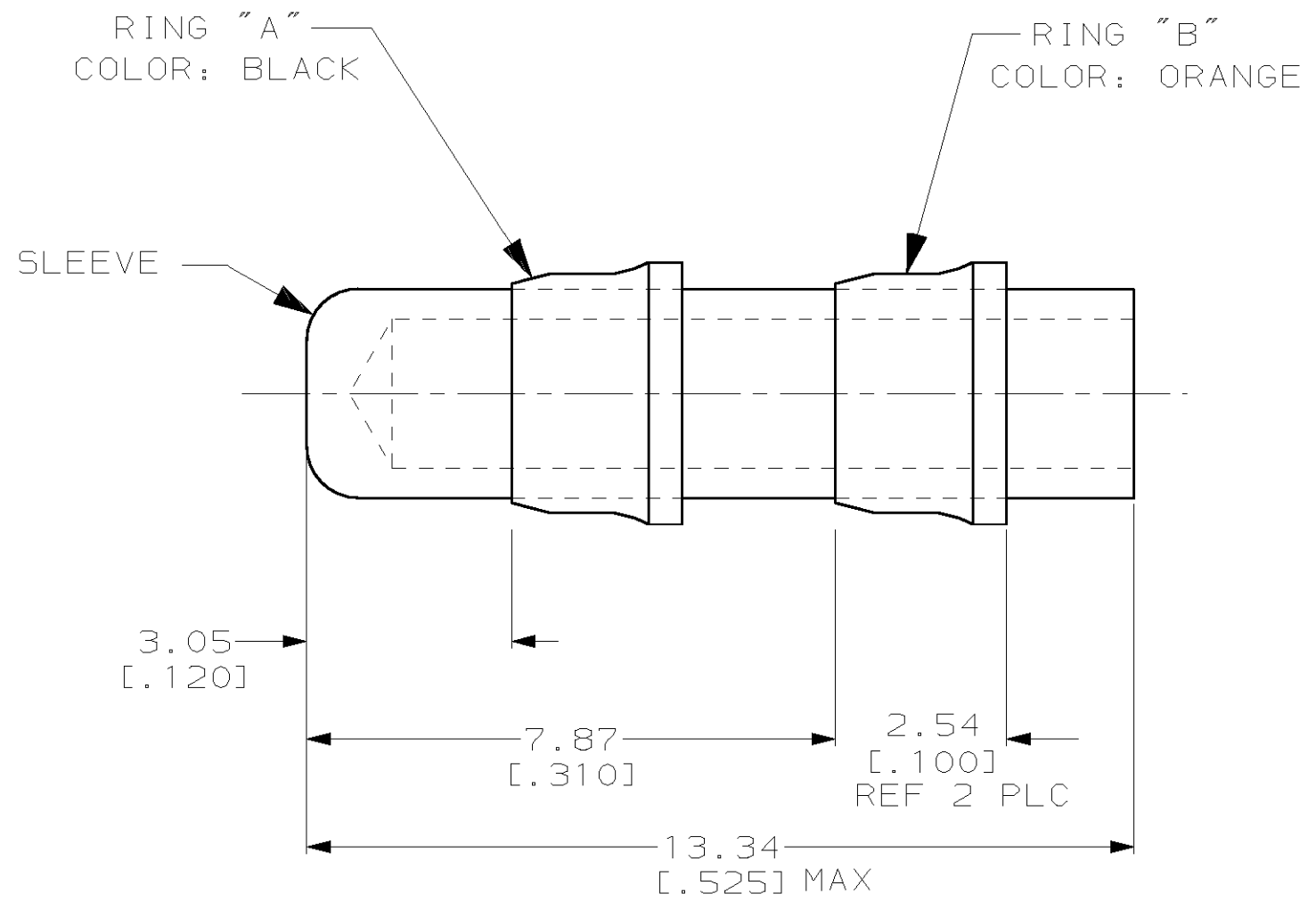

TEFLON ASTM D-1710		SLEEVE	
COPPER PER ASTM B152 / NICKEL PL PER QQ-N-290		RING "B"	
COPPER PER ASTM B152 / NICKEL PL PER QQ-N-290		RING "A"	
MATERIAL / FINISH		DESCRIPTION	
THIS DRAWING IS A CONTROLLED DOCUMENT.		DWN JR RUTH 31MAY00	AMP Incorporated Harrisburg, PA 17105-3608
DIMENSIONS: MM [INCHES]		CHK R HERSEY 31MAY00	
		APVD T MICHIELUTTI 31MAY00	
TOLERANCES UNLESS OTHERWISE SPECIFIED:		NAME	
0 PLC ±-		PRE-INSULATED SPARE WIRE CAP	
1 PLC ±-		PRODUCT SPEC	
2 PLC ±0.40 [.015]		APPLICATION SPEC	
3 PLC ±-		SIZE	
4 PLC ±-		CAGE CODE	
ANGLES ±-		DRAWING NO	
MATERIAL SEE TABLE		RESTRICTED TO	
FINISH SEE TABLE		A3 00779 C- 328859	
CUSTOMER DRAWING		SCALE 10:1 SHEET 1 OF 1 REV E	