

Approved	Checked	Designed	DEVELOPMENT SPECIFICATION					
T. Shoda	M. Mori	T. Tabata	P/N: LNJ316C8TRA					
T	Y	P	E	Green Light Emitting Diode				
APPLICATION			Indicators					
MATERIAL			GaP					
OUTLINE			Attached					
ABSOLUTE MAXIMUM RATINGS			P	*I _{FP}	I _{FDC}	V _R	Topr	Tstg
			60	100	20	4	-30~+85	-40~+100
			mW	mA	mA	V	°C	°C
CONDITION			T _a = 25 ± 3°C					
Test Specification								
I t e m	Symbol	C o n d i t i o n	Typ	Limit		Unit		
				Min	Max			
Forward Voltage	V _F	I _F = 10 mA	2.03		2.6	V		
Reverse Leakage Current	I _R	V _R = 4 V			10	μA		
Luminous Intensity	I _O	I _F = 10 mA DC	8.8	3.3		mcD		
Peak Emission Wavelength	λ _p	I _F = 10 mA DC	565			nm		
Spectral Line Half Width	Δλ	I _F = 10 mA DC	30			nm		
<p>* · The Condition of I_{FP} is duty 10 % , Pulse width 1 ms</p> <p>· Please contact the Panasonic local office if you design at low current (below 1 mA DC) or pulse current operation and have any questions.</p>								
<p>NOTE</p> <p>★1. Soldering conditions. Refer to Handling note.</p> <p>★2. Care should be taken that soldering is done within 3-days after opening the dry package and reel.</p> <p>★3. Compositions of the lead Cu/Ni/Au plating</p>								
Apr. 6. 1999								

Approved	Checked	Designed	DEVELOPMENT SPECIFICATION		
T. Akeda	M. Ichi	T. Tabata	P/N: LN316C8TRA		

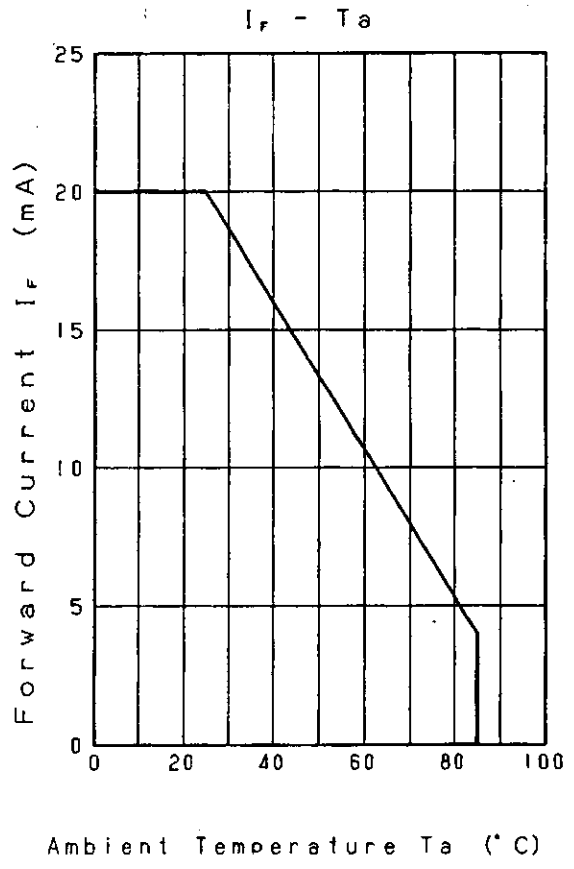
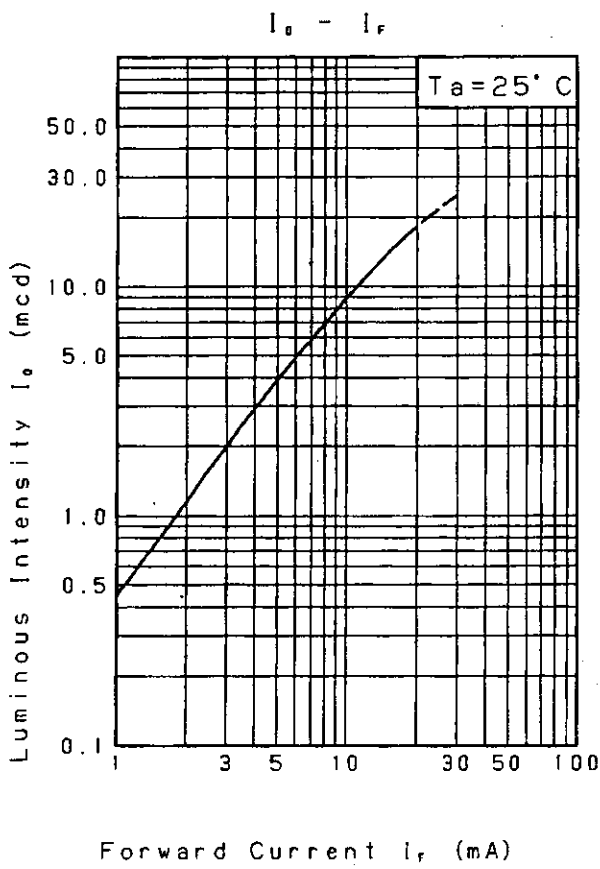
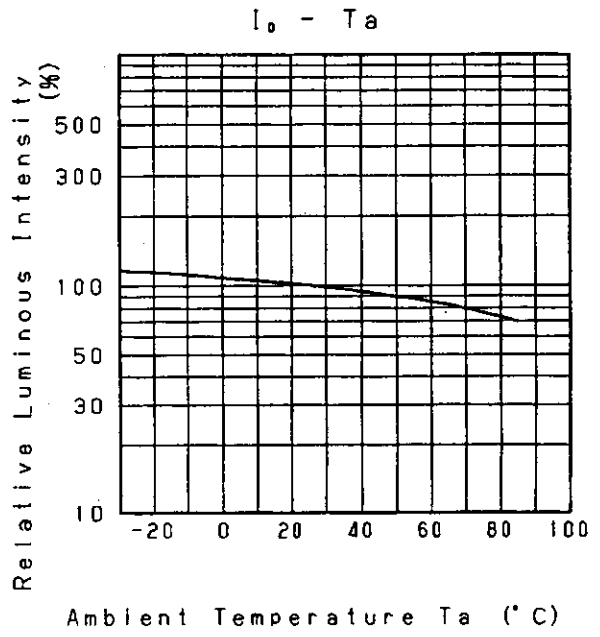
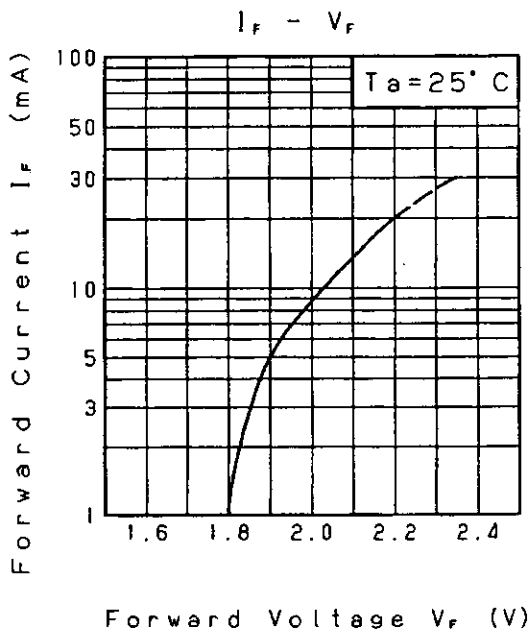

Apr. 6. 1999			
--------------	--	--	--

Approved	Checked	Designed	DEVELOPMENT SPECIFICATION				
T. Shoda	M. Ni	T. Taketa	P/N: LNJ316C8TRA				

Relative Luminous Intensity
Wavelength Characteristics

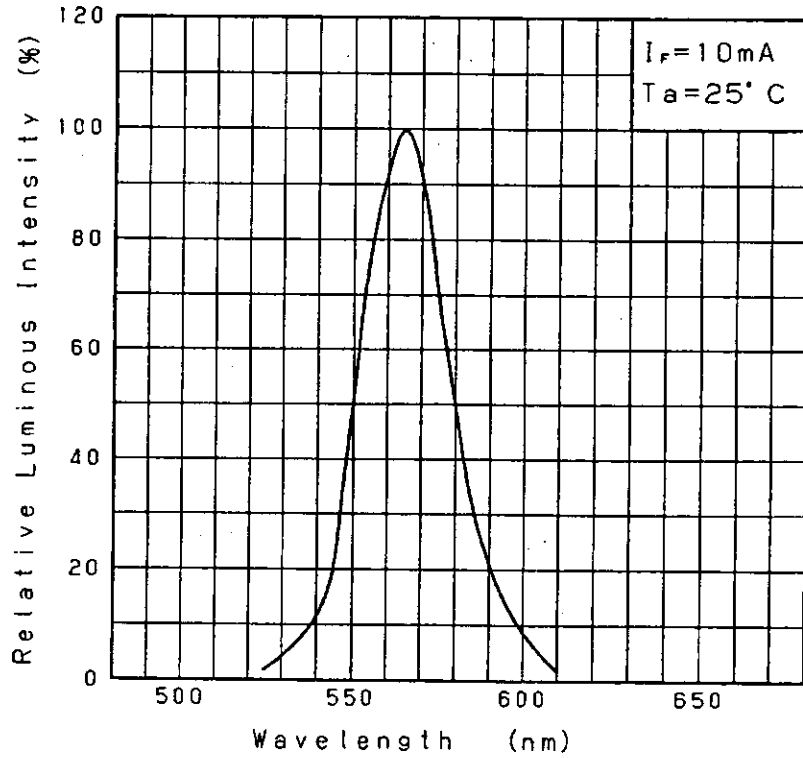

Directive Characteristics

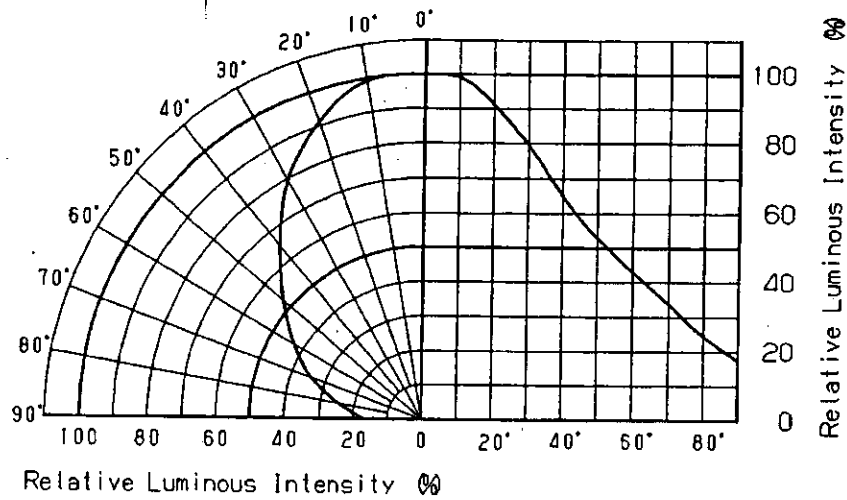

Apr. 6. 1999			

Approved	Checked	Designed	DEVELOPMENT SPECIFICATION (OUTLINE) P/N: LNJ316C8TRA		
<i>T. Shirota</i>	<i>M. Imai</i>	<i>T. Tabata</i>			

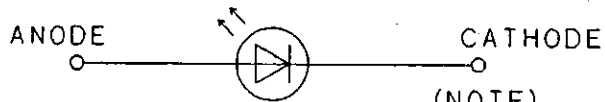
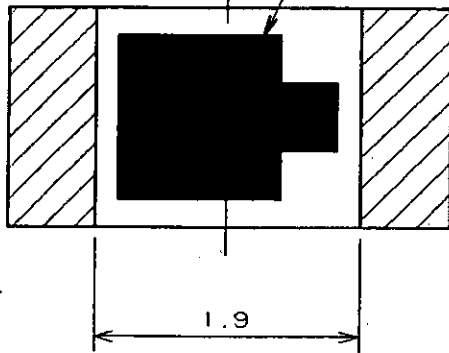
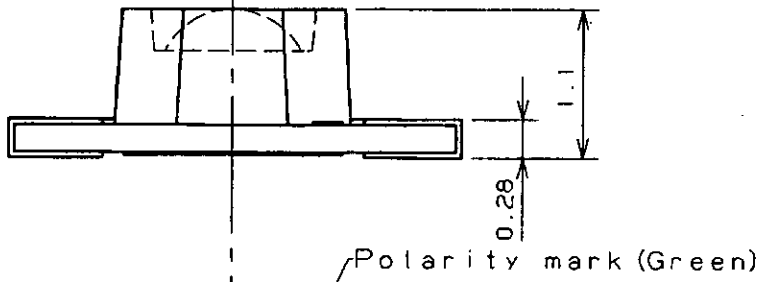
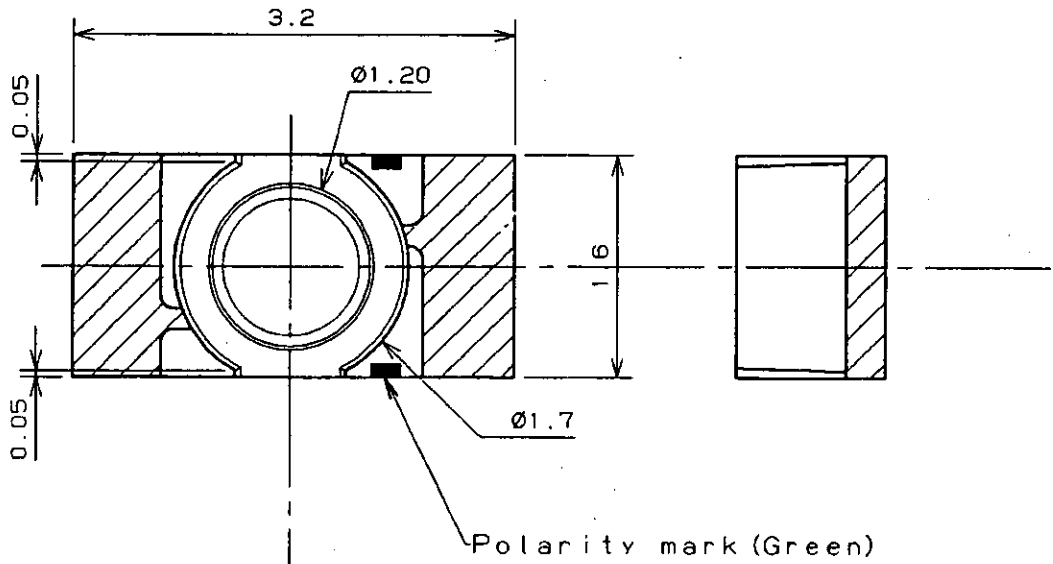

(NOTE)
 1. Unit: mm
 2. Tolerance unless specified is ± 0.15 .
 3. indicate Au terminal.

Nov. 12. 1999			