

Features

- On Chip Hall Sensor
- Rotor-Locked Shutdown
- Automatically Restart
- Rotor-State Detection (RD) Output
- Built-in Zener Protection for Output Driver
- Operating Voltage: 3.8V~28V
- Output Current: $I_{O(AVE)} = 400mA$
- Lead Free Package: SOT89-5L (Note 1)
- SOT89-5L: Available in "Green" Molding Compound (No Br, Sb)
- Lead Free Finish/ RoHS Compliant (Note 2)

General Description

AH289 is a monolithic fan motor controller with Hall sensor's capability. It contains two complementary open-drain transistors for motors coil driving, an automatic lock current shutdown, and recovery protection. In addition, the Rotor-State Detection (RD) output is for Rotor-State Detection.

Rotor-lock shutdown detection circuit turns off the output driver when the rotor is blocked to avoid coil overheat. Then, the automatic recovery circuit will restart the motor. These protected actions are repeated and periodic during the blocked period. Until the blocking is removed, the motor recovers and runs normally.

Typical Application Circuit

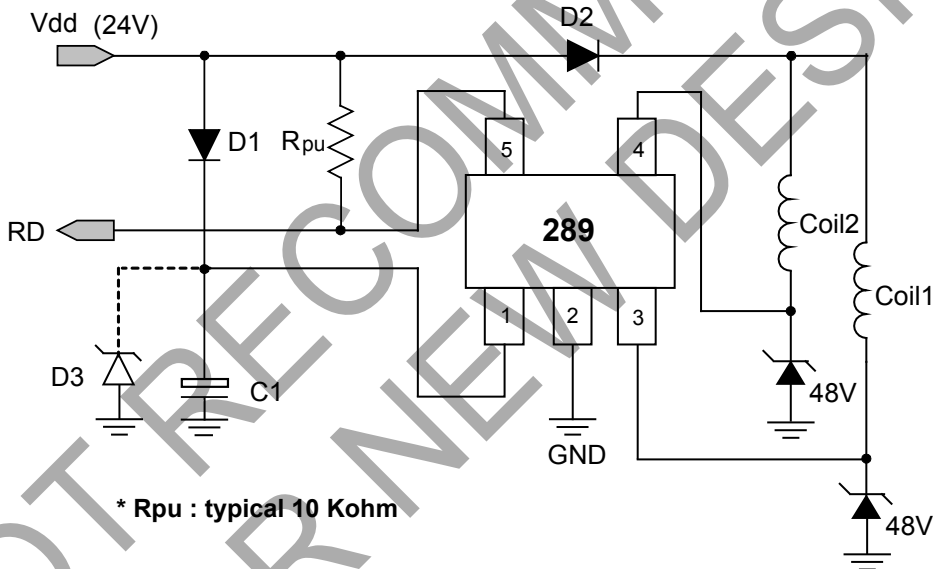

* Rpu : typical 10 Kohm

Note: The optional Capacitor C1 and Diode D3 are for power stabilization. C1 is recommended to be E-Cap., $\mu F/25V$; D3 is recommended to be Zener Diode, $V_z = 27V$. Which C1 and D3 value need to be fine tuned to optimize design for different coils and power suppliers.

24V DC Brush-Less Fan with RD Output Function

Ordering Information

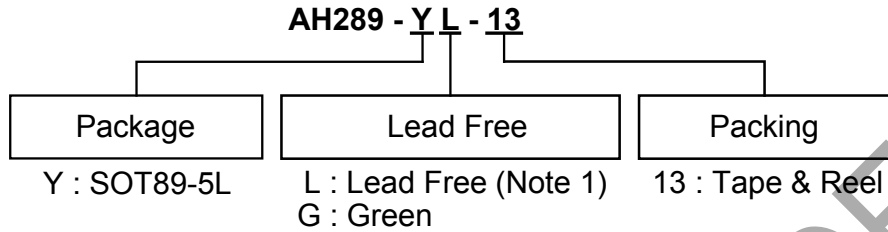

Device	Package Code	Packaging (Note 3)	13" Tape and Reel	
			Quantity	Part Number Suffix
AH289-YL-13	Y	SOT89-5L	2500/Tape & Reel	-13
AH289-YG-13	Y	SOT89-5L	2500/Tape & Reel	-13

- Notes:
- AH289-YL-13 will be replaced by AH289-YG-13
 - EU Directive 2002/95/EC (RoHS). All applicable RoHS exemptions applied. Please visit our website at http://www.diodes.com/products/lead_free.html.
 - Pad layout as shown on Diodes Inc. suggested pad layout document AP02001, which can be found on our website at <http://www.diodes.com/datasheets/ap02001.pdf>.
 - Reverse taping as shown on Diodes Inc. Surface Mount (SMD) Packaging document AP02007, which can be found on our website <http://www.diodes.com/datasheets/ap02007.pdf>.

Pin Assignments

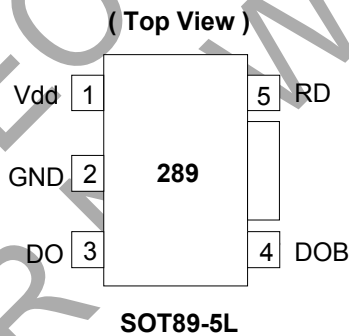

Pin Descriptions

Pin Name	Pin No.	Description
Vdd	1	Input power
GND	2	Ground
DO	3	Output pin
DOB	4	Output pin
RD	5	Rotor-State Detection

Block Diagram

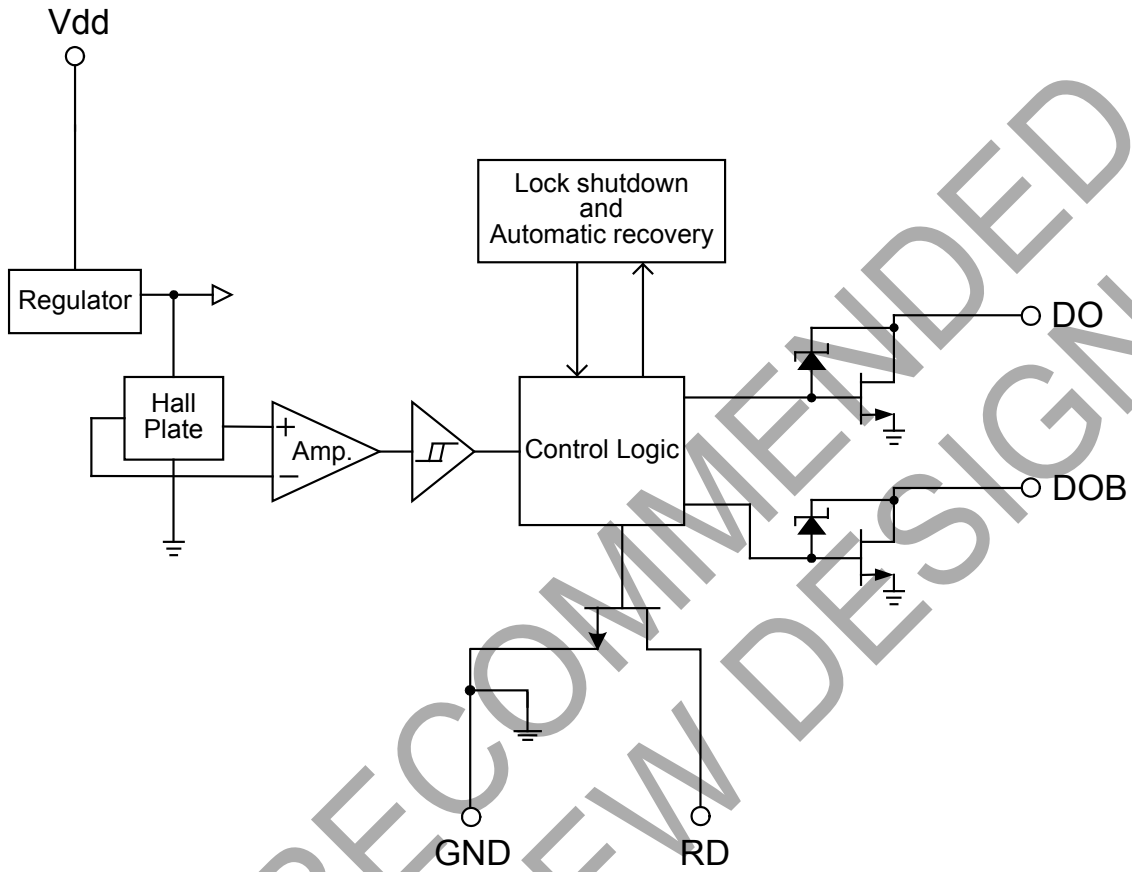

NOT RECOMMENDED FOR NEW DESIGN

Absolute Maximum Ratings ($T_A = 25^{\circ}\text{C}$)

Symbol	Parameter	Rating	Unit
V _{DD}	Supply Voltage	30	V
I _O	Output Current	I _O (AVE)	400 mA
		I _O (PEAK)	700 mA
P _D	Power Dissipation	800	mW
T _{ST}	Storage Temperature	-55 ~ 150	°C
T _J	Maximum Junction Temperature	150	°C
θ _{JA}	Thermal Resistance Junction-to-Case (Note 5)	156	°C/W

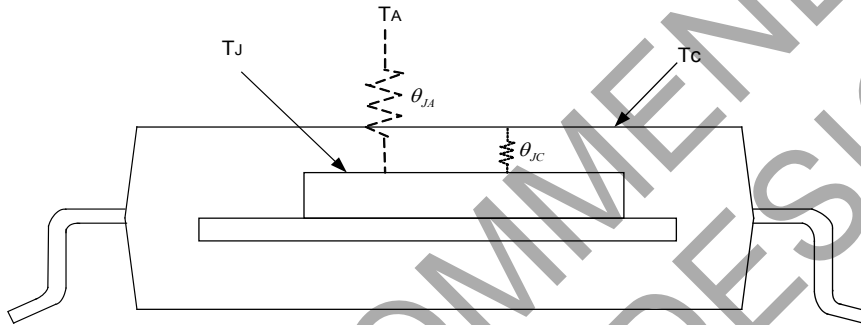

Notes: 5. θ_{JA} should be confirmed with what heat sink thermal resistance. If no heat sink contacting, θ_{JA} is almost the same as θ_{JC}.

Recommended Operating Conditions

Symbol	Characteristic	Conditions	Min	Max	Unit
V _{DD}	Supply Voltage (Note 6)	Operating	3.8	28	V
T _A	Operating Ambient Temperature	Operating	-40	100	°C

Notes: 6. Please watch the current limit issue when the operation voltage is over 26.4V, because of the different efficiency in the coil.

Electrical Characteristics (T_A = 25 °C, V_{DD} = 24V, unless otherwise specified)

Symbol	Parameter	Conditions	Min	Typ.	Max	Unit
I _{DD}	Supply Current	Operating	-	2.0	4.0	mA
I _{OFF}	Output Leakage Current	V _{OUT} = 24V	-	< 0.1	10	μA
T _{LRP-ON}	Locked Protection On		0.4	0.46	0.6	Sec
T _{LRP-OFF}	Locked Protection Off		2.4	2.76	3.6	Sec
V _{OUT(SAT)}	Output Saturation Voltage	I _O = 200mA	-	450	700	mV
		I _O = 300mA	-	680	800	
R _{DS(ON)}	Output On Resistance	I _O = 200mA	-	2.25	3.5	ohm
V _{OL}	RD Output Vds	I _O = 10mA	-	0.3	0.5	V
V _Z	Output Zener-Breakdown Voltage		42	55	65	V

Truth Table (Note 7)

IN-	IN+	CT	OUT1	OUT2	RD	Mode
H	L	L	H	L	L	Rotating
L	H	L	L	H	L	Rotating
-	-	H	off	off	H	Lockup protection activated

Notes: 7. Latch-type RD output is low during rotation and high during stop.

Magnetic Characteristics (T_A = 25 °C, V_{DD} = 24V, unless otherwise specified, Note 8)

(1mT = 10 Gauss)

Symbol	Characteristics	Min	Typ.	Max	Unit
B _{op}	Operation Point	10	30	60	Gauss
B _{rp}	Release Point	-60	-30	-10	Gauss
B _{hy}	Hysteresis	--	60	--	Gauss

Notes: 8. Magnetic characteristics are for design information, which will vary with supply voltage, operating temperature and after soldering.

Operating Characteristics

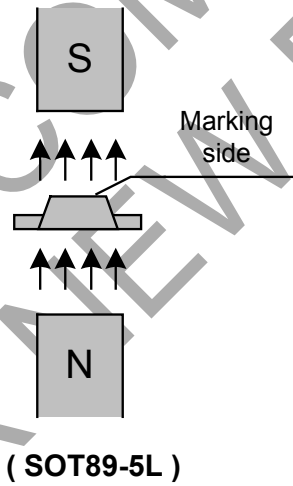
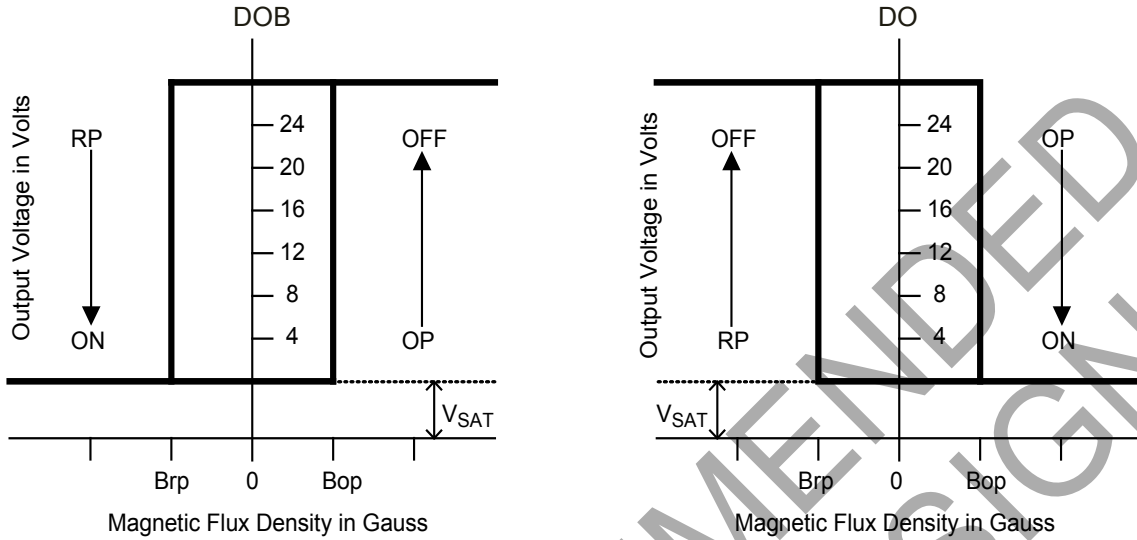

Performance Characteristics (SOT89-5L)

T_A (°C)	25	50	60	70	75	80	85	90	95	100
P_D (mW)	800	640	576	512	480	448	416	384	352	320
T_A (°C)	105	110	115	120	125	130	135	140	145	150
P_D (mW)	288	256	224	192	160	128	96	64	32	0

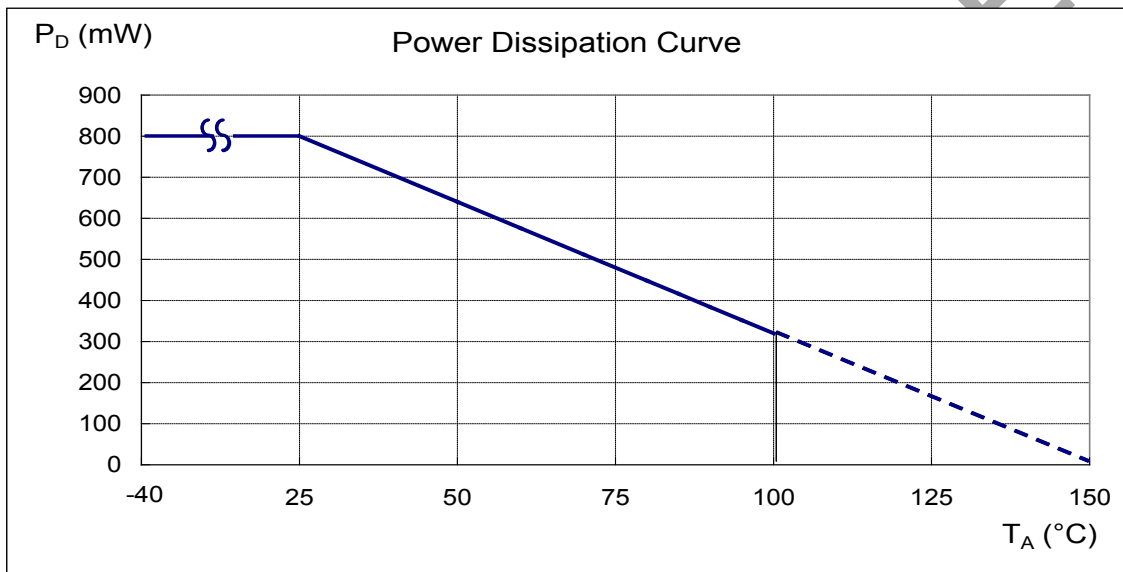

Marking Information

(1) SOT89-5L

(Top View)

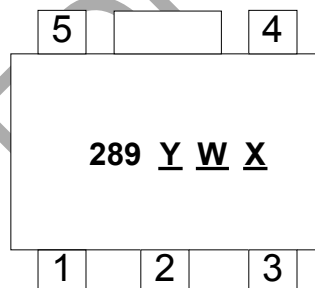

Y : Year : 0~9
W : Week : A~Z : 1~26 week;
 a~z : 27~52 week;
 z represents 52 and 53 week
X : Internal code
 A~Z : Green
 a~z : Lead Free

Package Information (All Dimensions in mm)

(1) Package type: SOT89-5L

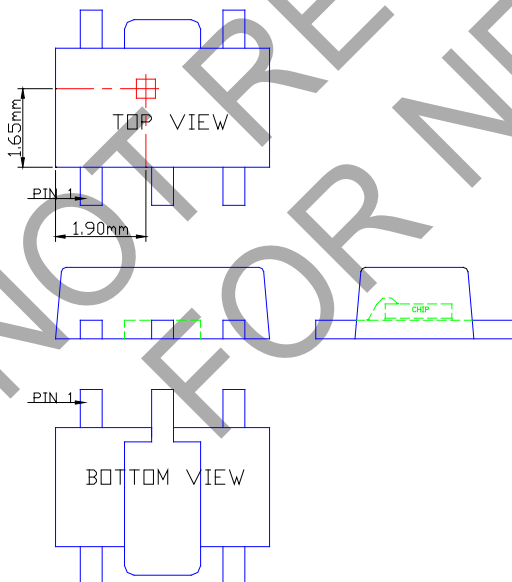
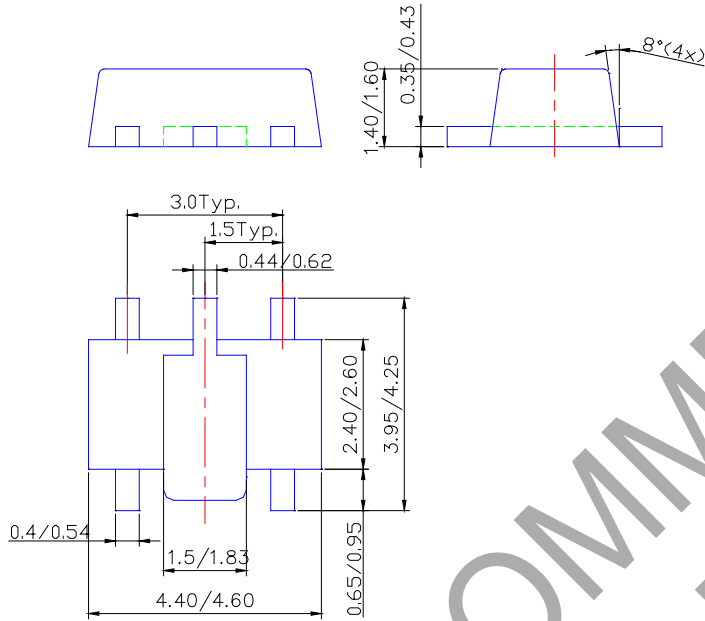

Sensor Location

IMPORTANT NOTICE

1. DIODES INCORPORATED AND ITS SUBSIDIARIES ("DIODES") MAKE NO WARRANTY OF ANY KIND, EXPRESS OR IMPLIED, WITH REGARDS TO ANY INFORMATION CONTAINED IN THIS DOCUMENT, INCLUDING, BUT NOT LIMITED TO, THE IMPLIED WARRANTIES OF MERCHANTABILITY, FITNESS FOR A PARTICULAR PURPOSE OR NON-INFRINGEMENT OF THIRD PARTY INTELLECTUAL PROPERTY RIGHTS (AND THEIR EQUIVALENTS UNDER THE LAWS OF ANY JURISDICTION).

2. The Information contained herein is for informational purpose only and is provided only to illustrate the operation of Diodes products described herein and application examples. Diodes does not assume any liability arising out of the application or use of this document or any product described herein. This document is intended for skilled and technically trained engineering customers and users who design with Diodes products. Diodes products may be used to facilitate safety-related applications; however, in all instances customers and users are responsible for (a) selecting the appropriate Diodes products for their applications, (b) evaluating the suitability of the Diodes products for their intended applications, (c) ensuring their applications, which incorporate Diodes products, comply the applicable legal and regulatory requirements as well as safety and functional-safety related standards, and (d) ensuring they design with appropriate safeguards (including testing, validation, quality control techniques, redundancy, malfunction prevention, and appropriate treatment for aging degradation) to minimize the risks associated with their applications.

3. Diodes assumes no liability for any application-related information, support, assistance or feedback that may be provided by Diodes from time to time. Any customer or user of this document or products described herein will assume all risks and liabilities associated with such use, and will hold Diodes and all companies whose products are represented herein or on Diodes' websites, harmless against all damages and liabilities.

4. Products described herein may be covered by one or more United States, international or foreign patents and pending patent applications. Product names and markings noted herein may also be covered by one or more United States, international or foreign trademarks and trademark applications. Diodes does not convey any license under any of its intellectual property rights or the rights of any third parties (including third parties whose products and services may be described in this document or on Diodes' website) under this document.

5. Diodes products are provided subject to Diodes' Standard Terms and Conditions of Sale (<https://www.diodes.com/about/company/terms-and-conditions/terms-and-conditions-of-sales/>) or other applicable terms. This document does not alter or expand the applicable warranties provided by Diodes. Diodes does not warrant or accept any liability whatsoever in respect of any products purchased through unauthorized sales channel.

6. Diodes products and technology may not be used for or incorporated into any products or systems whose manufacture, use or sale is prohibited under any applicable laws and regulations. Should customers or users use Diodes products in contravention of any applicable laws or regulations, or for any unintended or unauthorized application, customers and users will (a) be solely responsible for any damages, losses or penalties arising in connection therewith or as a result thereof, and (b) indemnify and hold Diodes and its representatives and agents harmless against any and all claims, damages, expenses, and attorney fees arising out of, directly or indirectly, any claim relating to any noncompliance with the applicable laws and regulations, as well as any unintended or unauthorized application.

7. While efforts have been made to ensure the information contained in this document is accurate, complete and current, it may contain technical inaccuracies, omissions and typographical errors. Diodes does not warrant that information contained in this document is error-free and Diodes is under no obligation to update or otherwise correct this information. Notwithstanding the foregoing, Diodes reserves the right to make modifications, enhancements, improvements, corrections or other changes without further notice to this document and any product described herein. This document is written in English but may be translated into multiple languages for reference. Only the English version of this document is the final and determinative format released by Diodes.

8. Any unauthorized copying, modification, distribution, transmission, display or other use of this document (or any portion hereof) is prohibited. Diodes assumes no responsibility for any losses incurred by the customers or users or any third parties arising from any such unauthorized use.

Copyright © 2021 Diodes Incorporated

www.diodes.com