

### Peak Emission Wavelength: 620nm

The 620nm visible emitter series is designed for applications requiring high output and precise optical / mechanical axis alignment. Custom package solutions and sorting are available.

#### FEATURES

- > Hermetically Sealed TO-46
- > High Output Power
- > Narrow Beam Angle
- > High Reliability

#### APPLICATIONS

- > Color Sensor / Money Bill
- > Paper Sensor / Money Bill
- > Bar-code Reader



### Absolute Maximum Ratings (Ta=25°C)



ITEMS	SYMBOL	RATINGS	UNIT
Forward Current (DC)	IF	50	mA
Forward Current (Pulse)*1	IFP	0.5	A
Reverse Voltage	VR	5	V
Power Dissipation	PD	120	mW
Operating Temperature Range	Topr	-20 ~ +85	°C
Storage Temperature Range	Tstg	-30 ~ +100	°C
Junction Temperature	Tj	100	°C
Lead Soldering Temperature*2	Tls	260	°C

\*1: Tw=10μsec, T=10msec. \*2: Time 5 Sec max, Position: Up to 3mm from the body.

### Electrical & Optical Characteristics (Ta = 25°C)

ITEMS	SYMBOL	CONDITIONS	MIN	TYP	MAX	UNIT
Power Output	PO	IF=20mA	--	2.3	--	mW
Forward Voltage	VF	IF=20mA	--	2.2	2.6	V
Reverse Current	IR	VR=5V	--	--	100	μA
Peak Emission Wavelength	λp	IF=20mA	--	620	--	nm
Spectral Line Half Width	Δλ	IF=20mA	--	20	--	nm
Half Intensity Beam Angle	Θ	IF=20mA	--	±5	--	deg

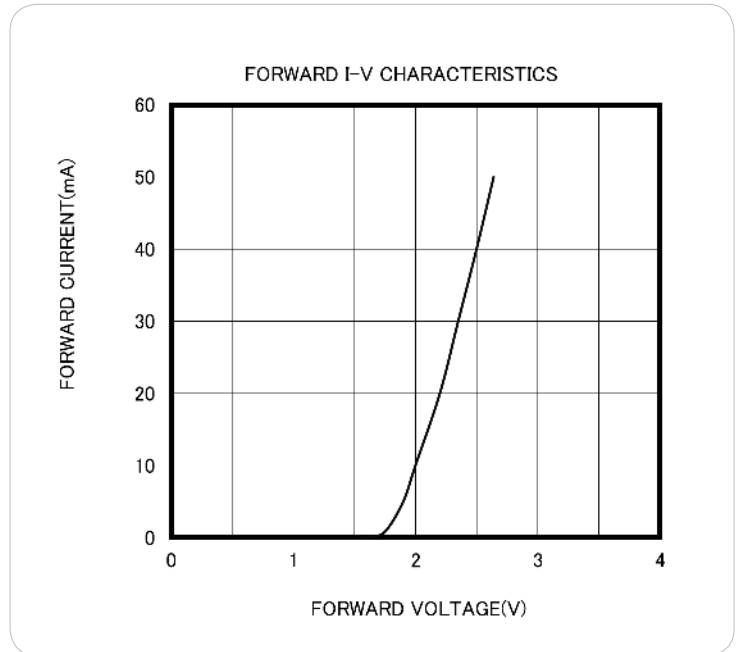
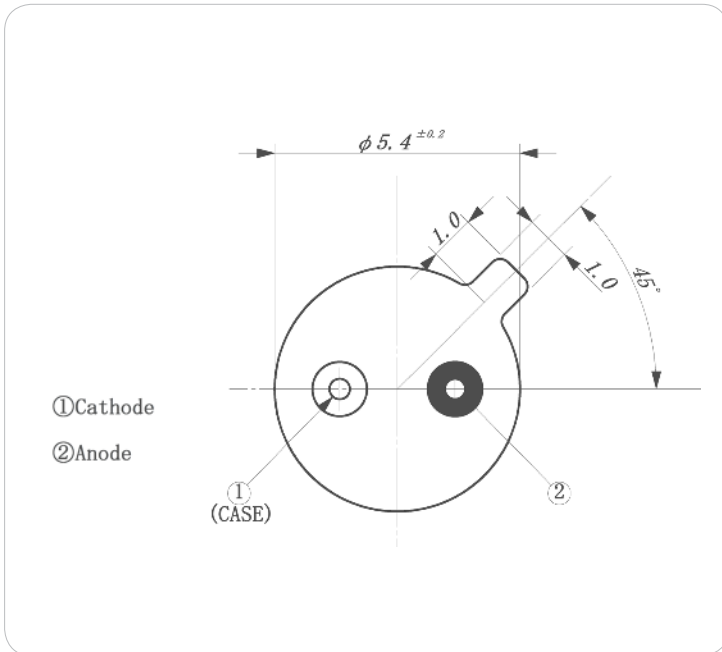
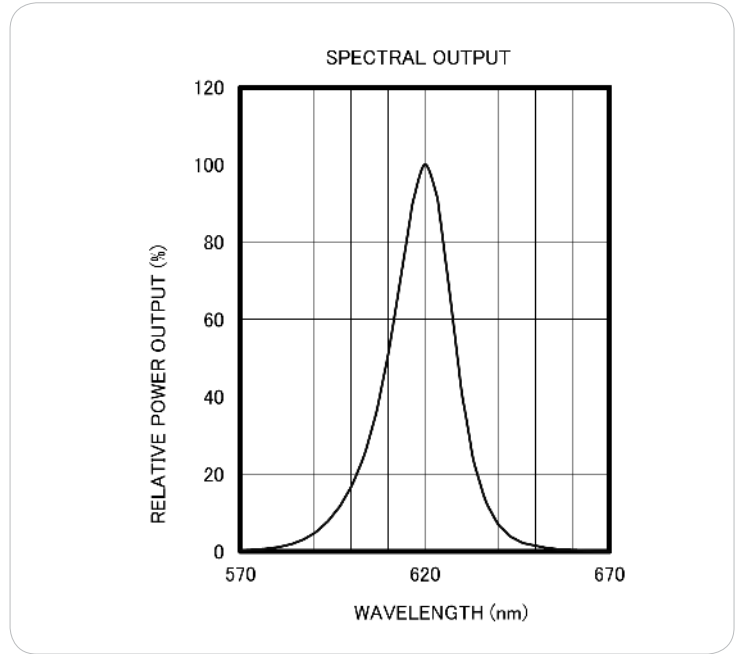
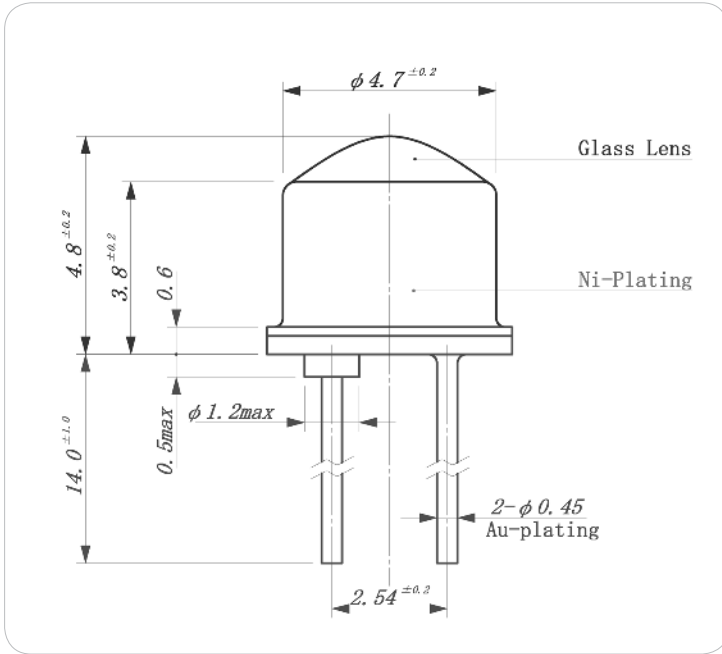

Unit: mm, Tolerance:  $\pm 0.2$

RELATIVE POWER vs FORWARD CURRENT

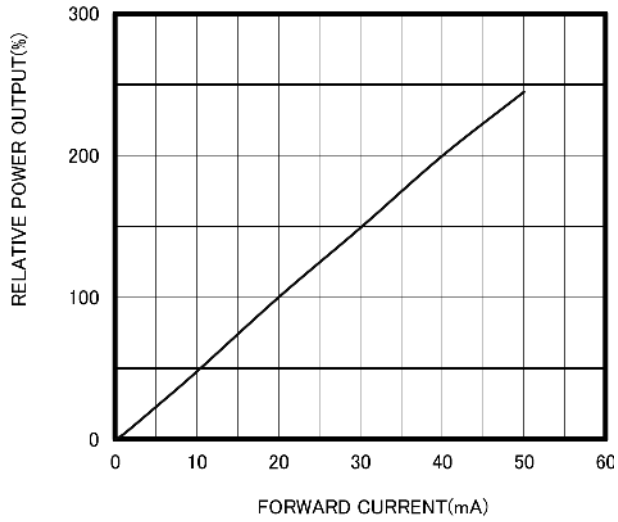

THERMAL DERATING CURVE

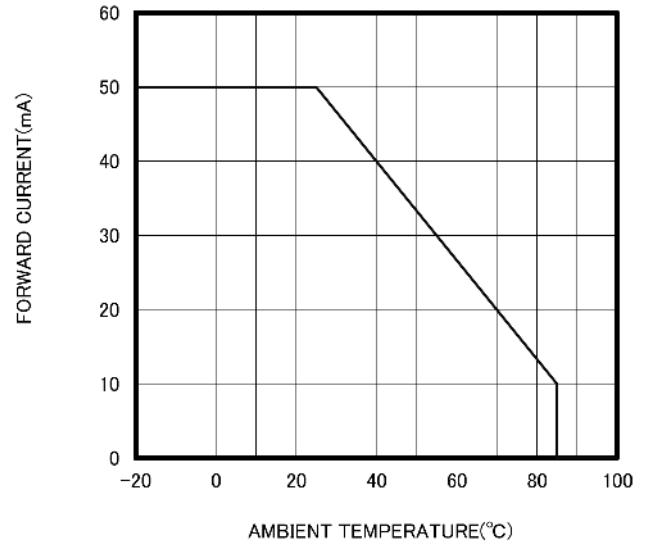

RADIATION PATTERN

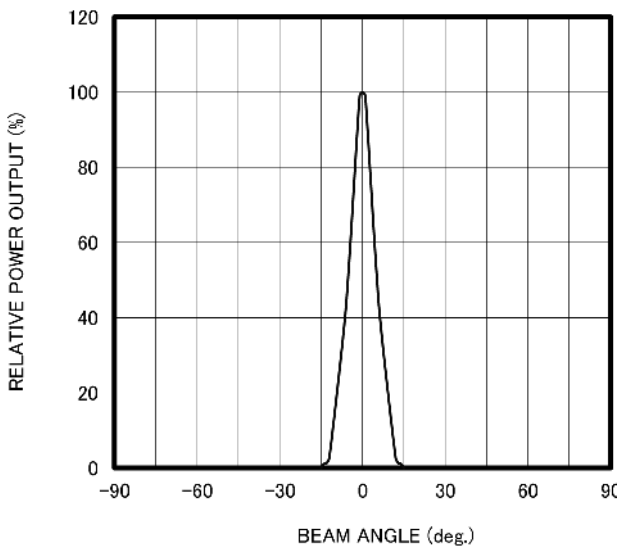

The information contained herein is subject to change without notice.

2016-03-31