

MODEL: HSS24-B20-NP | **DESCRIPTION:** HEAT SINK

FEATURES

- TO-220 or TO-218 package
- bolt on attachment
- aluminum alloy



MODEL

HSS24-B20-NP	thermal resistance ¹				power dissipation ¹
	@ 75°C ΔT, nat conv [°C/W]	@ 1 W, nat conv [°C/W]	@ 1 W, 200 LFM [°C/W]	@ 1 W, 400 LFM [°C/W]	@ 75°C ΔT, nat conv [W]
	9.56	12.5	4.3	2.9	7.85

Note: 1. See performance curves for full thermal resistance details.

PERFORMANCE CURVES

Power [W]	Heatsink Temperature Rise Above Ambient (ΔT = T _{hs} - T _a) [°C]		
	Natural Conv.	200 LFM	400 LFM
0	0	0	0
1	12.5	4.3	2.9
2	23.3	8.6	5.9
3	33.5	13.0	8.9
4	42.7	17.3	11.8
5	52.0	21.7	14.6
6	60.8	26.0	17.5
7	68.9	30.4	20.4
8	76.6	34.7	23.4
9	83.9	39.2	26.3
10	92.1	43.9	29.3
11	99.7	48.1	32.2
12	105.8	52.1	34.9
13	113.0	56.7	38.0
14	119.8	60.7	41.1
15	125.3	64.9	43.8

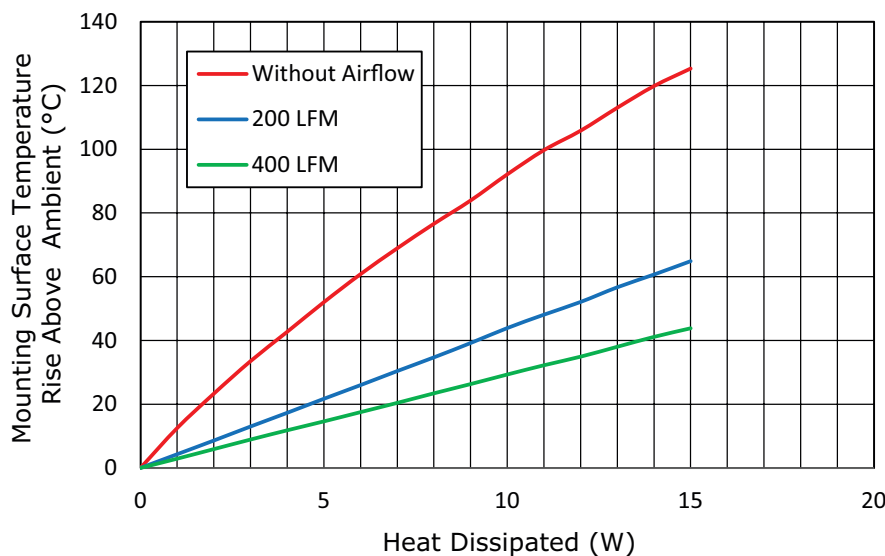

T_{hs}: "hot spot" temperature measured on the heatsink
 T_a: ambient temperature

MECHANICAL DRAWING

units: mm
tolerance: ±0.5 mm

MATERIAL	AL 1050
FINISH	black anodized
THICKNESS	1.5 mm
WEIGHT	15.8 g

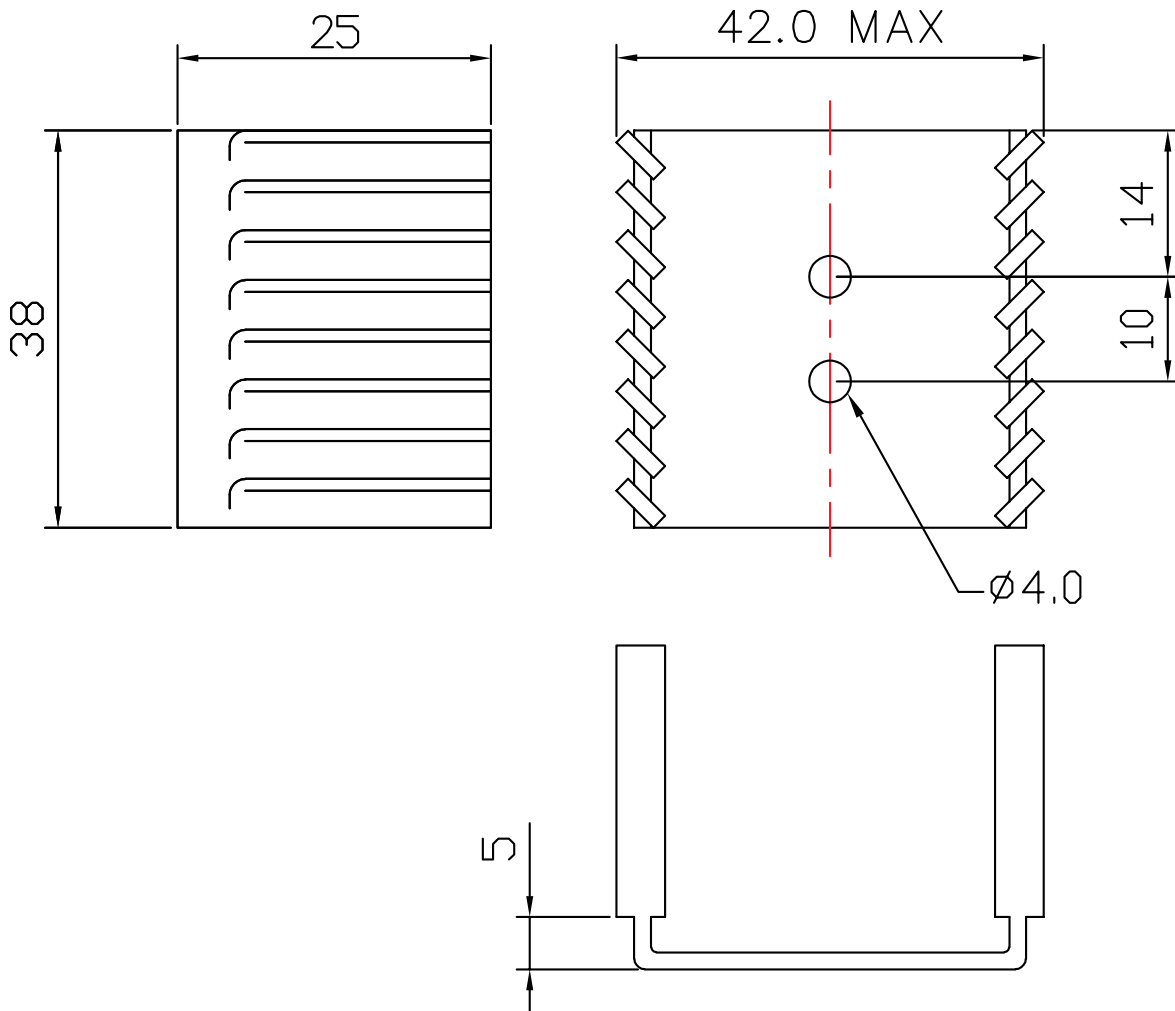

REVISION HISTORY

rev.	description	date
1.0	initial release	04/22/2022
1.01	logo, datasheet style update	08/05/2022

The revision history provided is for informational purposes only and is believed to be accurate.



CUI Devices offers a one (1) year limited warranty. Complete warranty information is listed on our website.

CUI Devices reserves the right to make changes to the product at any time without notice. Information provided by CUI Devices is believed to be accurate and reliable. However, no responsibility is assumed by CUI Devices for its use, nor for any infringements of patents or other rights of third parties which may result from its use.

CUI Devices products are not authorized or warranted for use as critical components in equipment that requires an extremely high level of reliability. A critical component is any component of a life support device or system whose failure to perform can be reasonably expected to cause the failure of the life support device or system, or to affect its safety or effectiveness.

cuidevices.com