

General information

Part number	S21K0C-P04MJG0-550S
Termination	solder
Size	1
Locking principle	push
Coding	0_key
Cable Diameter	cable_mini_55
Cable outlet	bend_relief

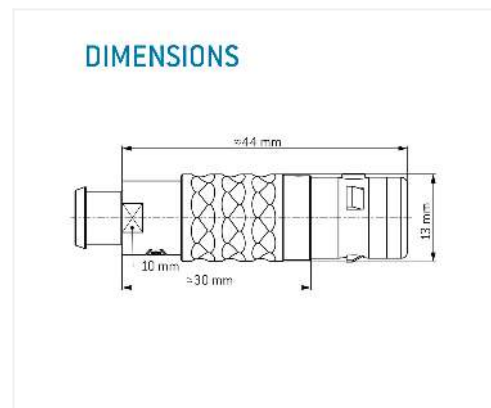
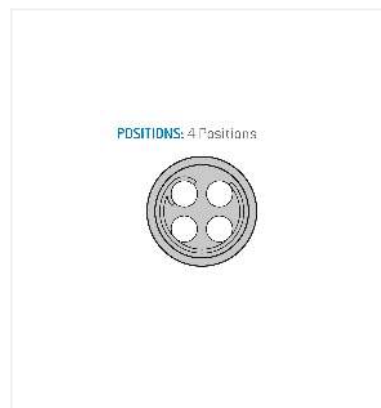

Contact insert description

Number of contacts	4
Contact type	pins
Contact diameter	09mm
Insulator material	peek
Wire cross section	22_awg
Termination	solder
Termination diameter	085mm
Data transmission	ethernet_100

reverse_gender_on_request

Technical information

Max. creepage and air clearance distance	10_mm	11_mm
Nominal current single contact	075_a	iec_60512_5_2
Nominal current insert	7,5 A	vde_0298_4
Test voltage	15_kv_ac	sae_13441

safety_text

Mechanical and environmental data

Degree of protection*	ip68
Operating temperature	40_120_c
Mating cycles	5000

mated

Material and surface treatments

Housing	m_chrome
Contact	cu_alloy_gold

data_text

safety_text_2
data_text
ul_text
illustrative_text