

# Safety Control Relay HR1S-AC

- 1NC or 2NC safety input type, such as E-Stops or Interlock Switches
- EN ISO 13849-1 PLe, Safety Cat 3 compliant, and EN 62061 SIL 3
- Fault diagnosis function with dual safety circuits.
- Internal relay operations can be monitored with LED Indicator.
- Finger-safe protection
- 22.5mm wide, 35mm DIN rail mounting
- UL listed, CSA certified, TÜV NORD approved



## Part Numbers

Part Numbers	Terminal Style
HR1S-AC5121	Integrated Terminal Block
HR1S-AC5121P	Removable Terminal Block

## Specifications

Operating Temperature	-10 to 55°C (no freezing)	
Degree of Protection	Terminal: IP20, Housing: IP40	
Rated Power Voltage	24V AC (-20 to +10%) 50/60 Hz 24V DC (±20%)	
Power Consumption	AC: 2.2 VA (24V AC) maximum DC: 1.2W (24V DC) maximum	
Overcurrent Protection	Electronic	
Control Circuit Voltage	24V	
Performance Level (PL)	e (EN ISO 13849-1)	
Safety Category	3 (EN 954-1)	
Safety Integrity Level (SIL)	3 (EN 62061)	
Response Time	100ms maximum	
Input Synchronization Time	Unlimited	
Overvoltage Category	III	
Pollution Degree	2	
Rated Insulation Voltage	300V	
Safety Outputs	Instantaneous (Stop Cat 0)	3NO
	Auxiliary Contact	1NO (transistor, PNP)
Output Contact Ratings	Safety Circuit	AC-15 C300: U <sub>e</sub> = 240VAC, I <sub>e</sub> =0.75A
		DC-13 U <sub>e</sub> =24VDC, I <sub>e</sub> =2A
	Transistor Circuit	24V/20mA
	Minimum Applicable Load	17V/10mA (initial value)
Operation Frequency	1200 operations/h maximum	
Rated Current	Safety circuit output total: 10.5A maximum	
Wire Size	HR1S-AC5121: 1 × 2.5mm <sup>2</sup> , 2 × 0.75mm <sup>2</sup> maximum HR1S-AC5121P: 1 × 2.5mm <sup>2</sup> , 2 × 1.5mm <sup>2</sup> maximum	
Weight	160g	

Use a 4A fuse (Type gL) for power fuse protection.  
Use a 4A (Type gL) or a 6A fast blow fuse for output fuse protection.

## Dimensions (mm)

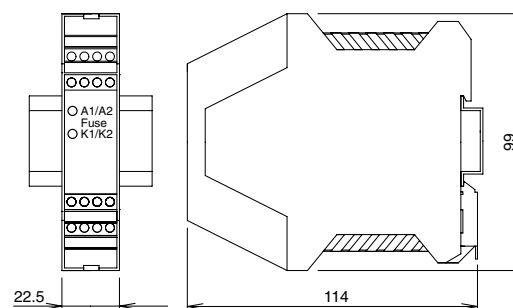

## Terminal Arrangement

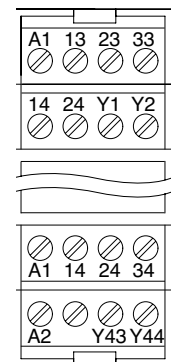

## LED Indicator

- A1/A2 Fuse: Turns on when power circuit is normal. Turns off when power is interrupted or the electronic fuse blows.
- K1: Turns on when K1 relay operates.
- K2: Turns on when K2 relay operates.

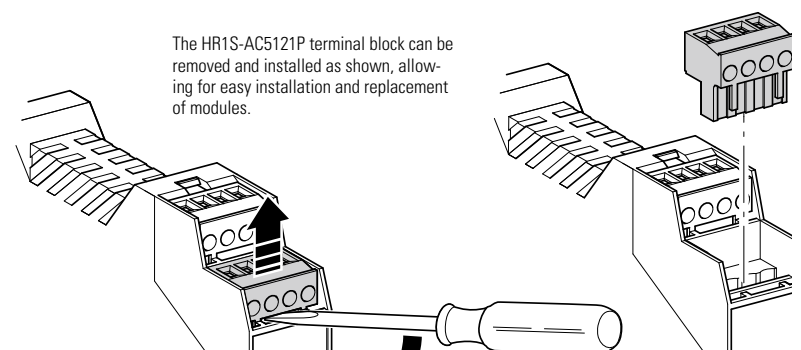

The HR1S-AC5121P terminal block can be removed and installed as shown, allowing for easy installation and replacement of modules.

# HR1S-AC Wiring Diagram

## Safety Category 3 Example Circuit (using an emergency stop switch with 2NC contacts)

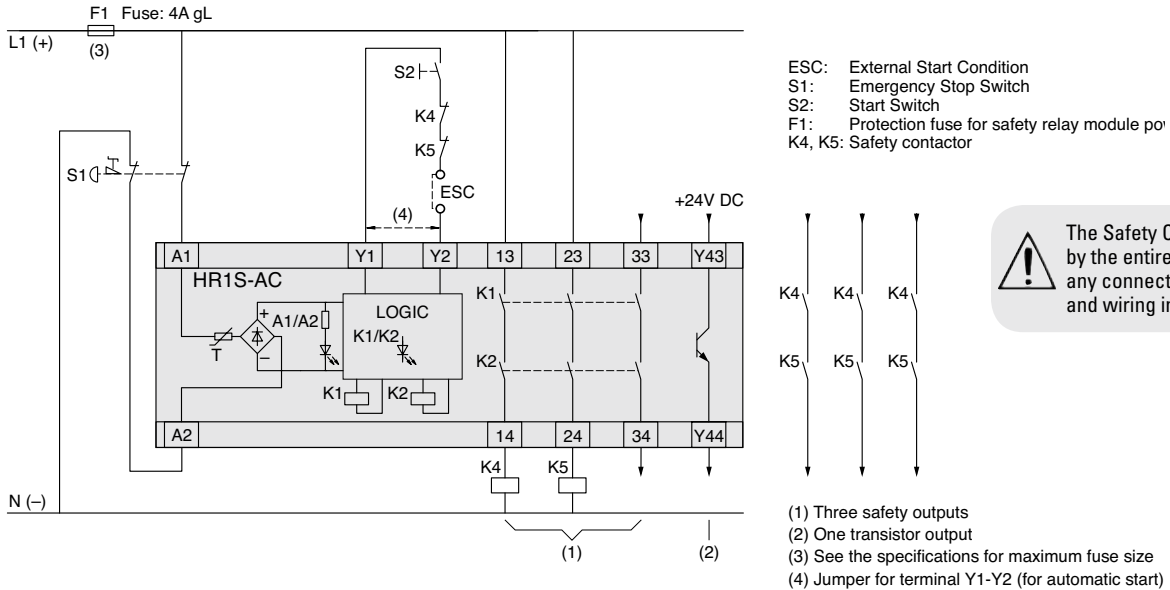

## Safety Category 1 Example Circuit (using an emergency stop switch with 1NC contact)

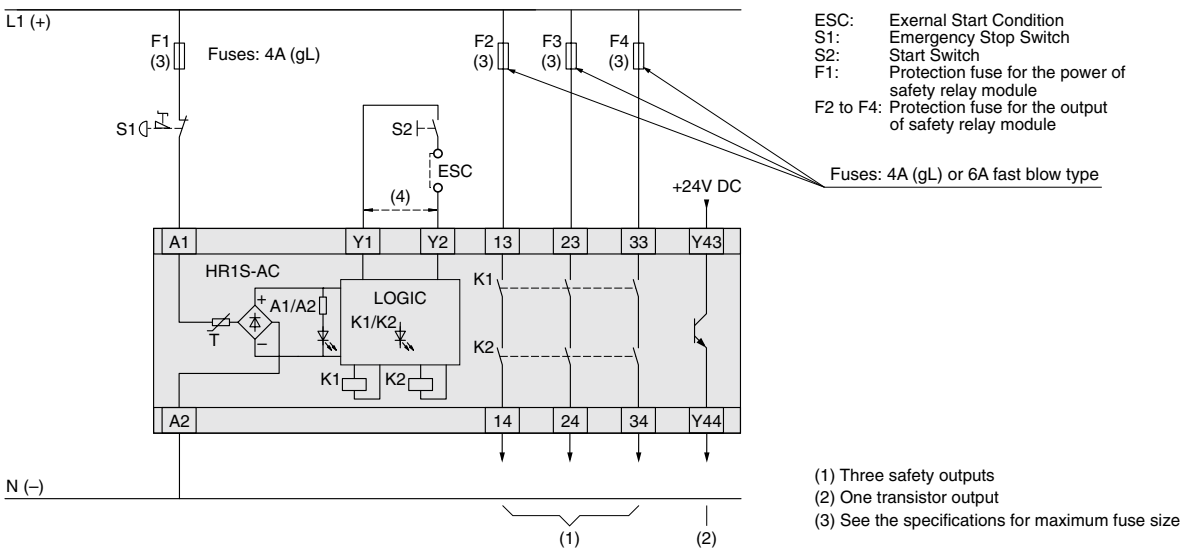

## Output Contact Electrical Life

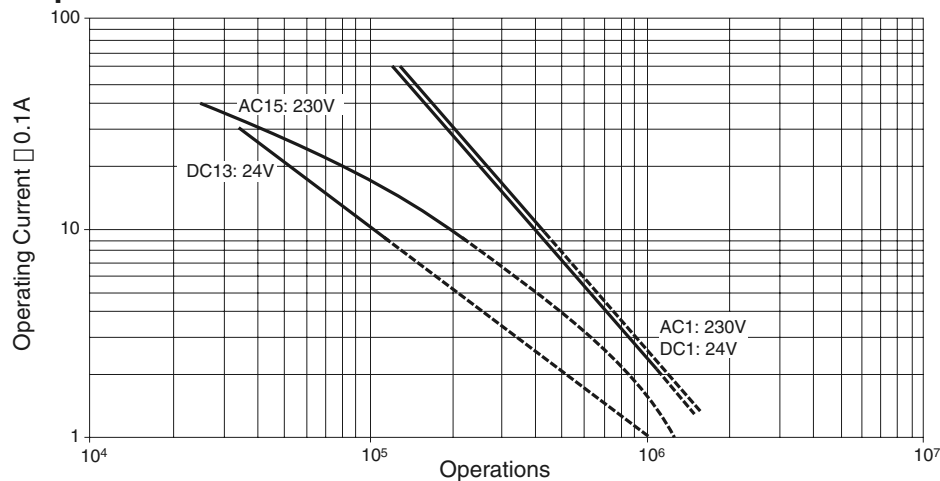

# HR1S-AC Safety Relay Module Operation Chart

## When Using a Start Switch

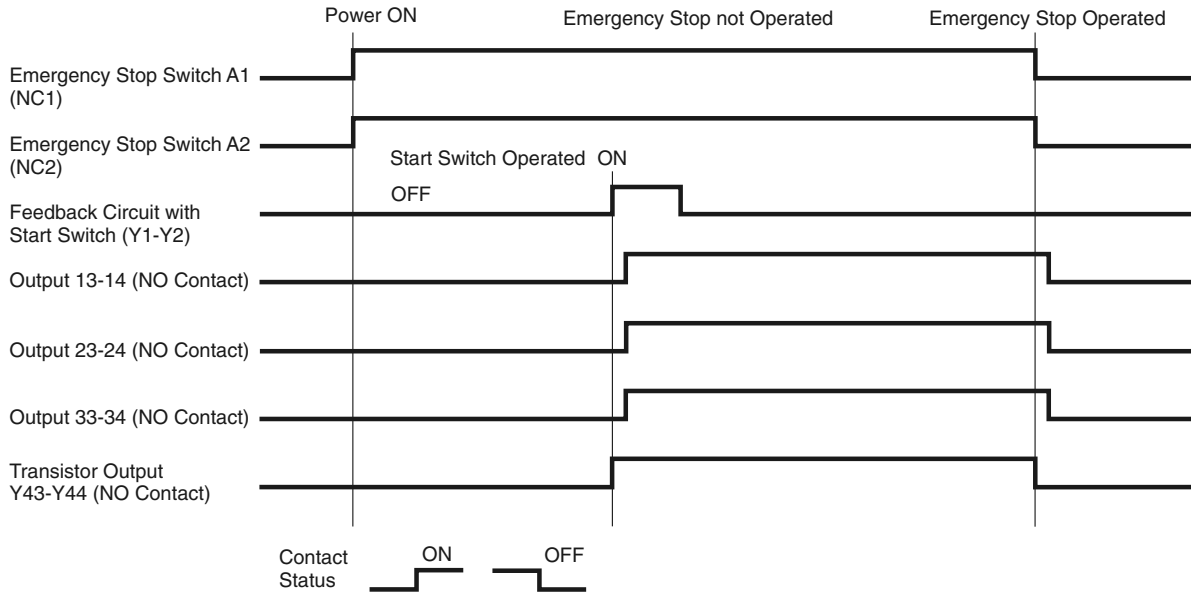

## When not Using the Start Switch

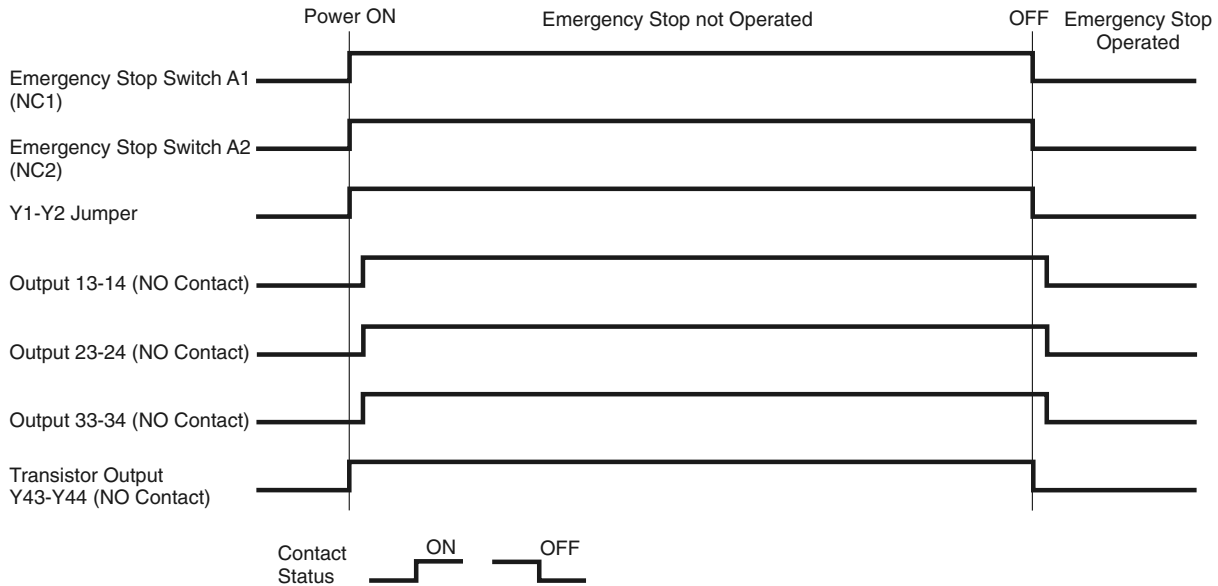

Specifications and other descriptions in this document are subject to change without notice.

