

0.93 (2.4) MAX. .031 (0.8) MIN. PANEL THICKNESS. REMOVE PANEL WASHERS AS REQUIRED (3X .031 (.60) THICK)

ADAPTOR NUTS TO BE FLUSH WITH RECEPTACLE WITH IN .020 (0.5)

NOTES:

- 1. KEYING CODE DOES NOT FORM A PART OF RAYCHEM PART NUMBER SYSTEM AND SHOULD BE OMITTED WHEN ORDERING. KEYING PINS SUPPLIED UNINSTALLED. SEE TABLE II FOR KEYING POSITIONS.
- 2. COMPLETE CONNECTORS AND ACCESSORIES ARE INDIVIDUALLY BAGGED AND LABELED.
- 3. CONNECTOR IS ENVIRONMENTALLY SEALED MEETING THE REQUIREMENTS PER CONNECTOR SPECIFICATION D-8015.
- 4. REAR GROMMET INSERT WILL SEAL ON SMOOTH INSULATION FROM .097" TO .168" O.D.
- 5. CONNECTOR DESIGNED FOR USE WITH POWER AND SHIELDED CONTACTS PER TABLE I.
- 6. INSERTS ARE PERMANENTLY INSTALLED, CONTACTS MAY BE INSERTED AND REMOVED USING TOOL PER NOTE 8.
- 7. ALL UNUSED CAVITIES TO BE SEALED USING SEALING PLUG NUMBER M83723-28-12.
- 8. ALL CONTACTS SIZE 12 ARE INSERTED AND REMOVED USING TOOL NUMBER M83723-31-12.
- 9. REFER TO RAYCHEM SPECIFICATION D-6015 FOR COMPLETE DETAILS.
- 10. CONNECTOR SUPPLIED WITH A SHIPPING DUST CAP OVER ENGAGING END.
- 11. PART NUMBER VARIABLE: MTCR-10X-04S

1- NICKEL PLATE PER MIL-C-26074  
3- CADMIUM PLATE REP QQ-P-416 OVER NICKEL UNDERPLATE

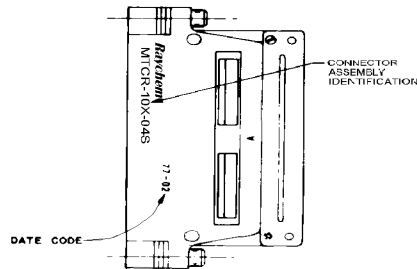

VIEW SHOWING IDENTIFICATION

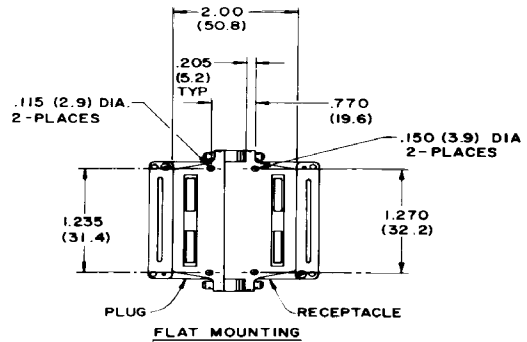









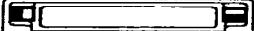

SPECIFICATION CONTROL DRAWING

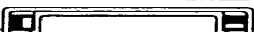
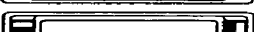
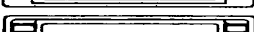
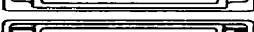
REV	DATE	PART NUMBER	REV	DESCRIPTION
1	12/23			
2	1/10/99			REVISOR: M.HICCY
UNLESS OTHERWISE SPECIFIED DIMENSIONS ARE IN INCHES AND TOLERANCES ARE DEC .XXX .005 DEC .XX .02				
CAD T22668a.TIF			CRN 9-20-77	Raychem
PCN, NO.			92477	CONNECTOR, RCPT, RECTANGULAR, ENVIRONMENTAL, FIXED SKT INSERT ONE INCH MTC SERIES
A 06090			AW	DWG. NO. MTCR-10X-04S E
				SHEET: 1 OF 2

If this document is printed it becomes uncontrolled.  
Check with the web for latest revision.

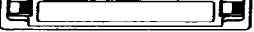
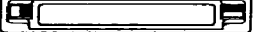
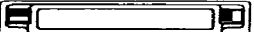
**TABLE II**  
KEYING CODE CHART 

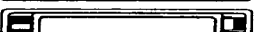
PART NUMBER 	* *	POSITION OF KEYS
MTCR-10X-04S-	AA	
	AB	
	AC	
	AD	
	BA	
	BB	
	BC	
	BD	
	CA	
	CB	
	CC	
	CD	
	DA	
	DB	
	DC	
	DD	
	MTCR-10X-04S-	

**TABLE I**

SOCKET CONTACT AND TOOLING INFORMATION

CONTACT TYPE	MILITARY PART NO.	WIRE STRIP LENGTH	TERMINATION TOOL
SHIELDED CONTACT FOR COAX CABLE D-602-0107 OR D-602-0095	_____	SEE DRAWING D-602-0107 OR D-602-0095	SEE DRAWING D-602-0107 OR D-602-0095
CONTACT FOR TWISTED PAIR D-602-0105	_____	SEE DRAWING D-602-0105	SEE DRAWING D-602-0105
POWER CONTACT SIZE 12	M39029/5-12-12	1/4" TO 5/16"	M22520/1-01 POSITIONER M22520/1-02

If this document is printed it becomes uncontrolled.  
Check with the web for latest revision.

<b>A</b>	CODE IDENT. NO.	DWG. NO.	<b>E</b>
	06090	MTCR-10X-04S	
DO NOT SCALE THIS DRAWING		CAP NAME: T22668D.TIF	SHEET 2 OF 2