

# Screw Mount Active GNSS Antenna



AEACMK0660746-SG4



76.0 x Ø66.0 mm  
RoHS/RoHS II Compliant  
MSL = 1

## Features

- Multiband GNSS antenna
- Covers GPS, GLONASS, BEIDOU, Galileo bands
- High Gain of 5dBic
- RHCP polarization
- Active GNSS with integrated LNA
- High LNA gain of 40 dB
- High positioning accuracy
- Screw Mounting

## Applications

- GPS/GLONASS/BeiDou/Galileo applications
- IoT
- M2M
- Surveillance
- Fleet management and asset tracking
- Autonomous driving
- Telematics
- Agriculture
- Instrumentation
- Survey

## Electrical Specifications

Parameters	Min.	Typ.	Max.	Units	Notes
<b>Antenna</b>					
Center Frequency	1561		1602	MHz	
VSWR			1.5		
Gain		5		dBic	Zenith; Ground plane size: 100 mm
Axial Ratio		4		dB	
Impedance		50		Ω	
Polarization		RHCP			
<b>LNA</b>					
LNA Gain		40		dB	
Noise Figure			2.5	dB	
Ex-Band Attenuation		50		dB	@ CF ± 50 MHz
VSWR			2		
Supply Voltage	2.7		10	V	DC
Current Consumption			25	mA	
Impedance		50		Ω	

## Mechanical Specification

Parameters	Description	Notes
Connector	TNC (F)	
Radome Material	ABS	
Mounting Method	Screw / Body	

# Screw Mount Active GNSS Antenna



AEACMK0660746-SG4



76.0 x Ø66.0 mm  
RoHS/RoHS II Compliant  
MSL = 1

## Environmental Specification

Parameters	Description	Notes
Operating Temperature	-40°C to +85°C	
Relative Humidity	Up to 95 %	
Ingress Protection	IP67	
Vibration	10 ~ 55 Hz with 1.5 mm amplitude 2 hours	
Shock	Vertical axis: 50G, Other axes: 30G	
ESD	15 KV	Air discharge

## Product Dimension

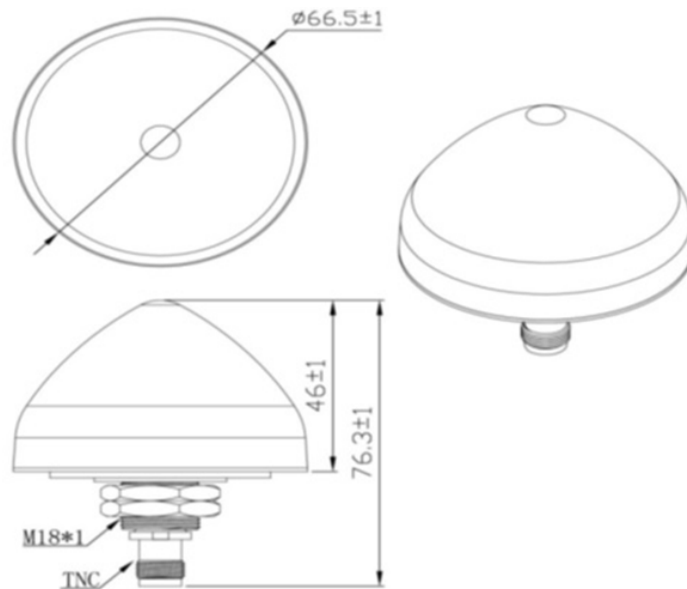

Dimensions: mm

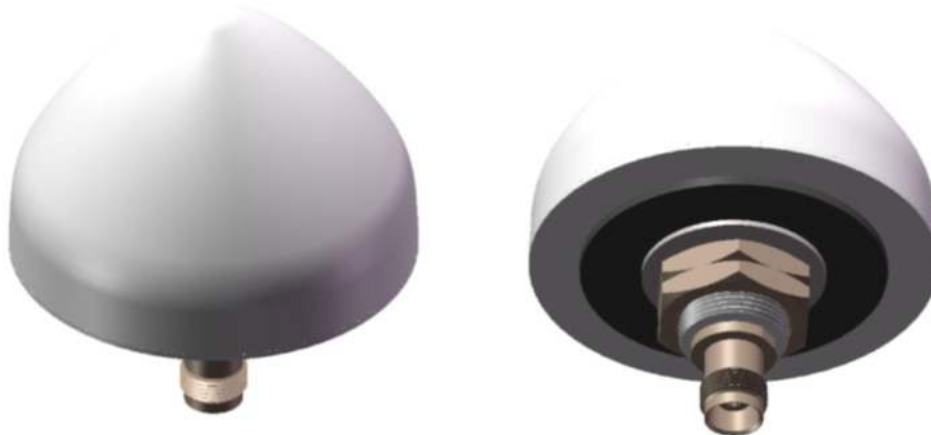

# Screw Mount Active GNSS Antenna



AEACMK0660746-SG4



76.0 x Ø66.0 mm  
RoHS/RoHS II Compliant  
MSL = 1

## VSWR

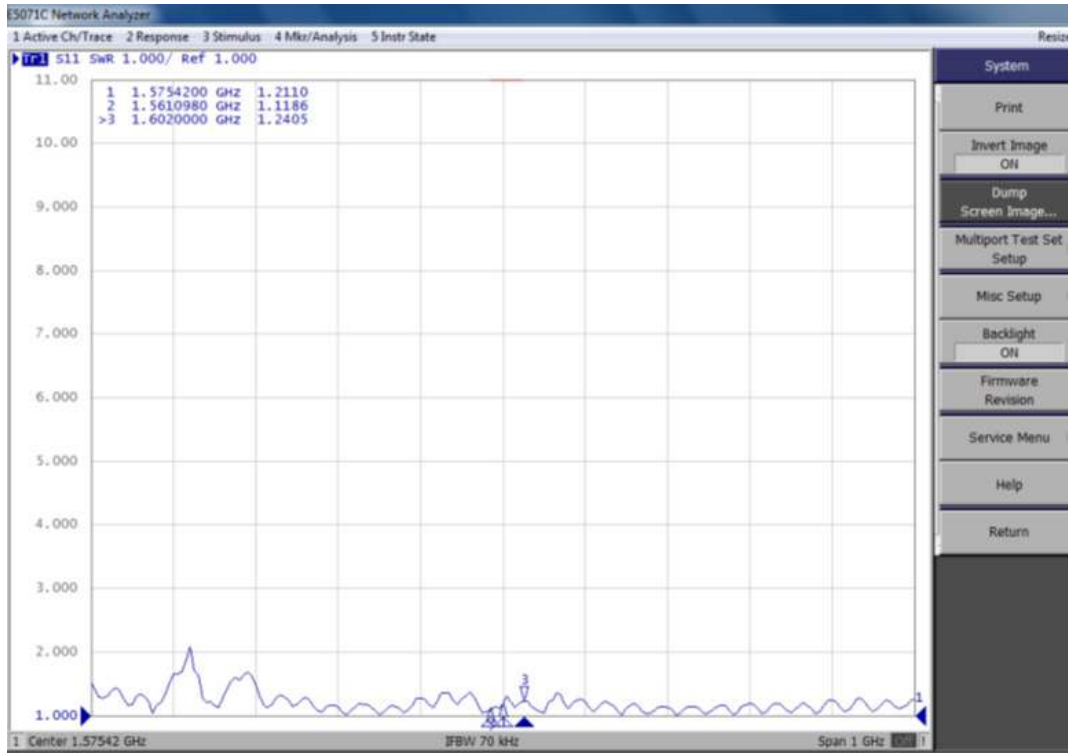

# Screw Mount Active GNSS Antenna



AEACMK0660746-SG4



76.0 x Ø66.0 mm  
RoHS/RoHS II Compliant  
MSL = 1

## Radiation Pattern

### 2D Pattern

XY Plane

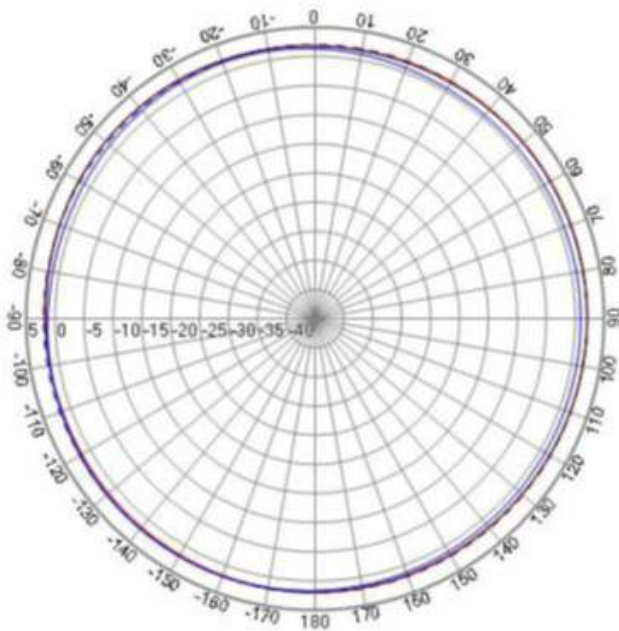

XZ Plane

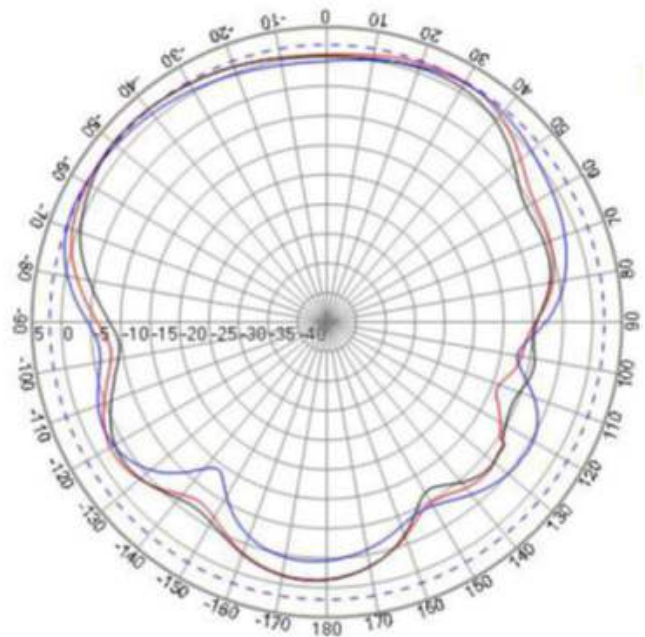

YZ Plane

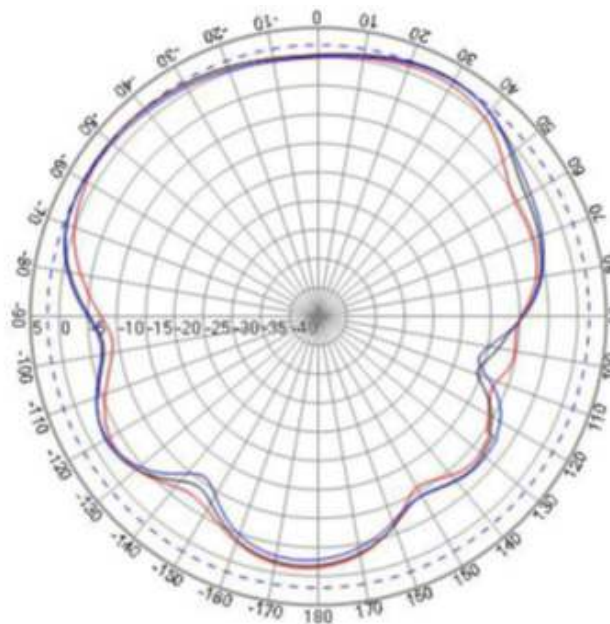

--- 1561 MHz  
--- 1575 MHz  
--- 1602 MHz

# Screw Mount Active GNSS Antenna



AEACMK0660746-SG4



76.0 x Ø66.0 mm  
RoHS/RoHS II Compliant  
MSL = 1

## Radiation Pattern

### 3D Pattern

1561 MHz

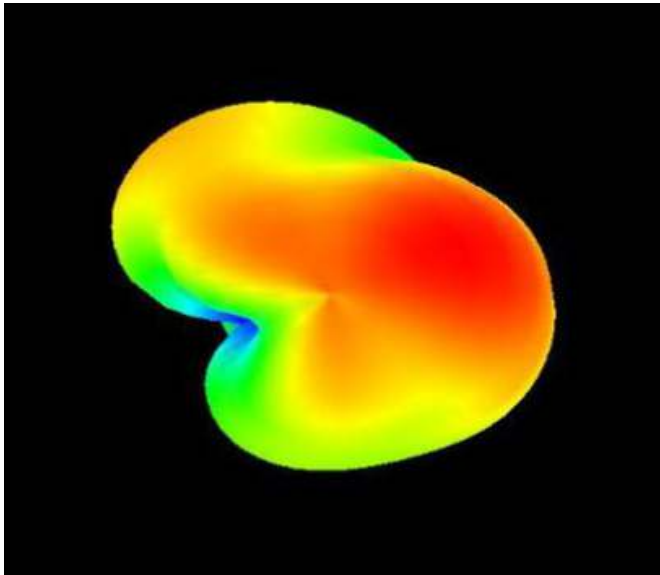

1575 MHz

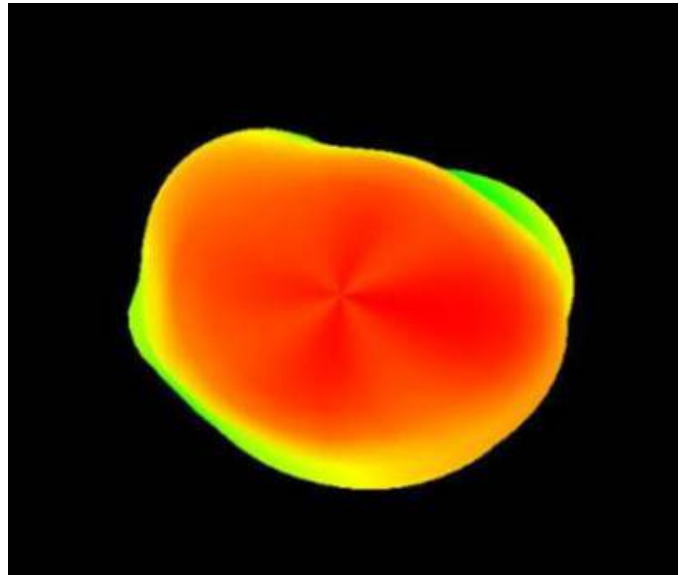

1602 MHz

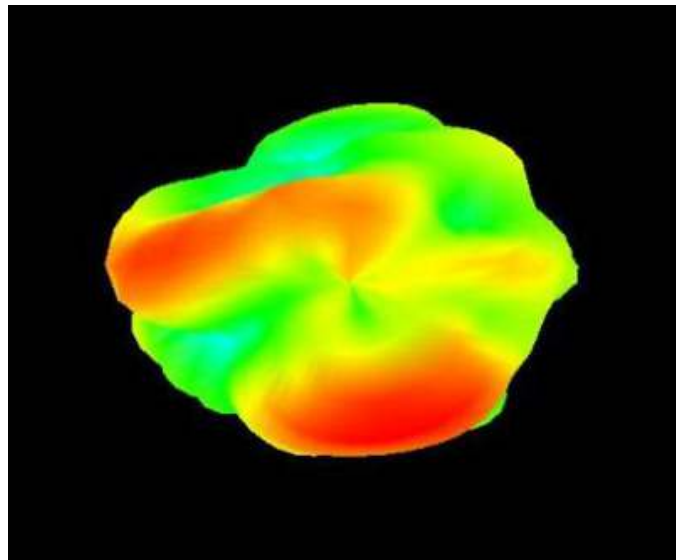

# Screw Mount Active GNSS Antenna



AEACMK0660746-SG4



76.0 x Ø66.0 mm  
RoHS/RoHS II Compliant  
MSL = 1

## Packaging

A carton holds 50 pcs of antenna. Each carton is 38 x 38 x 19 cm and weighs 10 kg.

**ATTENTION:** Abracon LLC's products are COTS – Commercial-Off-The-Shelf products; suitable for Commercial, Industrial and, where designated, Automotive Applications. Abracon's products are not specifically designed for Military, Aviation, Aerospace, Life-dependent Medical applications or any application requiring high reliability where component failure could result in loss of life and/or property. For applications requiring high reliability and/or presenting an extreme operating environment, written consent and authorization from Abracon LLC is required. Please contact Abracon LLC for more information.



5101 Hidden Creek Ln Spicewood TX 78669  
Phone: 512-371-6159 | Fax: 512-351-8858  
For terms and conditions of sales, please visit:  
[www.abracon.com](http://www.abracon.com)

REVISED: 11-4-20

ABRACON IS  
ISO9001-2015  
CERTIFIED