

Standard 1 A Triacs

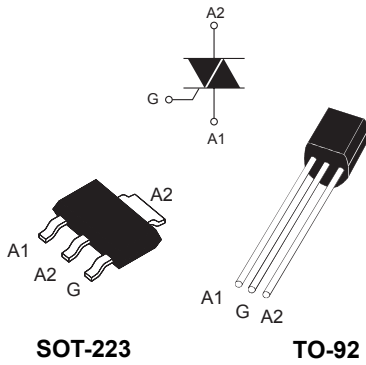

Features

- On-state rms current, $I_{T(RMS)}$ 1 A
- Repetitive peak off-state voltage, V_{DRM}/V_{RRM} 600 or 800 V
- Triggering gate current, $I_{GT(Q1)}$ 3 to 25 mA

Applications

- AC switching
- Home appliances

Description

The Z01 series is suitable for general purpose AC switching applications. These devices are typically used in applications such as home appliances (electrovalve, pump, door lock, small lamp control), fan speed controllers,...

Different gate current sensitivities are available, allowing optimized performance when driven directly through microcontroller.

Product status link

[Z01](#)

Product summary

$I_{T(RMS)}$	1 A
V_{DRM}/V_{RRM}	600, 800 V
$I_{GTstandard}$	3 to 25 mA

1 Characteristics

Table 1. Absolute maximum ratings

Symbol	Parameters	Value	Unit	
$I_{T(RMS)}$	RMS on-state current (full sine wave)	SOT-223 $T_{tab} = 90\text{ }^{\circ}\text{C}$	1	A
		TO-92 $T_L = 50\text{ }^{\circ}\text{C}$		
		SMBflat-3L $T_{tab} = 107\text{ }^{\circ}\text{C}$		
I_{TSM}	Non repetitive surge peak on-state current (full cycle, T_j initial = $25\text{ }^{\circ}\text{C}$)	F = 50 Hz $t_p = 20\text{ ms}$	8	A
		F = 60 Hz $t_p = 16.7\text{ ms}$	8.5	
I^2t	I^2t value for fusing	$t_p = 10\text{ ms}$	0.35	A^2s
di/dt	Critical rate of rise of on-state current $I_G = 2 \times I_{GT}$, $t_r \leq 100\text{ ns}$	F = 120 Hz $T_j = 125\text{ }^{\circ}\text{C}$	20	$\text{A}/\mu\text{s}$
I_{GM}	Peak gate current	$t_p = 20\text{ }\mu\text{s}$ $T_j = 125\text{ }^{\circ}\text{C}$	1	A
$P_{G(AV)}$	Average gate power dissipation	$T_j = 125\text{ }^{\circ}\text{C}$	1	W
T_{stg}	Storage junction temperature range		-40 to +150	$^{\circ}\text{C}$
T_j	Operating junction temperature range		-40 to +125	$^{\circ}\text{C}$

Table 2. Electrical characteristics ($T_j = 25\text{ }^{\circ}\text{C}$, unless otherwise specified)

Symbol	Parameters	Quadrant		Value				Unit
				Z01				
				03	07	09	10	
$I_{GT}^{(1)}$	$V_D = 12\text{ V}$, $R_L = 30\text{ }\Omega$	I - II - III	Max.	3	5	10	25	mA
		IV		5	7	10	25	
V_{GT}		All	Max.	1.3				V
V_{GD}	$V_D = V_{DRM}$, $R_L = 3.3\text{ k}\Omega$, $T_j = 125\text{ }^{\circ}\text{C}$	All	Min.	0.2				V
$I_H^{(2)}$	$I_T = 50\text{ mA}$		Max.	7	10	10	25	mA
I_L	$I_G = 1.2 I_{GT}$	I - III - IV	Max.	7	10	15	25	mA
		II	Max.	15	20	25	50	
$dV/dt^{(2)}$	$V_D = 67\% V_{DRM}$ gate open, $T_j = 110\text{ }^{\circ}\text{C}$		Min.	10	20	50	100	$\text{V}/\mu\text{s}$
$(dV/dt)_c^{(2)}$	$(di/dt)_c = 0.44\text{ A/ms}$, $T_j = 110\text{ }^{\circ}\text{C}$		Min.	0.5	1	2	5	$\text{V}/\mu\text{s}$

1. Minimum I_{GT} is guaranteed at 5% of I_{GT} max.
2. For both polarities of A2 referenced to A1

Table 3. Static electrical characteristics

Symbol	Test conditions	T_j		Value	Unit
$V_T^{(1)}$	$I_{TM} = 1.4 \text{ A}$, $t_p = 380 \mu\text{s}$	25 °C	Max.	1.60	V
$V_{TO}^{(1)}$	Threshold on-state voltage	125 °C	Max.	0.95	V
R_d	Dynamic resistance	125 °C	Max.	400	mΩ
I_{DRM} I_{RRM}	$V_{DRM} = V_{RRM}$	25 °C	Max.	5	μA
		125 °C		0.5	mA

1. For both polarities of A2 referenced to A1

Table 4. Thermal resistance

Symbol	Parameters		Max. value	Unit
$R_{th(j-t)}$	Max. junction to tab (AC)	SOT-223	25	°C/W
		SMBflat-3L	14	
$R_{th(j-l)}$	Max. junction to lead (AC)	TO-92	60	
$R_{th(j-a)}$	Junction to ambient ($S^{(1)} = 5 \text{ cm}^2$)	SOT-223	60	
		SMBflat-3L	75	
	Junction to ambient	TO-92	150	

1. Copper surface under tab.

1.1 Characteristics (curves)

Figure 1. Maximum power dissipation versus on-state RMS current (full cycle)

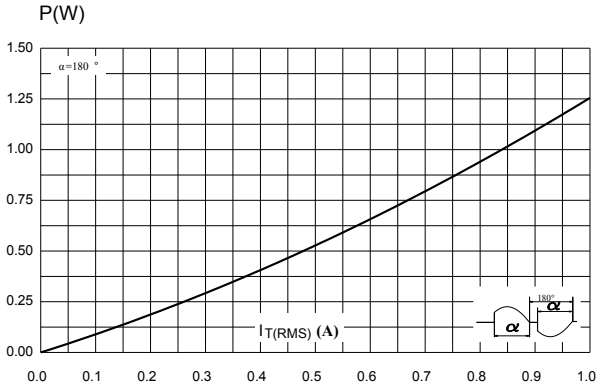

Figure 2. RMS on-state current versus lead (TO-92) or tab (SOT-223, SMBflat-3L) temperature (full cycle)

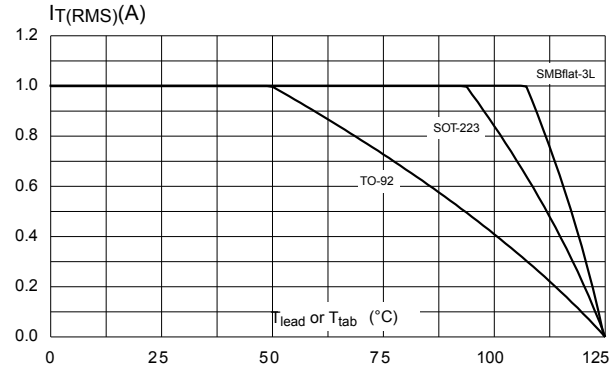

Figure 3. On-state rms current versus ambient temperature (free air convection full cycle)

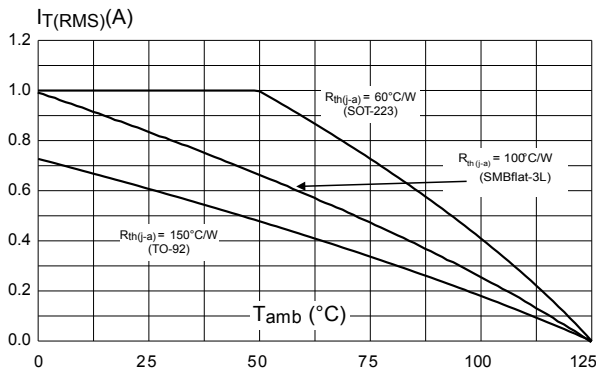

Figure 4. Relative variation of thermal impedance versus pulse duration ($Z_{th(j-a)}$)

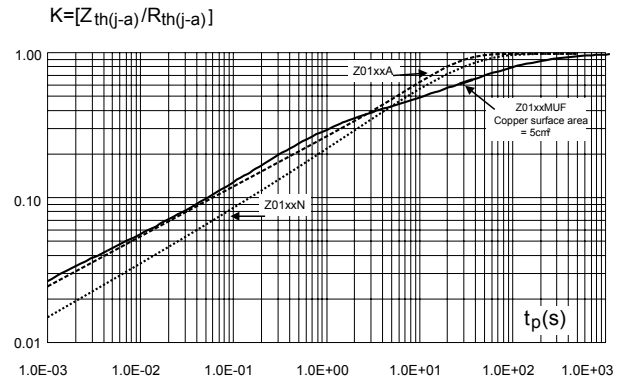

Figure 5. Relative variation of holding current and latching current versus junction temperature (typ. values)

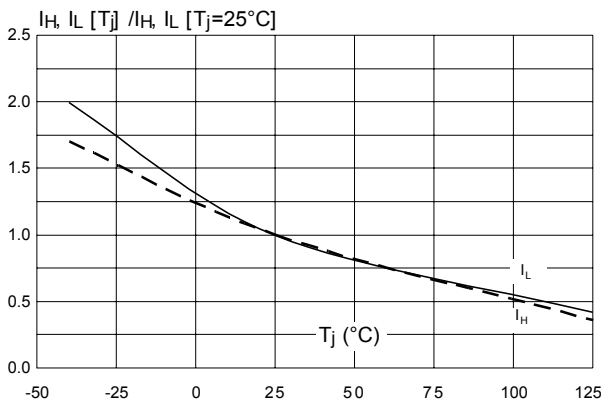

Figure 6. Relative variation of gate trigger current (I_{GT}) and voltage (V_{GT}) versus junction temperature

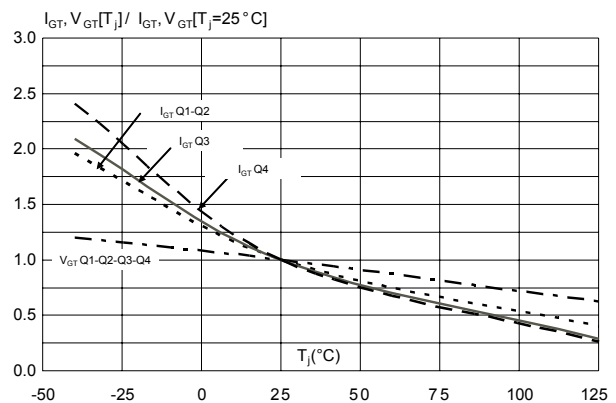

Figure 7. Surge peak on-state current versus number of cycles

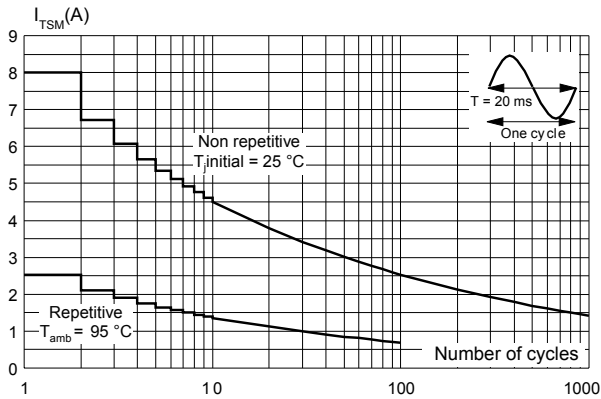

Figure 8. Non-repetitive surge peak on-state current and corresponding value of I^2t sinusoidal pulse width

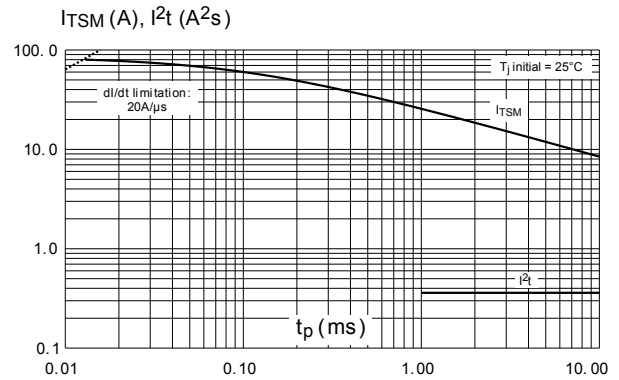

Figure 9. On-state characteristics (maximum values) ($I_{TM} = f(V_{TM})$)

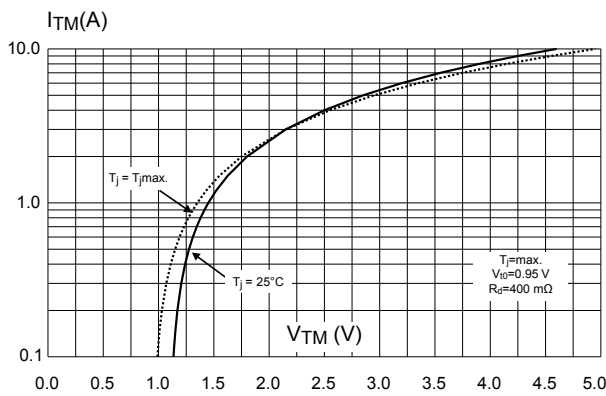

Figure 10. Relative variation of critical rate of decrease of main current (dI/dt) versus junction temperature

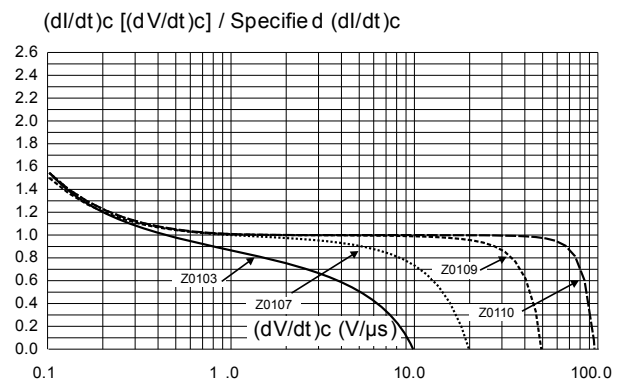

Figure 11. Relative variation of critical rate of decrease of main current (dI/dt) versus junction temperature

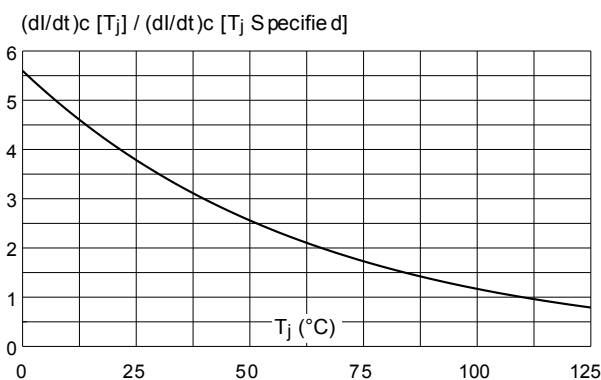

Figure 12. SOT-223 and SMBflat-3L thermal resistance junction to ambient versus copper surface under case

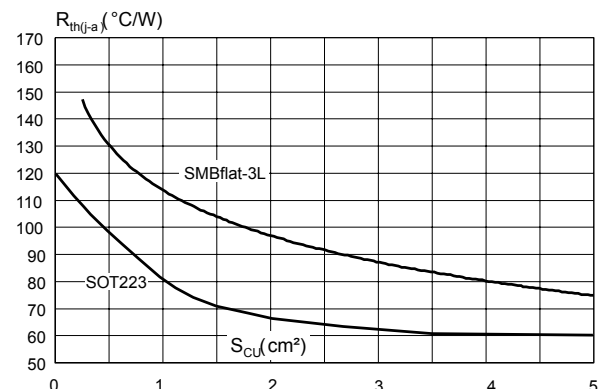
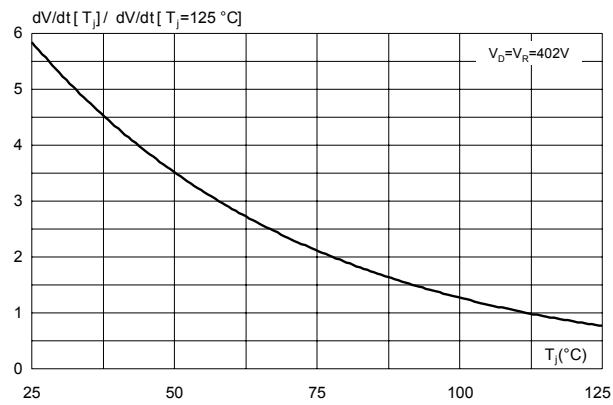

Figure 13. Relative variation of static dV/dt immunity versus junction temperature (gate open)



2 Package information

In order to meet environmental requirements, ST offers these devices in different grades of **ECOPACK** packages, depending on their level of environmental compliance. ECOPACK specifications, grade definitions and product status are available at: www.st.com. ECOPACK is an ST trademark.

2.1 SOT-223 package information

- Epoxy meets UL94, V0
- Lead free plating + halogen-free molding resin

Figure 14. SOT-223 package outline

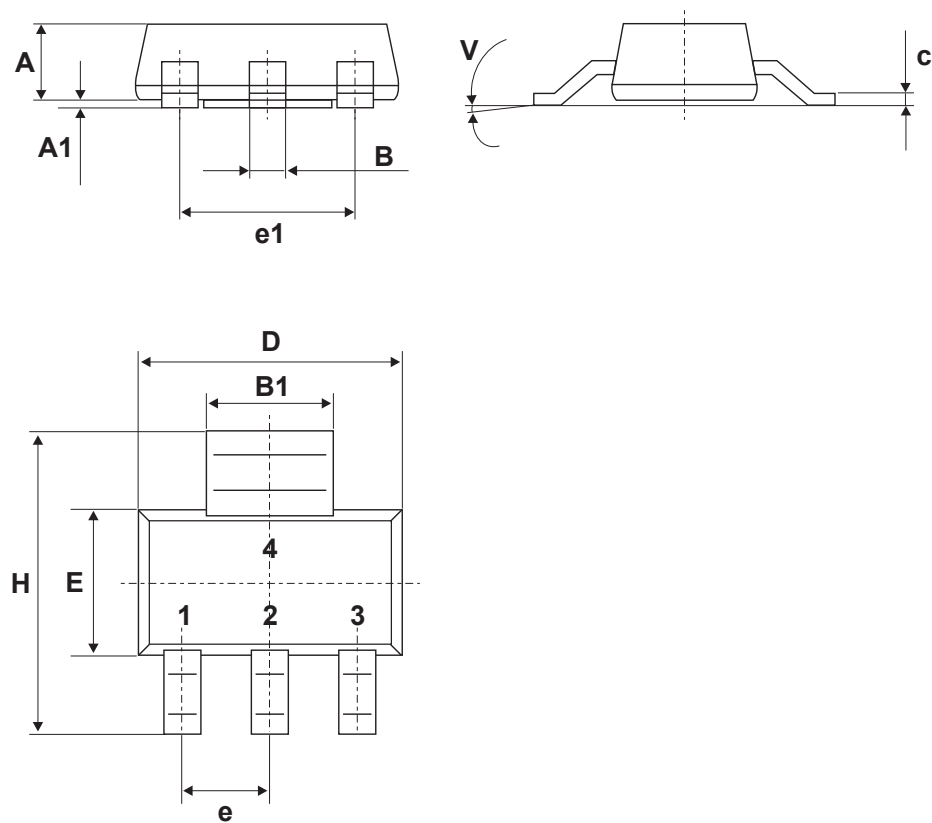
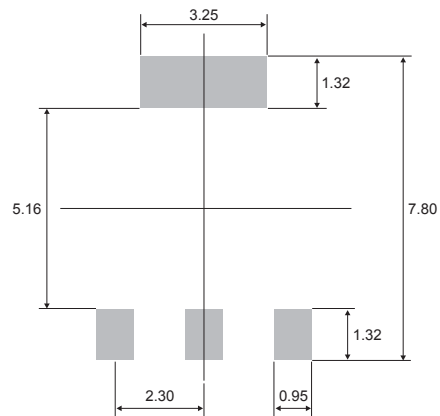

Table 5. SOT-223 package mechanical data

Ref.	Dimensions					
	Millimeters			Inches ⁽¹⁾		
	Min.	Typ.	Max.	Min.	Typ.	Max.
A			1.80			0.0709
A1		0.02	0.10		0.0008	0.0039
B	0.60	0.70	0.85	0.024	0.0276	0.0335
B1	2.90	3.00	3.15	0.114	0.1181	0.1240
c	0.24	0.26	0.35	0.009	0.0102	0.0138
D	6.30	6.50	6.70	0.248	0.2559	0.2638
e		2.3			0.0906	
e1		4.6			0.1811	
E	3.30	3.50	3.70	0.130	0.1378	0.1457
H	6.70	7.00	7.30	0.264	0.2756	0.2874
V	10° max.					

1. Inches only for reference

Figure 15. SOT-223 footprint (dimensions in mm)



2.2 TO-92 package information

- Lead free plating + halogen-free molding resin
- Epoxy meets UL94, V0

Figure 16. TO-92 package outline

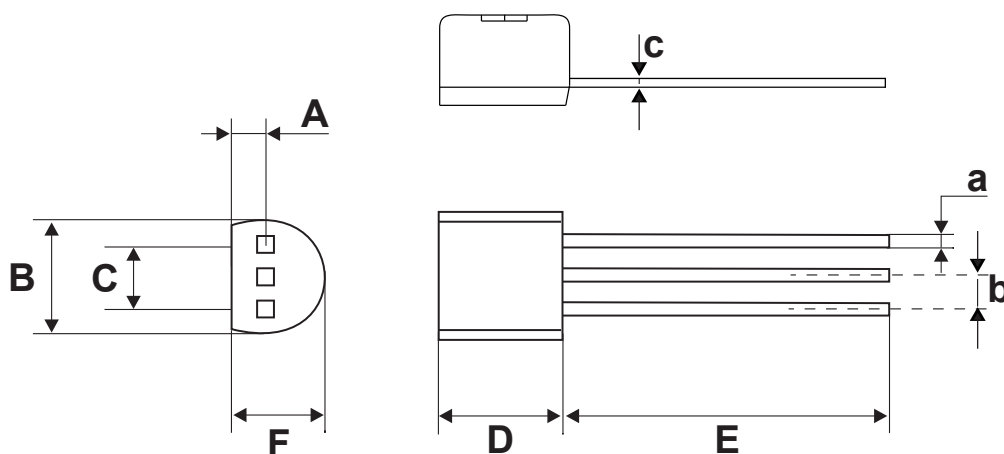

Table 6. TO-92 package mechanical data

Ref.	Dimensions					
	Millimeters			Inches ⁽¹⁾		
	Min.	Typ.	Max.	Min.	Typ.	Max.
A		1.35			0.0531	
B			4.70			0.1850
C		2.54			0.1000	
D	4.40			0.1732		
E	12.70			0.5000		
F			3.70			0.1457
a			0.50			0.0197
b		1.27			0.0500	
c			0.48			0.0189

1. Inches dimensions given for information

2.3 SMBflat-3L package information

- Epoxy meets UL94, V0
- Lead-free package

Figure 17. SMBflat-3L package outline

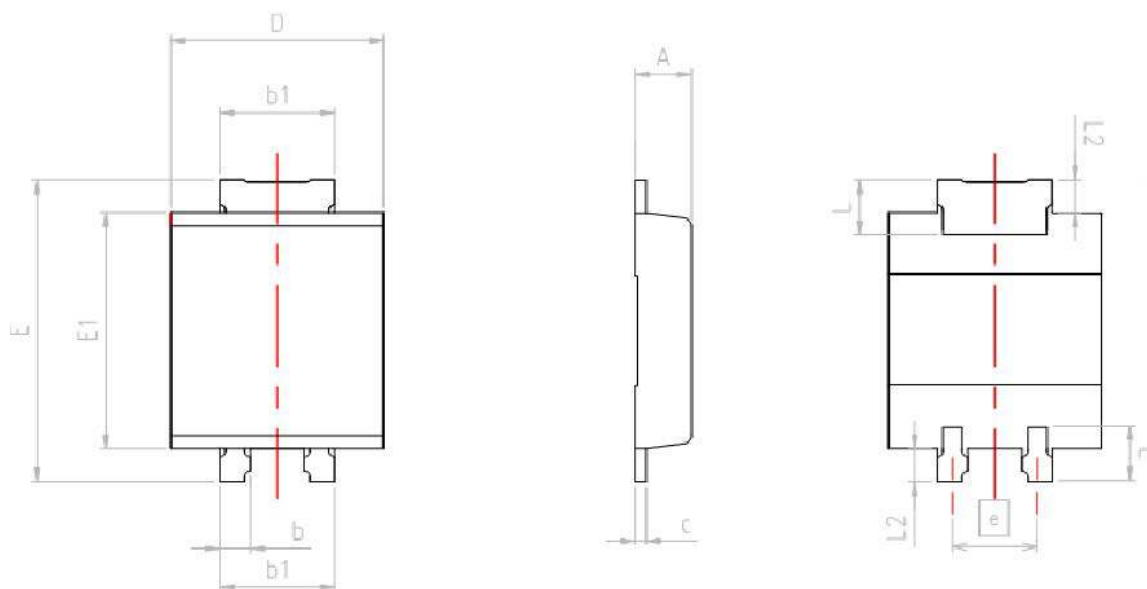

Note: This package drawing may slightly differ from the physical package. However, all the specified dimensions in the following table are guaranteed.

Table 7. SMBflat-3L mechanical data

Ref.	Dimensions					
	Millimeters			Inches (dimensions are for reference only)		
	Min.	Typ.	Max.	Min.	Typ.	Max.
A	0.90		1.10	0.0354		0.0433
b	0.35		0.65	0.0138		0.0256
b1	1.95		2.20	0.0768		0.0866
c	0.15		0.40	0.0059		0.0157
D	3.30		3.95	0.1299		0.1555
E	5.10		5.60	0.2008		0.2205
E1	4.05		4.60	0.1594		0.1811
L	0.75		1.50	0.0295		0.0591
L2		0.60			0.0236	
e		1.60			0.0630	

Figure 18. Footprint recommendations, dimensions in mm (inches)

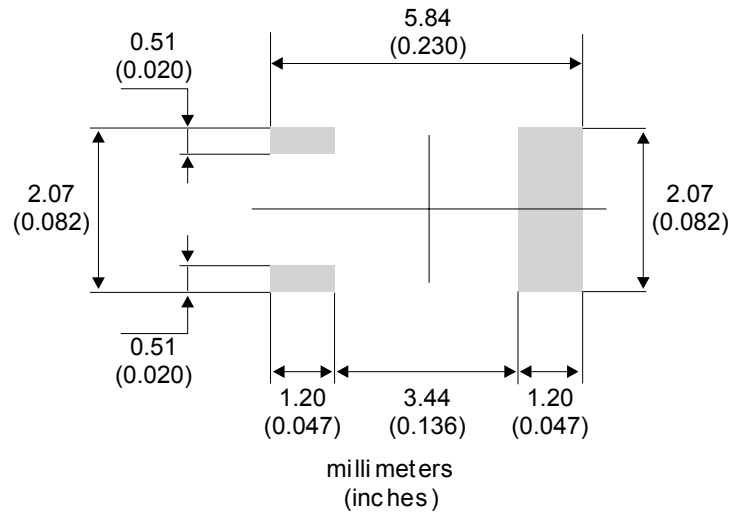

Note: This drawing may not be in scale; however, all the specified dimensions are guaranteed.

3 Ordering information

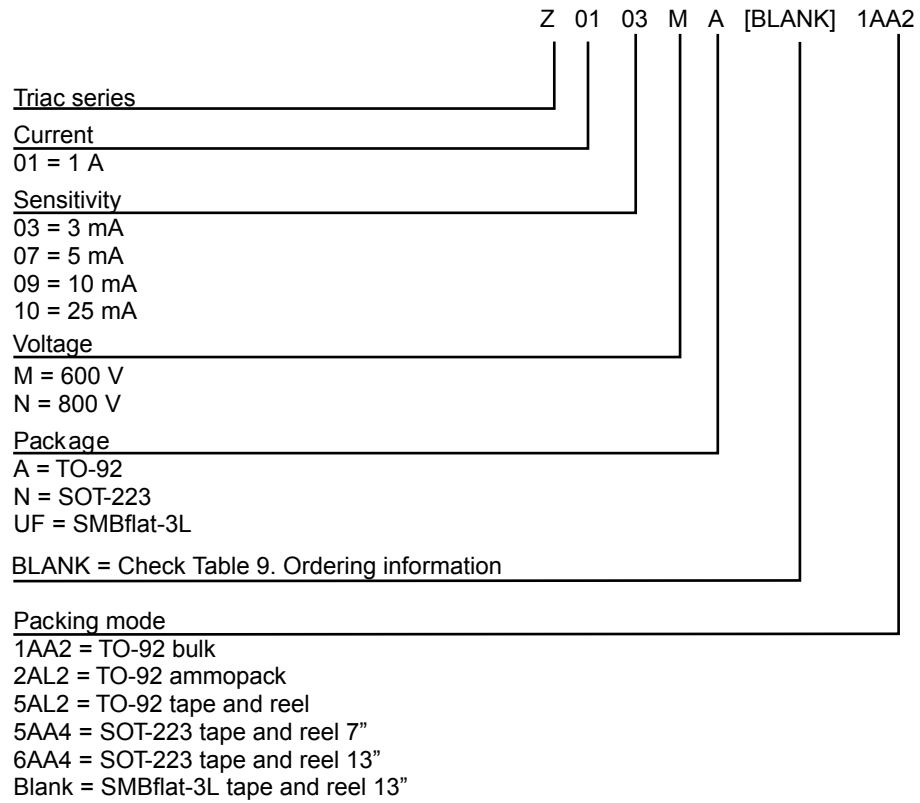
Figure 19. Ordering information scheme

3.1 Product selector

Table 8. Product selector

Part Number		Sensitivity	Type	Package
600	800			
Z0103MA	Z0103NA	3 mA	Standard	TO-92
Z0103MN	Z0103NN			SOT-223
Z0107MA	Z0107NA	5 mA		TO-92
Z0107MN	Z0107NN			SOT-223
Z0109MA	Z0109NA	10 mA		TO-92
Z0109MN	Z0109NN			SOT-223
Z0110MA	Z0110NA	25 mA		TO-92
Z0110MN	Z0110NN			SOT-223
Z0103MUF		3 mA		SMBflat-3L
Z0107MUF		5 mA		
Z0109MUF		10 mA		

3.2 Ordering information

Table 9. Ordering information

Order code ⁽¹⁾	Marking ⁽¹⁾	Package	Weight	Base qty.	Delivery mode		
Z01xxyA 1AA2	Z01xxyA	TO-92	0.2 g	2500	Bulk		
Z01xxyA 2AL2				2000	Ammopack		
Z01xxyA 5AL2				2000	Tape and reel		
Z0103yN 5AA4	Z3y	SOT-223	0.12 g	1000			
Z0103MN 6AA4	Z3M			4000			
Z0107yN 5AA4	Z7y			1000			
Z0107MN 6AA4	Z7M			4000			
Z0109yN 5AA4	Z9y			1000			
Z0109NN6AA4	Z9N			4000			
Z0103MUF	Z3M			SMBflat-3L		47 mg	5000
Z0107MUF	Z7M						5000
Z0109MUF	Z9M				5000		

1. xx = sensitive, y = voltage, and check Figure 19. Ordering information scheme.

Revision history

Table 10. Document revision history

Date	Revision	Changes
Oct-2001	4	Last update.
10-Feb-2005	5	Package: TO-92 tape and reel delivery mode 5AL2 added.
09-May-2005	6	Table 4 on page 2: typo. mistake corrected 1. (dV/dt)c instead of (dI/dt)c 2. V/μs unit instead of A/ms
21-Apr-2006	7	Reformatted to current standard. Table 2 on page 2: Typo corrected. Values for IGT split into two separate rows.
10-Oct-2010	8	Table 2: modified test conditions for (dV/dt)c. Changed “ambient” to “lead or tab” in Figure 2.
20-Oct-2010	9	Package: SOT-223 13” tape and reel added = 6AA4.
14-Dec-2010	10	Added package SMBflat-3L. Updated dimensions in Table 6. Updated Figure 3 and Figure 12. Updated Table 5: Product Selector.
02-May-2019	11	Updated Table 9. Ordering information. Minor text changed.
11-Apr-2023	12	Updated Figure 17 and Table 7.
19-Jul-2023	13	Updated Table 9.

IMPORTANT NOTICE – READ CAREFULLY

STMicroelectronics NV and its subsidiaries (“ST”) reserve the right to make changes, corrections, enhancements, modifications, and improvements to ST products and/or to this document at any time without notice. Purchasers should obtain the latest relevant information on ST products before placing orders. ST products are sold pursuant to ST’s terms and conditions of sale in place at the time of order acknowledgment.

Purchasers are solely responsible for the choice, selection, and use of ST products and ST assumes no liability for application assistance or the design of purchasers’ products.

No license, express or implied, to any intellectual property right is granted by ST herein.

Resale of ST products with provisions different from the information set forth herein shall void any warranty granted by ST for such product.

ST and the ST logo are trademarks of ST. For additional information about ST trademarks, refer to www.st.com/trademarks. All other product or service names are the property of their respective owners.

Information in this document supersedes and replaces information previously supplied in any prior versions of this document.

© 2023 STMicroelectronics – All rights reserved