

ITEM	Q'TY	PART NUMBER	PART DESCRIPTION
1	1	R5XX	2x5mm Rectangular LED, See Page 2
2	1	RL2-XXX	Molded Rectangular LED Mount

REV.	DESCRIPTION	DATE	APPROVED
B	Engineering Update w/o Changes	03/01/04	M. C.
C	Updated Specs.	04/02/08	M. C.
D	Engineering Update w/o Changes	06/25/16	J. C.

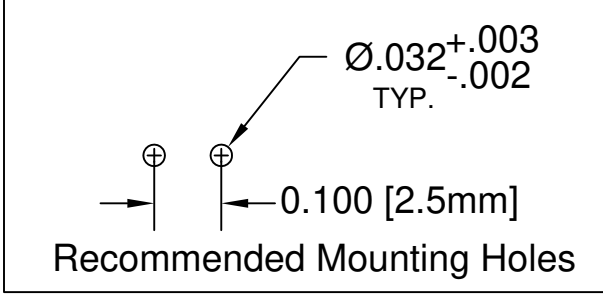
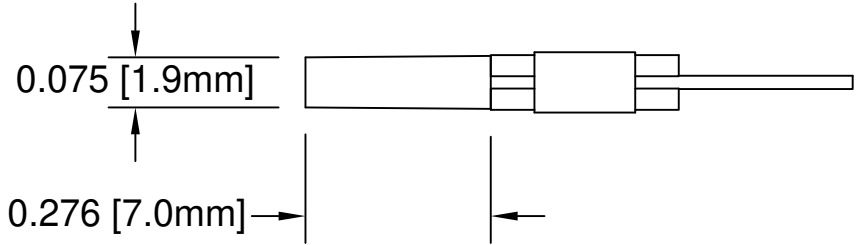
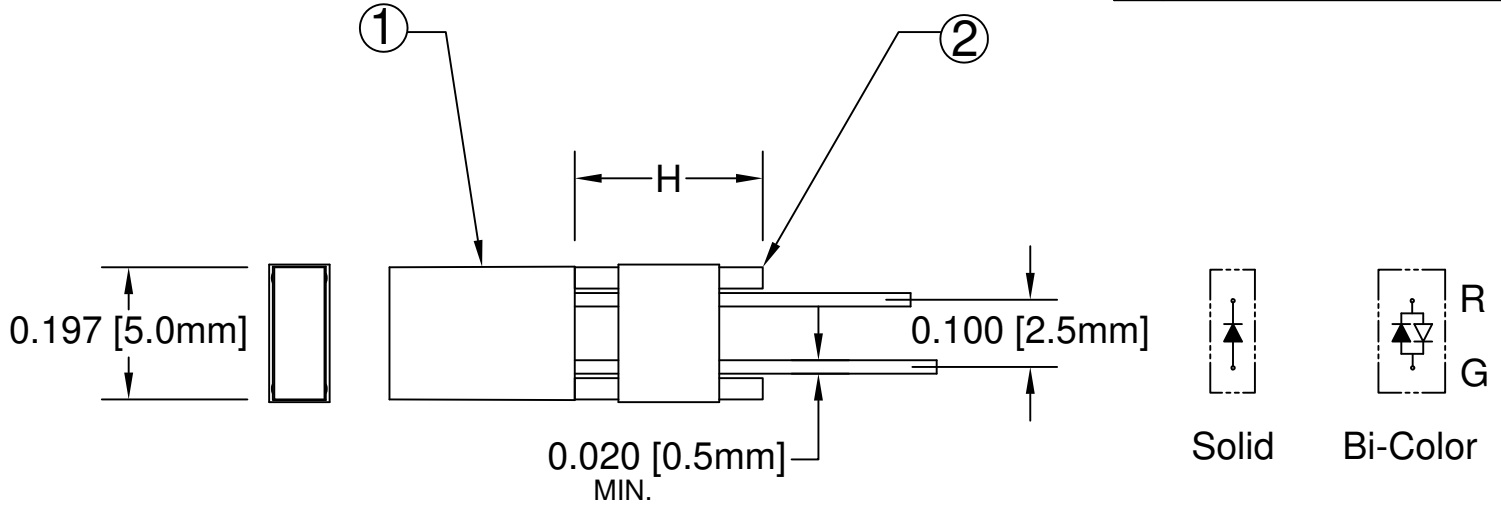

EXAMPLE:
RL21605GD(T)
 RL - Series
 216 - Height "H" *
 05 - LED Color & Lens Appearance.
 G - Optional Tape and Reel
 D - Omit R when ordering.

* XXX = Height "H"
 Available Range From 0.200" ~ 0.350"
 In 0.010" Increments

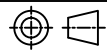

ABSOLUTE MAXIMUM RATINGS (Ta=25°C)

REVERSE VOLTAGE _____	5V
REVERSE CURRENT _____	100uA
OPERATING TEMPERATURE RANGE _____	-20° C - 80° C
STORAGE TEMPERATURE _____	-20° C - 80° C
LEAD SOLDERING TEMPERATURE(1/16" FROM BODY) _____	260° C FOR 5 SECONDS

STANDARD TOLERANCE (UNLESS OTHERWISE SPECIFIED)		 4 THOMAS, IRVINE, CA. 92618 TEL: (949) 951-8808 FAX: (949) 951-3974	
DECIMALS	ANGULAR		
.X ± .1	X° ± 1°	 TITLE: MOLDED RECTANGULAR LED MOUNT ASSEMBLY	
.XX ± .02			
.XXX ± .010			
DESIGNED: T. Yin	DATE: 03/01/04	PART NO: RL2XXX5XX	REVISION: D
CHECKED: D. Green	DATE: 03/01/04	CAGE CODE : 32559	SHEET # 1 OF 2
CAD GENERATED DOCUMENT. DO NOT MEASURE DRAWING.			

REV.	DESCRIPTION	DATE	APPROVED
	SEE SHEET #1		

LED Assy P/N	Peak Wavelength λ_p (nm)	Emitted Color	Lens Appearance	Abs. Max. Rating	LED Electro-Optical Data @ 20mA			Viewing Angle $2\theta_{1/2}$ (Deg)	LED P/N
					Vf (V)		Iv (mcd)		
				If (mA)	TYP	MAX	TYP		
RL2XXX5GD	568	GREEN	DIFFUSED	30	2.2	2.6	7.0	125	R5GD
RL2XXX5YD	585	YELLOW	DIFFUSED	30	2.1	2.6	5.0	125	R5YD
RL2XXX5RD	655	RED	DIFFUSED	40	1.7	2.0	0.8	125	R5RD
RL2XXX5BC	635	HE RED	WHITE	45	2.0	2.6	4.0	125	R5BC
	568	GREEN	DIFFUSED	30	2.2	2.6	4.0		

STANDARD TOLERANCE (UNLESS OTHERWISE SPECIFIED) $\pm 10\%$ ALL VALUES ANGULAR		 4 THOMAS, IRVINE, CA. 92618 TEL: (949) 951-8808 FAX: (949) 951-3974	
		 TITLE: MOLDED RECTANGULAR LED MOUNT ASSEMBLY	
DESIGNED: T. Yin	DATE: 03/01/04	PART NO: RL2XXX5XX	REVISION: D
CHECKED: D. Green	DATE: 03/01/04	CAGE CODE : 32559	SHEET # 2 OF 2
CAD GENERATED DOCUMENT. DO NOT MEASURE DRAWING.			