

EMOSAFE EN-66

Network Isolators with Cable

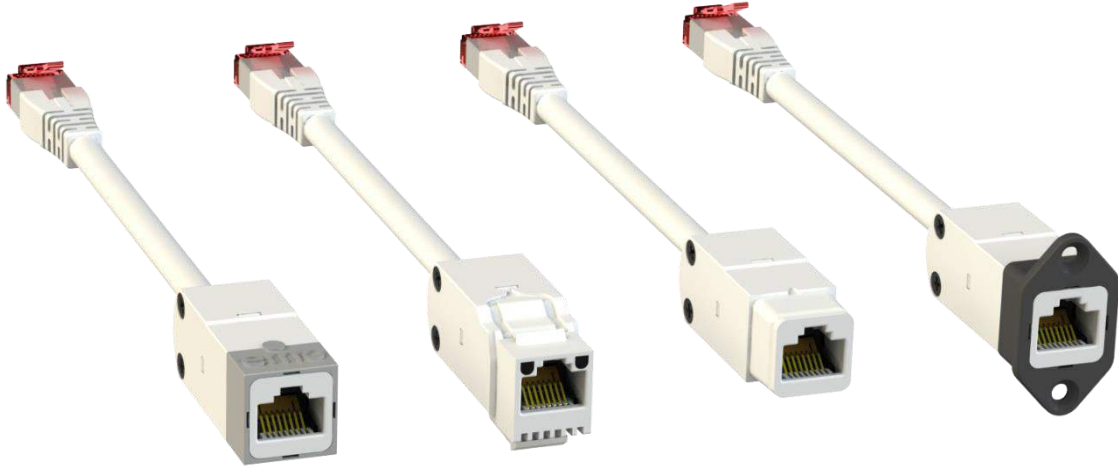

EN-66e, EN-66K, EN-66S and EN-66S mit Z-4-SF-EXT

1 FEATURES AND ADVANTAGES

- Available with Keystone or SnapFit interface
- SnapFit accessories available for panel mounting
- 5.0 kV AC dielectric strength
- 8.5 kV DC dielectric strength
- Suitable for installation into devices and racks
- Suitable for use within medical devices
- Designed and tested to meet IEC 60601-1
- UL Recognized Component
- High Performance 10Gigabit Ethernet
- ISO/IEC 11801 Class E_A as well as TIA/EIA-568 Cat 6A Ethernet Performance in Channel Links
- Extremely low insertion losses; allowing total cable lengths of 100 meters
- 100% inspection by our Quality Control
- Available in various cable stub lengths
- Suitable for devices with supply voltages up to 400 V AC
- RoHS compliant

2 GENERAL DESCRIPTION

The EMOSAFE EN-66 Network Isolator galvanically isolates every conductor (specifically the data and shield conductors) between devices connected via a copper-based Ethernet network. The Network Isolator prevents current flow resulting from differences in electrical potentials, and also protects connected devices and their users from stray external voltages and power surges which may be directly or inductively

coupled onto the network lines by causes such as installation errors, lightning, switching operations, and electrostatic discharge.

Built into a medical electrical (ME) product, the EMOSAFE EN-66 Network Isolator facilitates the safe Ethernet connection of this ME product within the patient environment. The EN-66 satisfies all construction requirements of IEC 60601-1 in the formation of two means of patient protection (MOPP) within the network interface, thereby practically eliminating the risk of electrical shocks arising from such stray external voltages at the network connection. With its UL approval, the EN-66 is also suitable for devices destined for export to the North American markets.

The EMOSAFE EN-66 is an efficient and compact 10Gigabit Ethernet network isolator, characterised by exceptional Ethernet performance and a very high dielectric withstanding voltage. As a Keystone module, it can be used in all Keystone-compatible outlet sockets, patch panels, and panel cut-outs. The construction with socket and cable stub provides the physical functionality of an extension cable.

Low-frequency signal components are strongly attenuated, protecting connected devices from ground loops.

The EMOSAFE EN-66 Network Isolator transmits high-frequency signals through the principle of electromagnetic induction. This results in the EN-66 not requiring any external power supply. There are no software drivers to be installed.

3 APPLICATIONS

3.1 PATIENT PROTECTION

Electrical separation of Ethernet interfaces of medical electrical (ME) devices and systems, where patients must be protected from dangerous leakage currents, in conformity with applicable standards.

3.2 EQUIPMENT PROTECTION

Applications, in which valuable or critical devices or those requiring special protection need to be protected against ripple, mains hum, and surge voltages from the network periphery.

3.3 MEASUREMENT TECHNOLOGY

Electrical measuring and monitoring equipment, which needs to be protected against external and interference voltages arising from the application environment.





3.4 POTENTIAL DIFFERENCES (TECHNICAL BUILDING SYSTEMS)

Computer systems, which are electrically connected with each other over significant distances via Ethernet cabling, where current flows caused by potential differences must be prevented.

4 SUMMARY OF VARIANTS

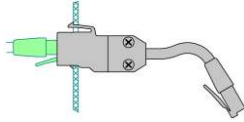
EN-66

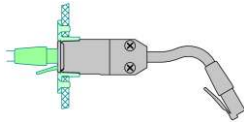
Installation Network Iso-lator with Cable

	Name Article number	Special features	AC dielectric strength (kV)	IEC 60601-1	100/1000/10000 Mbit/s	Configuration
Keystone 	EN-66K A10076	For use in Key-stone-compatible outlets.	5.0	✓	✓	
SnapFit 	EN-66S A10075	For use with EMOSAFE SnapFit accessories.	5.0	✓	✓	
Standalone 	EN-66e A10074	For easy upgrade of existing equipment.	5.0	✓	✓	

5 TECHNICAL DRAWINGS

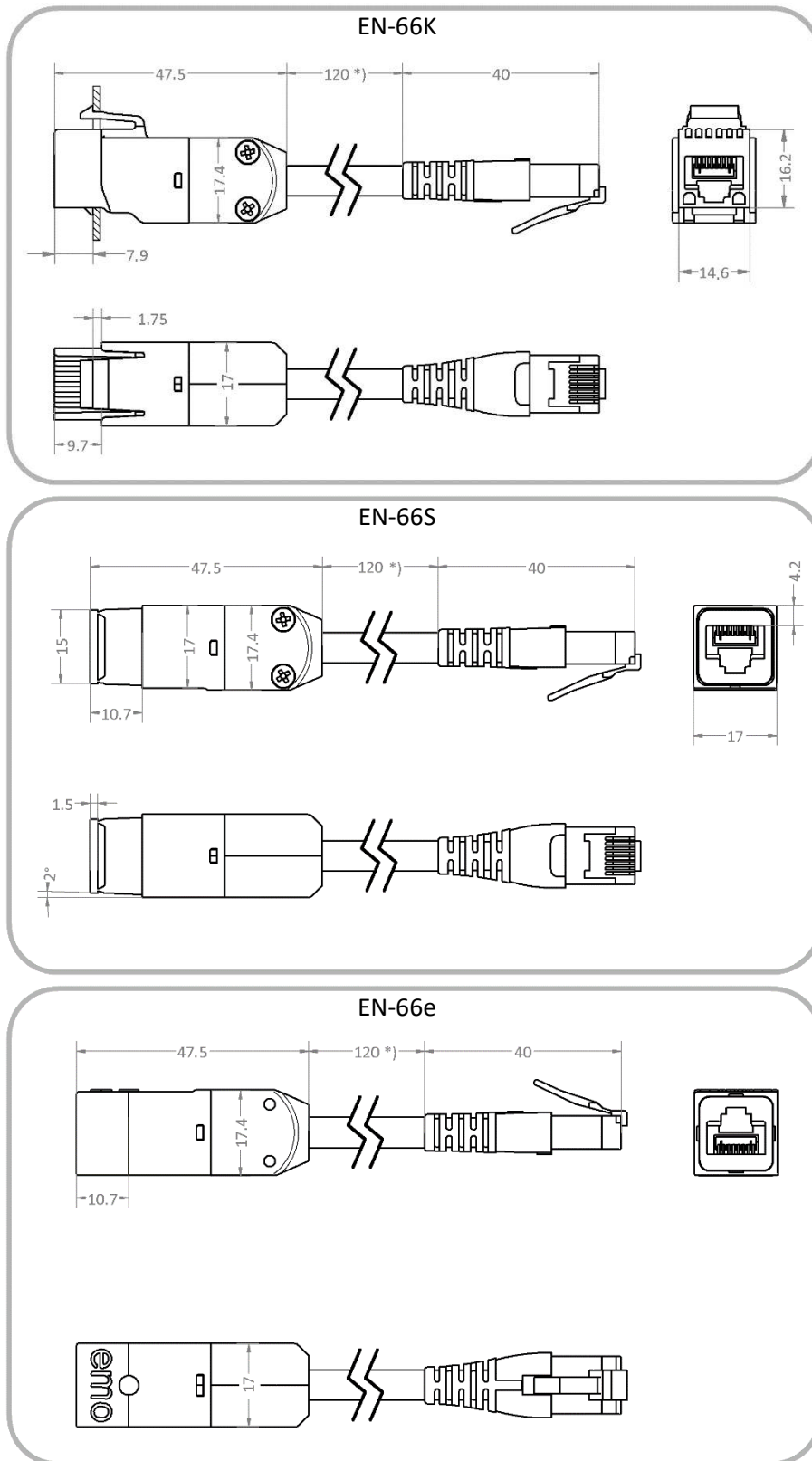





Figure 1 Technical drawings for EN-66. All dimensions are in millimetres.
 *) Standard cable length of 200 mm. A selection of other cable lengths from 30 mm to 10 m are available upon request.

6 ACCESSORIES

6.1 OVERVIEW

SnapFit

Installation frames for SnapFit variants

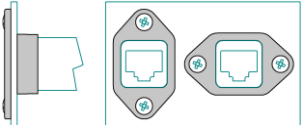
	Name	Special features	Configuration
	Z-3-SF-INT A10057	<ul style="list-style-type: none"> Housing assembly for flush mounting Two snap-fit positions Material: polyamide, black Two M2.5 brass inserts 	
	Z-4-SF-EXT A10058	<ul style="list-style-type: none"> Protruding housing assembly Two snap-fit positions Material: polyamide, black 	

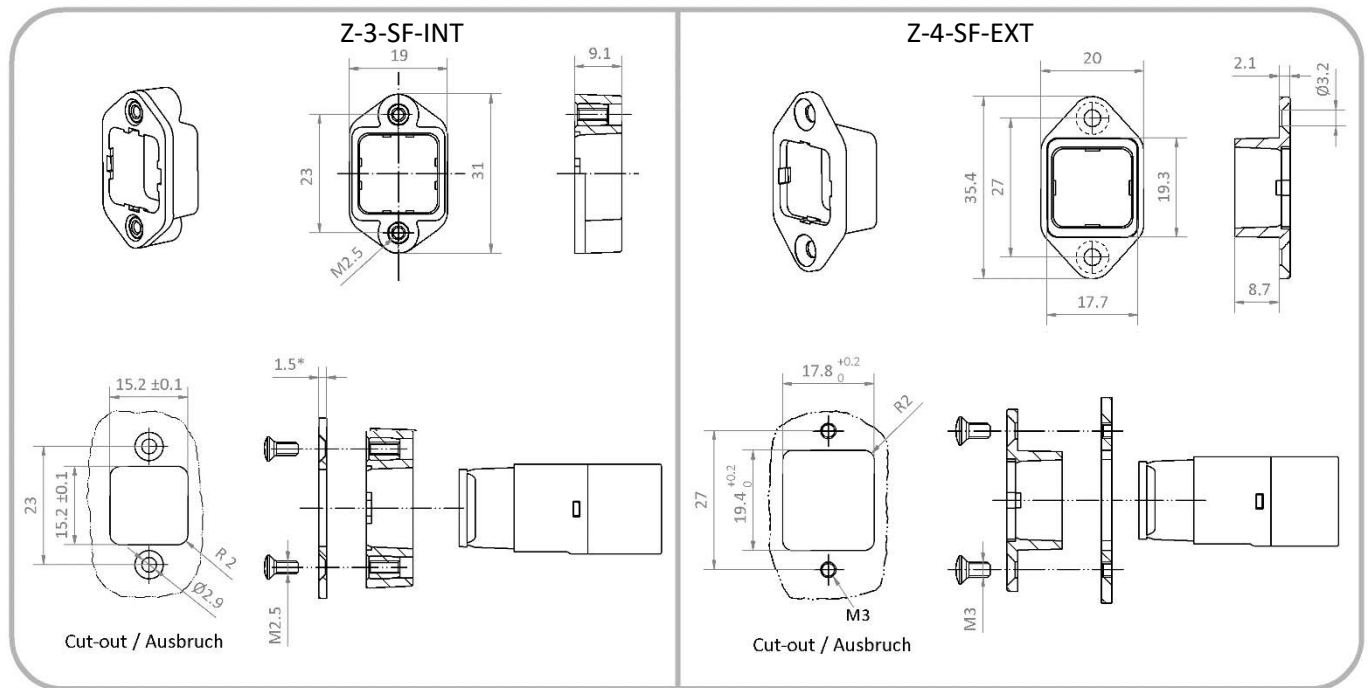

Figure 2 Physical dimensions and required cut-out for SnapFit installation frames. All dimensions are in millimetres.
* 1.5mm is recommended for a flush surface mounting. Other plate thicknesses are possible.

7 INSTALLATION

Network Isolators may only be connected to an Ethernet network via components that comply with either EN 62368-1/ VDE 0868-1 (Information technology equipment) or IEC 60601-1 (Medical electrical equipment).

7.1 EN-66K

The Network Isolator EN-66K can be snapped into any housing aperture which corresponds to the Keystone dimension requirements shown in Figure 1. It is therefore compatible with many wall outlets and rack systems from various manufacturers and is especially suitable for use within cable ducts and medical supply units.

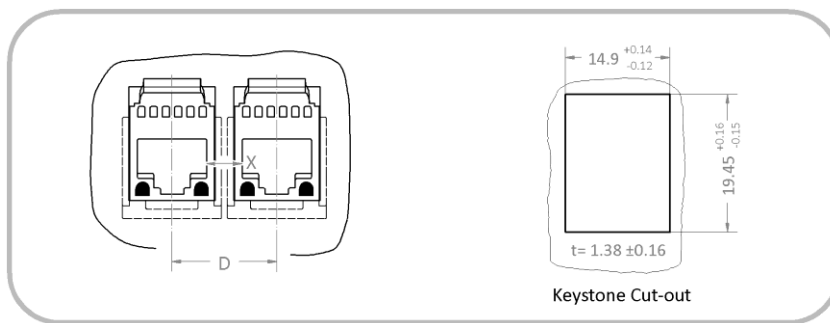

Figure 3 Dimensions for Keystone-compatible cut-outs.

Figure 4 shows a typical assembly within a cable duct (10), with cover (11). The Network Isolator EN-66K (1) is shown installed in a Keystone-compatible wall outlet, which usually consists of a support frame (5) and a plastic front panel (4). The RJ45 plug (3) of the Network Isolator is to be inserted into a RJ45 jack module termination (7) at the end of the permanently installed data cable (8). When retrofitting the Network Isolator EN-66K (1) into network channels, the existing RJ45 jack module from the wall outlet can be shifted back within the cable duct (10) and used as the connection to the Network Isolator.

The interface at the RJ45 jack module (7) between the permanently installed cable and the Network Isolator must be kept accessible if regular safety checks are to be conducted, or if the ability to subsequently verify the permanent installation is required. If this is not already made possible by a removable duct cover (11), we recommend the installation of a service access panel (6).

The EN-66K Network Isolator also interrupts the shield connection. Should the cable shield of the permanently installed network cable (8) need to be connected with the room or equipment potential, this must occur at the shifted-back RJ45 jack module (7), i.e. with the help of an earthing wire (9).

Permanent tensile loading on the connecting cable (2) is not permitted.

If it is intended that two or more EN-66K Network Isolators will be installed side by side into multiple module carriers, the mounting distance "D" in Figure 3 must be taken into account. Crucial to this is the creepage distance across the dimension "X" in Figure 3, between the shield plates of the inserted RJ45 plugs.

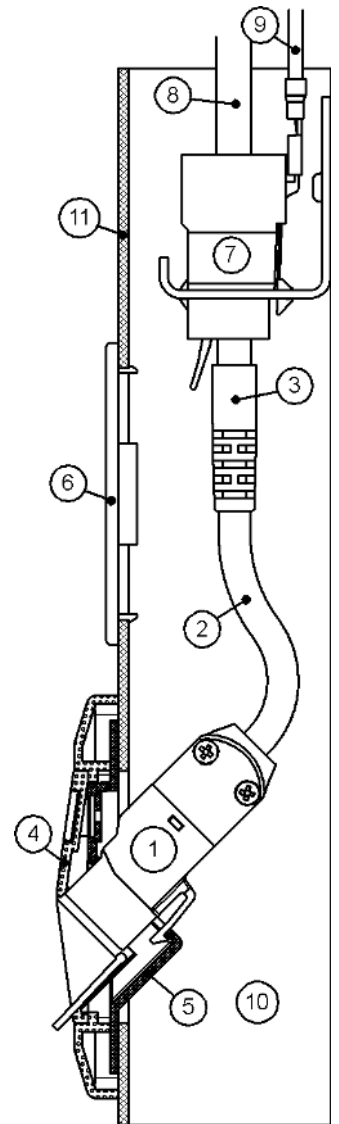

Figure 4 Keystone network isolator in a cable duct

The resulting creepage distance must not fall short of 8 mm (250 V AC), or 12 mm (400 V AC), as appropriate for the voltage scenario. The center-to-center distance "D" can however be reduced, if the creepage distance across the dimension "X" is increased accordingly (e.g. by adding plastic dividers). Combining EMOSAFE Network Isolators and non-galvanically isolated Keystone modules within module carriers is not recommended.

7.2 EN-66S

The EN-66S Network Isolator is intended for incorporation into electronic devices, and it provides a Snap-Fit interface for this purpose. An example configuration is shown in Figure 5.

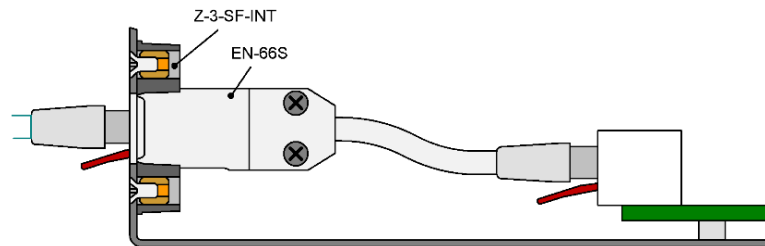

Figure 5 Example configuration of the EN-66S installed in combination with the Snap-Fit accessory Z-3-SF-INT.

SnapFit installation frames are available as accessories for the EN-66S; providing panel mounting which is secure and free from play. The physically square interface allows for four different attachment positions. The production of customer specific SnapFit frames is possible upon request.

ATTENTION: *SnapFit installation frames are no longer removable after being snapped into place. Therefore please pay attention to the correct plug-in position when assembling!*

7.3 EN-66e

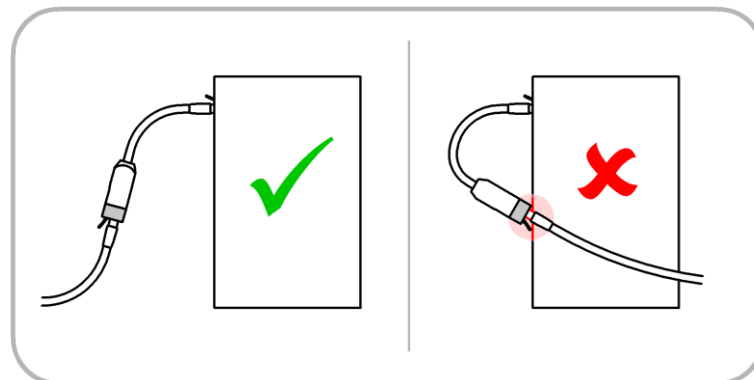

Figure 6 Via the not isolated ending of a patch cable and the metal housing of a termination device, the ground isolation of the network isolator can be accidentally bypassed.

The EN-66e can be used for an easy retrofit existing equipment. For best speed performance and maximal protection, the network isolator should be placed as close as possible to the device which is supposed to be protected.

Care must be taken with cable routing in the application. By placing the isolator close to the end device with conductive areas and using a patch cable with a large ground connection, the ground isolation of the network isolator may accidentally be bypassed (see Figure 6)

7.4 POWER OVER ETHERNET

The EN-66 Network Isolator can be used in a Power over Ethernet (PoE) network without restriction (however PoE devices downstream of the electrical isolation are not supplied with power).

8 SAFETY NOTICE

8.1 ASSEMBLY

During design and assembly into medical electrical systems, attention should be paid to clearance and creepage distances, to ensure that the distances required by IEC 60601-1 are met. The isolating effect of the Network Isolator must not be compromised by neighbouring conductive components. If, for example, the installation of the Network Isolator is to be within a metal plate, this plate must be connected to the ground potential (protective earth).

The EN-66 Network Isolator should always terminate a cable route. Installations that are set back within cable ducts, as well as installations in remote patch panels, are not recommended because the protective properties of the Network Isolator are guaranteed only directly at its own RJ45 output.

8.2 ENCLOSURE AND CONNECTION AREAS

The Network Isolator provides excellent protection between input and output, however the plastic enclosure provides only basic isolation. Furthermore, the connected plugs and the areas around the receptacles may have metal surfaces accessible to human contact, and therefore provide no protection. If the risk management process of the responsible organization (i.e. manufacturer or operator, as defined in IEC 60601-1) reveals unacceptable risks that operators or patients can touch the housing or exposed conducting parts while the Ethernet cabling is connected to a potentially dangerous voltage, the Network Isolator and the exposed conducting surfaces must be surrounded with an appropriate enclosure to ensure the required means of protection for the application.

8.3 DAMAGE AND CONTAMINATION

Damaged Network Isolators, and Network Isolators which are contaminated by dust or liquids, are to be replaced.

9 SAFETY AND FUNCTION TESTING

9.1 FUNCTION AND COMPLIANCE TESTING

The transmission properties of permanent network installations fitted with EN-66 Network Isolators can be checked with cable certification devices which are suitable for testing electrically isolated cable sections. To be able to conduct such an inspection, the test equipment must be configured in an AC wire-map mode. The entire cable route, including the Network Isolator, can be tested to TIA/EIA-568 Cat 6A or ISO 11801 Class E_A as a Channel-Link. Testing of the cable shielding and the conductor resistance is not possible in this mode. If however, these tests are required, or if the quality of the cable route itself needs to be tested (without the Network Isolator), then testing can be performed by bypassing the Network Isolator, and connecting directly to the RJ45 socket ⑦, set back within the cable duct, as indicated in Figure 4.

9.2 SAFETY INSPECTIONS

Regular safety inspections and post-repair inspections are not prescribed for network isolators in medical use, as network isolators themselves are not classified as medical electrical (ME) devices. However, together with a connected medical device, network isolators form an ME system, which altogether may be subject to inspection. The test interval, as well as the requirements to be met for both regular safety inspections and post-repair inspections will be specified by the responsible organisation (i.e. manufacturer or operator, as defined in IEC 60601-1), and based upon the applicable standards for the entire ME system.

To simplify implementation, the system components (in this case, the network isolator) can be individually tested. The responsible organization provides the test parameters, specifies the test interval, and specifies the actions to take when a component fails the test. Such an assessment may, depending upon requirements, include the following checks:

9.2.1 VISUAL INSPECTION

Check for evidence of external damage and ingress of substances, dust or liquids for example.

9.2.2 LEAKAGE CURRENT TEST

The leakage current is to be measured, to ensure that it falls within the prescribed limits. For this purpose, test equipment which can perform equipment leakage current measurements in accordance with IEC 62353 may be used. To perform a leakage current test, all conductors on the input side must be short-circuited together, and all the conductors on the output side must also be short-circuited together. The AC test voltage specified by the responsible organisation is then applied across these two connections. Input and output sides are interchangeable. The expected current flow can be found in section [11 SPECIFICATIONS](#).

9.2.3 HIPOT TEST

To ensure that the device under test is not damaged, it is recommended that a DC voltage source is used in place of the AC voltage source, and that the DC voltage is 1½ times that of the required AC voltage. The test setup is essentially the same as that of the Leakage Current Test above. The expected dielectric strength can be found in section [11 SPECIFICATIONS](#).

9.2.4 FUNCTIONAL TEST

After conducting the tests above, and reconnecting the Network Isolator into the network, an examination is recommended to ensure that the signal transmission is performing correctly. Such a functional test can be performed, for example, with a suitable Ethernet cable certification device. Refer to the section [9.1 FUNCTION AND COMPLIANCE TESTING](#).

10 MODEL OPTIONS AND ORDERING INFORMATION

10.1 NOTES

The length of the flexible cable stub ② (see Figure 4) of the EN-66 Network Isolator is available in selected lengths from 30 mm to 10 m (inclusive). Refer to Figure 7, as well as the table in section 10.3. It is recommended that this length be kept to a minimum. When compared to a fixed installed cable, this flexible cable stub may be more susceptible to near end crosstalk (NEXT) and alien crosstalk (AXT). The flexible cable stub itself generates a small, but length-dependent amount of insertion loss (IL).

For flexible cable stub lengths between 30 mm and 500 mm (inclusive), the plug angle can be chosen, easing mechanical constraints in certain assembly configurations, and removing impermissible torsion strains from the cable assembly. Refer to Figure 7. The manufacturing tolerance for the plug angle is $\pm 20^\circ$.

10.2 ANGLE CODES

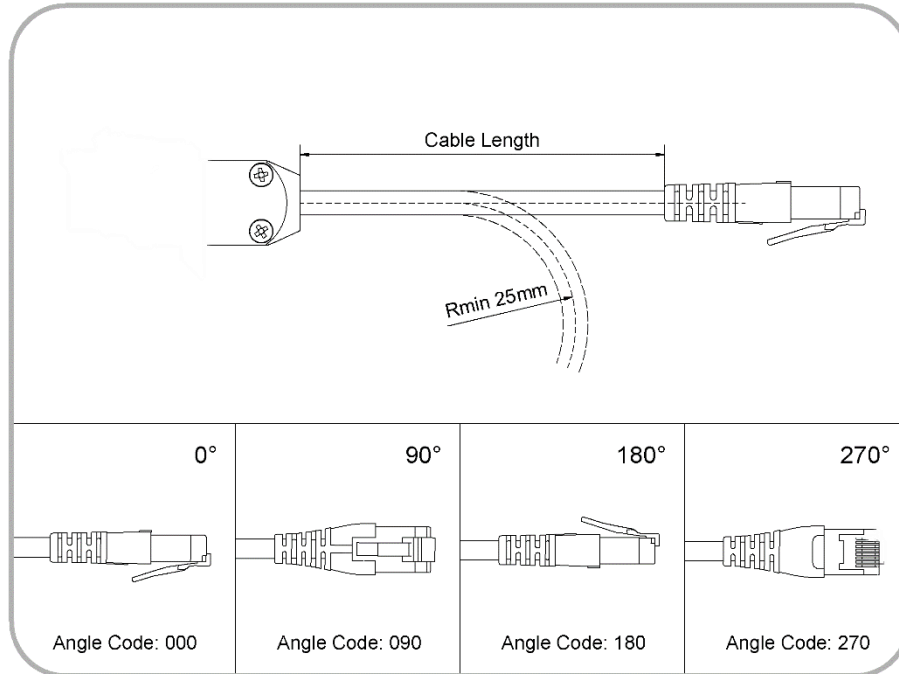

Figure 7. Cable length, as well as angle codes.

10.3 AVAILABLE CABLE LENGTHS

Length Groups	Step	Length Tolerance	Length Code
30, 40, ... 100 mm	10 mm	± 5 mm	00030 ... 00100
120, 140, ... 300 mm	20 mm	± 7 mm	00120 ... 00300
350, 400, ... 1000 mm	50 mm	± 15 mm	00350 ... 01000
1100, 1200, ... 3000 mm	100 mm	± 30 mm	01100 ... 03000
3500, 4000, ... 10000 mm	500 mm	± 50 mm	03500 ... 10000

10.4 ORDER NUMBERS

When placing orders for EN-66, please specify the exact Order Code (OC). The order number is a hyphenated concatenation of the Article Number (A10068 for EN-66K, or A10069 for EN-66S), the Length Code for the desired cable length (see section 10.3 above), and the Angle Code for the desired plug angle (see Figure 7). For flexible cable stub lengths greater than 500 mm, the EN-66 will always be manufactured with a plug angle of 0° , and the Angle Code can be omitted for such orders.

The following example shows the complete Order Code for an EN-66K with 400 mm cable length and a plug angle at 180° .

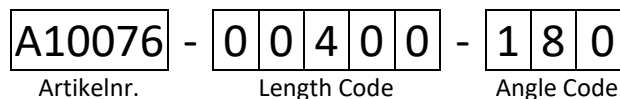

11 SPECIFICATIONS

11.1 GENERAL

Category	Standards or Test Criteria	Property
Designation		EMOSAFE EN-66K, EMOSAFE EN-66S, EMOSAFE EN-66e
Housing Color		White
Housing Material		Plastic
Construction		EN-66K: Keystone Module with Cable EN-66S: SnapFit Module with Cable EN-66e: Standalone Module with Cable
Cable Length	Flexible cable segment between plug and housing	Selected lengths between 30 mm and 10 m (inclusive). Refer to section 10.3
Minimum Bending Radius		25 mm
Maximum short-term loading upon cable		70 N for up to 10 s
Input Interface		RJ45 Jack, straight
Output Interface		RJ45 Plug, cable
Weight	with 200 mm cable length	approximately 26 g
Protection Rating	EN 60529	IP40
Mating Cycles:	RJ45 plug in RJ45 socket	> 1000 cycles
Mismatched: Mating Cycles:	with RJ11 / RJ12 / RJ25	maximum of 100 cycles
Mean Time To Failure (MTTF)	SN 29500 Standard Temperature: 25°C Duty cycle: 100% (24 hours, 7 days)	3,240 years
	SN 29500 Standard Temperature: 40°C Duty cycle: 100% (24 hours, 7 days)	3,070 years

11.2 ETHERNET PERFORMANCE

Category	Standards or Test Criteria	Property
Transmission Speeds and Supported Network Protocols	100 Mbit/s 100Base-T (IEEE802.3 Cl.25)	✓
	1000 Mbit/s 1000Base-T (IEEE802.3 Cl.25)	✓
	10 Gbit/s 10GBase-T (IEEE802.3 Cl.48)	✓
Performance Category	ISO/IEC 11801 Channel Link (CH), Class	Class E _A
	TIA/EIA-568 Channel Link (CH), Cat	Cat 6A

Depending on the measurement parameter, the Ethernet performance of a network component is not only dependent on the hardware component itself, but also on the transmission link in which it is installed. For this reason, the network isolators are evaluated using a realistic transmission link, the so-called Channel-Link. In order to offer maximum protection for the end device, we recommend the structure of Figure 8.

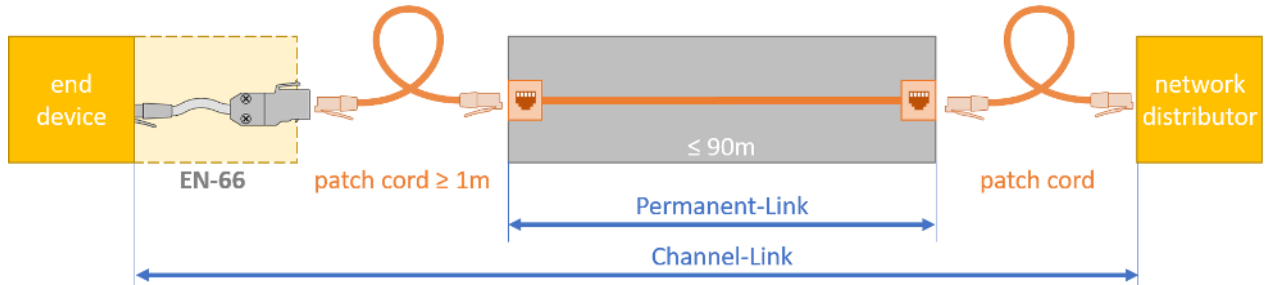

Figure 8 Recommended setup of the network isolator

The speed is classified, among other things, by adhering to limit values for the Insertion Loss (IL), the Return Loss (RL) and Near-End-Crosstalk (NEXT) of the system setup.

The IL is fundamentally additive and the individual IL portions of all components of the system structure can be added up. Figure 9 and Figure 10 show the IL of the network isolator without the remaining Channel-Link components. Figure 11 and Figure 12 show the RL and the NEXT performance of the recommended structure on the end device side. The RL and the NEXT depend strongly on the structure of the system and do not behave additively with the rest of the structure.

More detailed information on system setup, classifications, performance and the basics of the individual parameters can be found in our white paper "[Ethernet Performance of Network Isolators](#)".

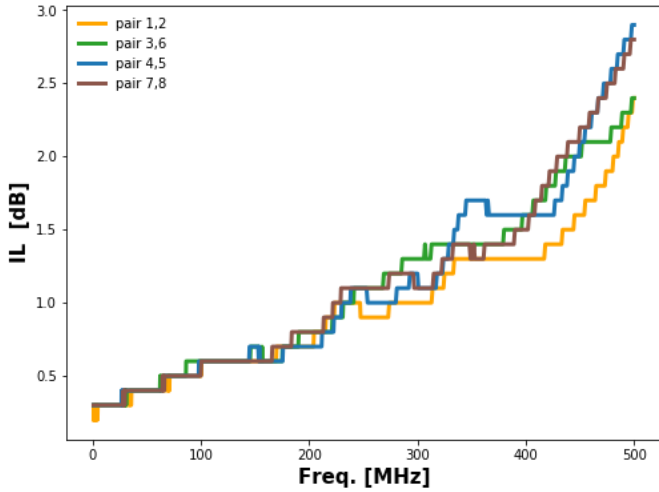

Figure 9 Insertion Loss of an EN-66

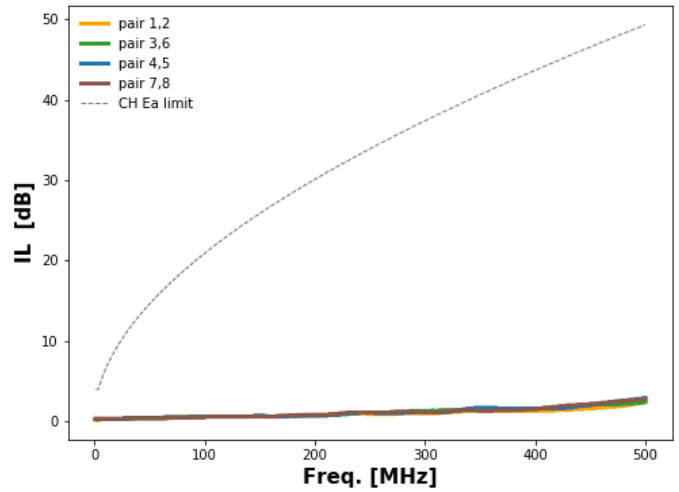

Figure 10 Insertion Loss of an EN-66 with the Class E_A Channel-Link Limit

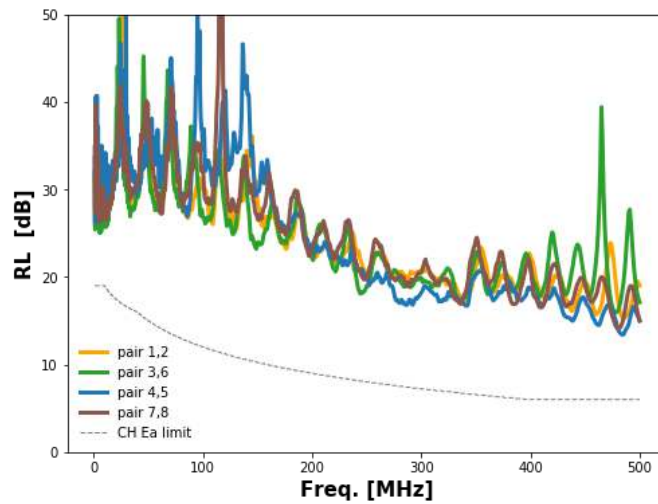

Figure 11 Return Loss of an EN-66 on the end device side of the setup of the recommended setup

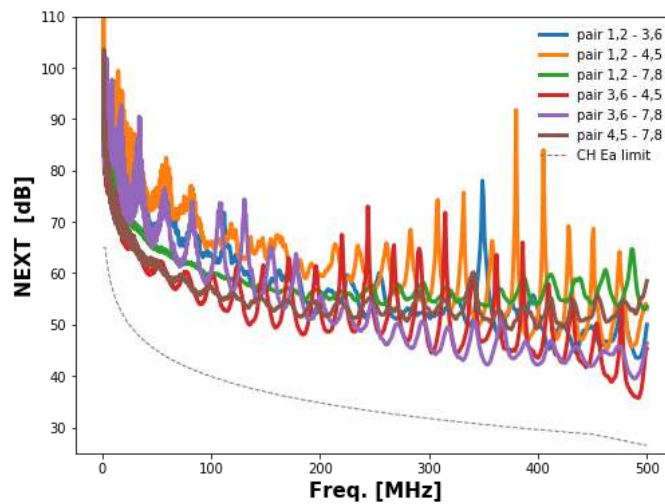

Figure 12 NEXT-Performance Loss of an EN-66 on the end device side of the setup of the recommended setup

11.3 ELECTRICAL

Category	Standards or Test Criteria		Property
AC Dielectric Strength	@ 50 Hz, for 60 s		5.0 kV
DC Dielectric Strength	for 60 s		8.5 kV
Reinforced Isolation	IEC 60601-1		✓
Coupling Capacitance / Channel			15 pF ±25%
Total Coupling Capacitance			60 pF ±25%
Total Leakage Current	275 V AC @ 50 Hz	Typical:	12.0 µA
		Maximum:	16.0 µA

11.4 OPERATING CONDITIONS AND AREA OF APPLICATION

Category	Standards or Test Criteria		Property
Pollution Degree	IEC 61010		2 ¹
Overvoltage Category	IEC 60664-1		III
Maximum Working Voltage ²	Maximum mains voltage of the connected devices, in accordance with IEC 60601-1		400 V AC 450 V DC
Temperature		Min.:	-10°C
		Max.:	+60°C
Air Humidity	Non-condensing	Min.:	10%
		Max.:	90%
Air Pressure		Min.:	700 hPa
		Max.:	1,060 hPa
Altitude		Max.:	3,200 m

¹ Normally only nonconductive pollution occurs. Temporary conductivity caused by condensation is to be expected.

² The Network Isolator can be permanently exposed to this voltage level.

11.5 ENVIRONMENTAL CONDITIONS: STORAGE AND TRANSPORTATION

Category	Standards or Test Criteria		Property
Temperature		Min.:	-40°C
		Max.:	+70°C
Air Humidity	Non-condensing	Min.:	10%
		Max.:	90%
Air Pressure		Min.:	500 hPa
		Max.:	1,060 hPa

11.6 CERTIFICATES

Category	Property
UL Recognized Component	✓
UL File No.	E362969
IEC 60601-1	✓
IEC 60601-1-2	✓
ANSI/AAMI ES 60601-1	✓
CAN/CSA-C22.2 No. 60601-1	✓
Low Voltage Directive	✓
EMC Directive	✓
RoHS Directive	✓

The versions of the cited standards and directives to which our products comply with can be found in our Declaration of Conformity and our UL certificate on our website under "[Standard Conformity and Certificates](#)".

11.7 ISOLATION DIAGRAM

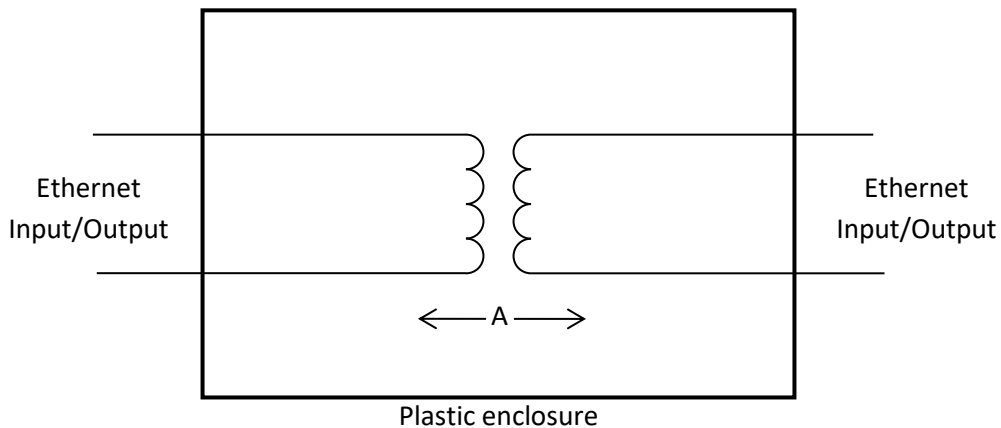

Figure 13. Isolation diagram for EN-66

Area	Number and type of Means of Protection	Material Group (from CTI)	Maximum Operating Voltage		Required creepage distance (mm)	Required clearance distance (mm)	Measured creepage distance (mm)	Measured clearance distance (mm)
			V AC	V _{peak}				
A	2 MOPP ¹	IIIb ²	400	565	12.0	7.0	12.0	9.0

¹ MOPP = Means of Patient Protection

² Materials in the Material Group IIIb have a Comparative Tracking Index (CTI) value between 100 and 175.

12 SCHEMATIC DIAGRAM

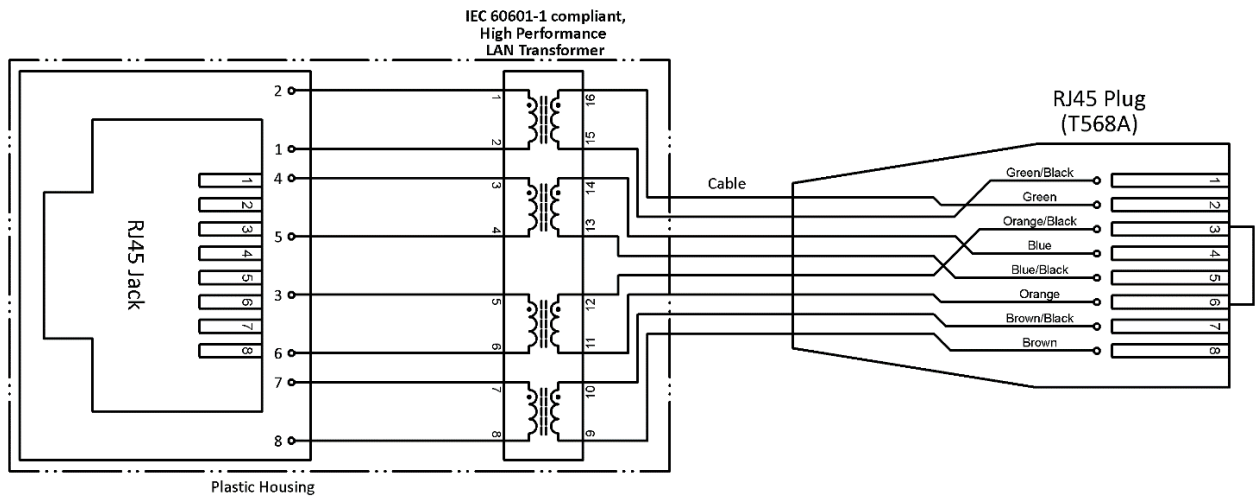

13 PACKAGING





Contents:

- One of: EN-66K or EN-66S
- Installation Guide

A packaging label provides the following information:

- Article Description
- Quantity
- Cable Length (for customer specific products)
- Plug Angle (for customer specific products)
- Part Number (PN) (or Order Code (OC) for customer specific products)
- Date of Manufacture
- Serial Number (SN)
- The Serial Number is printed as both a linear (Code 128) and a 2-D Barcode (Data Matrix)

14 PRODUCT MARKINGS

	Through this mark, the conformity of the product with all applicable EU Directives is confirmed.
	Designates the product as a UL "Recognized Component"; File number E362969.
	The product may not be disposed of in domestic rubbish.
	This product contains no substances containing lead and is manufactured using lead-free solder.
	This product meets the requirements of EU Directive concerning the limitation of the use of certain hazardous substances in electric and electronic equipment.

15 SCHEDULED MAINTENANCE

When used as directed, EMOSAFE Network Isolators are maintenance-free.

16 ENVIRONMENTAL PROTECTION INFORMATION

This device contains electronic components. At the end of its service life it is to be returned to the manufacturer for disposal.

17 QUALITY

EMO Systems operates a certified quality management system for development and production in accordance with ISO 9001 and ISO 13485. Prior to delivery, each Network Isolator is subjected to a comprehensive quality inspection. This inspection ensures, among other factors, that the attained values for leakage currents, dielectric withstand strengths, insertion losses, return losses, and near end crosstalk values all meet the specified requirements.

18 CONTACT AND SUPPORT

Please find our up-to-date contact details on our website: <http://www.emosystems.de/en/contact>

Or send us an e-mail at the following address: support@emosystems.de

19 LEGAL NOTIFICATION

The information provided above in this datasheet has been compiled with all due care and is believed to be accurate and reliable. However, we cannot guarantee that the information contained is completely free from error. The end user is responsible and liable for the proper use of this product. EMO Systems GmbH assumes no liability. We reserve the right to make changes to this datasheet without notice.