

N-Channel Enhancement-Mode Vertical DMOS FET

Features

- 1.6V Maximum Low Threshold
- High Input Impedance
- 125 pF Maximum Low Input Capacitance
- Fast Switching Speeds
- Low On-Resistance
- Free from Secondary Breakdown
- Low Input and Output Leakage

Applications

- Logic-Level Interfaces (Ideal for TTL and CMOS)
- Solid-State Relays
- Battery-Operated Systems
- Photovoltaic Drives
- Analog Switches
- General Purpose Line Drivers
- Telecommunication Switches

General Description

The TN2504 low-threshold Enhancement-mode (normally-off) transistor uses a vertical DMOS structure and a well-proven silicon-gate manufacturing process. This combination produces a device with the power handling capabilities of bipolar transistors and the high input impedance and positive temperature coefficient inherent in MOS devices. Characteristic of all MOS structures, this device is free from thermal runaway and thermally induced secondary breakdown.

Microchip's vertical DMOS FETs are ideally suited to a wide range of switching and amplifying applications where very low threshold voltage, high breakdown voltage, high input impedance, low input capacitance, and fast switching speeds are desired.

Package Type

3-lead SOT-89
(Top view)

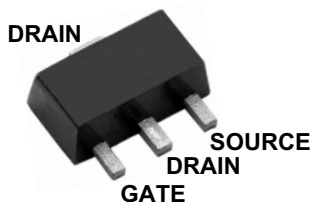

See [Table 3-1](#) for pin information.

TN2504

1.0 ELECTRICAL CHARACTERISTICS

Absolute Maximum Ratings†

| | |
|--|-----------------------------------|
| Drain-to-Source Voltage | BV_{DSS} |
| Drain-to-Gate Voltage | BV_{DGS} |
| Gate-to-Source Voltage | $\pm 20V$ |
| Operating Ambient Temperature, T_A | $-55^{\circ}C$ to $+150^{\circ}C$ |
| Storage Temperature, T_S | $-55^{\circ}C$ to $+150^{\circ}C$ |

† **Notice:** Stresses above those listed under “Absolute Maximum Ratings” may cause permanent damage to the device. This is a stress rating only, and functional operation of the device at those or any other conditions above those indicated in the operational sections of this specification is not intended. Exposure to maximum rating conditions for extended periods may affect device reliability.

DC ELECTRICAL CHARACTERISTICS

Electrical Specifications: $T_A = 25^{\circ}C$ unless otherwise specified. All DC parameters are 100% tested at $25^{\circ}C$ unless otherwise stated. (Pulse test: 300 μs pulse, 2% duty cycle)

| Parameter | Sym. | Min. | Typ. | Max. | Unit | Conditions |
|--|---------------------|------|------|------|-----------------|--|
| Drain-to-Source Breakdown Voltage | BV_{DSS} | 40 | — | — | V | $V_{GS} = 0V, I_D = 2\text{ mA}$ |
| Gate Threshold Voltage | $V_{GS(th)}$ | 0.6 | — | 1.6 | V | $V_{GS} = V_{DS}, I_D = 1\text{ mA}$ |
| Change in $V_{GS(th)}$ with Temperature | $\Delta V_{GS(th)}$ | — | -3.8 | -4.5 | mV/ $^{\circ}C$ | $V_{GS} = V_{DS}, I_D = 1\text{ mA}$ (Note 1) |
| Gate Body Leakage Current | I_{GSS} | — | — | 100 | nA | $V_{GS} = \pm 20V, V_{DS} = 0V$ |
| Zero-Gate Voltage Drain Current | I_{DSS} | — | — | 10 | μA | $V_{GS} = 0V,$ $V_{DS} = \text{Maximum rating}$ |
| | | — | — | 1 | mA | $V_{DS} = 0.8 \text{ Maximum rating},$ $V_{GS} = 0V, T_A = 125^{\circ}C$ (Note 1) |
| On-State Drain Current | $I_{D(ON)}$ | 1 | 1.7 | — | A | $V_{GS} = 5V, V_{DS} = 15V$ |
| | | 4 | 4.5 | — | A | $V_{GS} = 10V, V_{DS} = 15V$ |
| Static Drain-to-Source On-State Resistance | $R_{DS(ON)}$ | — | 1.25 | 1.5 | Ω | $V_{GS} = 5V, I_D = 300\text{ mA}$ |
| | | — | 0.8 | 1 | Ω | $V_{GS} = 10V, I_D = 1.5A$ |
| Change in $R_{DS(ON)}$ with Temperature | $\Delta R_{DS(ON)}$ | — | — | 0.75 | %/ $^{\circ}C$ | $V_{GS} = 10V, I_D = 1.5A$ (Note 1) |

Note 1: Specification is obtained by characterization and is not 100% tested.

AC ELECTRICAL CHARACTERISTICS

Electrical Specifications: $T_A = 25^\circ\text{C}$ unless otherwise specified. All AC parameters are not 100% sample tested.

| Parameter | Sym. | Min. | Typ. | Max. | Unit | Conditions |
|----------------------------------|--------------|------|------|------|------|---|
| Forward Transconductance | G_{FS} | 500 | 700 | — | mmho | $V_{DS} = 15\text{V}, I_D = 2\text{A}$ |
| Input Capacitance | C_{ISS} | — | 70 | 125 | pF | $V_{GS} = 0\text{V},$ $V_{DS} = 20\text{V},$ $f = 1\text{MHz}$ |
| Common-Source Output Capacitance | C_{OSS} | — | 50 | 70 | pF | |
| Reverse Transfer Capacitance | C_{RSS} | — | 20 | 25 | pF | |
| Turn-On Delay Time | $t_{d(ON)}$ | — | — | 10 | ns | $V_{DD} = 20\text{V},$ $I_D = 500\text{mA},$ $R_{GEN} = 25\Omega$ |
| Rise Time | t_r | — | — | 10 | ns | |
| Turn-Off Delay Time | $t_{d(OFF)}$ | — | — | 25 | ns | |
| Fall Time | t_f | — | — | 13 | ns | |
| DIODE PARAMETER | | | | | | |
| Diode Forward Voltage Drop | V_{SD} | — | 1.2 | 1.8 | V | $V_{GS} = 0\text{V}, I_{SD} = 1.5\text{A}$ (Note 1) |
| Reverse Recovery Time | t_{rr} | — | 300 | — | ns | $V_{GS} = 0\text{V}, I_{SD} = 1\text{mA}$ |

Note 1: All DC parameters are 100% tested at 25°C unless otherwise stated.
(Pulse test: 300 μs pulse, 2% duty cycle)

TEMPERATURE SPECIFICATIONS

| Parameter | Sym. | Min. | Typ. | Max. | Unit | Conditions |
|-----------------------------------|---------------|------|------|------|--------------------|------------|
| TEMPERATURE RANGE | | | | | | |
| Operating Ambient Temperature | T_A | -55 | — | +150 | $^\circ\text{C}$ | |
| Storage Temperature | T_S | -55 | — | +150 | $^\circ\text{C}$ | |
| PACKAGE THERMAL RESISTANCE | | | | | | |
| 3-lead SOT-89 | θ_{JA} | — | 73 | — | $^\circ\text{C/W}$ | |

THERMAL CHARACTERISTICS

| Package | I_D (Note 1) (Continuous) (mA) | I_D (Pulsed) (A) | Power Dissipation at $T_A = 25^\circ\text{C}$ (Note 2) (W) | I_{DR} (Note 1) (mA) | I_{DRM} (A) |
|---------------|--|--------------------------|---|---------------------------|------------------|
| 3-lead SOT-89 | 890 | 4.5 | 1.6 | 890 | 4.5 |

Note 1: I_D (continuous) is limited by maximum rated T_J .

2: $T_A = 25^\circ\text{C}$. Mounted on an FR5 Board, 25 mm x 25 mm x 1.57 mm.

2.0 TYPICAL PERFORMANCE CURVES

Note: The graphs and tables provided following this note are a statistical summary based on a limited number of samples and are provided for informational purposes only. The performance characteristics listed herein are not tested or guaranteed. In some graphs or tables, the data presented may be outside the specified operating range (e.g. outside specified power supply range) and therefore outside the warranted range.

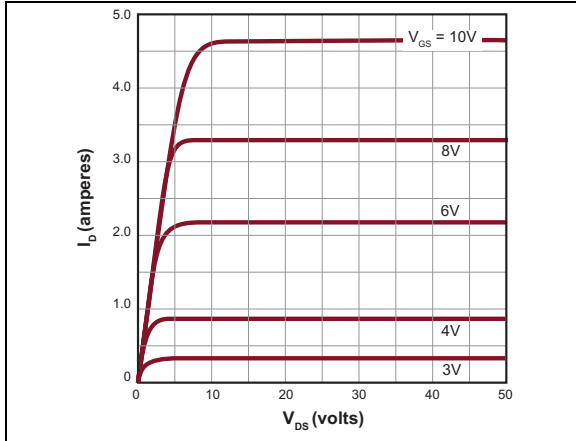

FIGURE 2-1: Output Characteristics.

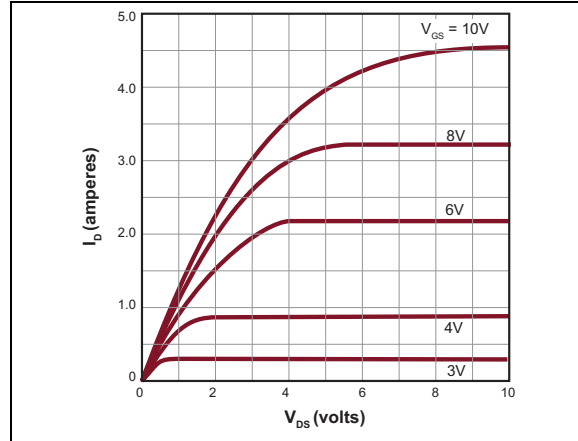

FIGURE 2-4: Saturation Characteristics.

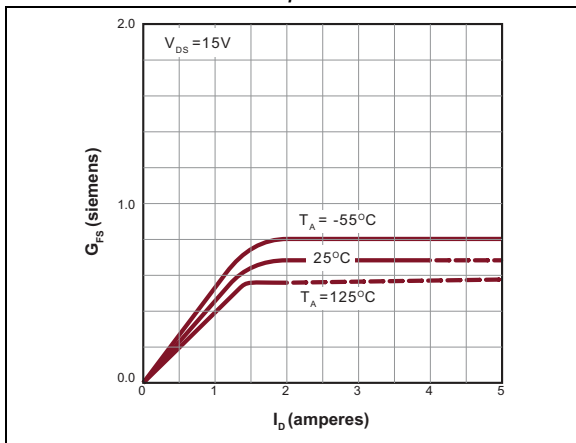

FIGURE 2-2: Transconductance vs. Drain Current.

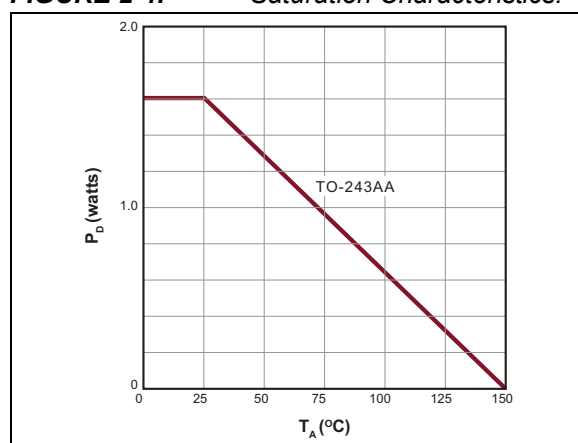

FIGURE 2-5: Power Dissipation vs. Ambient Temperature.

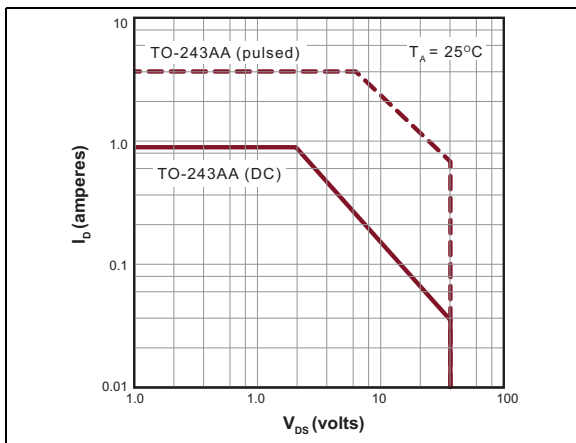

FIGURE 2-3: Maximum Rated Safe Operating Area.

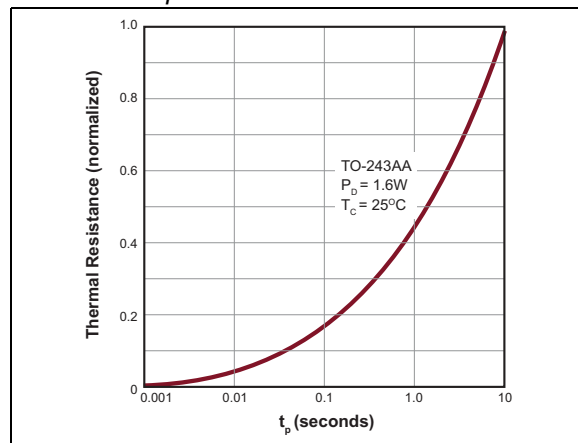

FIGURE 2-6: Thermal Response Characteristics.

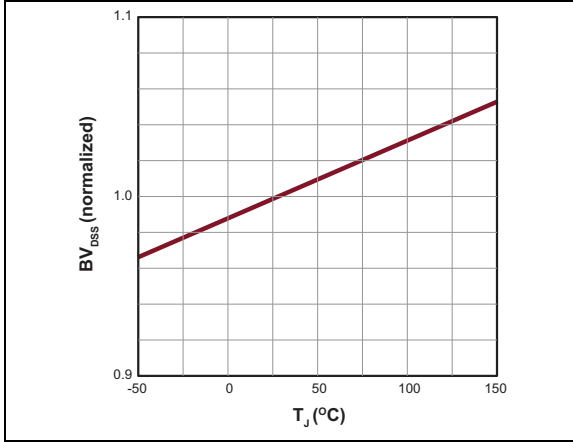

FIGURE 2-7: BV_{DSS} Variation with Temperature.

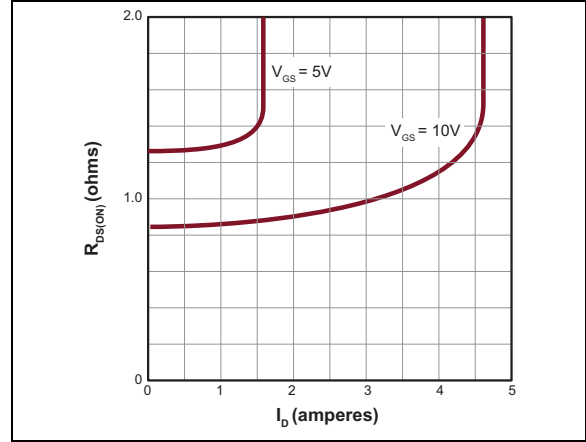

FIGURE 2-10: On-Resistance vs. Drain Current.

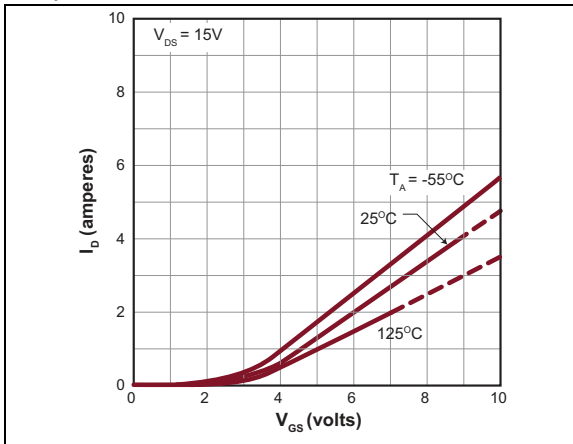

FIGURE 2-8: Transfer Characteristics.

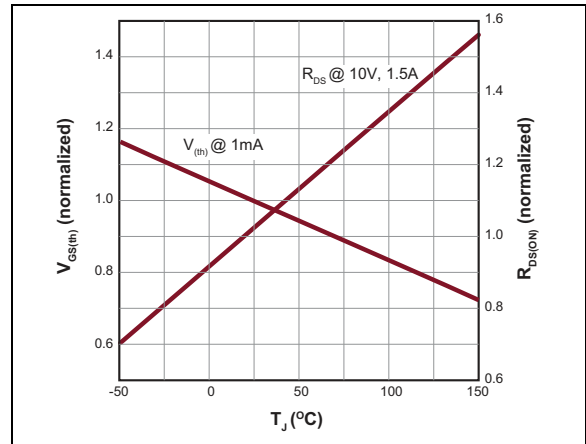

FIGURE 2-11: $V_{GS(th)}$ and $R_{DS(ON)}$ with Temperature.

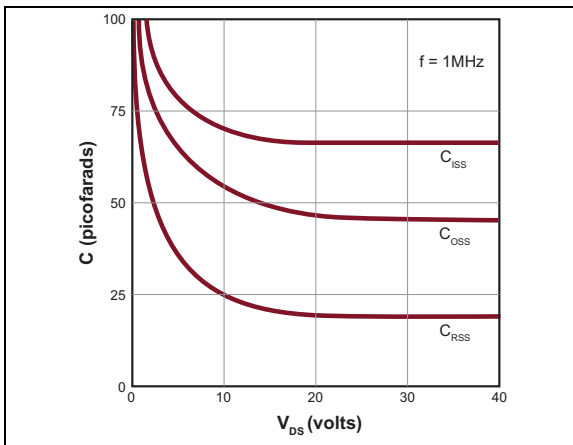

FIGURE 2-9: Capacitance vs. Drain-to-Source Voltage.

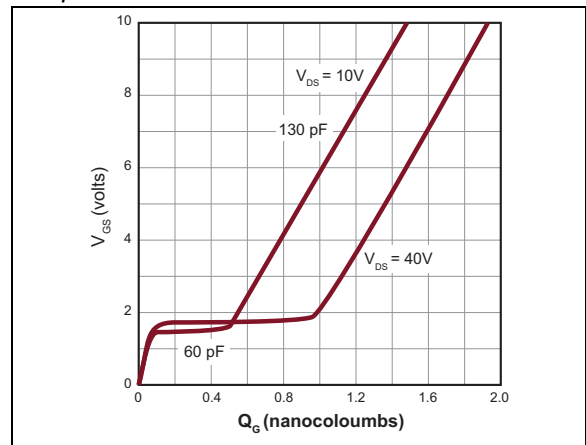

FIGURE 2-12: Gate Drive Dynamic Characteristics.

TN2504

3.0 PIN DESCRIPTION

Table 3-1 shows details on the pins of TN2504. Refer to [Package Type](#) for the location of the pins.

TABLE 3-1: PIN FUNCTION TABLE

| Pin Number | Pin Name | Description |
|------------|----------|-------------|
| 1 | Gate | Gate |
| 2,4 | Drain | Drain |
| 3 | Source | Source |

4.0 FUNCTIONAL DESCRIPTION

Figure 4-1 illustrates the switching waveforms and test circuit for TN2504.

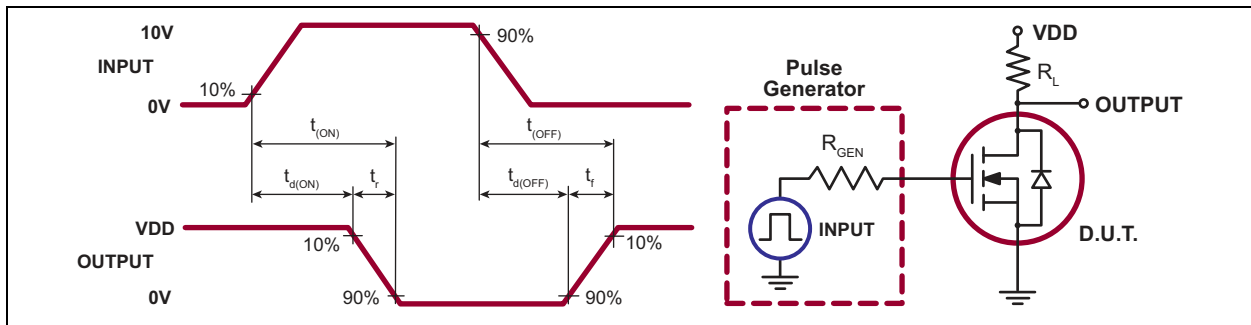

FIGURE 4-1: Switching Waveforms and Test Circuit.

TABLE 4-1: PRODUCT SUMMARY

| BV_{DSS}/BV_{DGS} (V) | $R_{DS(ON)}$ (Maximum) (Ω) | $I_{D(ON)}$ (Minimum) (A) | $V_{GS(TH)}$ (Maximum) (V) |
|----------------------------|---|---------------------------------|----------------------------------|
| 40 | 1 | 4 | 1.6 |

TN2504

5.0 PACKAGING INFORMATION

5.1 Package Marking Information

3-lead SOT-89

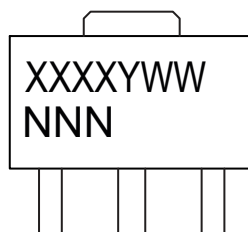

Example

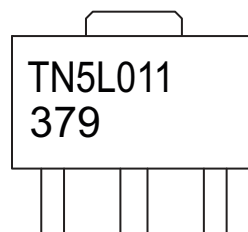

| | | |
|----------------|--------|--|
| Legend: | XX...X | Product Code or Customer-specific information |
| | Y | Year code (last digit of calendar year) |
| | YY | Year code (last 2 digits of calendar year) |
| | WW | Week code (week of January 1 is week '01') |
| | NNN | Alphanumeric traceability code |
| | (e3) | Pb-free JEDEC® designator for Matte Tin (Sn) |
| | * | This package is Pb-free. The Pb-free JEDEC designator (e3) can be found on the outer packaging for this package. |

Note: In the event the full Microchip part number cannot be marked on one line, it will be carried over to the next line, thus limiting the number of available characters for product code or customer-specific information. Package may or not include the corporate logo.

3-Lead TO-243AA (SOT-89) Package Outline (N8)

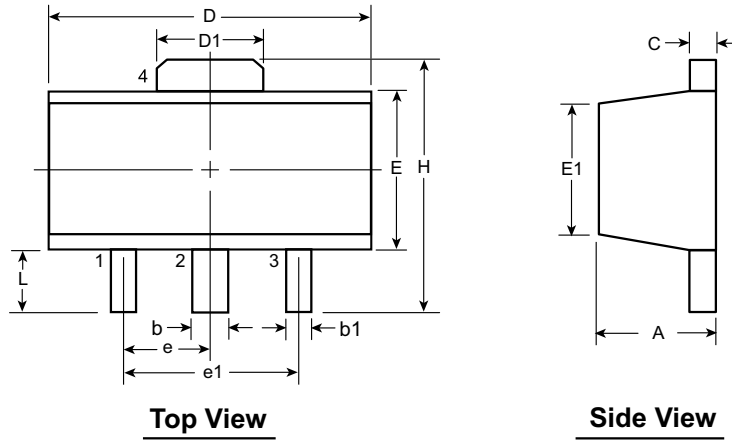

Note: For the most current package drawings, see the Microchip Packaging Specification at www.microchip.com/packaging.

| Symbol | | A | b | b1 | C | D | D1 | E | E1 | e | e1 | H | L |
|--------------------|-----|------|------|------|------|------|------|------|-------------------|-------------|-------------|------|-------------------|
| Dimensions (mm) | MIN | 1.40 | 0.44 | 0.36 | 0.35 | 4.40 | 1.62 | 2.29 | 2.00 [†] | 1.50 BSC | 3.00 BSC | 3.94 | 0.73 [†] |
| | NOM | - | - | - | - | - | - | - | - | | | - | - |
| | MAX | 1.60 | 0.56 | 0.48 | 0.44 | 4.60 | 1.83 | 2.60 | 2.29 | | | 4.25 | 1.20 |

JEDEC Registration TO-243, Variation AA, Issue C, July 1986.

[†] This dimension differs from the JEDEC drawing

Drawings not to scale.

TN2504

NOTES:

APPENDIX A: REVISION HISTORY

Revision A (November 2020)

- Converted Supertex Doc# DSFP-TN2504 to Microchip DS20005949A
- Changed the package marking format
- Made minor text changes throughout the document

TN2504

PRODUCT IDENTIFICATION SYSTEM

To order or obtain information, e.g., on pricing or delivery, contact your local Microchip representative or sales office.

| <u>PART NO.</u> | <u>XX</u> | - | <u>X</u> | - | <u>X</u> |
|-----------------|-----------------|---|--|---|------------|
| Device | Package Options | | Environmental | | Media Type |
| Device: | TN2504 | = | N-Channel Enhancement-Mode Vertical DMOS FET | | |
| Package: | N8 | = | 3-lead SOT-89 | | |
| Environmental: | G | = | Lead (Pb)-free/RoHS-compliant Package | | |
| Media Type: | (blank) | = | 2000/Reel for an N8 Package | | |

Example:

a) TN2504N8-G: N-Channel Enhancement-Mode, Vertical DMOS FET, 3-lead SOT-89, 2000/Reel

Note the following details of the code protection feature on Microchip devices:

- Microchip products meet the specifications contained in their particular Microchip Data Sheet.
- Microchip believes that its family of products is secure when used in the intended manner and under normal conditions.
- There are dishonest and possibly illegal methods being used in attempts to breach the code protection features of the Microchip devices. We believe that these methods require using the Microchip products in a manner outside the operating specifications contained in Microchip's Data Sheets. Attempts to breach these code protection features, most likely, cannot be accomplished without violating Microchip's intellectual property rights.
- Microchip is willing to work with any customer who is concerned about the integrity of its code.
- Neither Microchip nor any other semiconductor manufacturer can guarantee the security of its code. Code protection does not mean that we are guaranteeing the product is "unbreakable." Code protection is constantly evolving. We at Microchip are committed to continuously improving the code protection features of our products. Attempts to break Microchip's code protection feature may be a violation of the Digital Millennium Copyright Act. If such acts allow unauthorized access to your software or other copyrighted work, you may have a right to sue for relief under that Act.

Information contained in this publication is provided for the sole purpose of designing with and using Microchip products. Information regarding device applications and the like is provided only for your convenience and may be superseded by updates. It is your responsibility to ensure that your application meets with your specifications.

THIS INFORMATION IS PROVIDED BY MICROCHIP "AS IS". MICROCHIP MAKES NO REPRESENTATIONS OR WARRANTIES OF ANY KIND WHETHER EXPRESS OR IMPLIED, WRITTEN OR ORAL, STATUTORY OR OTHERWISE, RELATED TO THE INFORMATION INCLUDING BUT NOT LIMITED TO ANY IMPLIED WARRANTIES OF NON-INFRINGEMENT, MERCHANTABILITY, AND FITNESS FOR A PARTICULAR PURPOSE OR WARRANTIES RELATED TO ITS CONDITION, QUALITY, OR PERFORMANCE.

IN NO EVENT WILL MICROCHIP BE LIABLE FOR ANY INDIRECT, SPECIAL, PUNITIVE, INCIDENTAL OR CONSEQUENTIAL LOSS, DAMAGE, COST OR EXPENSE OF ANY KIND WHATSOEVER RELATED TO THE INFORMATION OR ITS USE, HOWEVER CAUSED, EVEN IF MICROCHIP HAS BEEN ADVISED OF THE POSSIBILITY OR THE DAMAGES ARE FORESEEABLE. TO THE FULLEST EXTENT ALLOWED BY LAW, MICROCHIP'S TOTAL LIABILITY ON ALL CLAIMS IN ANY WAY RELATED TO THE INFORMATION OR ITS USE WILL NOT EXCEED THE AMOUNT OF FEES, IF ANY, THAT YOU HAVE PAID DIRECTLY TO MICROCHIP FOR THE INFORMATION. Use of Microchip devices in life support and/or safety applications is entirely at the buyer's risk, and the buyer agrees to defend, indemnify and hold harmless Microchip from any and all damages, claims, suits, or expenses resulting from such use. No licenses are conveyed, implicitly or otherwise, under any Microchip intellectual property rights unless otherwise stated.

Trademarks

The Microchip name and logo, the Microchip logo, Adaptec, AnyRate, AVR, AVR logo, AVR Freaks, BesTime, BitCloud, chipKIT, chipKIT logo, CryptoMemory, CryptoRF, dsPIC, FlashFlex, flexPWR, HELDO, IGL00, JukeBlox, KeeLoq, Klear, LANCheck, LinkMD, maXStylus, maXTouch, MediaLB, megaAVR, Microsemi, Microsemi logo, MOST, MOST logo, MPLAB, OptoLyzr, PackeTime, PIC, picoPower, PICSTART, PIC32 logo, PolarFire, Prochip Designer, QTouch, SAM-BA, SenGenuity, SpyNIC, SST, SST Logo, SuperFlash, Symmetricom, SyncServer, Tachyon, TimeSource, tinyAVR, UNI/O, Vectron, and XMEGA are registered trademarks of Microchip Technology Incorporated in the U.S.A. and other countries.

AgileSwitch, APT, ClockWorks, The Embedded Control Solutions Company, EtherSynch, FlashTec, Hyper Speed Control, HyperLight Load, IntelliMOS, Libero, motorBench, mTouch, Powermite 3, Precision Edge, ProASIC, ProASIC Plus, ProASIC Plus logo, Quiet-Wire, SmartFusion, SyncWorld, Temux, TimeCesium, TimeHub, TimePictra, TimeProvider, WinPath, and ZL are registered trademarks of Microchip Technology Incorporated in the U.S.A.

Adjacent Key Suppression, AKS, Analog-for-the-Digital Age, Any Capacitor, AnyIn, AnyOut, Augmented Switching, BlueSky, BodyCom, CodeGuard, CryptoAuthentication, CryptoAutomotive, CryptoCompanion, CryptoController, dsPICDEM, dsPICDEM.net, Dynamic Average Matching, DAM, ECAN, Espresso T1S, EtherGREEN, IdealBridge, In-Circuit Serial Programming, ICSP, INICnet, Intelligent Paralleling, Inter-Chip Connectivity, JitterBlocker, maxCrypto, maxView, memBrain, Mindi, MiWi, MPASM, MPF, MPLAB Certified logo, MPLIB, MPLINK, MultiTRAK, NetDetach, Omniscient Code Generation, PICDEM, PICDEM.net, PICkit, PICtail, PowerSmart, PureSilicon, QMatrix, REAL ICE, Ripple Blocker, RTAX, RTG4, SAM-ICE, Serial Quad I/O, simpleMAP, SimpliPHY, SmartBuffer, SMART-I.S., storClad, SQI, SuperSwitcher, SuperSwitcher II, Switchtec, SynchroPHY, Total Endurance, TSHARC, USBCheck, VariSense, VectorBlox, VeriPHY, ViewSpan, WiperLock, XpressConnect, and ZENA are trademarks of Microchip Technology Incorporated in the U.S.A. and other countries.

SQTP is a service mark of Microchip Technology Incorporated in the U.S.A.

The Adaptec logo, Frequency on Demand, Silicon Storage Technology, and Symmcom are registered trademarks of Microchip Technology Inc. in other countries.

GestIC is a registered trademark of Microchip Technology Germany II GmbH & Co. KG, a subsidiary of Microchip Technology Inc., in other countries.

All other trademarks mentioned herein are property of their respective companies.

© 2020, Microchip Technology Incorporated, All Rights Reserved.

ISBN: 978-1-5224-7121-9

For information regarding Microchip's Quality Management Systems, please visit www.microchip.com/quality.



MICROCHIP

Worldwide Sales and Service

AMERICAS

Corporate Office

2355 West Chandler Blvd.
Chandler, AZ 85224-6199

Tel: 480-792-7200

Fax: 480-792-7277

Technical Support:

[http://www.microchip.com/
support](http://www.microchip.com/support)

Web Address:

www.microchip.com

Atlanta

Duluth, GA

Tel: 678-957-9614

Fax: 678-957-1455

Austin, TX

Tel: 512-257-3370

Boston

Westborough, MA

Tel: 774-760-0087

Fax: 774-760-0088

Chicago

Itasca, IL

Tel: 630-285-0071

Fax: 630-285-0075

Dallas

Addison, TX

Tel: 972-818-7423

Fax: 972-818-2924

Detroit

Novi, MI

Tel: 248-848-4000

Houston, TX

Tel: 281-894-5983

Indianapolis

Noblesville, IN

Tel: 317-773-8323

Fax: 317-773-5453

Tel: 317-536-2380

Los Angeles

Mission Viejo, CA

Tel: 949-462-9523

Fax: 949-462-9608

Tel: 951-273-7800

Raleigh, NC

Tel: 919-844-7510

New York, NY

Tel: 631-435-6000

San Jose, CA

Tel: 408-735-9110

Tel: 408-436-4270

Canada - Toronto

Tel: 905-695-1980

Fax: 905-695-2078

ASIA/PACIFIC

Australia - Sydney

Tel: 61-2-9868-6733

China - Beijing

Tel: 86-10-8569-7000

China - Chengdu

Tel: 86-28-8665-5511

China - Chongqing

Tel: 86-23-8980-9588

China - Dongguan

Tel: 86-769-8702-9880

China - Guangzhou

Tel: 86-20-8755-8029

China - Hangzhou

Tel: 86-571-8792-8115

China - Hong Kong SAR

Tel: 852-2943-5100

China - Nanjing

Tel: 86-25-8473-2460

China - Qingdao

Tel: 86-532-8502-7355

China - Shanghai

Tel: 86-21-3326-8000

China - Shenyang

Tel: 86-24-2334-2829

China - Shenzhen

Tel: 86-755-8864-2200

China - Suzhou

Tel: 86-186-6233-1526

China - Wuhan

Tel: 86-27-5980-5300

China - Xian

Tel: 86-29-8833-7252

China - Xiamen

Tel: 86-592-2388138

China - Zhuhai

Tel: 86-756-3210040

ASIA/PACIFIC

India - Bangalore

Tel: 91-80-3090-4444

India - New Delhi

Tel: 91-11-4160-8631

India - Pune

Tel: 91-20-4121-0141

Japan - Osaka

Tel: 81-6-6152-7160

Japan - Tokyo

Tel: 81-3-6880-3770

Korea - Daegu

Tel: 82-53-744-4301

Korea - Seoul

Tel: 82-2-554-7200

Malaysia - Kuala Lumpur

Tel: 60-3-7651-7906

Malaysia - Penang

Tel: 60-4-227-8870

Philippines - Manila

Tel: 63-2-634-9065

Singapore

Tel: 65-6334-8870

Taiwan - Hsin Chu

Tel: 886-3-577-8366

Taiwan - Kaohsiung

Tel: 886-7-213-7830

Taiwan - Taipei

Tel: 886-2-2508-8600

Thailand - Bangkok

Tel: 66-2-694-1351

Vietnam - Ho Chi Minh

Tel: 84-28-5448-2100

EUROPE

Austria - Wels

Tel: 43-7242-2244-39

Fax: 43-7242-2244-393

Denmark - Copenhagen

Tel: 45-4485-5910

Fax: 45-4485-2829

Finland - Espoo

Tel: 358-9-4520-820

France - Paris

Tel: 33-1-69-53-63-20

Fax: 33-1-69-30-90-79

Germany - Garching

Tel: 49-8931-9700

Germany - Haan

Tel: 49-2129-3766400

Germany - Heilbronn

Tel: 49-7131-72400

Germany - Karlsruhe

Tel: 49-721-625370

Germany - Munich

Tel: 49-89-627-144-0

Fax: 49-89-627-144-44

Germany - Rosenheim

Tel: 49-8031-354-560

Israel - Ra'anana

Tel: 972-9-744-7705

Italy - Milan

Tel: 39-0331-742611

Fax: 39-0331-466781

Italy - Padova

Tel: 39-049-7625286

Netherlands - Drunen

Tel: 31-416-690399

Fax: 31-416-690340

Norway - Trondheim

Tel: 47-7288-4388

Poland - Warsaw

Tel: 48-22-3325737

Romania - Bucharest

Tel: 40-21-407-87-50

Spain - Madrid

Tel: 34-91-708-08-90

Fax: 34-91-708-08-91

Sweden - Gothenberg

Tel: 46-31-704-60-40

Sweden - Stockholm

Tel: 46-8-5090-4654

UK - Wokingham

Tel: 44-118-921-5800

Fax: 44-118-921-5820